

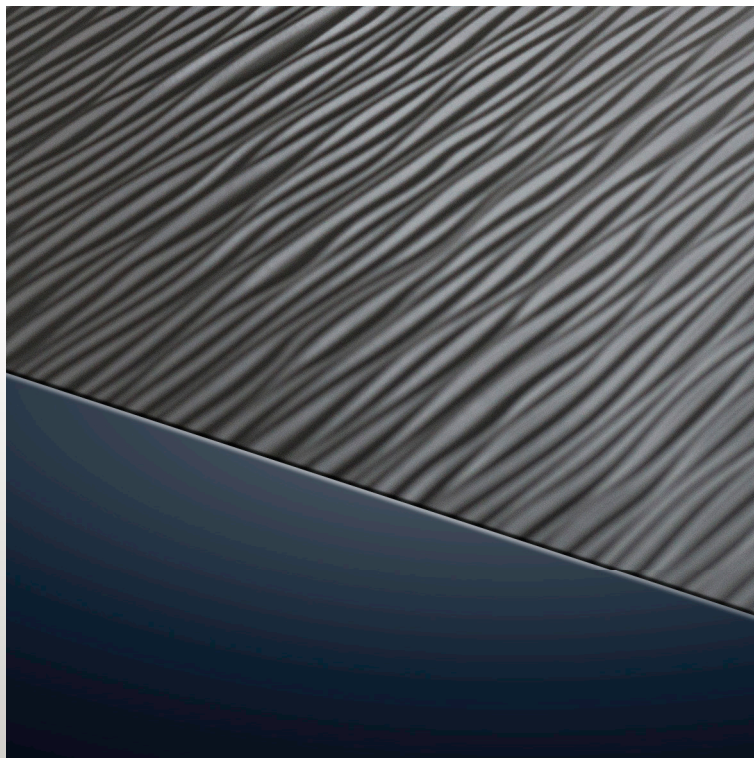

**Aluform**<sup>®</sup>  
FORMA E SOSTANZA



*I dettagli fanno la perfezione  
e la perfezione non è un dettaglio.*

*Leonardo da Vinci*

# RUBRICA

INDICE DI ORIENTAMENTO

## INFINITY

COLLECTION



PAG. 14

## STYLE

COLLECTION



PAG. 50

## A FILO

COLLECTION



PAG. 94

## EMOTION

COLLECTION



PAG. 202

## NOVECENTO

COLLECTION



PAG. 282

## INCYSO

COLLECTION



PAG. 406

## VETRI E DECORI



PAG. 456

## MANIGLIE



PAG. 466

## PENSILINE



PAG. 488

## COLORI



PAG. 512

## SEZIONI E SPESSORI



PAG. 522

# Aluform<sup>®</sup>

## Sensazioni che lasciano il segno

Eleganza, raffinatezza, stile, sono l'essenza dei dettagli che colpiscono. Comfort, solidità, resistenza, qualità che contano e fanno la differenza. La porta d'ingresso parla di voi, della vostra storia. È il biglietto da visita che descrive il carattere di una casa e di chi la abita. Le collezioni **Aluform** sono state progettate e realizzate per rappresentarvi ed assecondare tutte le sfumature della vostra personalità, grazie ad un'ampia gamma di combinazioni che vi permetteranno di comporre l'ingresso seguendo i vostri gusti e le vostre esigenze. Soluzioni e sensazioni che non passano inosservate e lasciano il segno.

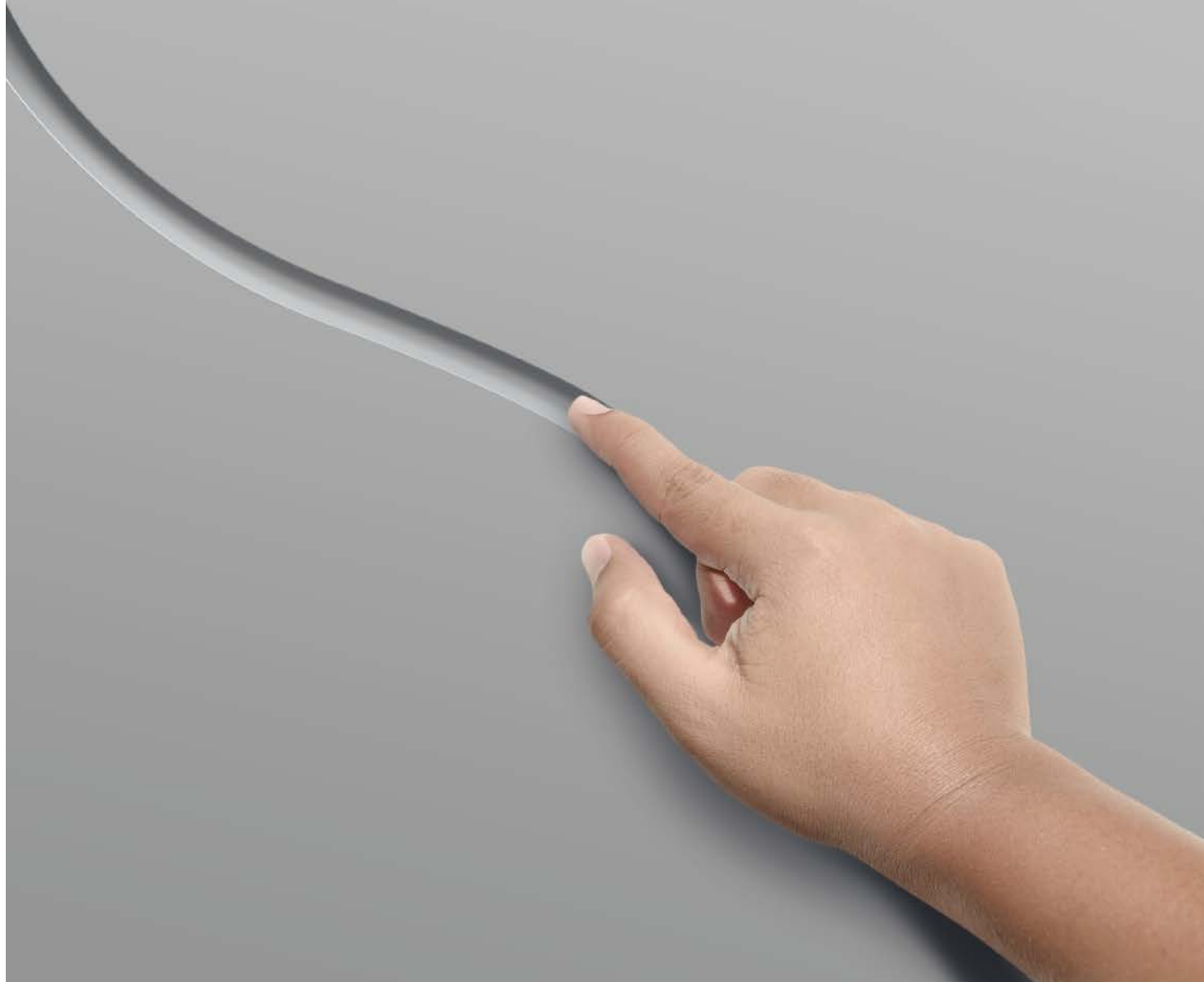

## Creatività e Passione



Solutions for your home

**Royal Pat** è un'azienda italiana nata nel 1981 che fa della propria filosofia un valore imprescindibile. Con il marchio **Aluform** progetta e realizza pannelli termo-decorativi per porte d'ingresso e componenti coordinati, in perfetta armonia con tutto l'ambiente ingresso. Grazie all'impegno, all'esperienza e all'innata capacità di saper creare prodotti innovativi, ricercati ed esclusivi per stile e finiture, **Aluform** è da sempre il punto di riferimento nel settore dei pannelli per porte d'ingresso e sinonimo di valore e professionalità.



## Qualità, Sicurezza e Ambiente

La soddisfazione del cliente, la sicurezza sul lavoro ed il rispetto dell'ambiente sono il nostro obiettivo più importante da sempre. Utilizziamo principalmente materiali riciclabili come l'alluminio e recuperiamo oltre il 95% degli scarti di produzione per dare vita a nuovi prodotti. L'impianto fotovoltaico, installato sul tetto dell'azienda, ci consente una autonomia energetica tale da ridurre di oltre 100 t/anno l'emissione di CO<sup>2</sup> nell'ambiente.

Per la capacità di fornire prodotti e servizi conformi alle attese dei clienti, nel 2000, **Royal Pat** è stata la prima azienda del settore ad ottenere la certificazione del Sistema di Gestione per la Qualità UNI EN ISO 9001. Il percorso continua costantemente con impegno e responsabilità per il conseguimento della certificazioni sulla Sicurezza UNI EN ISO 45001 e sull'Ambiente UNI EN ISO 14001, con l'obiettivo di ottenere, già nel corso del 2019, il Sistema di Gestione Integrato QSA (Qualità, Sicurezza e Ambiente).





LAMPADIE

COMPLEMENTI

PENSILINE

NUMERI CIVICI

VELE ANTIVENTO

VETRI

MANIGLIE

CILINDRI DI SICUREZZA

CASSETTE PER LETTERE

GOCCIOLATOI

## Aluform è l'ingresso Total Look

Non solo pannelli, anche vetri, maniglie, illuminazione a led, chiavi e cilindri di sicurezza, grate, numeri civici, pensiline... Una serie completa di accessori coordinati per completare l'ingresso in perfetta sintonia, per stile e finiture, con la tua porta d'ingresso. Aluform è "l'ambiente ingresso" dal design ricercato, completo e funzionale, ideale per chi non rinuncia alla qualità e si accontenta solo del meglio!



### **SEI** COLLEZIONI

dal design moderno, contemporaneo, classico, vintage, industrial...

### **CINQUE** DISTINTE CONFIGURAZIONI DI PRODOTTO

ognuna con caratteristiche e soluzioni tecniche studiate per rispondere alle specifiche esigenze applicative su porte in Alluminio, Pvc, Alluminio/Legno, Legno/Alluminio, Blindate.

### **OTTOCENTO** MODELLI PER TUTTI I GUSTI E OGNI STILE

la gamma più estesa di modelli e soluzioni inedite dove poter scegliere per stile, requisiti o più semplicemente secondo i propri gusti.

### **CENTOSETTANTA** FINITURE SEMPRE DISPONIBILI

laccati Ral lucidi e grinz, finiture speciali, pellicolati con film tattili, sublimati con tecniche che riproducono fedelmente materiali naturali quali legni e metalli.

### **QUATTROCENTOVENTIMILA** VARIANTI E PERSONALIZZAZIONI POSSIBILI CON UNA SERIE INFINITA DI COMPLEMENTI

per un "ambiente ingresso" nel quale ogni dettaglio si fonde con l'altro in una perfetta armonia di materiali, forme e colori.



---

## **Autentico "Made in Italy"**

---

Royal Pat si distingue per competenza, estro e qualità. È un'azienda dove l'artigianalità, la professionalità e l'entusiasmo di un team attento e preparato si armonizzano con una produzione industriale totalmente interna e rigorosamente "Made in Italy": dalla realizzazione degli stampi allo stampaggio, dalle finiture superficiali alla decorazione dei vetri, dall'assemblaggio all'imballo, fino al trasporto e alla consegna con proprio personale.





---

**Garantito  
anche quando  
non te l'aspetti**

---





La porta d'ingresso è un elemento importante per la casa e deve soddisfare, oltre alle svariate esigenze estetiche, fondamentali requisiti tecnici. In particolare la resistenza agli agenti atmosferici è garantita da diversi strati di trattamento dell'alluminio. Tutte le finiture sono realizzate con impianti interni all'avanguardia, senza uso di cromo e solventi, che assicurano risultati di altissima qualità ed un ciclo di lavorazione a basso impatto ambientale. I pannelli Aluform hanno superato, senza mostrare alcun segno di corrosione, gravosi test di resistenza alla nebbia salina, secondo le modalità dettate dalla norma UNI EN ISO 9227.

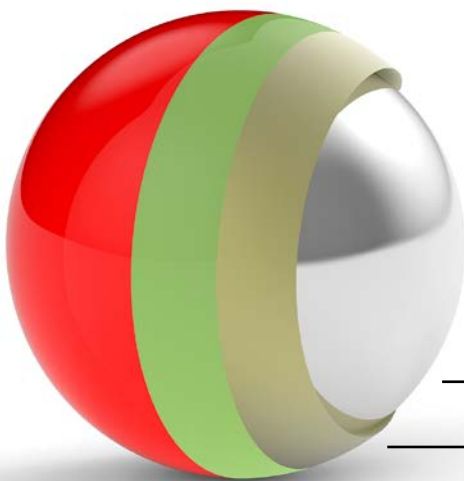

- A)** Lastra in alluminio
- B)** Fosfocromatazione
- C)** Verniciatura protettiva al titanio
- D)** Verniciatura a polveri poliesteri
- E)** Nucleo centrale del pannello

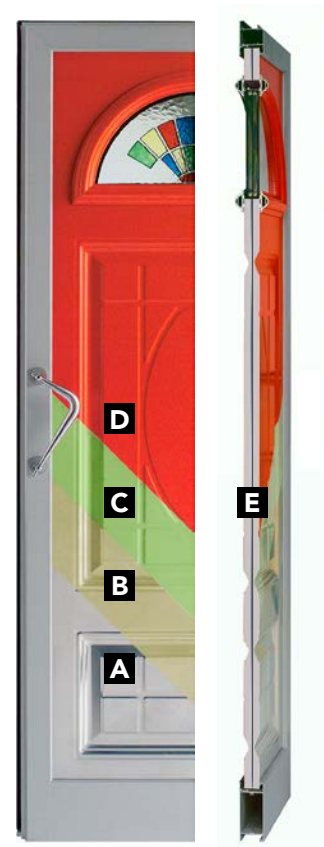

Prodotti per pulire, proteggere e preservare le superfici dei pannelli Aluform

## Lavorazioni ad alta definizione

Passione ed esperienza sono valori che permettono ai pannelli Aluform di conservare fascino e qualità nel tempo. Il segreto per realizzare lavorazioni decorative, con la più alta definizione e precisione sul mercato, è nell'impiego esclusivo di materiali di prima qualità, impianti produttivi all'avanguardia con l'utilizzo di stampi e sistemi di stampaggio tecnologicamente avanzati, frutto di anni di messa a punto. In Royal Pat, sperimentazione, ricerca e messa a punto sono normali attività quotidiane.

 **Aluform**

## Autentici, unici e inconfondibili

Royal Pat, grazie al marchio **Aluform**, si è affermata in Italia nella produzione di componenti e accessori per porte d'ingresso. Una lunga esperienza che si esprime nella capacità di coniugare creatività e processo industriale attraverso il continuo e costante miglioramento. Opera con impegno e professionalità nel rispetto dell'ambiente e della salute delle persone. Dà valore al lavoro di chi, con ingegno e passione, crea soluzioni in grado di interpretare qualsiasi esigenza estetica e funzionale: per questo l'azienda protegge l'originale design di ogni nuovo prodotto con appositi brevetti.

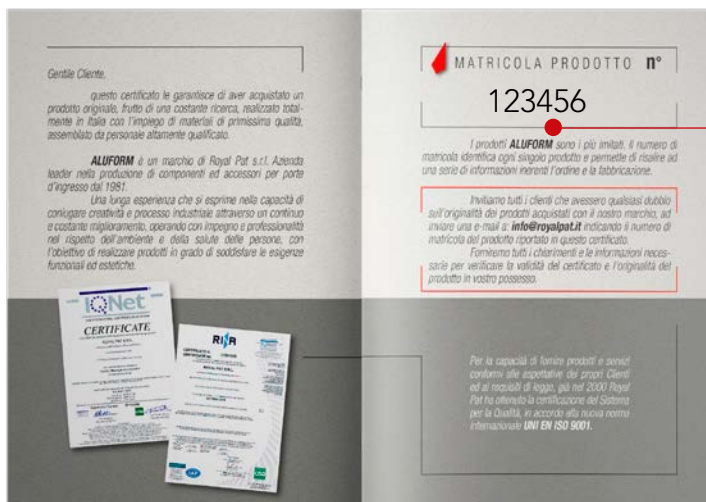

## La carta d'identità Aluform

Insieme al pannello, viene sempre consegnato il certificato di autenticità, un documento atto a garantire l'originalità del prodotto scelto, che permette la tracciabilità del suo iter produttivo. Per qualsiasi dubbio sull'originalità del prodotto acquistato ed avere tutte le informazioni necessarie, è sufficiente inviare una mail a [info@royalpat.it](mailto:info@royalpat.it), indicando il numero di matricola in esso riportato.

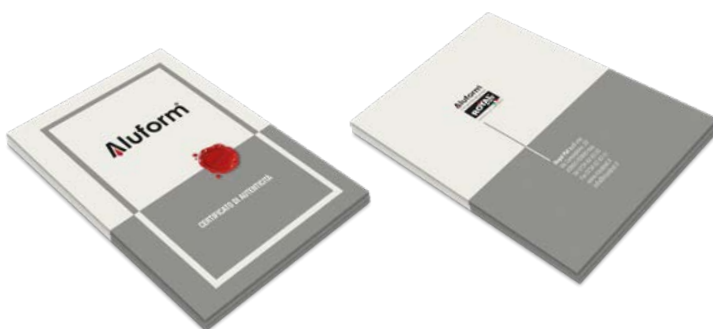

---

## Finalmente a casa

---

Casa dolce casa. Non una frase di circostanza, è il rifugio dal mondo esterno, un luogo dove sentirsi protetti e in pieno comfort. Per questo Royal Pat ha concentrato la propria attenzione in particolare su tre caratteristiche tecniche del prodotto fondamentali, al fine di incidere sull'isolamento termico, acustico e sulla sicurezza. L'importanza di questi tre elementi è avvalorata anche da recenti dati statistici:

- Isolamento termico: tre italiani su quattro prediligono l'acquisto di infissi ed elettrodomestici orientati a limitare i consumi e gli sprechi energetici.
- Abbattimento acustico: ricercato in particolar modo da coloro che, abitando nelle città, attribuiscono al rumore effetti di malessere come la difficoltà di concentrazione, mal di testa, stanchezza, difficoltà a riposare e conseguente aumento dello stress.
- Sicurezza: dal momento che il 27% dei furti in casa avvengono forzando la porta d'ingresso mediante utilizzo di comuni strumenti di scasso, cresce l'esigenza di corredare la propria abitazione di una prima adeguata soluzione di difesa.



## Comfort e serenità

Grazie all'esperienza ed ai continui aggiornamenti tecnici, i pannelli termo-decorativi Aluform sono realizzati con un nuovo nucleo composito extra performante, costituito da un mix di materiali naturali e sintetici, disposti in strati, in grado di garantire eccellenti proprietà di isolamento termico e acustico ed una maggiore robustezza contro i tentativi di intrusione. Nella tabella sottostante è riportata la trasmittanza termica massima degli infissi esposti all'esterno e verso ambienti non climatizzati che sarà in vigore dall'1 Gennaio 2021, già attuale in alcune regioni d'Italia e in tutti gli edifici pubblici.

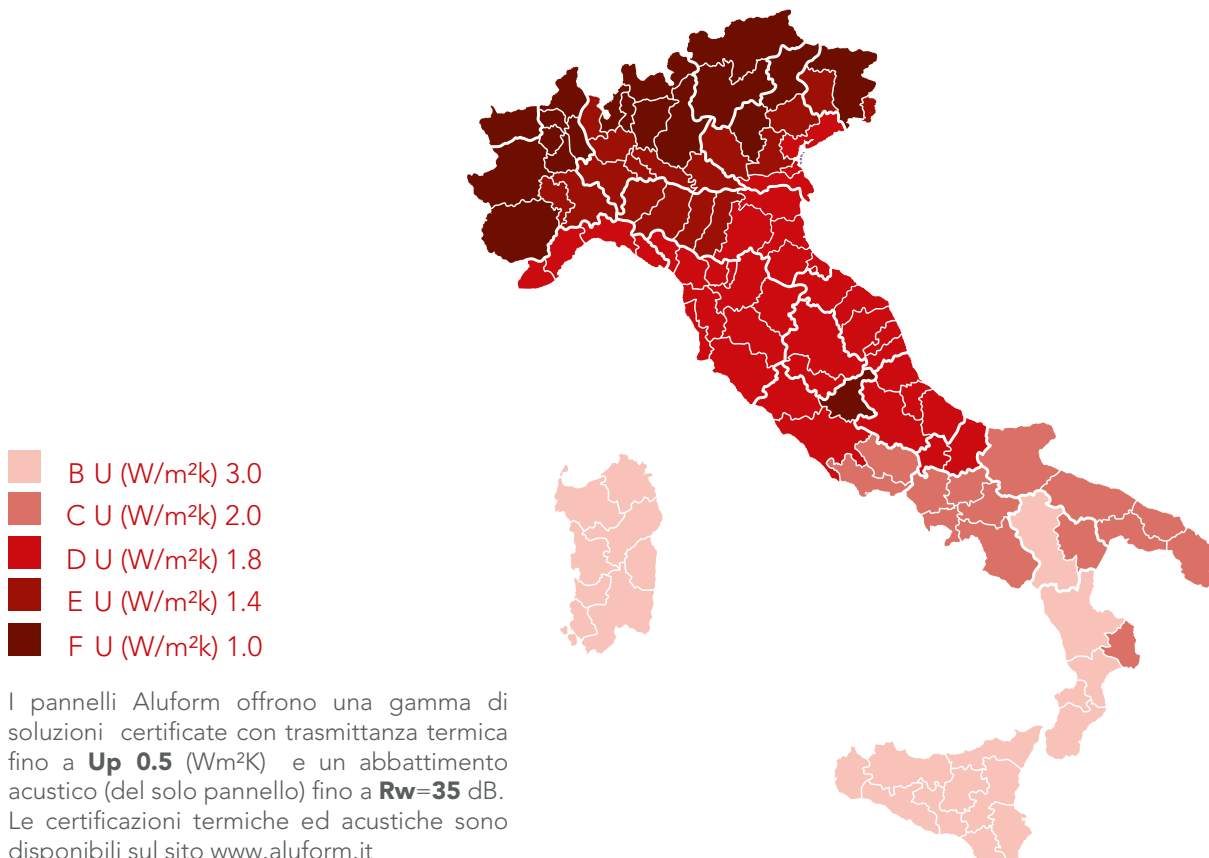
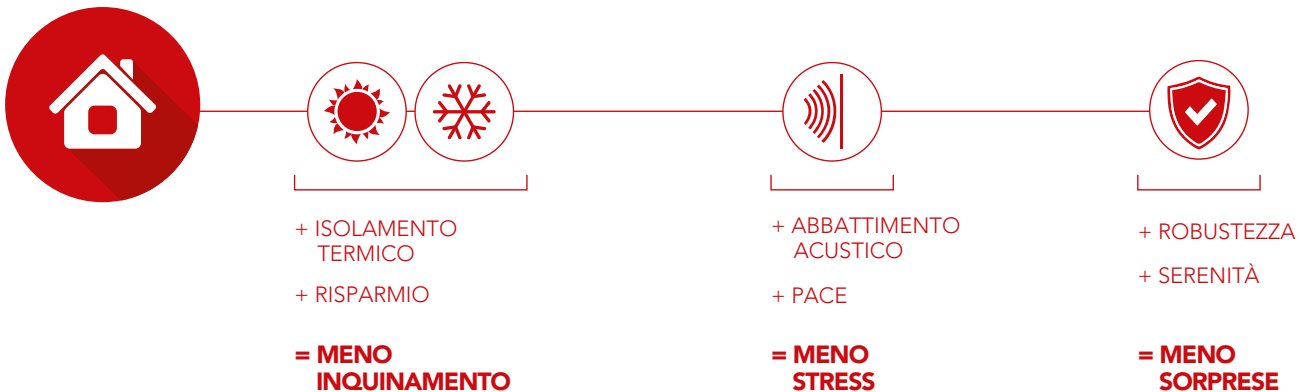

I pannelli Aluform offrono una gamma di soluzioni certificate con trasmittanza termica fino a **Up 0.5** (Wm<sup>2</sup>K) e un abbattimento acustico (del solo pannello) fino a **Rw=35** dB. Le certificazioni termiche ed acustiche sono disponibili sul sito [www.aluform.it](http://www.aluform.it)





Uno sguardo oltre  
l'infinito!

# INFINITY

Superfici levigate si alternano a sinuose increspature dando vita ad un intenso effetto chiaroscuro, ricco di personalità. La collezione Infinity si ispira alle linee morbide ed avvolgenti del deserto con le dune modellate dal vento, che creano giochi di forme e volumi regalando all'ambiente un'atmosfera magica.

INFINITY

STYLE

A FILO

EMOTION

NOVECENTO

INCYSO

VETRI E DECORI

MANIGLIE

PENSILINE

COLORI

SEZ. TECNICA

# INDICE

**ADRAR/H**  
Pag. 45



**ADRAR/MH**  
Pag. 44



**ATACAMA/H**  
Pag. 23



**ATACAMA/MH**  
Pag. 22



**ATACAMA/H1**  
Pag. 25



**ATACAMA/MH1**  
Pag. 25



**ATACAMA/H4**  
Pag. 25



**ATACAMA/MH4**  
Pag. 25



**ATACAMA/H2**  
Pag. 24



**ATACAMA/MH2**  
Pag. 24



**GIBSON/H**  
Pag. 43



**GIBSON/MH**  
Pag. 42



**GOBI/H**  
Pag. 31



**GOBI/MH**  
Pag. 30



**GOBI/H3**  
Pag. 33



**GOBI/MH3**  
Pag. 33



**GOBI/H4**  
Pag. 32



**GOBI/MH4**  
Pag. 32



**GOBI/H1**  
Pag. 33



**GOBI/MH1**  
Pag. 33



**KALAHARI/HD**  
Pag. 35



**KALAHARI/MHD**  
Pag. 34



**MOJAVE/F**  
Pag. 41



**MOJAVE/MF**  
Pag. 40



**SAHARA/H**  
Pag. 19



**SONORA/FD**  
Pag. 36



**SONORA/MFD**  
Pag. 37



**SONORA/FD1**  
Pag. 38



**SONORA/MFD1**  
Pag. 38



**SONORA/FD3**  
Pag. 39



**SONORA/MFD3**  
Pag. 39



**TENERÈ/H**  
Pag. 21



**TENERÈ/MH**  
Pag. 20



**WADIRUM/H**  
Pag. 29



**WADIRUM/H1**  
Pag. 27



**WADIRUM/H4**  
Pag. 27



**WADIRUM/MH**  
Pag. 28



**WADIRUM/MH1**  
Pag. 26



**WADIRUM/MH4**  
Pag. 27





**SAHARA/H**

Colore: RAL 9005 Grinz  
Maniglia: A 955 N  
con illuminazione a led



**SAHARA/H**

Colore: RAL 9016 Grinz  
Maniglia: A 955 N



INFINITY

STYLE

A FILO

EMOTION

NOVECENTO

INCYSO

VETRI E DECORI

MANIGLIE

PENSILINE

COLORI

SEZ. TECNICA

Sahara/HS    Sahara/H

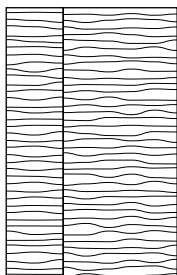

Sahara/HS1    Sahara/H

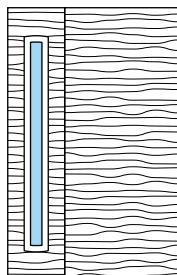



**TENERÈ/MH**

Colore base: RAL 9005 Grinz

2° Colore: RAL 6021 Grinz

Maniglia: A 952 R

**TENERÈ/H**

Colore: RAL 5003 Grinz  
Maniglia: A 952 X (Porpora AK39V Grinz)



**TENERÈ/MH**

Colore base: RAL 9005 Grinz  
2° Colore: Noce RP08L  
Maniglia: A 962 C



INFINITY

STYLE

A FILO

EMOTION

NOVECENTO

INCYSO

VETRI E DECORI

MANIGLIE

PENSILINE

COLORI

SEZ. TECNICA

Sahara/HS Tenerè/H

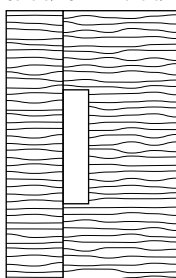

Sahara/HS1 Tenerè/MH

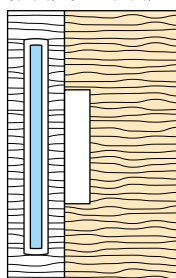



**JOLLY/HS1**

Colore: RAL 9005 lucido  
Vetro: riflette (31)

**ATACAMA/MH**

Colore base: RAL 9005 lucido  
2° colore: RAL 3003 Grinz  
Maniglia: A 972 R con illuminazione a led



**ATACAMA/MH**

Colore base: RAL 8019 Grinz  
2° colore: RAL 7030 Grinz  
Maniglia: A 963 N



**ATACAMA/H**

Colore base: Abete bianco RP14L  
Maniglia: A 972 X (RAL 5003 Grinz)



Sahara/HS1 Atacama/MH

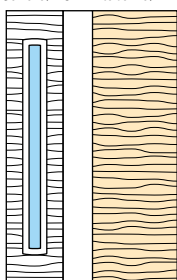

Sahara/HS Atacama/MH

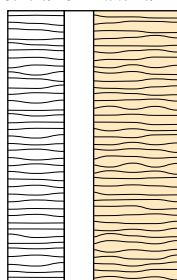

Tablet/YS Atacama/H

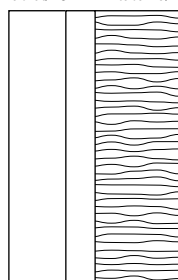

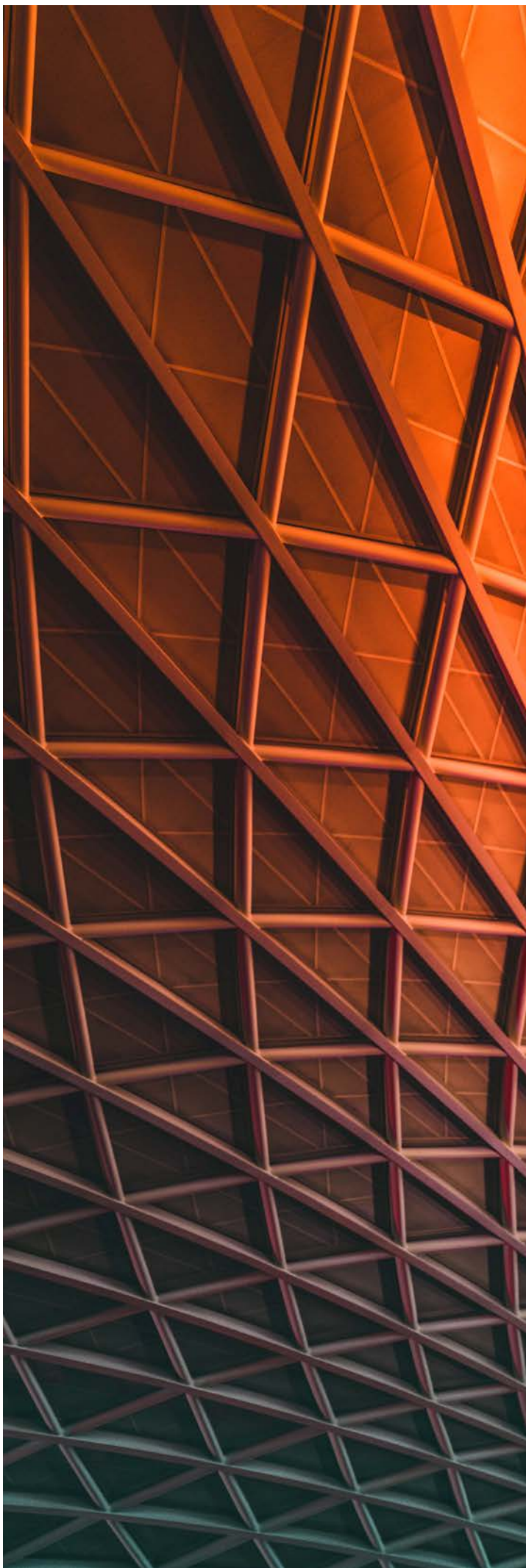

**ATACAMA/MH2**

Colore base: RAL 8019 Grinz

2° colore: Corten V001V Grinz Mix

Vetro: decoro GS (72)

Maniglia: A 953 R



Jolly/HS1 Atacama/MH2

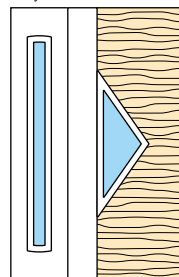

Tablet/YS Atacama/H2

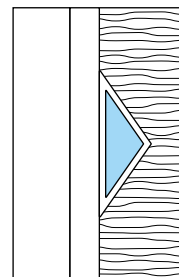

**ATACAMA/H1**

Colore base: RAL 7030 Grinz  
Vetro: decoro GS (31)  
Maniglia: A 622



**ATACAMA/MH4**

Colore base: Bleu AK15V Grinz  
2° colore: Orange AK38V Grinz  
Vetro: rifle (70)  
Maniglia: A 680



Sahara/HS Atacama/H1

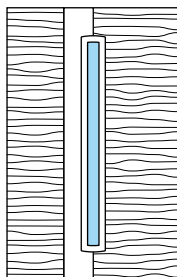

Tablet/YS Atacama/MH1

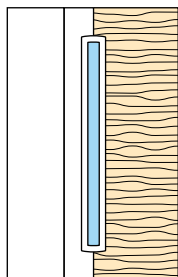

Sahara/HS1 Atacama/MH4

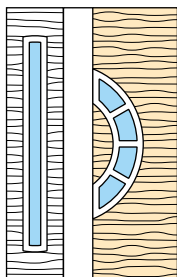

Sahara/HS Atacama/H4

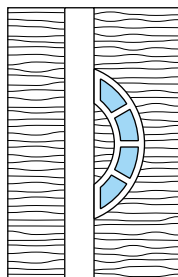



**JOLLY/HS1**

Colore: RAL 5003 lucido  
Vetro: rifle (31)

**WADIRUM/MH1**

Colore base: RAL 5003 lucido  
2° colore: Porpora AK39V Grinz  
Vetro: rifle (31)  
Maniglia: A 952 X (Porpora AK39V Grinz )

**WADIRUM/MH1**

Colore base: RAL 6021 Grinz  
2° colore: RAL 6009 Grinz  
Vetro: satinato A (31)  
Maniglia: A 973 X (RAL 6009 Grinz)



**WADIRUM/MH4**

Colore base: Ghisa RP102M  
2° colore: Abete bianco RP14L  
Vetro: decoro GS (67)  
Maniglia: A 971 N



Sahara/HS1 Wadirum/MH1

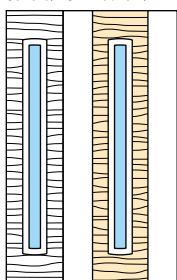

Sahara/HS Wadirum/H1

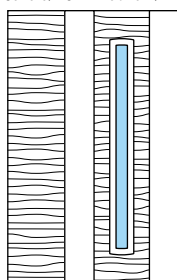

Tablet/YS Wadirum/H4

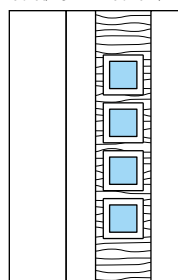

Sahara/HS Wadirum/MH4

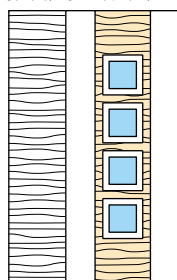

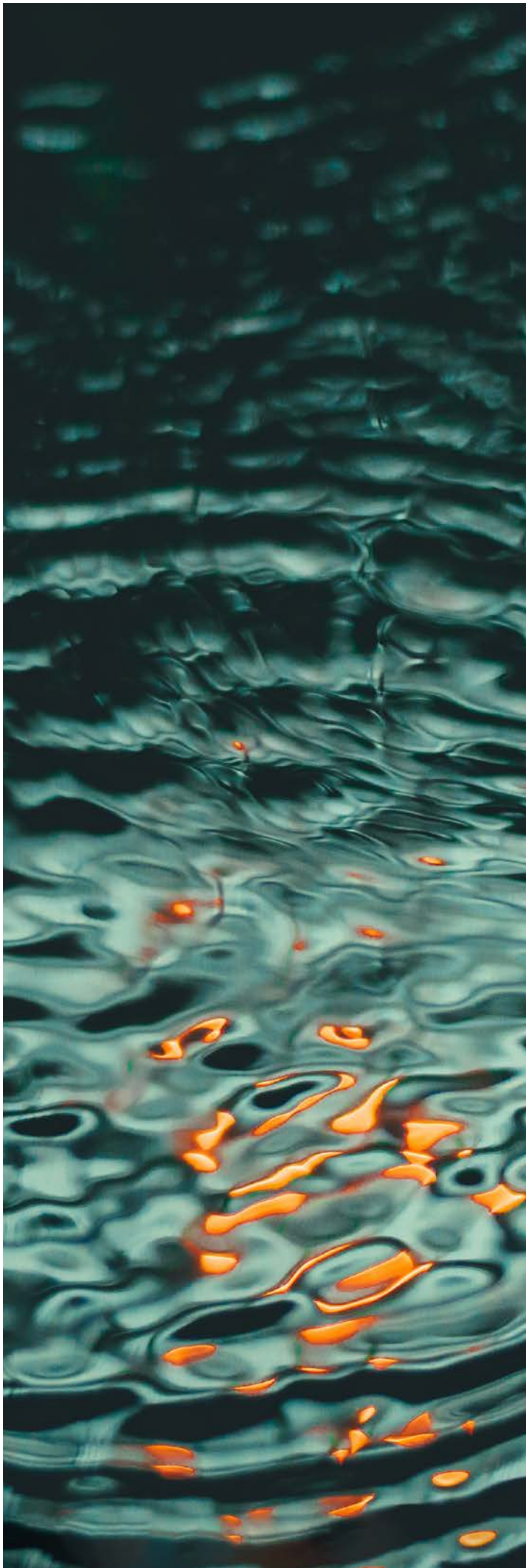

**WADIRUM/MH**

Colore base: RAL 9005 Grinz

2° colore: Ciliegio RP03L

Maniglia: A 418



Sahara/HS1 Wadirum/MH

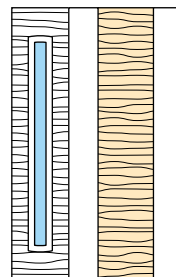

Jolly/HS1 Wadirum/MH

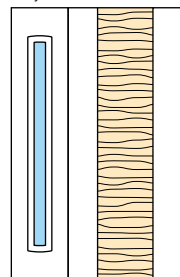

**WADIRUM/H**

Colore: RAL 3005 Grinz  
Maniglia: A 703



**WADIRUM/H**

Colore: Bleu AK15V Grinz  
Maniglia: A 700



INFINITY

STYLE

A FILO

EMOTION

NOVECENTO

INCYSO

VETRI E DECORI

MANIGLIE

PENSILINE

COLORI

SEZ. TECNICA

Sahara/HS Wadirum/H

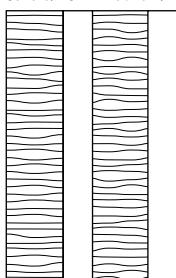

Tablet/YS Wadirum/H

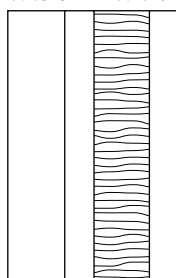



**SAHARA/HS1**

Colore: Ciliegio RP03L  
Vetro: rifle (31)

**GOBI/MH**

Colore base: RAL 9005 Grinz  
2° colore: Ciliegio RP03L  
Maniglia: A 971 C con illuminazione a led



**GOBI/MH**

Colore base: Ghisa RP102M  
2° colore: RAL 9016 Grinz  
Maniglia: A 942



**GOBI/H**

Colore: RAL 3004 Grinz  
Maniglia: A 955 N



Sahara/HS1 Gobi/MH

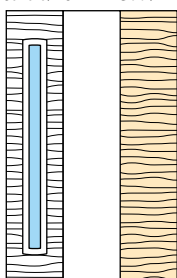

Sahara/HS Gobi/MH

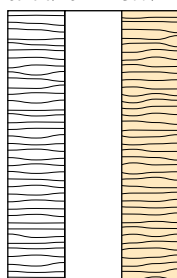

Sahara/HS1 Gobi/H

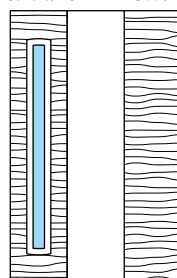

Sahara/HS Gobi/H

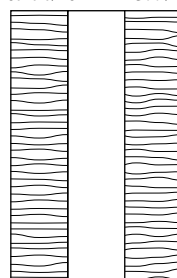

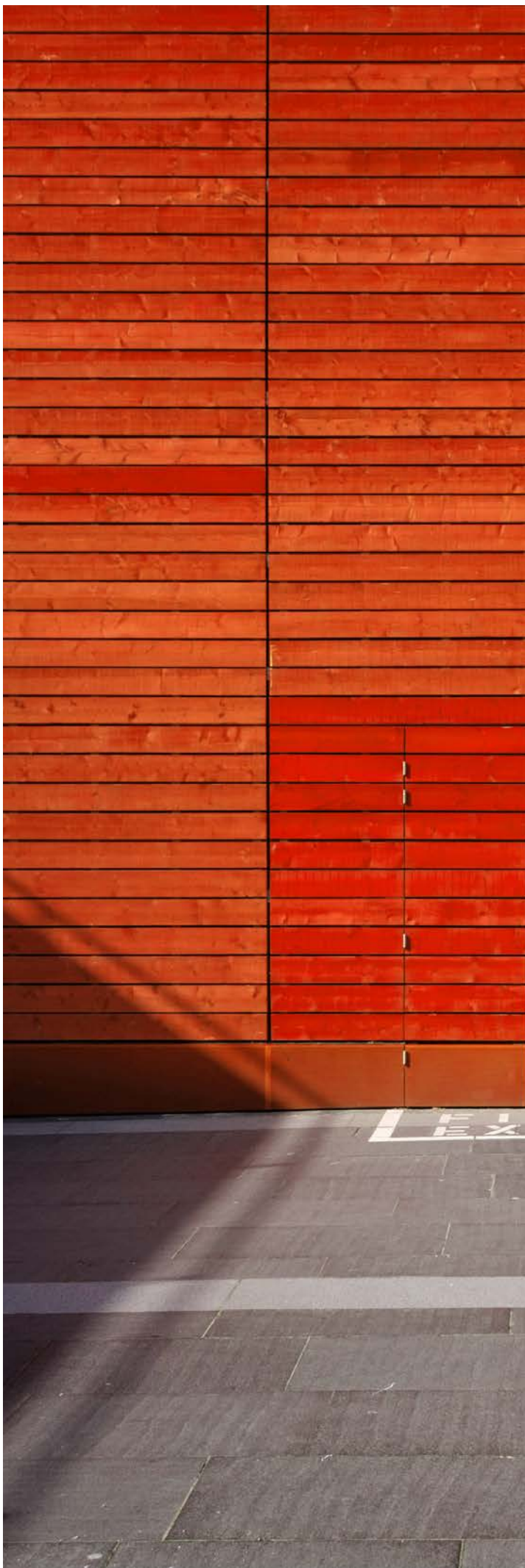

**GOBI/MH4**

Colore base: RAL 9005 lucido  
 2° colore: Orange AK38V Grinz  
 Cornice vetro: RAL 9005 Grinz\* - Vetro: rifile (67)  
 Maniglia: A 945 X (Orange AK38V Grinz)



Tablet/YS Gobi/MH4

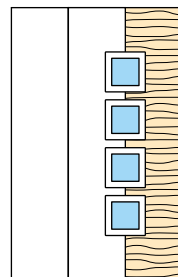

Jolly/HS1 Gobi/H4

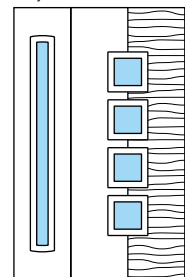

**GOBI/MH1**

Colore base: RAL 7044 Grinz  
2° colore: Bronzo TR03V Grinz  
Vetro: decoro RC (31)  
Maniglia: A 962 R



**GOBI/MH3**

Colore base: RAL 7016 Grinz  
2° colore: RAL 3005 Grinz  
Cornice vetro: RAL 9005 Grinz\* - Vetro: rifle (75)  
Maniglia: A 944 X (RAL 3005 Grinz)



\* Soluzione su richiesta

Sahara/HS1 Gobi/MH1

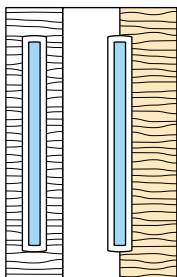

Sahara/HS Gobi/H1

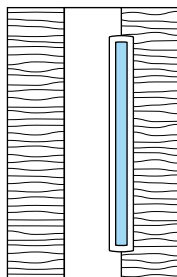

Sahara/HS Gobi/MH3

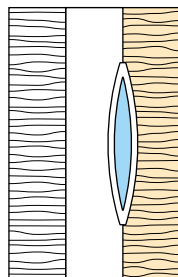

Sahara/HS1 Gobi/H3

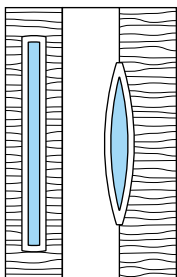

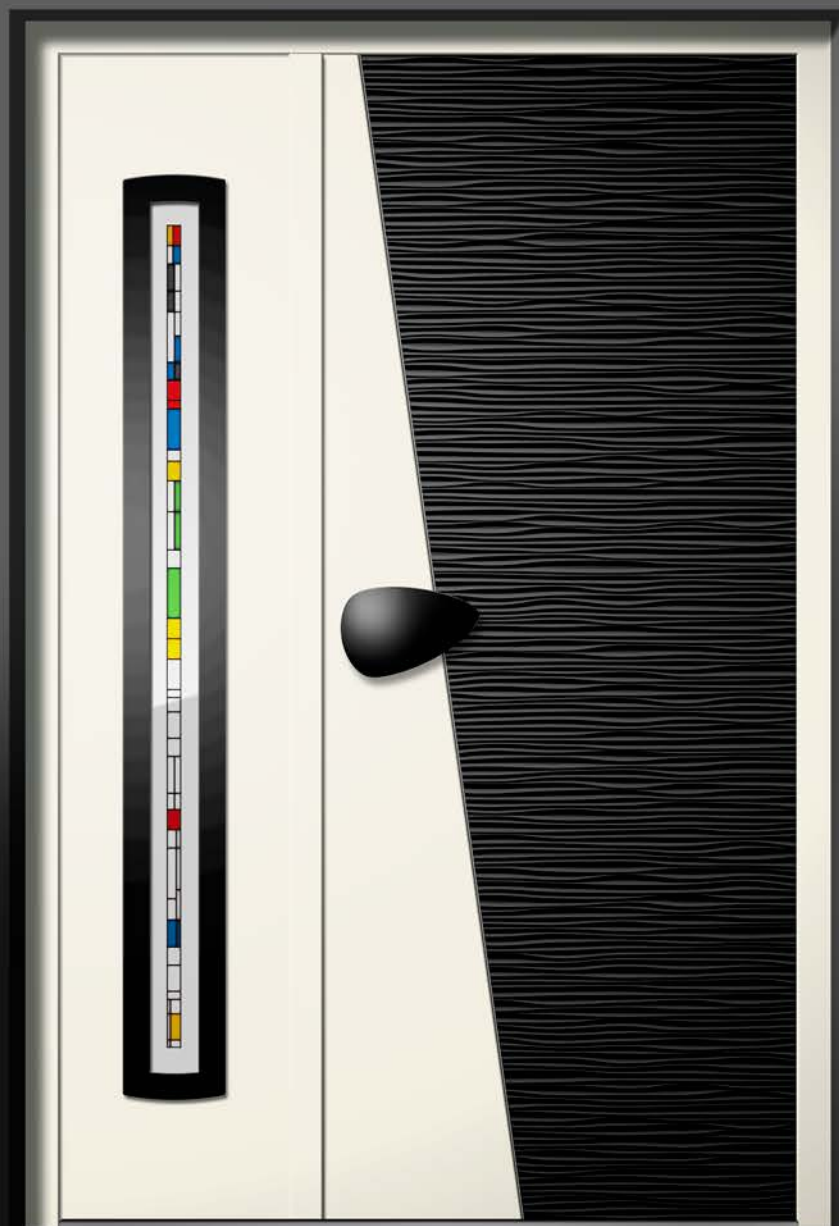

**JOLLY/HS1**

Colore: RAL 9010 Grinz  
Cornice vetro: RAL 9005 Grinz\*  
Vetro: decoro GC (31)

**KALAHARI/MHD**

Colore base: RAL 9010 Grinz  
2° colore: RAL 9005 Grinz  
Maniglia: A 944 N

**KALAHARI/MHD**

Colore base: RAL 7016 Grinz  
2° colore: RAL 7005 Grinz  
Maniglia: A 946 R



**KALAHARI/H**

Colore: Bronzo TR03V Grinz  
Maniglia: A 945



INFINITY

STYLE

A FILO

EMOTION

NOVECENTO

INCYSO

VETRI E DECORI

MANIGLIE

PENSILINE

COLORI

SEZ. TECNICA

\* Soluzione su richiesta

Jolly/HS1 Kalahari/MHD

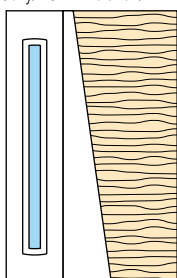

Kalahari/MH Sahara/HS

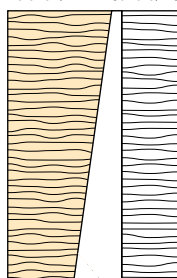

Jolly/HS1 Kalahari/HD

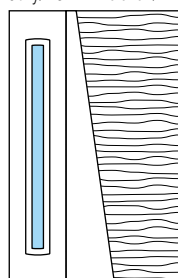

Kalahari/H Tablet/YS

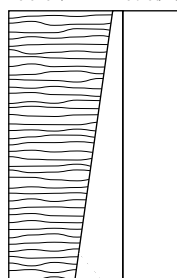



**JOLLY/HS1**

Colore: RAL 9005 lucido  
Vetro: decoro GS (31)

**SONORA/FD**

Colore: RAL 9005 lucido  
Maniglia: A 961 N con illuminazione a led

**SONORA/MFD**

Colore base: RAL 7016 Grinz  
2° colore: RAL 9005 Grinz  
Maniglia: A 703



**SONORA/MFD**

Colore base: RAL 7016 Grinz  
2° colore: Melon AK37V Grinz  
Maniglia: A 703



Sahara/HS1 Sonora/F

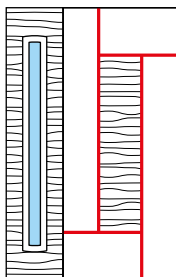

Jolly/HS1 Sonora/FD

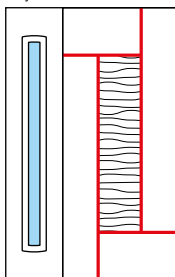

Sahara/HS Sonora/MF

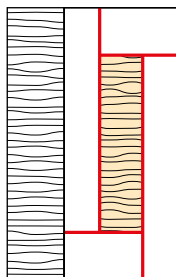

Tablet/YS Sonora/MFD

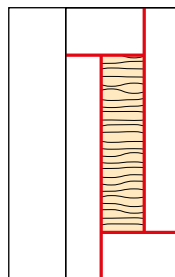

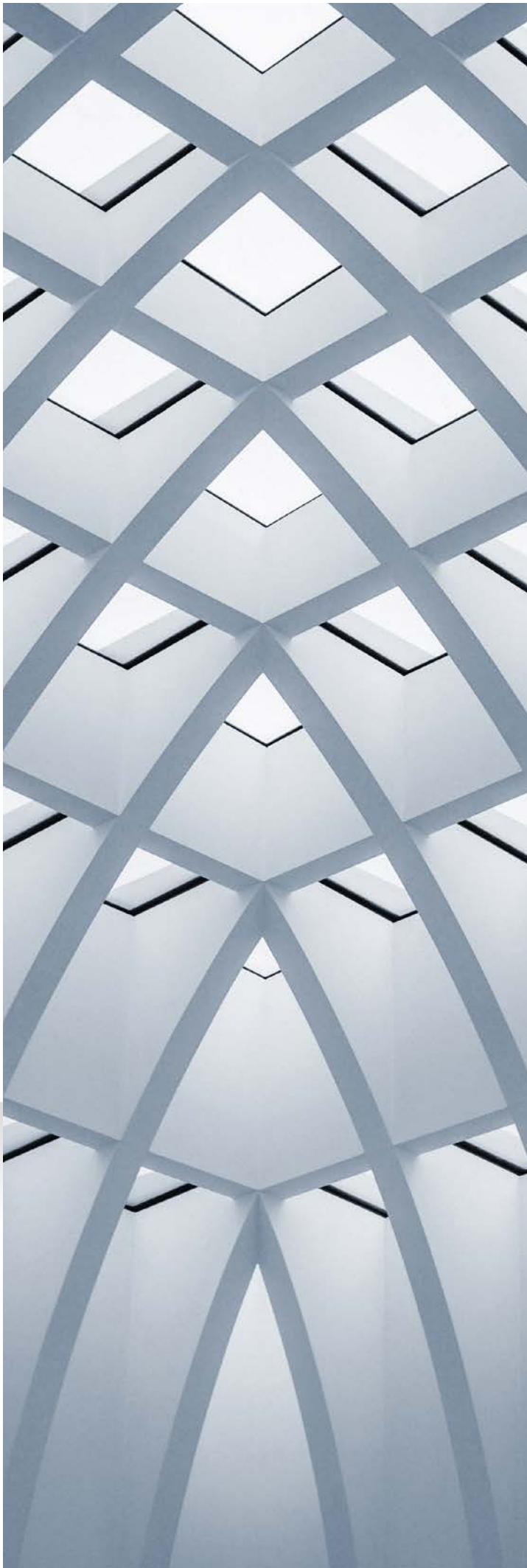

**SONORA/MFD1**

Colore base: RAL 5003 Grinz

2° colore: RAL 9010 Grinz

Vetro: decoro GS (77)

Maniglia: A 703



Sonora/FD1

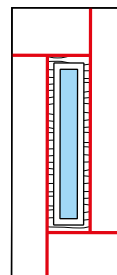

Sonora/F1

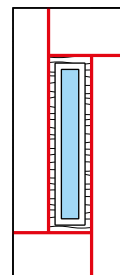

Sonora/MFD1

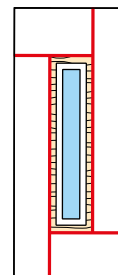

Sonora/MF1

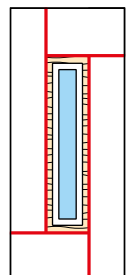



**SONORA/FD3**

Colore base: RAL 7044 Grinz

Inseri: RAL 5003 Grinz\*

Vetro: rifle (75)

Maniglia: A 952 X (RAL 5003 Grinz)



**SONORA/MFD3**

Colore base: RAL 7044 Grinz

2° colore: RAL 5003 Grinz - Insetti: RAL 5003 Grinz\*

Vetro: rifle (75)

Maniglia: A 952 X (RAL 5003 Grinz)



\* Soluzione su richiesta

Sahara/HS1 Sonora/FD3

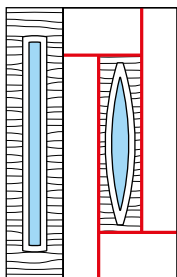

Jolly/HS1 Sonora/F3

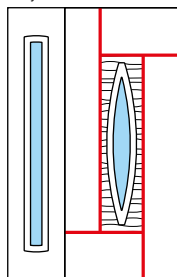

Sahara/HS Sonora/MFD3

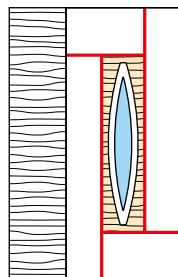

Tablet/YS Sonora/MF3

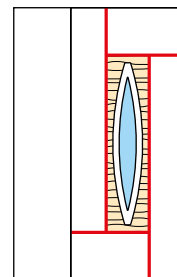

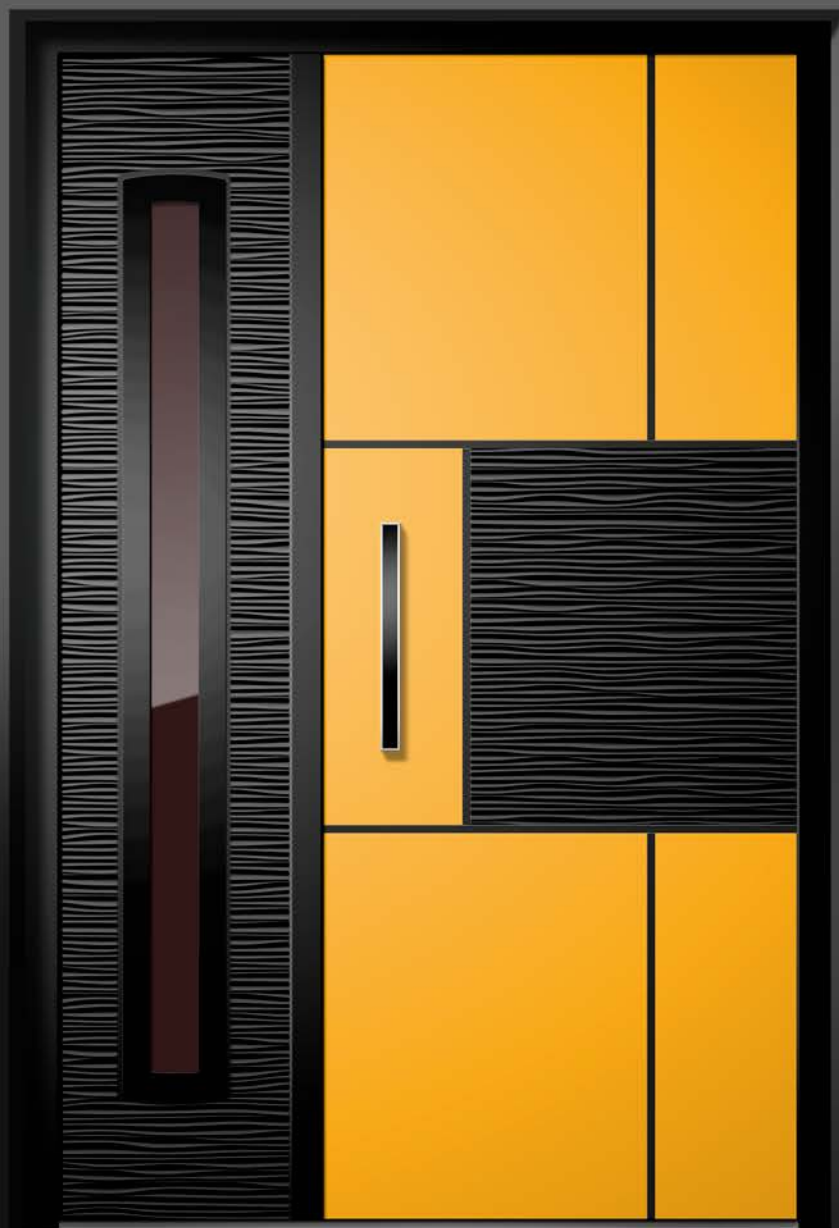

**SAHARA/HS1**

Colore: RAL 9005 Grinz  
Cornice vetro: RAL 9005 Grinz\*  
Vetro: rifle (31)

**MOJAVE/MF**

Colore base: Melon AK37V Grinz  
2° colore: RAL 9005 Grinz  
Inseri: RAL 9005 Grinz\*  
Maniglia: A 951 N

**MOJAVE/MF**

Colore base: Abete bianco RP14L  
2° colore: RAL 6009 Grinz - Insetti: RAL 6009 Grinz\*  
Maniglia: A 971 X (RAL 6009 Grinz)



**MOJAVE/F**

Colore: RAL 9005 Grinz  
Maniglia: A 961 N



\* Soluzione su richiesta

Sahara/HS1 Mojave/MF

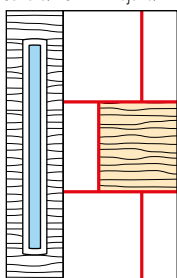

Sahara/HS1 Mojave/F

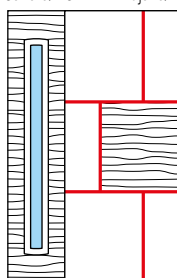

Tablet/YS Mojave/MF

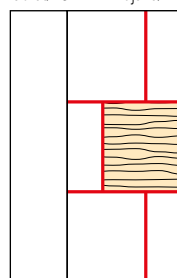

Jolly/HS1 Mojave/F

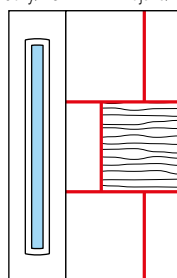



**GIBSON/MHS**

Colore base: Corten RP101M  
2° colore: RAL 9005 Grinz

**GIBSON/MH**

Colore base: Corten RP101M  
2° colore: RAL 9005 Grinz  
Maniglia: A 942 X (Corten V001V Grinz Mix)

**GIBSON/MH**

Colore base: RAL 9005 Lucido  
2° colore: RAL 7038 Grinz  
Maniglia: A 941 R



**GIBSON/H**

Colore: RAL 9005 Grinz  
Maniglia: A 943 N



Gibson/MHS Gibson/MH

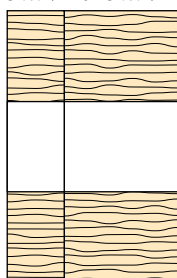

Sahara/HS1 Gibson/MH

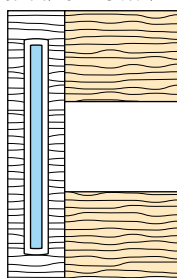

Gibson/HS Gibson/H

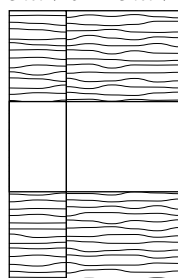

Sahara/HS1 Gibson/H

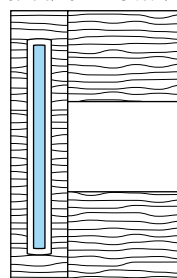



**ADRAR/MHS**

Colore base: RAL 8019 lucido  
2° colore: RAL 9010 Grinz

**ADRAR/MH**

Colore base: RAL 8019 lucido  
2° colore: RAL 9010 Grinz  
Maniglia: A 941

**ADRAR/MH**

Colore base: Avorio AK16V Grinz  
2° colore: RAL 8014 Grinz  
Maniglia: A 942 X (RAL 8014 Grinz)



**ADRAR/H**

Colore: RAL 5003 Lucido  
Maniglia: A 972 X (RAL 5003 Grinz)  
con illuminazione a led



Adrar/MHS Adrar/MH

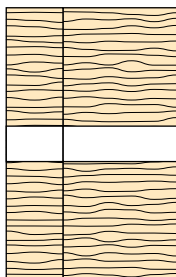

Sahara/HS1 Adrar/MH

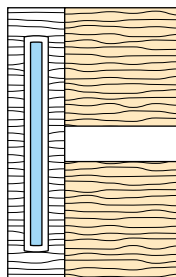

Adrar/HS Adrar/H

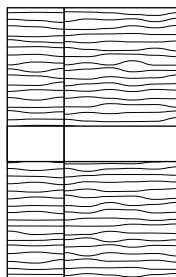

Sahara/HS1 Adrar/H

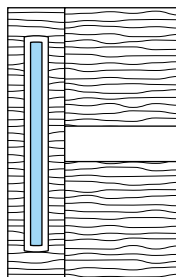

# CARATTERISTICHE TECNICHE

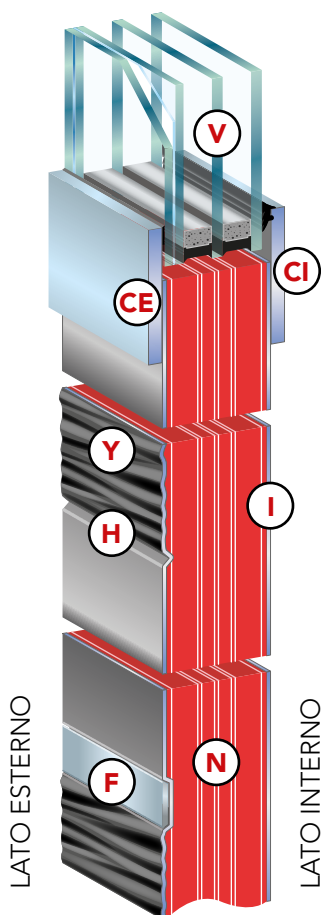

**CE - Cornice lato esterno** realizzata in acciaio inox AISI 316L satinato. Su richiesta, con finitura colore nero Ral 9005 Grinz.

**CI - Cornice lato interno** stesse caratteristiche e possibilità di personalizzazione della cornice sul lato esterno, può essere smontata e rimontata facilmente, per l'installazione e la sostituzione del vetro.

**F - Lavorazione decorativa** di mm 17 x 2 di profondità, ricavata sulla lastra di alluminio, nella quale è incastonato l'inserto in alluminio nella finitura di serie effetto inox. Su richiesta, finitura nei colori della serie Lac ed Exclusive.

**H - Lavorazione decorativa** con bisellatura di mm 6 x 3 di profondità, ricavata sulla lastra di alluminio.

**I - Lato interno liscio** realizzato di serie dello stesso colore del lato esterno (o colore base per i modelli bicolore). Su richiesta, colori diversi e varianti decorative come indicate sotto.

**N - Nucleo** costituito da un mix di materiali particolarmente performanti, disposti in più strati, con ottime proprietà di isolamento termico ed abbattimento acustico. Materiali e prestazioni variano in base alla tipologia e allo spessore del pannello.

**V - Vetro isolante fornito su richiesta** realizzato con doppio o triplo vetro in base allo spessore del pannello. In entrambe le soluzioni, il vetro esterno è stratificato e quello interno temprato, in conformità alle vigenti norme sulla sicurezza. Per consentire il fissaggio della cornice interna, lo spessore del vetro deve essere inferiore di almeno 4 mm rispetto a quello del pannello.

**Y - Lavorazione decorativa Infinity** con sinuose increspature realizzate sulla lastra di alluminio. Per le finiture effetto legno, vedi limitazioni alla pagina successiva.

**LATO ESTERNO**

**Esempio**

**LATO**

**INTERNO (di serie)**

**Liscio**  
Monocolore

**VARIANTI**

**DECORATIVE LATO INTERNO (su richiesta)**

**Light**  
Monocolore, solo lavorazione **H\***

**Double**  
Uguale al lato esterno



\* La lavorazione **H** riproduce sempre lo stesso disegno del modello esterno. Variante non disponibile per i modelli Sahara e Tenerè.



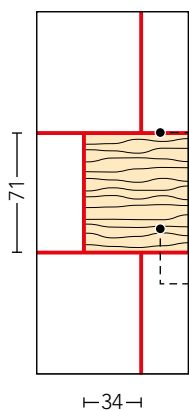

### DISEGNI E SIMBOLI

I disegni dei pannelli sono proporzionati alle dimensioni di cm 90 x 215 per l'anta principale e cm 45 x 215 per la mezza anta. Le quote indicate nei disegni (esprese in centimetri) indicano l'ingombro dell'area decorativa del modello. Con il termine area decorativa, si intende la parte lavorata del pannello che ne caratterizza il modello. L'area decorativa ha misure fisse e la sua posizione, rispetto al perimetro del pannello, può essere centrata o vincolata ad uno o più lati, quindi ad un angolo. I punti di vincololo sono indicati nei disegni con questo simbolo  (vedi figure in basso).

**Inserti.** I modelli con gli inserti sono indicati da linee rosse nei rispettivi disegni.

**Modelli bicolore.** I modelli realizzabili in finiture bicolore sono indicati nei rispettivi disegni con la parte evidenziata in colore giallo. Essa rappresenta la porzione del pannello che verrà realizzata nel 2° colore indicato nel modulo ordine. Tutto il resto del pannello, compreso il suo lato interno e le eventuali cornici del vetro, sarà realizzato di serie nel colore base.

### DIMENSIONI E SPESSORI

I pannelli sono disponibili nelle dimensioni e negli spessori indicati nell'apposito capitolo tecnico. Nella scelta del modello, valutare che l'ingombro dell'area decorativa non interferisca con il profilo perimetrale in cui è alloggiato il pannello. Il margine consigliato per garantire un buon risultato estetico, è di almeno un centimetro lungo tutto il perimetro del pannello, al netto della presa dello stesso all'interno del profilo.

**Taglio a misura.** Il taglio a misura del pannello viene eseguito su richiesta, rispettando i vincoli dell'area decorativa del modello come sopra descritti ed indicati nelle figure in basso. Per esigenze particolari, ma nei limiti consentiti dall'area decorativa e dalle dimensioni richieste, il taglio a misura può essere effettuato decentrato. L'eventuale fattibilità va richiesta tramite l'invio di un disegno quotato del modello.

### LIMITAZIONI

**Spessori.** I modelli di questa collezione nella tipologia Kover **KR 7**, per rivestimento di porte blindate, sono realizzabili fino allo spessore minimo di 6 millimetri.

**Verso delle venature.** Tutti i colori effetto legno, avranno le venature disposte in senso verticale rispetto al pannello.

**Pannelli nei colori legno fuori cartella.** Saranno realizzati su richiesta presso impianti esterni. Per esigenze produttive, i pannelli con queste finiture avranno dei fori lungo i bordi verticali che ne riducono la misura utile in larghezza di circa 4 cm.

**Lavorazione decorativa Infinity (Y).** La parte di pannello con questa lavorazione non è realizzabile nei colori della serie Skin (pellicolati) e colori legno fuori cartella (foto a fianco).

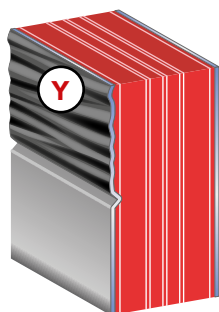

Fig. 1  
area decorativa  
centrata

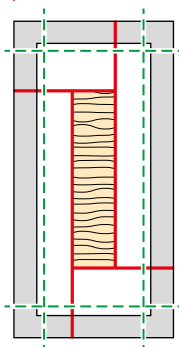

Fig. 2  
area decorativa  
vincolata ai lati

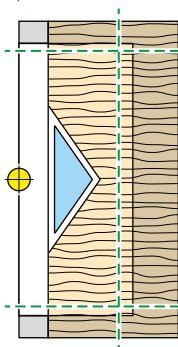
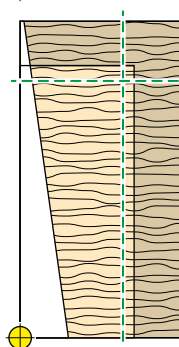
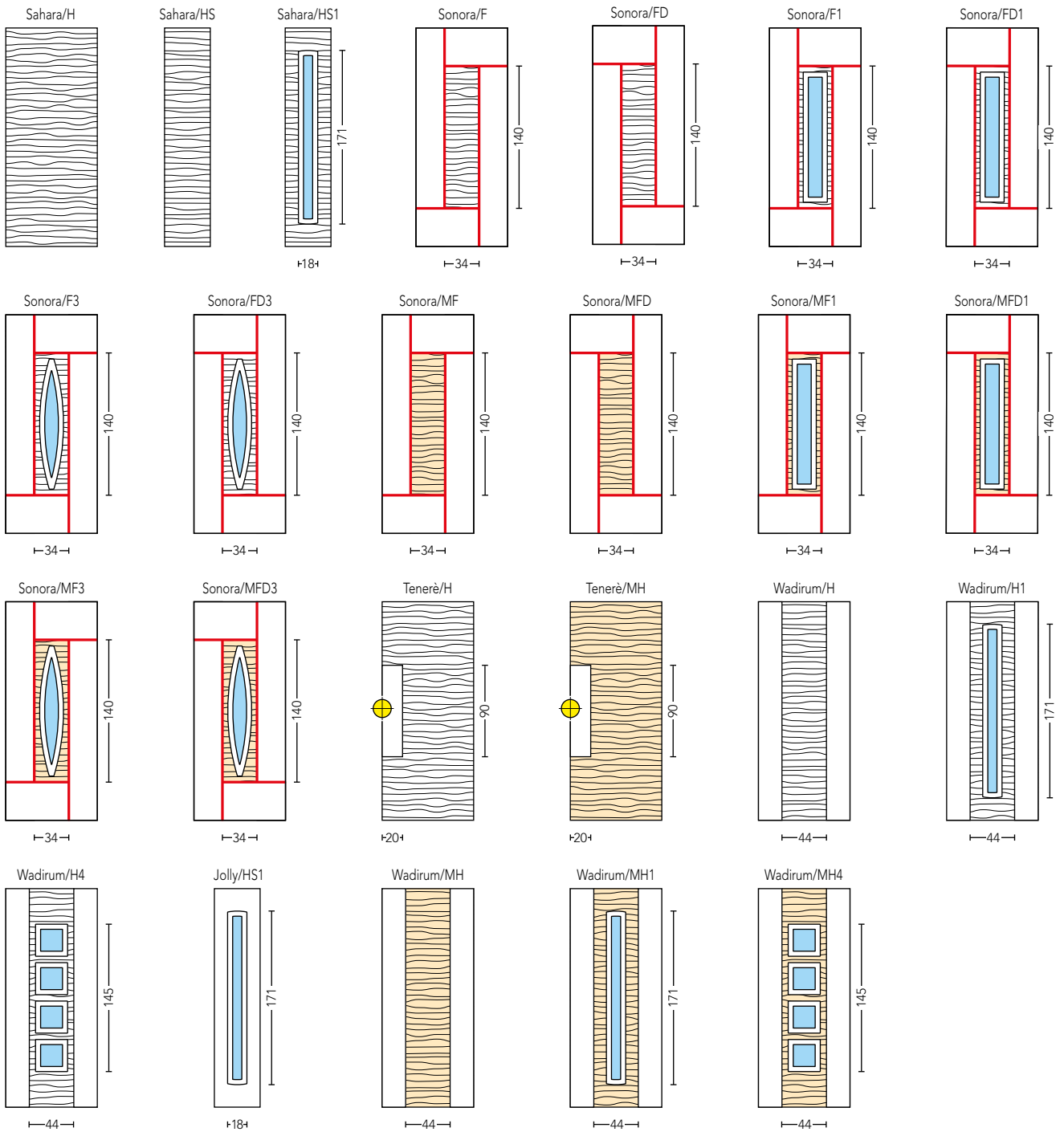

Fig. 3  
area decorativa  
vincolata agli angoli



# DISEGNI





134a

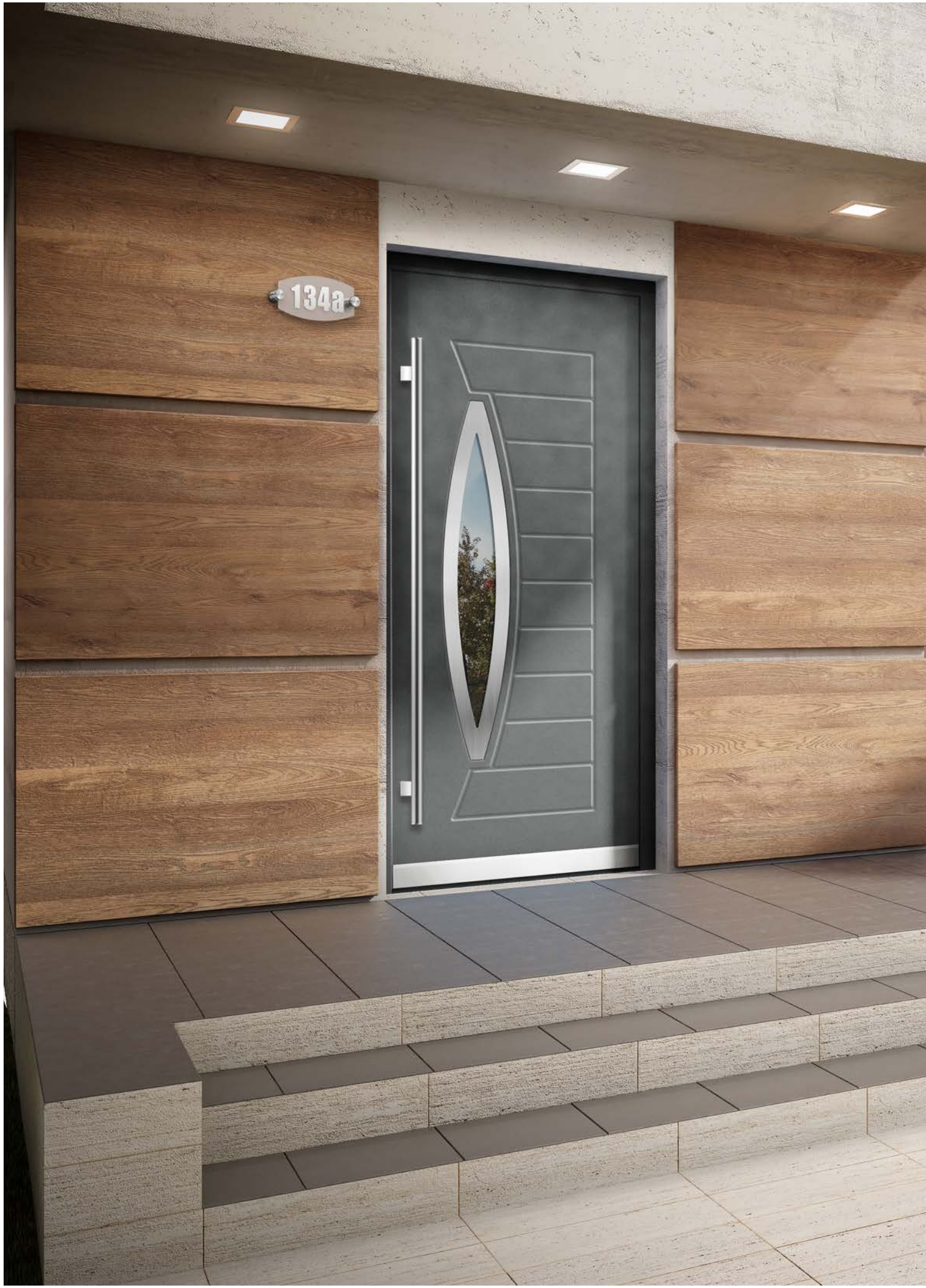



Più della tendenza  
è l'essere unici!

# STYLE

La collezione Style è eleganza, gusto e innovazione. Linee geometriche e materiali moderni si plasmano e si contaminano per esaltare un ingresso dal design minimale e di tendenza, pensato non solo per essere notato ma soprattutto ricordato.

INFINITY

STYLE

A FILO

EMOTION

NOVECENTO

INCYSO

VETRI E DECORI

MANIGLIE

PENSILINE

COLORI

SEZ. TECNICA

# INDICE

**CASSIOPEA/Z**  
Pag. 71



**CASSIOPEA/ZX**  
Pag. 71



**CASSIOPEA/ZX1**  
Pag. 70



**ECHO/Z**  
Pag. 69



**ECHO/ZX**  
Pag. 69



**ECHO/Z1**  
Pag. 68



**FENDY/Z**  
Pag. 77



**FENDY/ZX**  
Pag. 77



**FENDY/Z1**  
Pag. 76



**HELLY/Z**  
Pag. 67



**HELLY/ZX**  
Pag. 67



**HELLY/Z1**  
Pag. 66



**JOLLY/ZM**  
Pag. 89



**JOLLY/ZXM**  
Pag. 89



**JOLLY/ZM1**  
Pag. 88



**KANOA/Z**  
Pag. 65



**KANOA/ZX**  
Pag. 65



**KANOA/Z1**  
Pag. 64



**KUBO/Z**  
Pag. 87



**KUBO/ZX**  
Pag. 87



**KUBO/Z1**  
Pag. 86



**MIRROR/Z**  
Pag. 79



**MIRROR/ZX**  
Pag. 79



**MIRROR/Z1**  
Pag. 78



**MIRROR/ZM**  
Pag. 81



**MIRROR/ZXM**  
Pag. 81



**MIRROR/ZM1**  
Pag. 80



**MOON/Z**  
Pag. 73



**MOON/ZX**  
Pag. 73



**MOON/Z1**  
Pag. 72



**OBLÒ/Z**  
Pag. 75



**OBLÒ/ZX**  
Pag. 75



**OBLÒ/Z1**  
Pag. 74



**OVER/Z**  
Pag. 83



**OVER/ZX**  
Pag. 83



**OVER/Z1**  
Pag. 82



# INDICE

**OVER/ZM**  
Pag. 83



**ROTARY/Z**  
Pag. 57



**ROTARY/ZX**  
Pag. 57



**ROTARY/Z4**  
Pag. 56



**SPIN/Z**  
Pag. 63



**SPIN/ZX**  
Pag. 63



**SPIN/Z2**  
Pag. 62



**SUNRAY/Z**  
Pag. 59



**SUNRAY/ZX**  
Pag. 59



**SUNRAY/Z4**  
Pag. 58



**TRIANGOLO/Z**  
Pag. 85



**TRIANGOLO/ZX**  
Pag. 85



**TRIANGOLO/Z1**  
Pag. 84



**VELE/Z**  
Pag. 61



**VELE/ZX**  
Pag. 61



**VELE/Z2**  
Pag. 60







SEZ. TECNICA

COLORI

PENSILINE

MANIGLIE

VETRI E DECORI

INCISO

NOVECENTO

EMOTION

A FILO

STYLE

INFINITY



**MIRROR/ZS1**

Colore: RAL 8019 Grinz  
Vetro: decoro GS (77)

**ROTARY/Z4**

Colore: RAL 8019 Grinz  
Vetro: decoro GS (70)  
Maniglia: A 680

**ROTARY/ZX**

Colore: Corten RP101M  
Maniglia: A 691



**ROTARY/Z**

Colore: RAL 7030 Grinz  
Maniglia: A 961 N



INFINITY

STYLE

A FILO

EMOTION

NOVECENTO

INCYSO

VETRI E DECORI

MANIGLIE

PENSILINE

COLORI

SEZ. TECNICA

Mirror/ZS1 Rotary/Z4

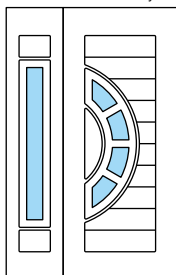

Jolly/ZXS Rotary/ZX

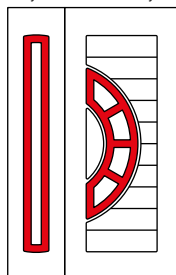

Over/ZS Rotary/Z

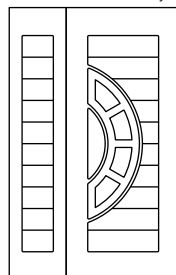

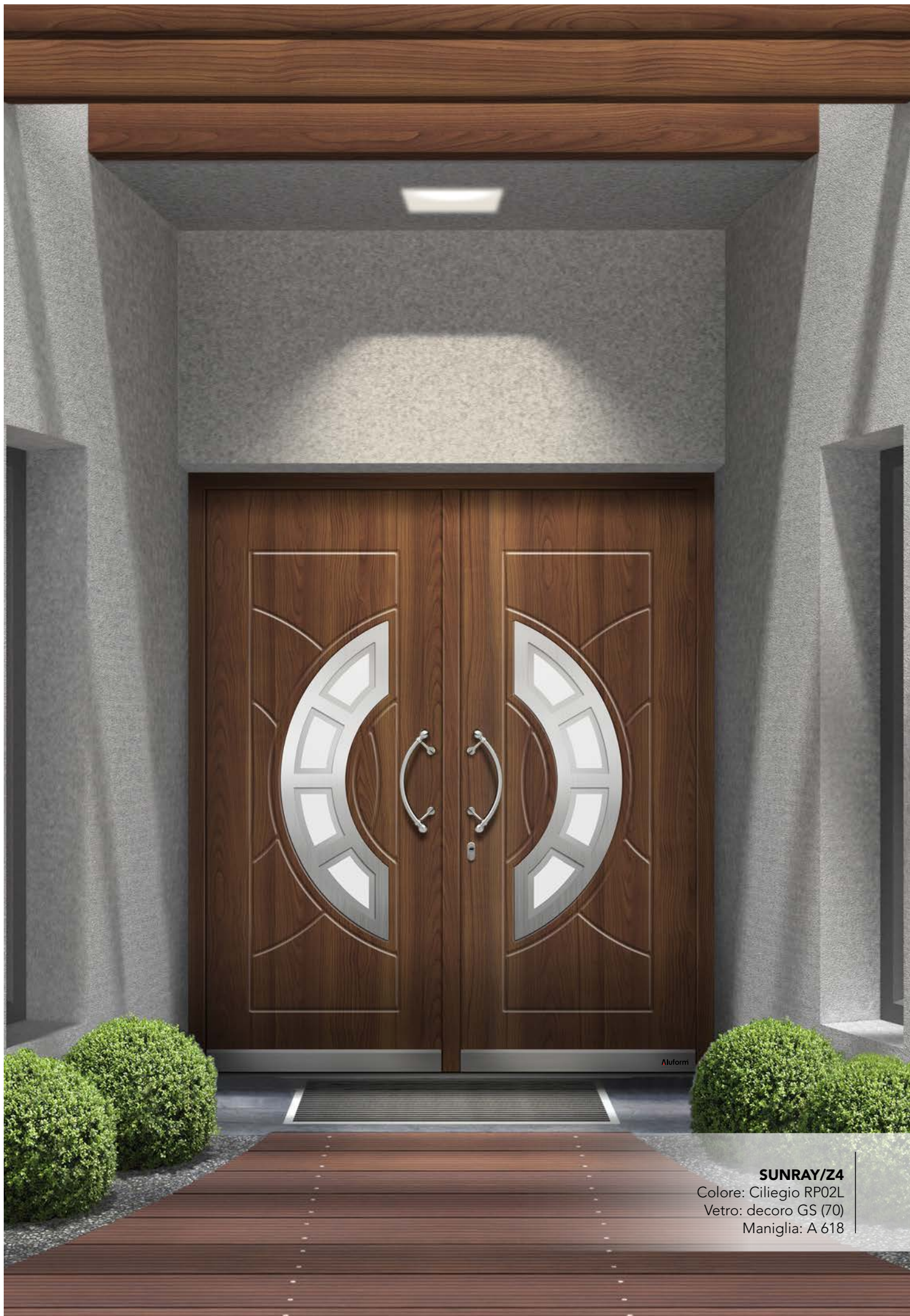

**SUNRAY/Z4**  
Colore: Ciliegio RP02L  
Vetro: decoro GS (70)  
Maniglia: A 618

**SUNRAY/ZX**

Colore: Antracite P016V Grinz  
Maniglia: A 680



**SUNRAY/Z**

Colore: RAL 7005 Grinz  
Maniglia: A 622



INFINITY

STYLE

A FILO

EMOTION

NOVECENTO

INCYSO

VETRI E DECORI

MANIGLIE

PENSILINE

COLORI

SEZ. TECNICA

Jolly/ZS1 Sunray/Z4

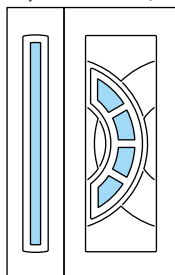

Jolly/ZXS Sunray/ZX

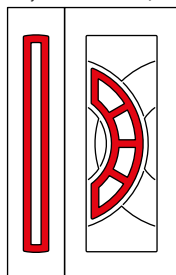

Jolly/ZS Sunray/Z

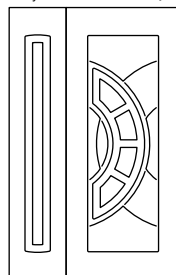



**JOLLY/ZS1**

Colore: RAL 9016 Grinz  
Cornici vetro: RAL 9005 Grinz\*  
Vetro: rifle (31)

**VELE/Z2**

Colore: RAL 9016 Grinz  
Cornici vetro: RAL 9005 Grinz\*  
Vetro: rifle (57-58)  
Maniglia: A 951 N (2 pezzi)

**VELE/ZX**

Colore: RAL 7038 Grinz  
Maniglia: A 619 (3 pezzi)



**VELE/Z**

Colore: RAL 6009 Grinz  
Maniglia: A 619 (3 pezzi)



\* Soluzione su richiesta

Jolly/ZS1      Vele/Z2

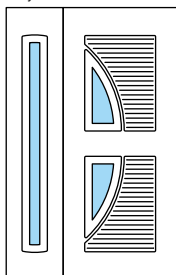

Jolly/ZXS      Vele/ZX

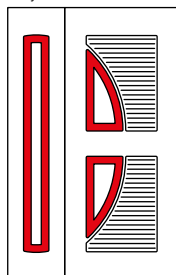

Jolly/ZS      Vele/Z

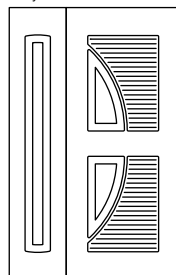

**STYLE**  
COLLECTION



**MIRROR/ZS1**

Colore: RAL 3005 Grinz  
Vetro: decoro GS (77)

**SPIN/Z2**

Colore: RAL 3005 Grinz  
Vetro: decoro GS (57-58)  
Maniglia: A 622



**SPIN/ZX**

Colore: RAL 7006 Grinz  
Maniglia: A 953



**SPIN/Z**

Colore: RAL 7044 Grinz  
Maniglia: A 961 N



INFINITY

STYLE

A FILO

EMOTION

NOVECENTO

INCYSO

VETRI E DECORI

MANIGLIE

PENSILINE

COLORI

SEZ. TECNICA

Mirror/ZS1 Spin/Z2

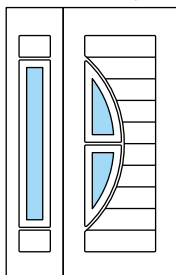

Jolly/ZXS Spin/ZX

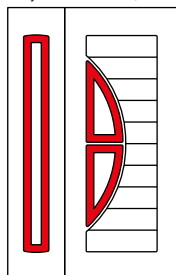

Over/ZS Spin/Z

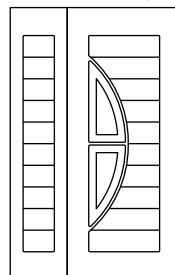

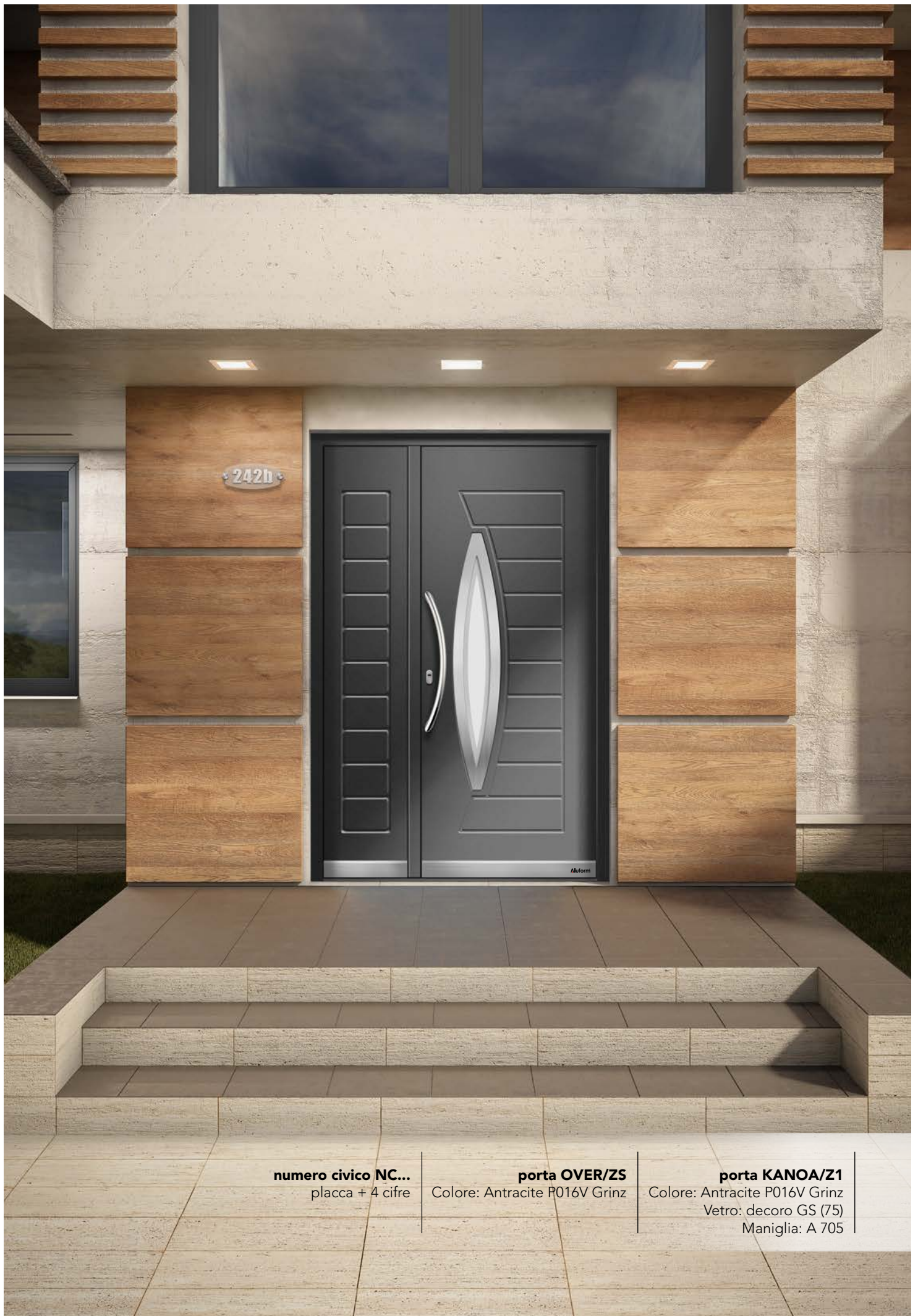

**numero civico NC...**  
placca + 4 cifre

**porta OVER/ZS**  
Colore: Antracite P016V Grinz

**porta KANOA/Z1**  
Colore: Antracite P016V Grinz  
Vetro: decoro GS (75)  
Maniglia: A 705

**KANOA/ZX**

Colore: Ghisa RP102M  
Maniglia: A 624



**KANOA/Z**

Colore: Rovere grigio RP10L  
Maniglia: A 702



INFINITY

STYLE

A FILO

EMOTION

NOVECENTO

INCYSO

VETRI E DECORI

MANIGLIE

PENSILINE

COLORI

SEZ. TECNICA

Mirror/ZS1 Kanoa/Z1

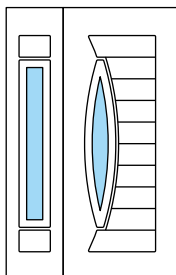

Jolly/ZXS Kanoa/ZX

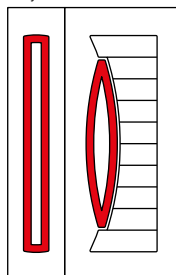

Over/ZS Kanoa/Z

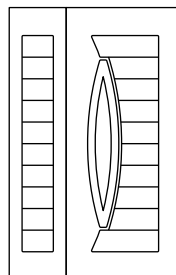



**HELLY/Z1**

Colore: Corten RP101M

Vetro: decoro GL (60)

Maniglia: A 700



Jolly/ZS1

Helly/Z1

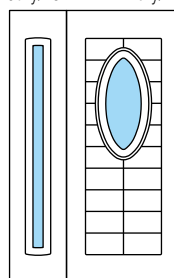

**HELLY/ZX**

Colore: RAL 7030 Grinz  
Maniglia: A 683



**HELLY/Z**

Colore: Beige AK12V Grinz Mix  
Maniglia: A 507

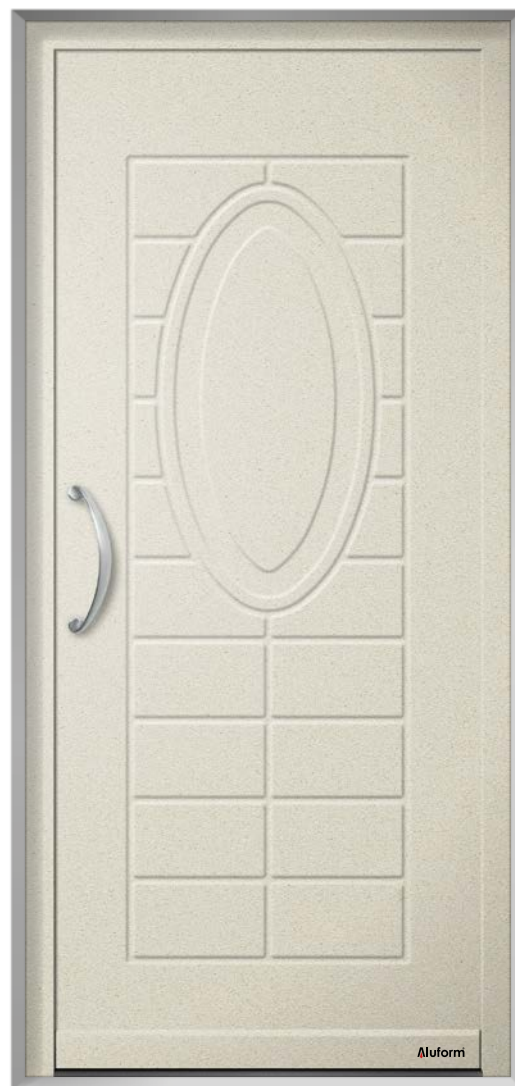

INFINITY

STYLE

A FILO

EMOTION

NOVECENTO

INCYSO

VETRI E DECORI

MANIGLIE

PENSILINE

COLORI

SEZ. TECNICA

Jolly/ZXS Helly/ZX

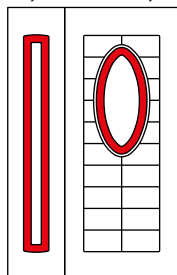

Over/ZS Helly/Z

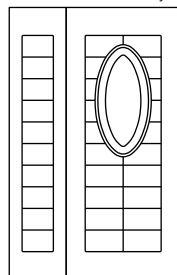



Aluform

**numero civico NC...**  
placca + 1 cifra

**porta ECHO/Z1**  
Colore: Melon AK37V Grinz  
Cornice vetro: RAL 9005 Grinz\*  
Vetro: rifle (60)  
Maniglia: A 961 N

**ECHO/ZX**

Colore: Ghisa RP102M  
Maniglia: A 507



**ECHO/Z**

Colore: RAL 3005 Grinz  
Maniglia: A 683



INFINITY

STYLE

A FILO

EMOTION

NOVECENTO

INCYSO

VETRI E DECORI

MANIGLIE

PENSILINE

COLORI

SEZ. TECNICA

\* Soluzione su richiesta

Jolly/ZS1      Echo/Z1

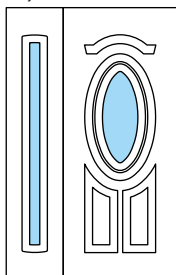

Jolly/ZXS      Echo/ZX

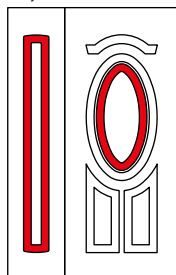

Jolly/ZS      Echo/Z

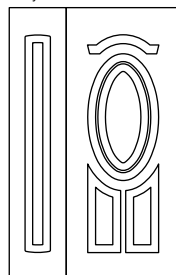

**STYLE**  
COLLECTION



**JOLLY/ZS1**

Colore: RAL 7038 Grinz  
Cornice vetro: RAL 9005 Grinz\*  
Vetro: rifle (31)

**CASSIOPEA/ZX1**

Colore: RAL 7038 Grinz  
Cornice vetro e inserti: RAL 9005 Grinz\*  
Vetro: rifle (53)  
Maniglia: A 951 N

**JOLLY/ZS1**

Colore: RAL 7038 Grinz  
Cornice vetro: RAL 9005 Grinz\*  
Vetro: rifle (31)



**CASSIOPEA/ZX**

Colore: Verde P7100 Mix  
Maniglia: A 703



**CASSIOPEA/Z**

Colore: Salvia AK11V Grinz Mix  
Maniglia: A 570



\* Soluzione su richiesta

Jolly/ZS1 Cassiopea/ZX1

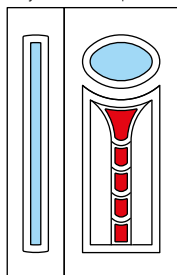

Jolly/ZXS Cassiopea/ZX

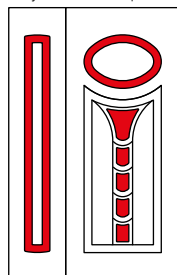

Jolly/ZS Cassiopea/Z

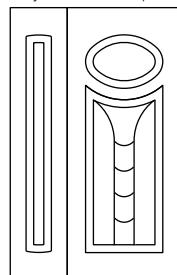

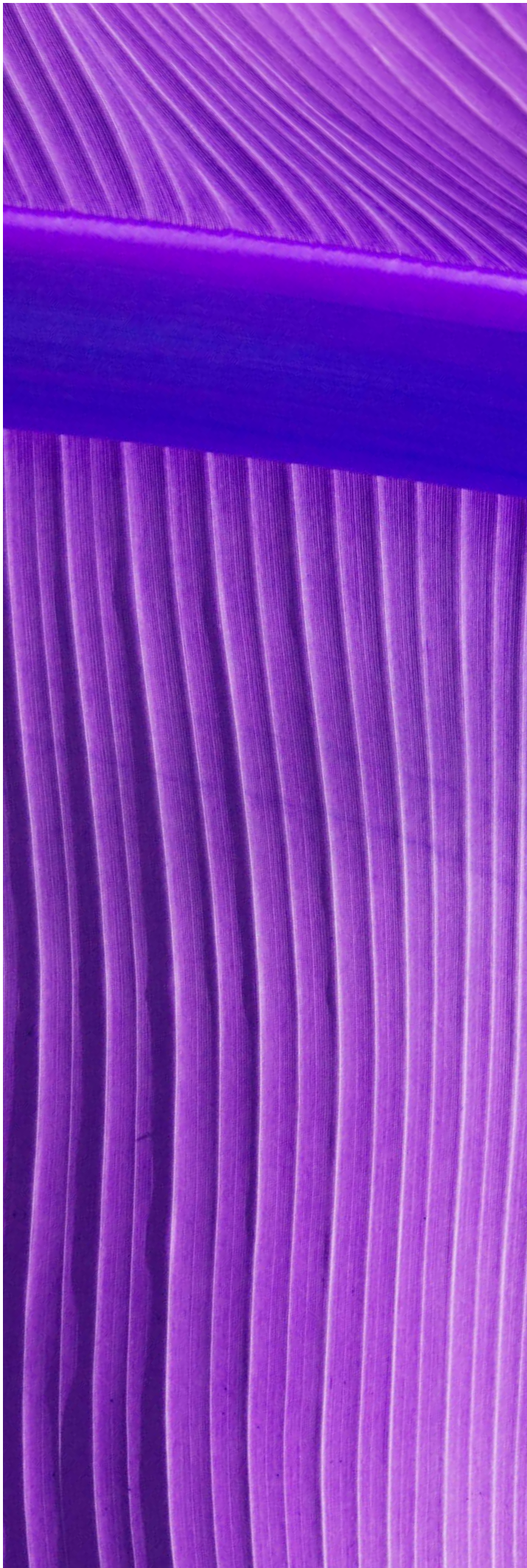

**MOON/Z1**

Colore: RAL 5003 Grinz

Vetro: decoro GS (53)

Maniglia: A 700



Jolly/ZS1

Moon/Z1

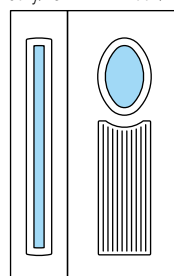

**MOON/ZX**

Colore: Porpora AK39V Grinz  
Maniglia: A 693



**MOON/Z**

Colore: RAL 9006 Grinz  
Maniglia: A 691



INFINITY

STYLE

A FILO

EMOTION

NOVECENTO

INCYSO

VETRI E DECORI

MANIGLIE

PENSILINE

COLORI

SEZ. TECNICA

Jolly/ZXS Moon/ZX

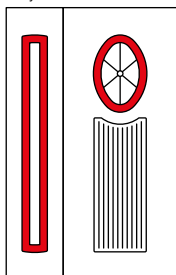

Jolly/ZS Moon/Z

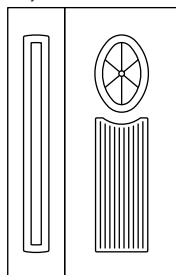



**OBLÒ/Z1**

Colore: Melon AK37V Grinz

Vetro: decoro GS (51)

Maniglia: A 944



Jolly/ZS1

Oblò/Z1

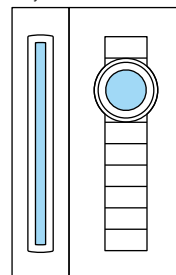

**OBLÒ/ZX**

Colore: RAL 5014 Grinz  
Maniglia: A 951



**OBLÒ/Z**

Colore: RAL 7035 Grinz  
Maniglia: A 685



INFINITY

STYLE

A FILO

EMOTION

NOVECENTO

INCYSO

VETRI E DECORI

MANIGLIE

PENSILINE

COLORI

SEZ. TECNICA

Mirror/ZXS    Oblò/ZX

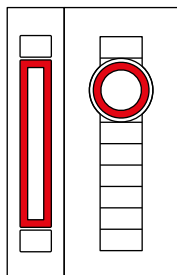

Over/ZS    Oblò/Z

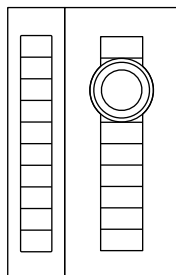



Aluformi

**FENDY/Z1**

Colore: RAL 5010 Grinz

Vetro: satinato A (76)

Maniglia: A 705

**FENDY/ZX**

Colore: Cemento RP103M  
Inserto: RAL 9005 Grinz\*  
Maniglia: A 971 N

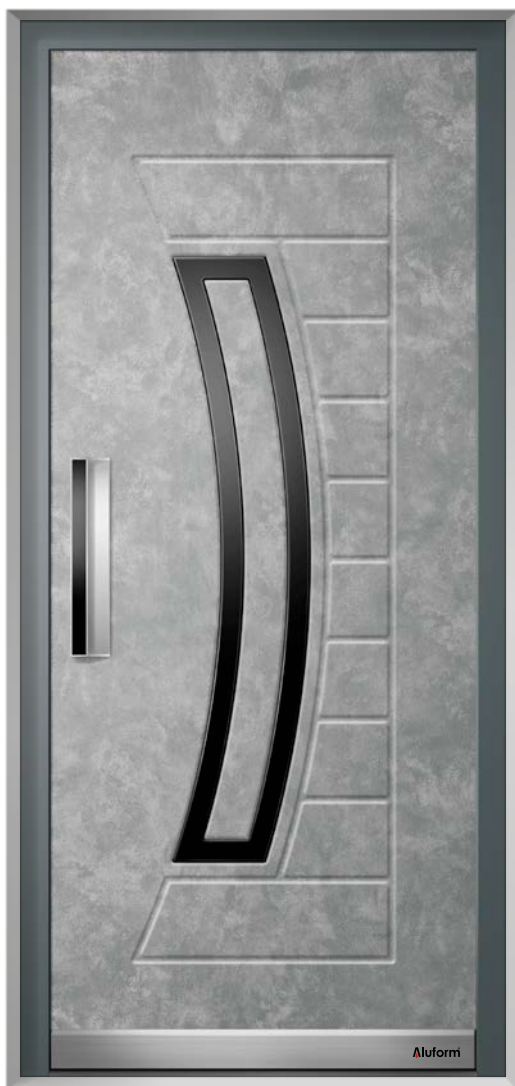

**FENDY/Z**

Colore: Porpora AK39V Grinz  
Maniglia: A 700



INFINITY

STYLE

A FILO

EMOTION

NOVECENTO

INCYSO

VETRI E DECORI

MANIGLIE

PENSILINE

COLORI

SEZ. TECNICA

\* Soluzione su richiesta

Mirror/ZS1 Fendy/Z1

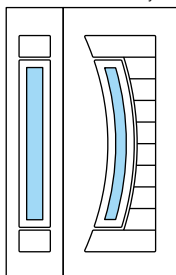

Over/ZS Fendy/ZX

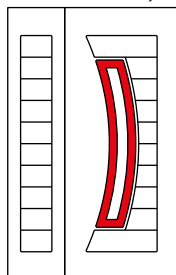

Jolly/ZS Fendy/Z

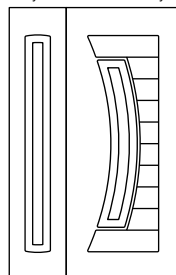



**MIRROR/ZS1**

Colore: Antracite P016V Grinz  
Vetro: decoro GS (77)

**MIRROR/Z1**

Colore: Antracite P016V Grinz  
Vetro: decoro GS (77)  
Maniglia: A 624



**MIRROR/ZX**

Colore: Ghisa RP102M  
Maniglia: A 961



**MIRROR/Z**

Colore: RAL 7004 Grinz  
Maniglia: A 687



INFINITY

STYLE

A FILO

EMOTION

NOVECENTO

INCYSO

VETRI E DECORI

MANIGLIE

PENSILINE

COLORI

SEZ. TECNICA

Mirror/ZS1    Mirror/Z1

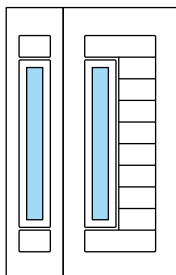

Mirror/ZXS    Mirror/ZX

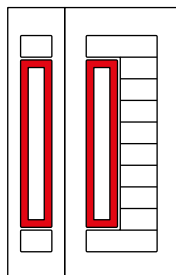

Mirror/ZS    Mirror/Z

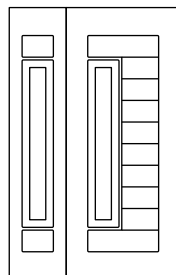

Over/ZS    Mirror/Z

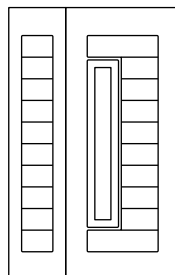



**MIRROR/ZM1**

Colore: Orange AK38V Grinz

Vetro: decoro BL (77)

Maniglia: A 692



Mirror/ZS1    Mirror/ZM1

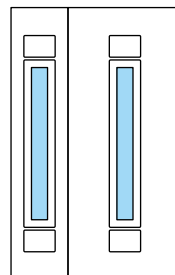

**MIRROR/ZXM**

Colore: Avorio AK16V Grinz  
Maniglia: A 971



**MIRROR/ZM**

Colore: RAL 9010 Grinz  
Maniglia: A 702



INFINITY

STYLE

A FILO

EMOTION

NOVECENTO

INCYSO

VETRI E DECORI

MANIGLIE

PENSILINE

COLORI

SEZ. TECNICA

Mirror/ZXS    Mirror/ZXM

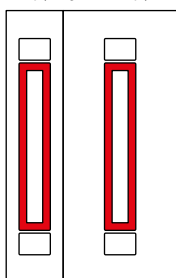

Mirror/ZS    Mirror/ZM

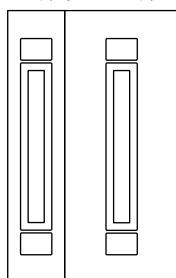



**OVER/ZS**  
Colore: RAL 8019 Grinz

**OVER/Z1**  
Colore: RAL 8019 Grinz  
Vetro: decoro GS (31)  
Maniglia: A 951

**OVER/ZX**

Colore: Ciliegio RP03L  
Maniglia: A 953



**OVER/Z**

Colore: Corten AK10V Grinz Mix  
Maniglia: A 955



INFINITY

STYLE

A FILO

EMOTION

NOVECENTO

INCYSO

VETRI E DECORI

MANIGLIE

PENSILINE

COLORI

SEZ. TECNICA

Jolly/ZS1      Over/Z1

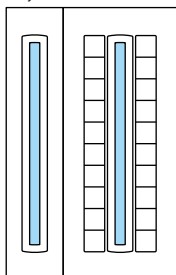

Jolly/ZXS      Over/ZX

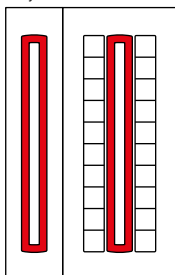

Over/ZS      Over/Z

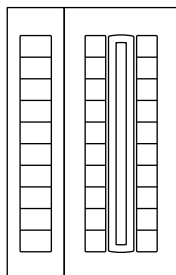

Over/ZM

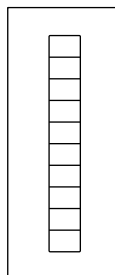



**numero civico NC...**  
placca + 3 cifre

**porta TRIANGOLO/Z1**  
Colore: RAL 6021 Grinz  
Vetro: decoro GL (72)  
Maniglia: A 622

**pensilina TRENDY Mod. TR-05**  
Colore struttura: RAL 9010 Grinz  
Colore capriata: RAL 6021 Grinz  
Copertura: Trasparente

**vela Mod. VL-01**  
Colore struttura: RAL 9010 Grinz  
Colore mensole: RAL 6021 Grinz  
Pannello: Trasparente

**TRIANGOLO/ZX**

Colore: Abete bianco RP14L  
Maniglia: A 682



**TRIANGOLO/Z**

Colore: RAL 6009 Grinz  
Maniglia: A 971



INFINITY

STYLE

A FILO

EMOTION

NOVECENTO

INCYSO

VETRI E DECORI

MANIGLIE

PENSILINE

COLORI

SEZ. TECNICA

Mirror/ZS1 Triangolo/Z1

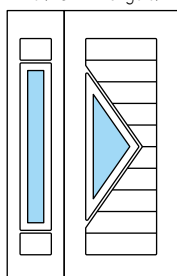

Jolly/ZXS Triangolo/ZX

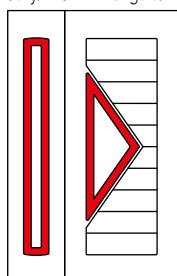

Over/ZS Triangolo/Z

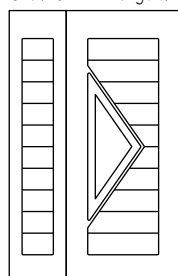



**KUBO/Z1**

Colore: Porpora AK39V Grinz

Vetro: decoro GS (67)

Maniglia: A 518



Jolly/ZS1

Kubo/Z1

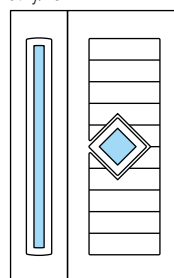



**KUBO/ZX**

Colore: Grigio P7000 Mix  
Maniglia: A 961

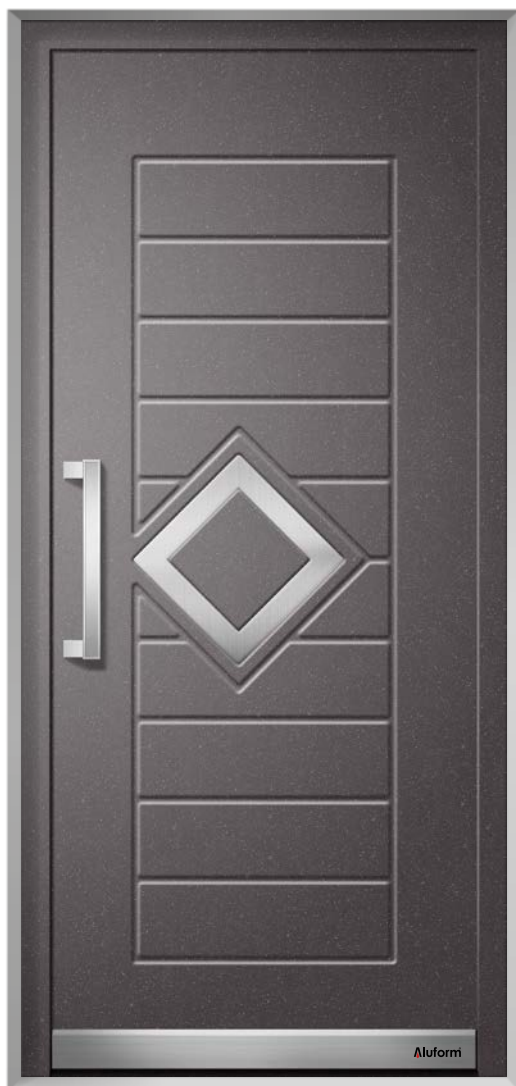

**KUBO/Z**

Colore: Cemento RP103M  
Maniglia: A 951 N



INFINITY

STYLE

A FILO

EMOTION

NOVECENTO

INCYSO

VETRI E DECORI

MANIGLIE

PENSILINE

COLORI

SEZ. TECNICA

Mirror/ZXS Kubo/ZX

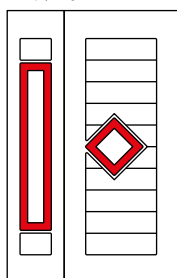

Over/ZS Kubo/Z

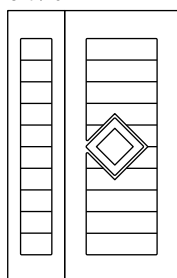



**JOLLY/ZS1**  
Colore: Corten RP101M  
Vetro: satinato D (31)

**JOLLY/ZM1**  
Colore: Corten RP101M  
Vetro: satinato D (31)  
Maniglia: A 619 (3 pezzi)

**JOLLY/ZXM**

Colore: Ciliegio RP02L  
Maniglia: A 687



**JOLLY/ZM**

Colore: Ambra AK40V Grinz  
Maniglia: A 944 N



INFINITY

STYLE

A FILO

EMOTION

NOVECENTO

INCYSO

VETRI E DECORI

MANIGLIE

PENSILINE

COLORI

SEZ. TECNICA

Jolly/ZS1    Jolly/ZM1

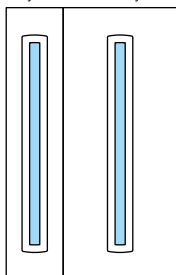

Jolly/ZXS    Jolly/ZXM

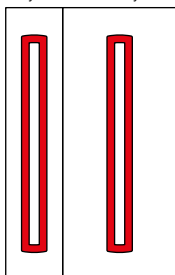

Jolly/ZS    Jolly/ZM

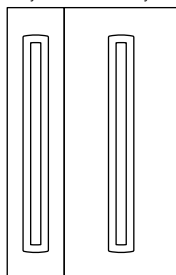

# CARATTERISTICHE TECNICHE

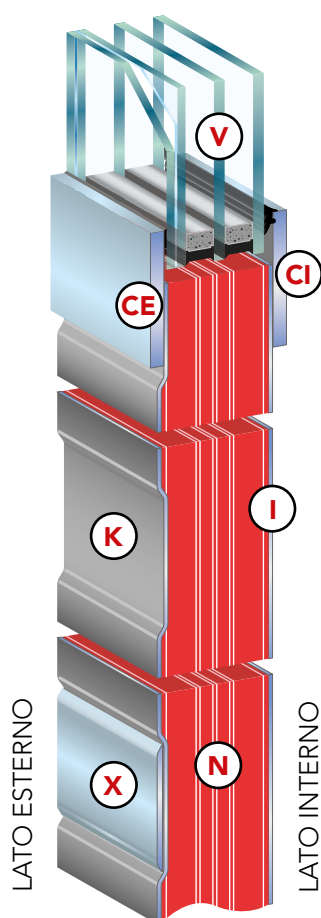

**CE - Cornice lato esterno** realizzata in acciaio inox AISI 316L satinato. Su richiesta, con finitura colore nero Ral 9005 Grinz.

**CI - Cornice lato interno** stesse caratteristiche e possibilità di personalizzazione della cornice sul lato esterno, può essere smontata e rimontata facilmente, per l'installazione e la sostituzione del vetro.

**K - Lavorazione decorativa** di circa 2 millimetri di profondità, ricavata sulla lastra di alluminio.

**I - Lato interno liscio** realizzato di serie dello stesso colore del lato esterno. Su richiesta, colori diversi e varianti decorative come indicate sotto.

**N - Nucleo** costituito da un mix di materiali particolarmente performanti, disposti in più strati, con ottime proprietà di isolamento termico ed abbattimento acustico. Materiali e prestazioni variano in base alla tipologia e allo spessore del pannello.

**V - Vetro isolante** fornito su richiesta, realizzato con doppio o triplo vetro in base allo spessore del pannello. In entrambe le soluzioni, il vetro esterno è stratificato e quello interno temprato, in conformità alle vigenti norme sulla sicurezza. Per consentire il fissaggio della cornice interna, lo spessore del vetro deve essere inferiore di almeno 8 mm rispetto a quello del pannello.

**X - Lavorazione decorativa** di circa 2 millimetri di profondità, ricavata sulla lastra di alluminio, nella quale è incastonato l'inserto in acciaio inox AISI 316L satinato. Su richiesta, con finitura colore nero Ral 9005 Grinz.

**LATO ESTERNO**

**Esempio**

**LATO**

**INTERNO (di serie)**

**Liscio**

**VARIANTI**

**DECORATIVE LATO INTERNO (su richiesta)**

**Light**

Lavorazione **K\***

**Double**

Uguale al lato esterno



\* La lavorazione **K** riproduce sempre lo stesso disegno del modello esterno. Per i modelli senza inserti sul lato esterno, le varianti Light e Double coincidono.

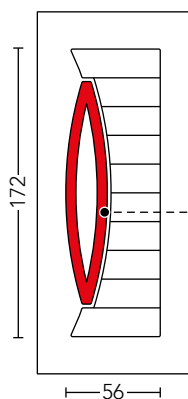

### DISEGNI E SIMBOLI

I disegni dei pannelli sono proporzionati alle dimensioni di cm 90 x 215 per l'anta principale e cm 45 x 215 per la mezza anta. Le quote indicate nei disegni (espresse in centimetri) indicano l'ingombro dell'area decorativa del modello. Con il termine area decorativa, si intende la parte lavorata del pannello che ne caratterizza il modello. L'area decorativa ha misure fisse e la sua posizione, rispetto al perimetro del pannello è sempre centrata (vedi figura in basso).

**Inserti.** I modelli con gli inserti sono indicati nei rispettivi disegni con la parte evidenziata in rosso.

### DIMENSIONI E SPESSORI

I pannelli sono disponibili nelle dimensioni e negli spessori indicati nell'apposito capitolo tecnico. Nella scelta del modello, valutare che l'ingombro dell'area decorativa non interferisca con il profilo perimetrale in cui è alloggiato il pannello. Il margine consigliato per garantire un buon risultato estetico, è di almeno un centimetro lungo tutto il perimetro del pannello, al netto della presa dello stesso all'interno del profilo.

**Taglio a misura.** Il taglio a misura viene eseguito su richiesta, con l'area decorativa del modello centrata rispetto al perimetro del pannello (vedi figura in basso). Per esigenze particolari, ma nei limiti consentiti dall'area decorativa e dalle dimensioni richieste, il taglio a misura può essere effettuato decentrato. L'eventuale fattibilità va richiesta tramite l'invio di un disegno quotato del modello.

### LIMITAZIONI

**Verso delle venature.** Tutti i colori effetto legno, avranno le venature disposte in senso verticale rispetto al pannello.

**Pannelli nei colori legno fuori cartella.** Saranno realizzati su richiesta presso impianti esterni. Per esigenze produttive, i pannelli con queste finiture avranno dei fori lungo i bordi verticali che ne riducono la misura utile in larghezza di circa 4 cm.

Fig. 1  
area decorativa  
centrata

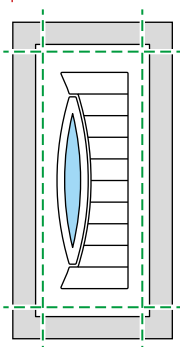

# DISEGNI

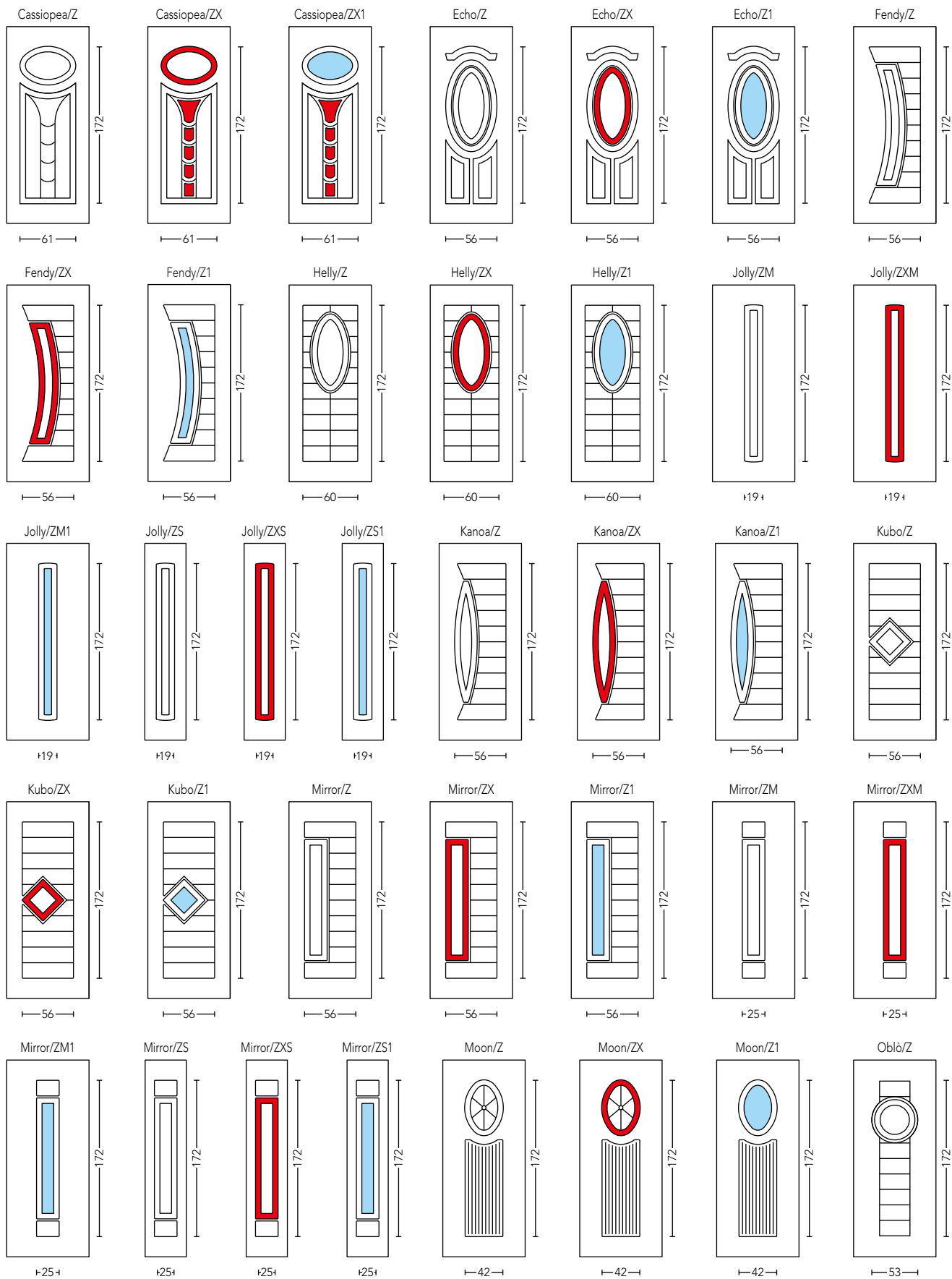

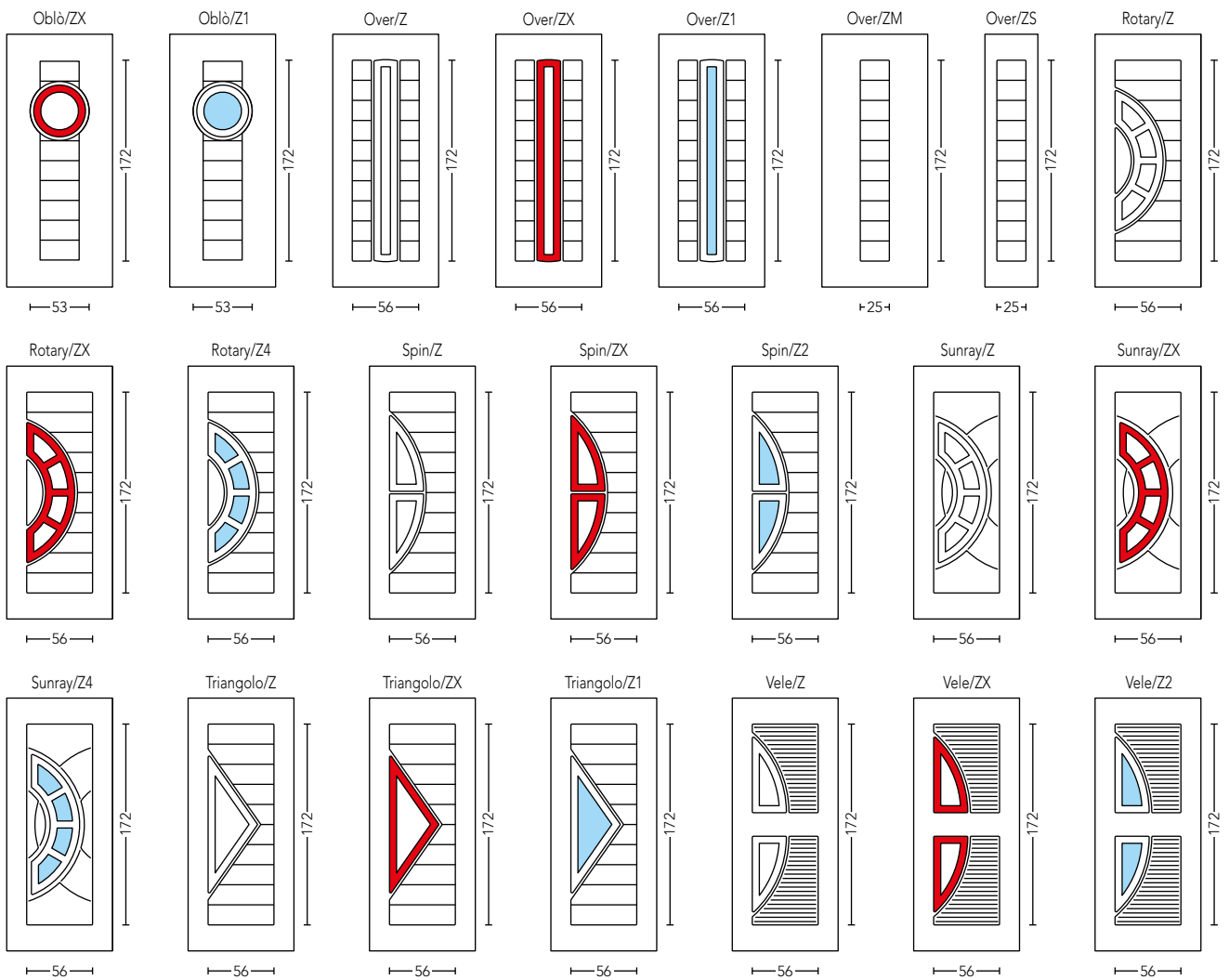





L'essenzialità delle forme!

# A FILO

Contemporanea, essenziale, dalle forme squadrate e rigorose, la collezione A Filo si caratterizza per lo stile accattivante e funzionale che rompe con gli schemi del passato.

INFINITY

STYLE

A FILO

EMOTION

NOVECENTO

INCISO

VETRI E DECORI

MANIGLIE

PENSILINE

COLORI

SEZ. TECNICA

# INDICE

**AMBRA/F**  
Pag. 107



**AMBRA/H**  
Pag. 107



**AMBRA/MF**  
Pag. 107



**AMBRA/MH**  
Pag. 107



**AMBRA/MH1**  
Pag. 108



**AMBRA/MH4**  
Pag. 109



**AMBRA/MH5**  
Pag. 109



**AMBRA/FB**  
Pag. 111



**AMBRA/FB1**  
Pag. 119



**AMBRA/FB4**  
Pag. 121



**AMBRA/FB5**  
Pag. 123



**AMBRA/HB**  
Pag. 111



**AMBRA/HB1**  
Pag. 119



**AMBRA/HB4**  
Pag. 121



**AMBRA/HB5**  
Pag. 123



**AMBRA/MFB**  
Pag. 111



**AMBRA/MFB1**  
Pag. 119



**AMBRA/MFB4**  
Pag. 121



**AMBRA/MFB5**  
Pag. 123



**AMBRA/MHB**  
Pag. 110



**AMBRA/MHB1**  
Pag. 118



**AMBRA/MHB4**  
Pag. 120



**AMBRA/MHB5**  
Pag. 122



**AMBRA/MHAX**  
Pag. 115



**AMBRA/MHNX**  
Pag. 115



**AMBRA/MHPO**  
Pag. 112



**AMBRA/MHSM**  
Pag. 113



**AMBRA/MHSP**  
Pag. 112



**AMBRA/MHSX**  
Pag. 114



**AMBRA/MHTE**  
Pag. 113

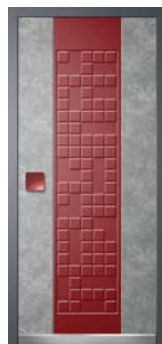

**AMBRA/MHC1**  
Pag. 116



**AMBRA/FF**  
Pag. 125



**AMBRA/HF**  
Pag. 125



**AMBRA/MFF**  
Pag. 124



**AMETISTA/F**  
Pag. 107



**AMETISTA/FB**  
Pag. 106



**AMETISTA/FB1**  
Pag. 106



**AMETISTA/HB**  
Pag. 106



**AMETISTA/HB1**  
Pag. 106



**AMETISTA/MFB**  
Pag. 106



**AMETISTA/MFB1**  
Pag. 106



**AMETISTA/MHB**  
Pag. 106



**AMETISTA/MHB1**  
Pag. 106



**COBALTO/F**  
Pag. 149



INFINITY

STYLE

A FILO

EMOTION

NOVECENTO

INCYSO

VETRI E DECORI

MANIGLIE

PENSILINE

COLORI

SEZ. TECNICA

# INDICE

**COBALTO/F1**  
Pag. 145



**COBALTO/F3**  
Pag. 147



**COBALTO/H**  
Pag. 149



**COBALTO/H1**  
Pag. 145



**COBALTO/H3**  
Pag. 147



**COBALTO/MF**  
Pag. 148



**COBALTO/MF1**  
Pag. 144



**COBALTO/MF3**  
Pag. 146



**CORALLO/F**  
Pag. 153



**CORALLO/H**  
Pag. 153



**CORALLO/MF**  
Pag. 152



**DIAMOND/MHD**  
Pag. 105



**DIAMOND/MHD1**  
Pag. 104



**GIADA/F**  
Pag. 150



**GIADA/H**  
Pag. 151



**KREO/FA**  
Pag. 178



**KREO/HA**  
Pag. 179



**KREO/MFA**  
Pag. 179



**KREO/MHA**  
Pag. 179



**KREO/MFB**  
Pag. 180



**KREO/MFB5**  
Pag. 180



**KREO/MHB**  
Pag. 181



**KREO/MHB5**  
Pag. 180



**QUARZO/FC**  
Pag. 165



**QUARZO/HC**  
Pag. 165



**QUARZO/MFC**  
Pag. 165



**QUARZO/MHC**  
Pag. 164



**QUARZO/FD**  
Pag. 167



**QUARZO/HD**  
Pag. 166



**QUARZO/MFD**  
Pag. 167



**QUARZO/MHD**  
Pag. 166



**QUARZO/FE**  
Pag. 169



**QUARZO/HE**  
Pag. 169



**QUARZO/MFE**  
Pag. 169



**QUARZO/MHE**  
Pag. 168



**QUARZO/FF**  
Pag. 170



**QUARZO/FF5**  
Pag. 171



**QUARZO/HF**  
Pag. 170



**QUARZO/HF5**  
Pag. 171



**QUARZO/MFF**  
Pag. 174



**QUARZO/MHF**  
Pag. 174



**QUARZO/MFG**  
Pag. 173



**QUARZO/MHG**  
Pag. 173



**QUARZO/MHG3**  
Pag. 172



**QUARZO/MFL**  
Pag. 175



**QUARZO/MHL**  
Pag. 175



**RIGO/FB**  
Pag. 183



**RIGO/HB**  
Pag. 183



INFINITY

STYLE

A FILO

EMOTION

NOVECENTO

INCYSO

VETRI E DECORI

MANIGLIE

PENSILINE

COLORI

SEZ. TECNICA

# INDICE

**RIGO/MFB**  
Pag. 183



**RIGO/MHB**  
Pag. 183



**RIGO/FC**  
Pag. 184



**RIGO/HC**  
Pag. 184



**RIGO/MFC**  
Pag. 184



**RIGO/MHC**  
Pag. 184



**RIGO/FD**  
Pag. 185



**RIGO/HD**  
Pag. 185



**RIGO/MFD**  
Pag. 185



**RIGO/MHD**  
Pag. 185



**RIGO/FE**  
Pag. 186



**RIGO/HE**  
Pag. 187



**RIGO/MFE**  
Pag. 187



**RIGO/MHE**  
Pag. 187



**RIGO/FF**  
Pag. 188



**RIGO/HF**  
Pag. 188



**RIGO/MFF**  
Pag. 188



**RIGO/MHF**  
Pag. 188



**RIGO/FG**  
Pag. 189



**RIGO/HG**  
Pag. 189



**RIGO/MFG**  
Pag. 189



**RIGO/MHG**  
Pag. 189



**RIGO/FH**  
Pag. 190



**RIGO/HH**  
Pag. 191



**RIGO/MFH**  
Pag. 191



**RIGO/MHH**  
Pag. 191



**RUBINO/F**  
Pag. 155



**RUBINO/F1**  
Pag. 157



**RUBINO/H**  
Pag. 155



**RUBINO/H1**  
Pag. 157



**RUBINO/MF**  
Pag. 154



**RUBINO/MF1**  
Pag. 156



**RUBINO/MH**  
Pag. 155



**RUBINO/MH1**  
Pag. 157



**RUBINO/FG**  
Pag. 159



**RUBINO/HG**  
Pag. 159



**RUBINO/MFG**  
Pag. 158



**SMERALDO/H**  
Pag. 177



**SMERALDO/MH**  
Pag. 176



**TOPAZIO/FD**  
Pag. 163



**TOPAZIO/FD3**  
Pag. 163



**TOPAZIO/HD**  
Pag. 162



**TOPAZIO/HD3**  
Pag. 163



**TOPAZIO/MFB**  
Pag. 161



**TOPAZIO/MHB**  
Pag. 160



**TOPAZIO/MFC**  
Pag. 162



**TOPAZIO/MHC**  
Pag. 162



**TOPAZIO/MFE**  
Pag. 161



# INDICE

**TOPAZIO/MHE**  
Pag. 161



**ZAFFIRO/F**  
Pag. 127



**ZAFFIRO/F4**  
Pag. 129



**ZAFFIRO/H**  
Pag. 127



**ZAFFIRO/H4**  
Pag. 129



**ZAFFIRO/MF**  
Pag. 127



**ZAFFIRO/MF4**  
Pag. 129



**ZAFFIRO/MH**  
Pag. 127



**ZAFFIRO/MH1**  
Pag. 126



**ZAFFIRO/MH4**  
Pag. 128



**ZAFFIRO/FB**  
Pag. 133



**ZAFFIRO/FB1**  
Pag. 131



**ZAFFIRO/FB2**  
Pag. 135



**ZAFFIRO/HB**  
Pag. 133



**ZAFFIRO/HB1**  
Pag. 131



**ZAFFIRO/HB2**  
Pag. 135



**ZAFFIRO/MFB**  
Pag. 132



**ZAFFIRO/MFB1**  
Pag. 130



**ZAFFIRO/MFB2**  
Pag. 134



**ZAFFIRO/FC**  
Pag. 137



**ZAFFIRO/HC**  
Pag. 137



**ZAFFIRO/MFC**  
Pag. 136



**ZAFFIRO/FD**  
Pag. 139



**ZAFFIRO/FD3**  
Pag. 141





**ZAFFIRO/HD**  
Pag. 139



**ZAFFIRO/HD3**  
Pag. 141



**ZAFFIRO/MFD**  
Pag. 138



**ZAFFIRO/MFD3**  
Pag. 140



**ZAFFIRO/FE**  
Pag. 142



**ZAFFIRO/FE5**  
Pag. 143



**ZAFFIRO/HE**  
Pag. 142



**ZAFFIRO/HE5**  
Pag. 143



**ZAFFIRO/MFE**  
Pag. 142



**ZAFFIRO/MFE5**  
Pag. 143



INFINITY

STYLE

**A FILO**

EMOTION

NOVECENTO

INCISO

VETRI E DECORI

MANIGLIE

PENSILINE

COLORI

SEZ. TECNICA



Aluformi

**TABLET/YS**

Colore: RAL 8014 Grinz

**DIAMOND/MHD1**

Colore base: RAL 8014 Grinz

2° colore: RAL 7044 Grinz

Vetro: decoro GS (72)

Maniglia: A 951 X (RAL 8014 Grinz)

**DIAMOND/MHD**

Colore Base: RAL 9005 Grinz  
2° Colore: Ciliegio RP02L  
Maniglia: A 944 N



**DIAMOND/MH**

Colore Base: RAL 7011 Grinz  
2° Colore: Ghisa RP102M  
Maniglia: A 943 X (RAL 7011 Grinz)



INFINITY

STYLE

**A FILO**

EMOTION

NOVECENTO

INCYSO

VETRI E DECORI

MANIGLIE

PENSILINE

COLORI

SEZ. TECNICA

Tablet/YS Diamond/MHD1

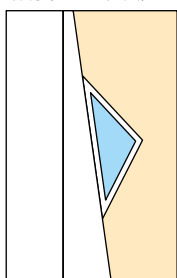

Diamond/MH1

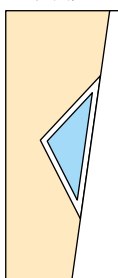

Jolly/WG1 Diamond/MHD

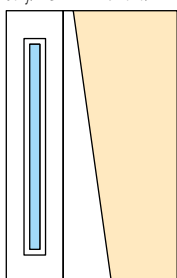

Diamond/MH

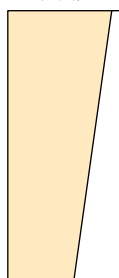

**A FILO**  
COLLECTION

**AMETISTA/MFB**

Colore: RAL 7035 Grinz  
2° Colore: RAL 3003 lucido  
Inserti: RAL 9005 Lucido\*  
Maniglia: A 963 N



**AMETISTA/MHB1**

Colore: RAL 7035 Grinz  
2° Colore: RAL 9005 lucido  
Cornice vetro: RAL 9005 lucido\*  
Vetro: dec. GC (31) - Man: A 963 N



**AMETISTA/FB1**

Colore: RAL 7035 Grinz  
Inserti: RAL 9005 Lucido\*  
Vetro: satinato A (31)  
Maniglia: A 963 N



Ametista/FB

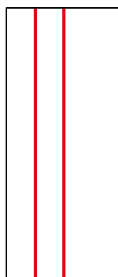

Ametista/FB1

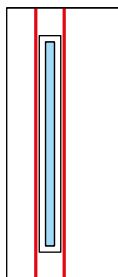

Ametista/HB

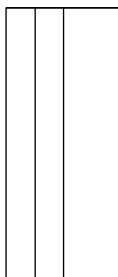

Ametista/HB1

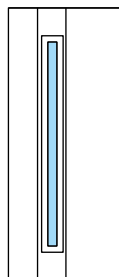

Ametista/MFB

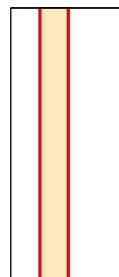

Ametista/MFB1

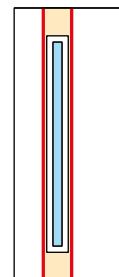

Ametista/MHB

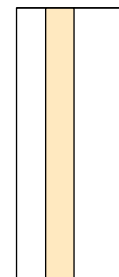

Ametista/MHB1

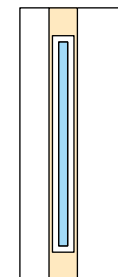

**AMETISTA/F**

Colore: RAL 7016 Grinz  
Inserti: RAL 3003 Lucido\*  
Maniglia: A 942 R



**AMBRA/MH**

Colore base: RAL 3005 Grinz  
2° Colore: Abete bianco RP14L  
Maniglia: A 619 (3 pezzi)



**AMBRA/MF**

Colore base: RAL 7044 Grinz  
2° Colore: Corten RP101M  
Maniglia: A 942 X  
(Corten V001V Grinz Mix)



\* Soluzione su richiesta

Ametista/F

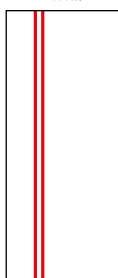

Ambra/MH

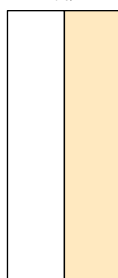

Ambra/MF

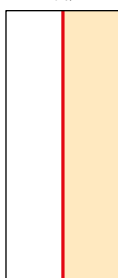

Ambra/F

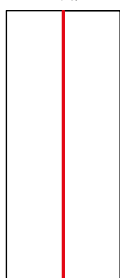

Ambra/H





**AMBRA/MH1**

Colore Base: RAL 8014 Grinz

2° Colore: Ciliegio RP03L

Vetro: decoro RC (31)

Maniglia: A 941 X (RAL 8014 Grinz)



Jolly/WG1      Ambra/MH1

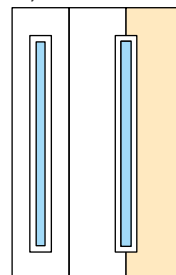

**AMBRA/MH4**

Colore Base: RAL 5003 Grinz  
2° Colore: Abete bianco RP14L  
Vetro: rifle (26)  
Maniglia: A 962 X (RAL 5003 Grinz)



**AMBRA/MH5**

Colore Base: RAL 9005 Grinz  
2° Colore: RAL 9016 Grinz  
Vetro: satinato A (40)  
Maniglia: A 945 N



INFINITY

STYLE

**A FILO**

EMOTION

NOVECENTO

INCYSO

VETRI E DECORI

MANIGLIE

PENSILINE

COLORI

SEZ. TECNICA

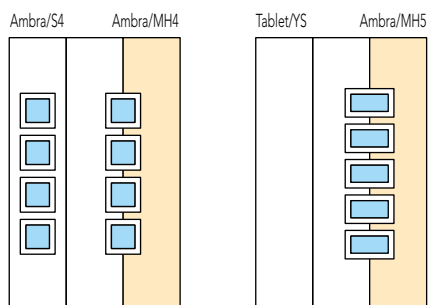



**JOLLY/WG1**

Colore: RAL 6009 Grinz  
Vetro: decoro GC (31)

**AMBRA/MHB**

Colore Base: RAL 6009 Grinz  
2° Colore: RAL 6021 Lucido  
Maniglia: A 955 X (RAL 6021 Grinz)  
con illuminazione led



**AMBRA/MFB**

Colore Base: RAL 9005 Lucido  
2° Colore: Ghisa RP102M  
Inserti: RAL 3003 Lucido\*  
Maniglia: A 955 N



**AMBRA/FB**

Colore: RAL 9005 Grinz  
Maniglia: A 955



**AMBRA/HB**

Colore: RAL 9005 Grinz  
Maniglia: A 955 R



\* Soluzione su richiesta

Jolly/WG1    Ambra/MHB

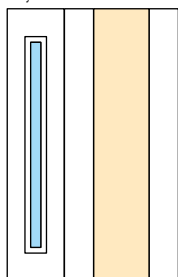

Ambra/S4    Ambra/MFB

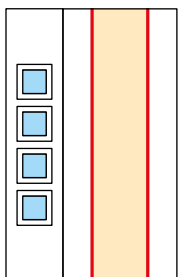

Tablet/YS    Ambra/FB

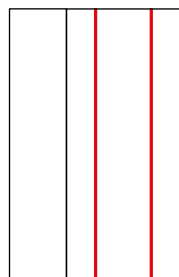

Ambra/HB

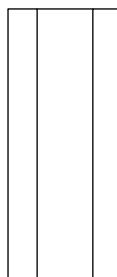

**A FILO**  
COLLECTION

**AMBRA/MHSP**

Colore Base: Bleu AK15V Grinz  
2° Colore: Ciliegio RP03L  
Maniglia: A 972 C



**AMBRA/MHPO**

Colore base: Ghisa RP102M  
2° Colore: RAL 9005 Grinz  
Maniglia: A 946 R



Jolly/WG1 Ambra/MHSP

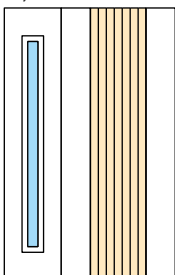

Tablet/YS Ambra/MHPO

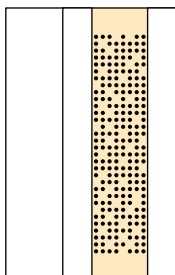

**AMBRA/MHTE**

Colore Base: Cemento RP103 M  
2° Colore: RAL 3004 Grinz  
Maniglia: A 945 X (RAL 3004 Grinz)

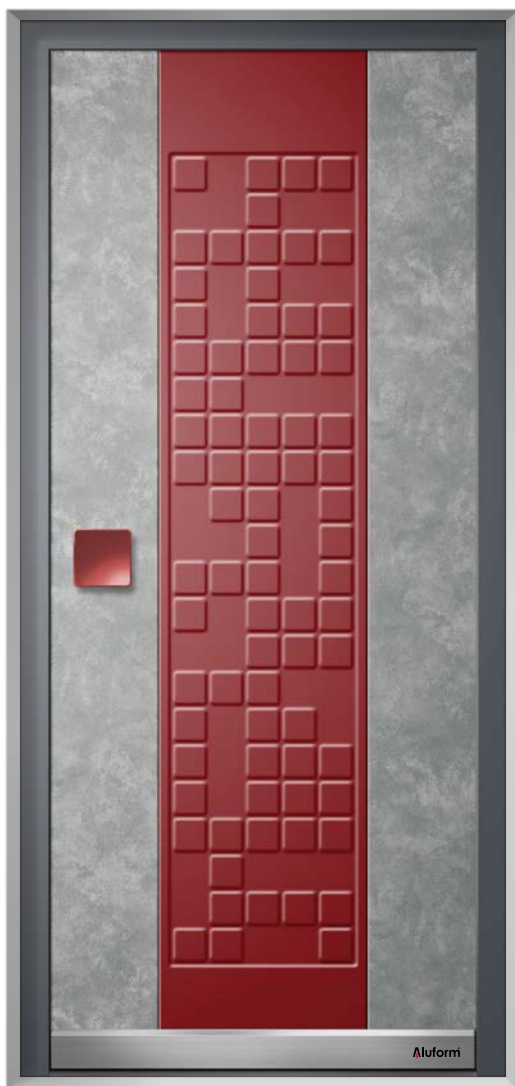

**AMBRA/MHSM**

Colore Base: RAL 6009 Grinz  
2° Colore: RAL 6009 Lucido  
Maniglia: A 693



INFINITY

STYLE

**A FILO**

EMOTION

NOVECENTO

INCYSO

VETRI E DECORI

MANIGLIE

PENSILINE

COLORI

SEZ. TECNICA

Jolly/WG1      Ambra/MHTE

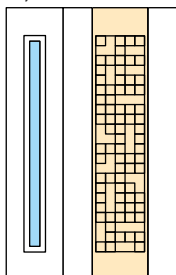

Tablet/YS      Ambra/MHSM

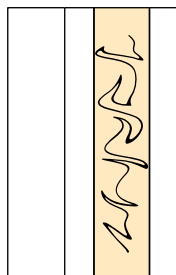



**TABLET/YS**

Colore: Bleu AK15V Grinz

**AMBRA/MHSX**

Colore Base: Bleu AK15V Grinz  
2° Colore: Orange AK38V Grinz  
Maniglia: A 944

**AMBRA/MHAX**

Colore Base: RAL 8014 Grinz  
2° Colore: RAL 5003 Grinz  
Maniglia: A 963 X (RAL 5003 Grinz)



**AMBRA/MHNX**

Colore Base: RAL 7030 Lucido  
2° Colore: RAL 7011 Grinz  
Maniglia: A 963 X (RAL 7011 Grinz)



INFINITY

STYLE

**A FILO**

EMOTION

NOVECENTO

INCYSO

VETRI E DECORI

MANIGLIE

PENSILINE

COLORI

SEZ. TECNICA

Tablet/YS Ambra/MHSX

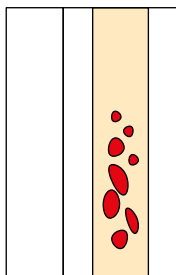

Jolly/WG1 Ambra/MHAX

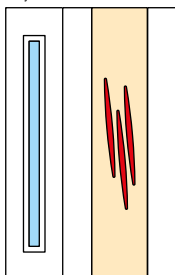

Tablet/YS Ambra/MHNX

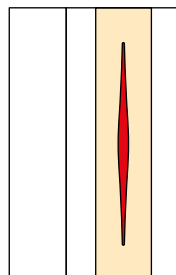

**A FILO**  
COLLECTION

**AMBRA/MHC1**

Colore Base: RAL 9003 Grinz  
2° Colore: RAL 9005 Grinz  
Cornice: RAL 9005 Grinz\* - Vetro: rifle (38)  
Maniglia: A 971 N



**AMBRA/MHC1**

Colore Base: RAL 5003 Lucido  
2° Colore: RAL 3005 Grinz  
Cornice: RAL 3005 Grinz\* - Vetro: decoro GC (38)  
Maniglia: A 973 X (RAL 5003 Grinz)



Tablet/YS Ambra/MHC1

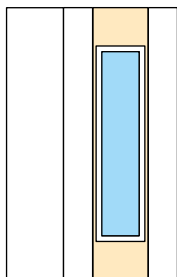

Jolly/WG1 Ambra/MHC1

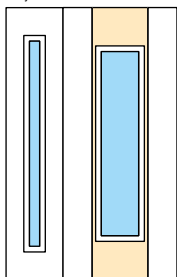

**AMBRA/MHC1**

Colore Base: RAL 7035 Lucido  
2° Colore: RAL 8019 Grinz  
Cornice: RAL 8019 Grinz\* - Vetro: decoro AS (38)  
Maniglia: A 955 N



**AMBRA/MHC1**

Colore Base: Corten RP101M  
2° Colore: Corten V001V Grinz Mix  
Cornice: Corten V001V\* - Vetro: decoro FU (38)  
Maniglia: A 961 C



INFINITY

STYLE

**A FILO**

EMOTION

NOVECENTO

INCYSO

VETRI E DECORI

MANIGLIE

PENSILINE

COLORI

SEZ. TECNICA

\* Soluzione su richiesta

VARIANTI VETRO

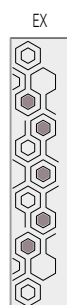
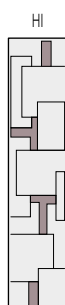
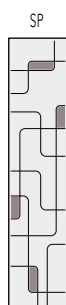
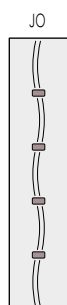



**AMBRA/HPS**

Colore: RAL 7035 Grinz

**AMBRA/MHB1**

Colore Base: Bleu AK15V Grinz

2° Colore: RAL 7035 Grinz

Vetro: decoro RC (31)

Maniglia: A 973 X (Bleu AK15V Grinz)



**AMBRA/MFB1**

Colore Base: RAL 5003 Grinz  
2° Colore: RAL 5014 Grinz  
Vetro: decoro GC (31)  
Maniglia: A 963 X (RAL 5003 Grinz)



**AMBRA/FB1**

Colore: RAL 5003 Grinz  
Cornice: Alluminio effetto inox\*  
Vetro: decoro GS (31)  
Maniglia: A 963 X (RAL 5003 Grinz)



**AMBRA/HB1**

Colore: RAL 5003 Grinz  
Vetro: satinato A (31)  
Maniglia: A 963 X (RAL 5003 Grinz)



\* Soluzione su richiesta

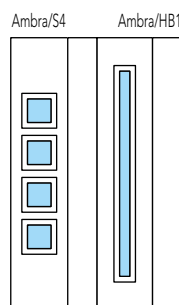
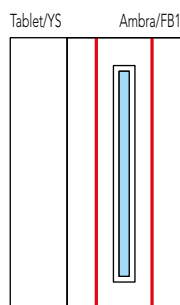
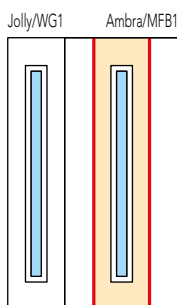
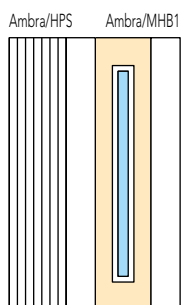



**TABLET/YS**

Colore: Abete bianco RP14L

**AMBRA/MHB4**

Colore Base: RAL 8019 Grinz  
2° Colore: Abete bianco RP14L  
Vetro: rifle (26)  
Maniglia: A 971 X (RAL 8019 Grinz)

**AMBRA/MFB4**

Colore Base: RAL 7032 Grinz  
2° Colore: Corten RP101M  
Cornice: effetto inox\* - Vetro: FN (26)  
Maniglia: A 971 C



**AMBRA/FB4**

Colore: RAL 7032 Grinz  
Cornice: alluminio effetto inox\*  
Vetro: decoro GS (26)  
Maniglia: A 971 X (RAL 8019 Grinz)



**AMBRA/HB4**

Colore: RAL 7032 Grinz  
Cornice vetro: RAL 8019 Grinz\*  
Vetro: decoro GC (26)  
Maniglia: A 971 R



\* Soluzione su richiesta

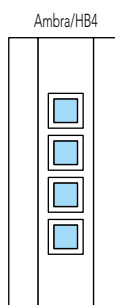
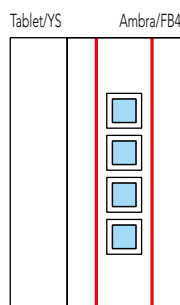
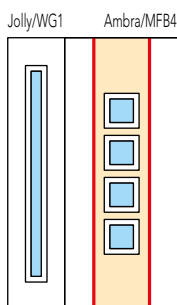
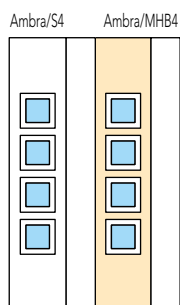



**QUARZO/HFS**

Colore: RAL 7016 Grinz

**AMBRA/MHB5**

Colore Base: RAL 7016 Grinz  
2° Colore: RAL 7030 Lucido  
Cornice vetro: RAL 7030 Lucido\*  
Vetro: decoro GS (40)  
Maniglia: A 953 R

**AMBRA/MFB5**

Colore Base: RAL 7040 Grinz  
2° Colore: Ghisa RP102M  
Inserti: RAL 3003 Lucido\*  
Cornice: RAL 9005 Grinz\* - Vetro: rifle (40)  
Maniglia: A 953 X (Ghisa RP102M)



**AMBRA/FB5**

Colore: RAL 7040 Grinz  
Inserti: RAL 9005 Lucido\*  
Vetro: decoro FN (40)  
Maniglia: A 953 N



**AMBRA/HB5**

Colore: RAL 7040 Grinz  
Vetro: decoro GC (40)  
Maniglia: A 953



\* Soluzione su richiesta

Quarzo/HFS Ambra/MHB5

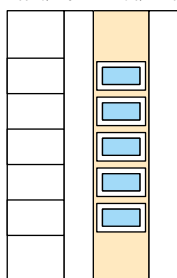

Jolly/WG1 Ambra/MFB5

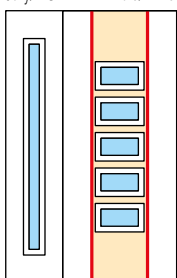

Tablet/YS Ambra/FB5

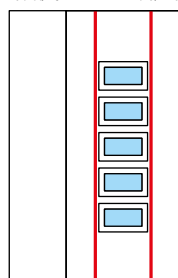

Ambra/HB5

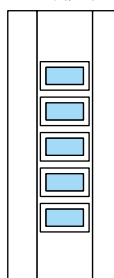



**AMBRA/MFF**

Colore Base: Ciliegio RP02L

2° Colore: RAL 9010 Grinz

Maniglia: A 962 N



Jolly/WG1

Ambra/MFF

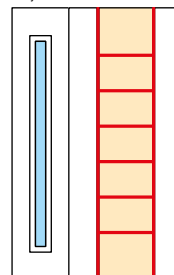

**AMBRA/FF**

Colore: Ciliegio RP02L  
Maniglia: A 962



**AMBRA/HF**

Colore: Ciliegio RP02L  
Maniglia: A 962 C



INFINITY

STYLE

**A FILO**

EMOTION

NOVECENTO

INCYSO

VETRI E DECORI

MANIGLIE

PENSILINE

COLORI

SEZ. TECNICA

Quarzo/FFS      Ambra/FF

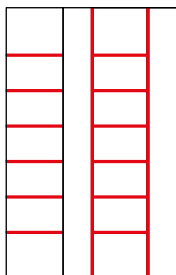

Tablet/YS      Ambra/HF

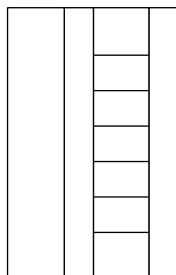

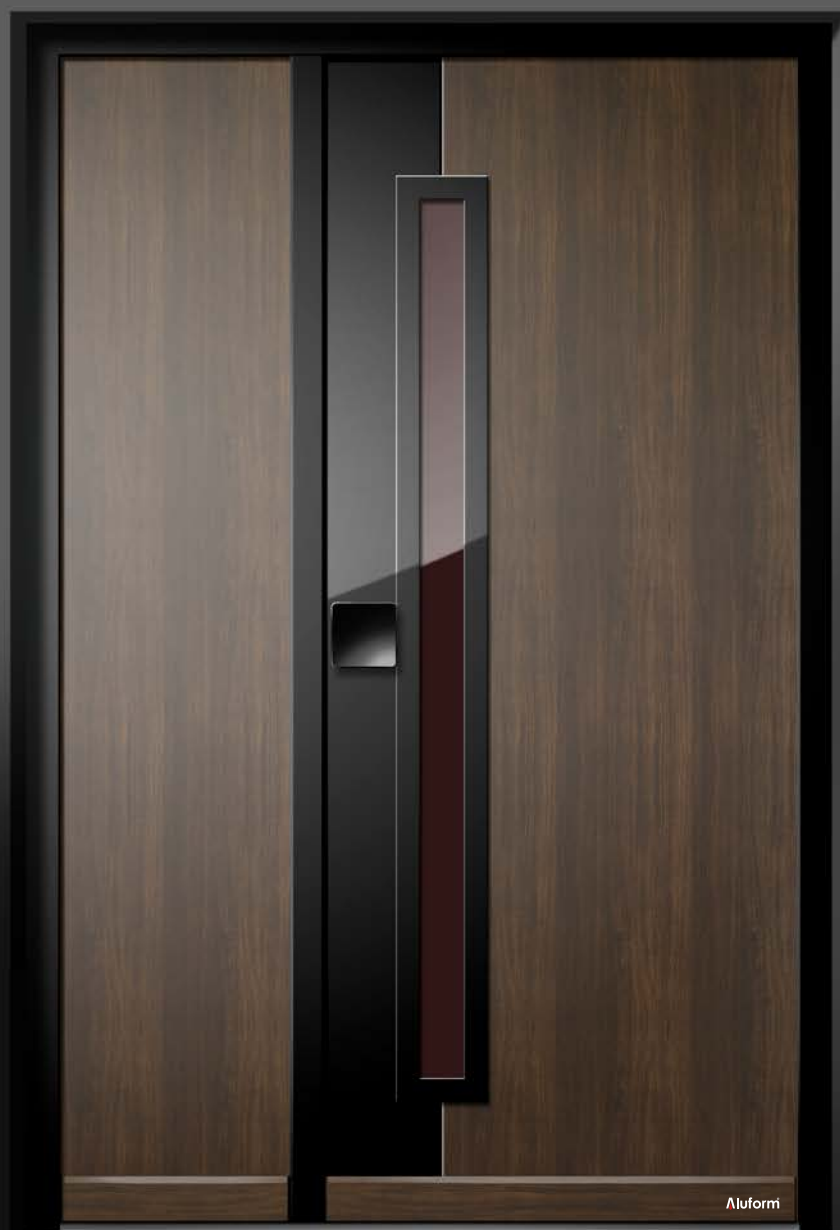

**TABLET/YS**

Colore: Noce RP05L

**ZAFFIRO/MH1**

Colore base: RAL 9005 Lucido

2° Colore: Noce RP05L

Vetro: rifle (31)

Maniglia: A 945 N



**ZAFFIRO/MH**

Colore Base: RAL 7035 Grinz  
2° Colore: RAL 3005 Grinz  
Maniglia: A 955 X  
(RAL 3005 Grinz)



**ZAFFIRO/MF**

Colore Base: RAL 7035 Grinz  
2° Colore: RAL 8019 Grinz  
Inserito: RAL 3003 Lucido\*  
Maniglia: A 952 R



**ZAFFIRO/F**

Colore Base: RAL 7035 Grinz  
Inserito: RAL 8019 Grinz\*  
Maniglia: A 619 (3 pezzi)



\* Soluzione su richiesta

Tablet/YS      Zaffiro/MH1

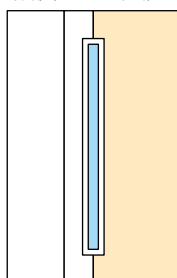

Jolly/WG1      Zaffiro/MH

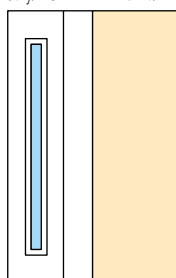

Ambra/S4      Zaffiro/MF

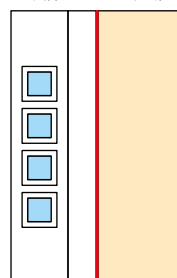

Zaffiro/F

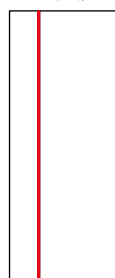

Zaffiro/H

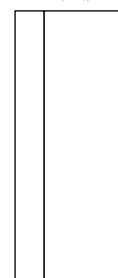



**JOLLY/WG1**

Colore: Antracite P016V Grinz  
Vetro: decoro GS (31)

**ZAFFIRO/MH4**

Colore Base: RAL 9016 Grinz  
2° Colore: Antracite P016V Grinz  
Cornici vetro: Antracite P016V Grinz\*  
Vetro: decoro GS (26)  
Maniglia: A 972 N

**ZAFFIRO/MF4**

Colore Base: RAL 7038 Grinz  
2° Colore: RAL 7005 Grinz  
Vetro: rifle (26)  
Maniglia: A 962 X (RAL 7005 Grinz)



**ZAFFIRO/F4**

Colore: RAL 7038 Grinz  
Inserto: RAL 7016 Lucido\*  
Vetro: decoro FN (26)  
Maniglia: A 962 X (RAL 7038 Grinz)



**ZAFFIRO/H4**

Colore: RAL 7038 Grinz  
Cornici vetro: RAL 7016 Grinz\*  
Vetro: decoro GC (26)  
Maniglia: A 962 X (RAL 7016 Grinz)



\* Soluzione su richiesta

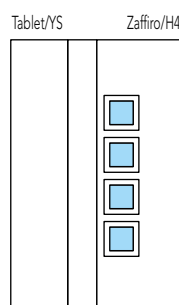
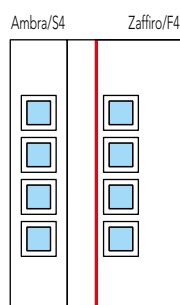
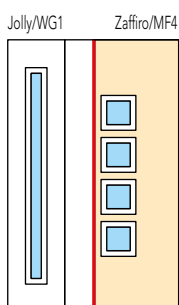
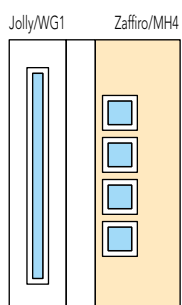



**RUBINO/FS**

Colore: RAL 7016 Grinz

**ZAFFIRO/MFB1**

Colore Base: Melon AK 37V Grinz  
2° Colore: RAL 7016 Grinz  
Cornice vetro: RAL 7016 Grinz\*  
Vetro: rifle (77)  
Maniglia: A 952 X (RAL 7016 Grinz)  
con illuminazione a led

**ZAFFIRO/FB1**

Colore: RAL 7016 Grinz  
Vetro: decoro GC (77)  
Maniglia: A 945 X (RAL 5003 Grinz)



**ZAFFIRO/HB1**

Colore: RAL 7016 Grinz  
Vetro: decoro FL (77)  
Maniglia: A 945



INFINITY

STYLE

**A FILO**

EMOTION

NOVECENTO

INCYSO

VETRI E DECORI

MANIGLIE

PENSILINE

COLORI

SEZ. TECNICA

\* Soluzione su richiesta

Rubino/FS      Zaffiro/MFB1

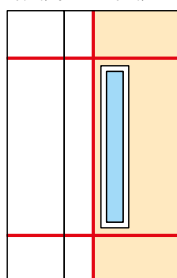

Rubino/FS1      Zaffiro/FB1

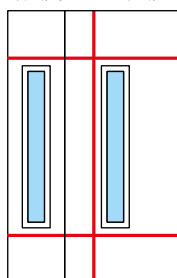

Rubino/HS      Zaffiro/HB1

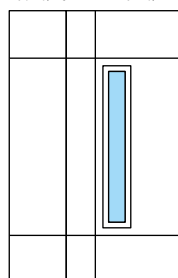

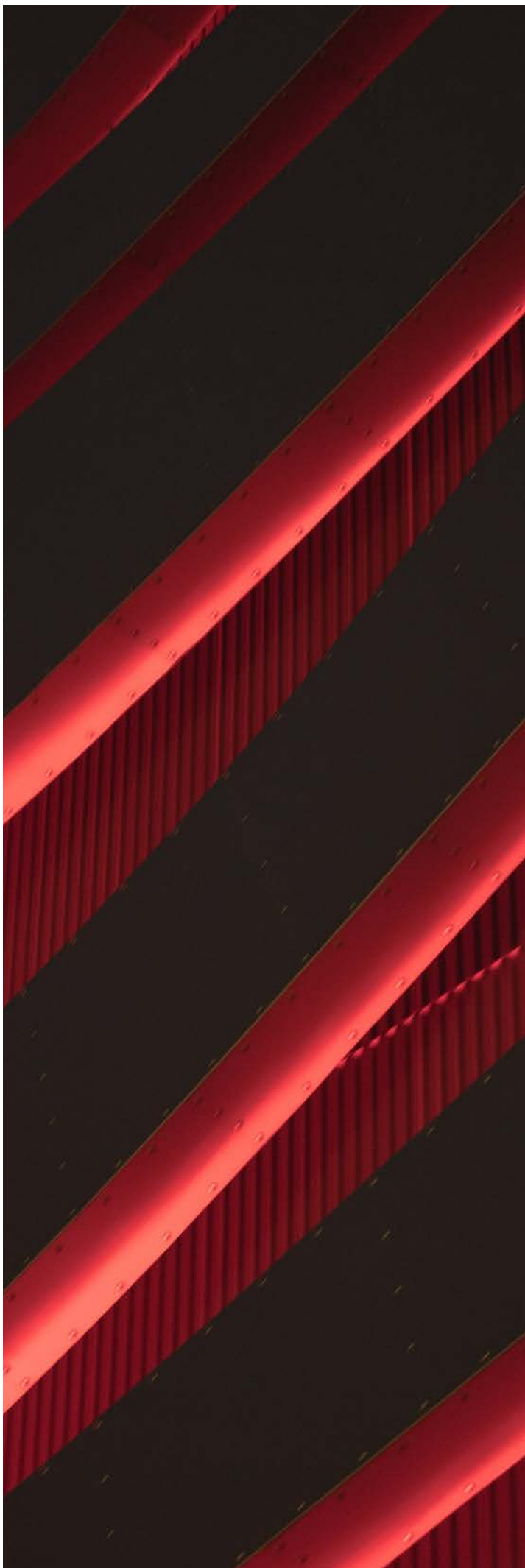

**ZAFFIRO/MFB**

Colore Base: Antracite P016V Grinz

2° Colore: Abete bianco RP14L

Inserti: RAL 3003 Lucido\*

Maniglia: A 942 N



Jolly/WG1

Zaffiro/MFB

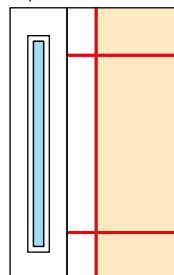

**ZAFFIRO/FB**

Colore: Antracite P016V Grinz  
Maniglia: A 942



**ZAFFIRO/HB**

Colore: Antracite P016V Grinz  
Maniglia: A 942 R



INFINITY

STYLE

**A FILO**

EMOTION

NOVECENTO

INCYSO

VETRI E DECORI

MANIGLIE

PENSILINE

COLORI

SEZ. TECNICA

\* Soluzione su richiesta

Rubino/FS1      Zaffiro/FB

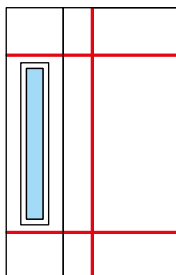

Rubino/HS      Zaffiro/HB

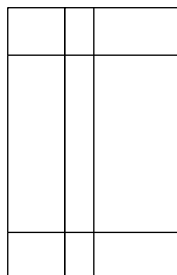

Tablet/YS      Zaffiro/HB

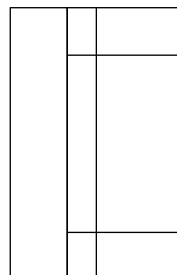



**RUBINO/FS**

Colore: RAL 7005 Grinz

**ZAFFIRO/MFB2**

Colore base: RAL 7035 Grinz  
2° colore RAL 7005 Grinz  
Cornice vetro: RAL 7005 Grinz\*  
Inserti: RAL 9005 Lucido\*  
Vetro: decoro ST (72)  
Maniglia: A 952 X (RAL 7005 Grinz)  
con illuminazione a led



**ZAFFIRO/FB2**

Colore: RAL 7035 Grinz - Insetti: RAL 9005 Lucido\*  
Cornice vetro: effetto inox\* - Vetro: decoro GC (72)  
Maniglia: A 952 R



**ZAFFIRO/HB2**

Colore: RAL 7035 Grinz  
Cornice vetro: RAL 9005 Grinz\*  
Vetro: decoro FN (72)  
Maniglia: A 952



\* Soluzione su richiesta

Jolly/WG1      Zaffiro/MFB2

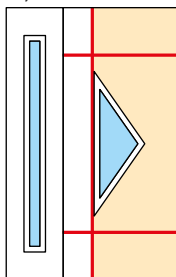

Rubino/FS1      Zaffiro/FB2

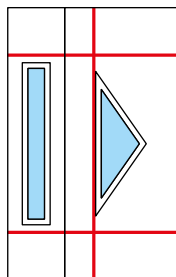

Rubino/HS      Zaffiro/HB2

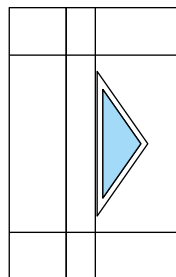

Tablet/YS      Zaffiro/HB2

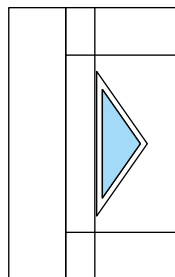



**ZAFFIRO/MFC**

Colore Base: Ciliegio RP03L

2° Colore: Ghisa RP102M

Inserti: RAL 9005 Lucido\*

Maniglia: A 945 N



Jolly/WG1

Zaffiro/MFC

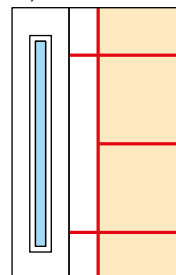

**ZAFFIRO/FC**

Colore: Ghisa RP102M  
Maniglia: A 945



**ZAFFIRO/HC**

Colore: Ghisa RP102M  
Maniglia: A 945 R

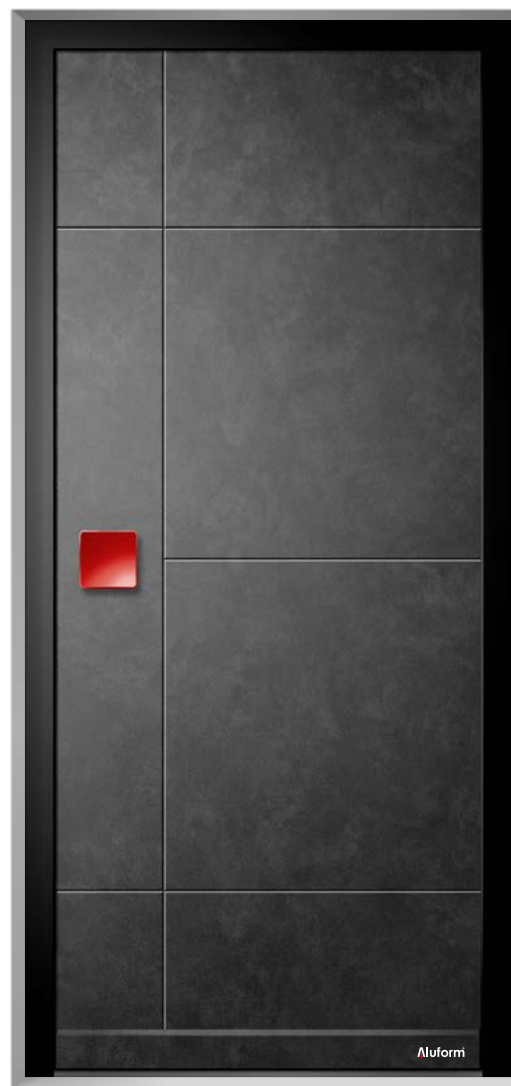

INFINITY

STYLE

**A FILO**

EMOTION

NOVECENTO

INCYSO

VETRI E DECORI

MANIGLIE

PENSILINE

COLORI

SEZ. TECNICA

\* Soluzione su richiesta

Rubino/FS1      Zaffiro/FC

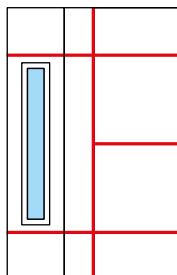

Rubino/HS      Zaffiro/HC

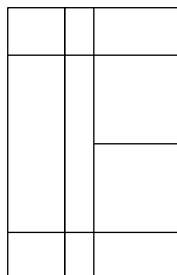

Tablet/YS      Zaffiro/HC

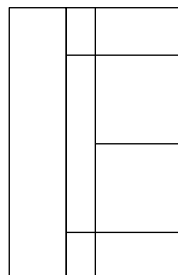



**ZAFFIRO/MFD**

Colore Base: RAL 7035 Grinz  
2° Colore: Ciliegio PVC RP04L  
Maniglia: A 703



Jolly/WG1      Zaffiro/MFD

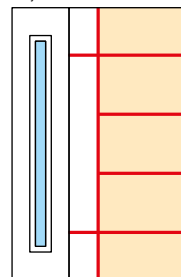

**ZAFFIRO/FD**

Colore: Beige AK12V Grinz Mix  
Inserti: RAL 9005 Lucido\*  
Maniglia: A 962 N



**ZAFFIRO/HD**

Colore: Beige AK12V Grinz Mix  
Maniglia: A 962 R



\* Soluzione su richiesta

Topazio/FDS3    Zaffiro/FD

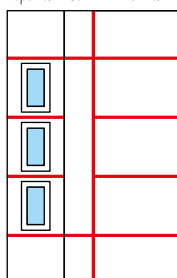

Topazio/HDS    Zaffiro/HD

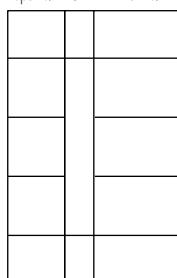

Tablet/YS    Zaffiro/HD

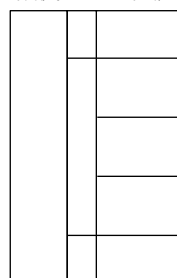



**RUBINO/FS**

Colore: Corten RP101M

**ZAFFIRO/MFD3**

Colore Base: RAL 8017 Grinz  
2° Colore: Corten RP101M  
Vetro: rifle (40)  
Maniglia: A 953 C  
con illuminazione a led

**ZAFFIRO/FD3**

Colore: Bronzo TR03V Grinz  
Cornici vetro: alluminio effetto inox\*  
Vetro: decoro GC (40)  
Maniglia: A 953



**ZAFFIRO/HD3**

Colore: Bronzo TR03V Grinz  
Vetro: decoro GS (40)  
Maniglia: A 946



INFINITY

STYLE

**A FILO**

EMOTION

NOVECENTO

INCYSO

VETRI E DECORI

MANIGLIE

PENSILINE

COLORI

SEZ. TECNICA

\* Soluzione su richiesta

Topazio/FDS3    Zaffiro/MFD3

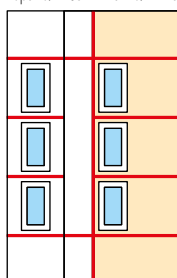

Topazio/FDS    Zaffiro/FD3

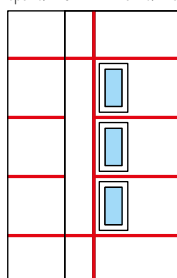

Topazio/HDS3    Zaffiro/HD3

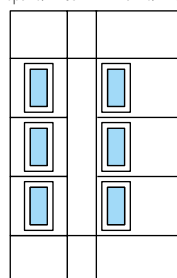

Topazio/HDS    Zaffiro/HD3

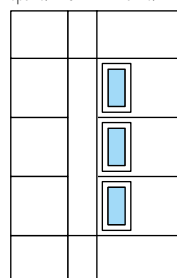

**A FILO**  
COLLECTION

**ZAFFIRO/MFE**

Colore Base: RAL 7044 Grinz  
2° Colore: RAL 8017 Grinz  
Maniglia: A 963



**ZAFFIRO/FE**

Colore: RAL 7044 Grinz  
Inseri: RAL 8017 Grinz\*  
Maniglia: A 963 X  
(RAL 8017 Grinz)



**ZAFFIRO/HE**

Colore: RAL 7044 Grinz  
Maniglia: A 963 X  
(RAL 8017 Grinz)



Jolly/WG1      Zaffiro/MFE

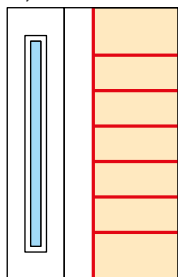

Quarzo/FFS      Zaffiro/FE

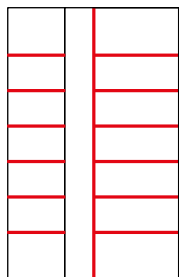

Quarzo/HFS      Zaffiro/HE

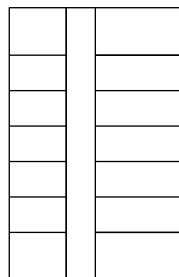

Tablet/YS      Zaffiro/HE

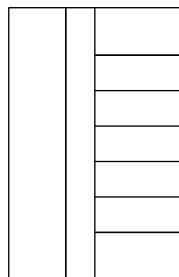



**ZAFFIRO/MFE5**

Colore Base: RAL 5003 Grinz  
2° Colore: Cemento RP103M  
Vetro: riflette (40)  
Maniglia: A 624



**ZAFFIRO/FE5**

Colore Base: RAL 5003 Grinz  
Vetro: decoro GS (40)  
Maniglia: A 624



**ZAFFIRO/HE5**

Colore Base: RAL 5003 Grinz  
Vetro: decoro GC (40)  
Maniglia: A 624



\* Soluzione su richiesta

Jolly/WG1    Zaffiro/MFE5

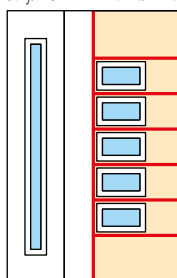

Quarzo/FFS    Zaffiro/FE5

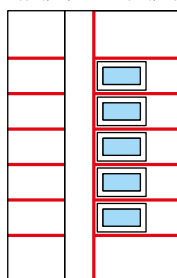

Quarzo/HFS    Zaffiro/HE5

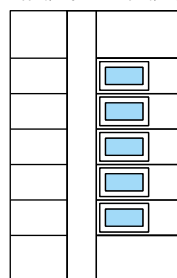



**RUBINO/MFS1**

Colore Base: Ciliegio RP02L  
2° Colore: RAL 9005 Lucido  
Cornice vetro: RAL 9005 Lucido\*  
Vetro: rifle (77)

**COBALTO/MF1**

Colore Base: Ciliegio RP02L  
2° Colore: RAL 9005 Lucido  
Cornice vetro: RAL 9005 Lucido\*  
Vetro: rifle (77)  
Maniglia: A 622

**COBALTO/F1**

Colore: RAL 8011 Grinz  
Vetro: decoro RC (77)  
Maniglia: A 622



**COBALTO/H1**

Colore: RAL 8011 Grinz  
Cornice vetro: alluminio effetto inox\*  
Vetro decoro JO (77)  
Maniglia: A 622



\* Soluzione su richiesta

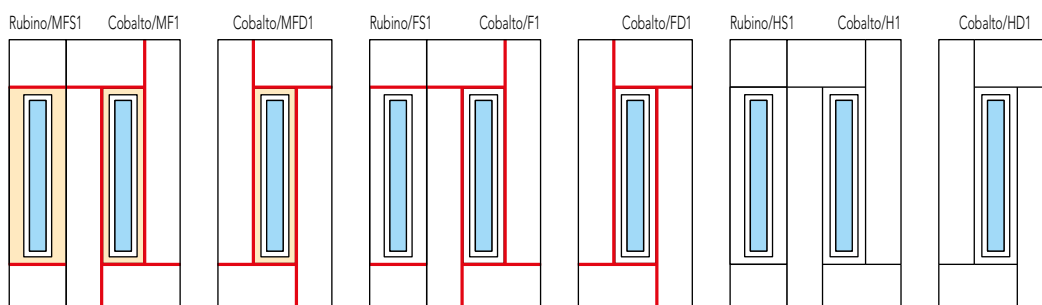

INFINITY

STYLE

**A FILO**

EMOTION

NOVECENTO

INCYSO

VETRI E DECORI

MANIGLIE

PENSILINE

COLORI

SEZ. TECNICA



**COBALTO/MF3**

Colore Base: RAL 7038 Grinz

2° Colore: RAL 7016 Lucido

Inserti: RAL 7016 Lucido\*

Vetro: rifle (40) - Maniglia: A 972 N



Rubino/MFS

Cobalto/MF3

Cobalto/MFD3

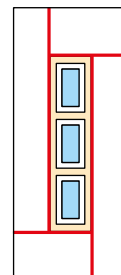
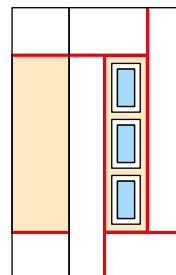

**COBALTO/F3**

Colore: RAL 7038 Grinz  
Vetro: decoro GS (40)  
Maniglia: A 944



**COBALTO/H3**

Colore: RAL 7038 Grinz  
Cornici vetro: RAL 7016 Grinz\*  
Vetro: decoro GC (40)  
Maniglia: A 944 N



\* Soluzione su richiesta

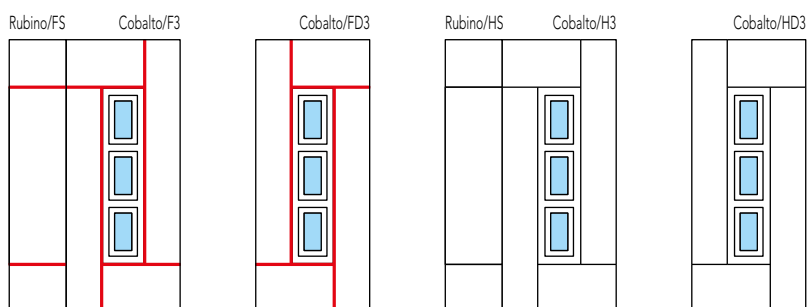



**COBALTO/MFD**

Colore Base: RAL 5003 Grinz  
2° Colore: Porpora AK39V Grinz  
Maniglia: A 952 X (Porpora AK39V Grinz)  
con illuminazione a led

**COBALTO/MF**

Colore Base: RAL 5003 Grinz  
2° Colore: Porpora AK39V Grinz  
Maniglia: A 952 X (Porpora AK39V Grinz)  
con illuminazione a led

**COBALTO/F**

Colore: RAL 5003 Grinz  
Maniglia: A 942 X (Porpora AK39V Grinz)



**COBALTO/H**

Colore: RAL 5003 Grinz  
Maniglia: A 942 X (Porpora AK39V Grinz)



INFINITY

STYLE

**A FILO**

EMOTION

NOVECENTO

INCYSO

VETRI E DECORI

MANIGLIE

PENSILINE

COLORI

SEZ. TECNICA

Rubino/MFS Cobalto/MF

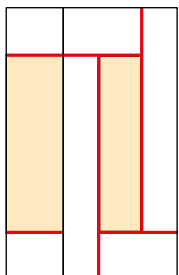

Cobalto/MFD

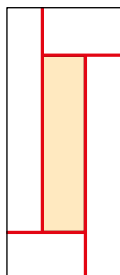

Rubino/FS Cobalto/F

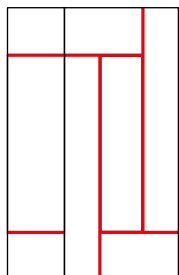

Cobalto/FD

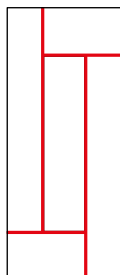

Rubino/HS Cobalto/H

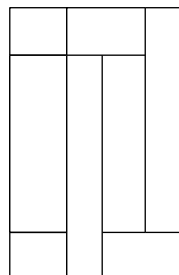

Cobalto/HD

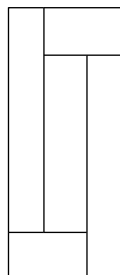

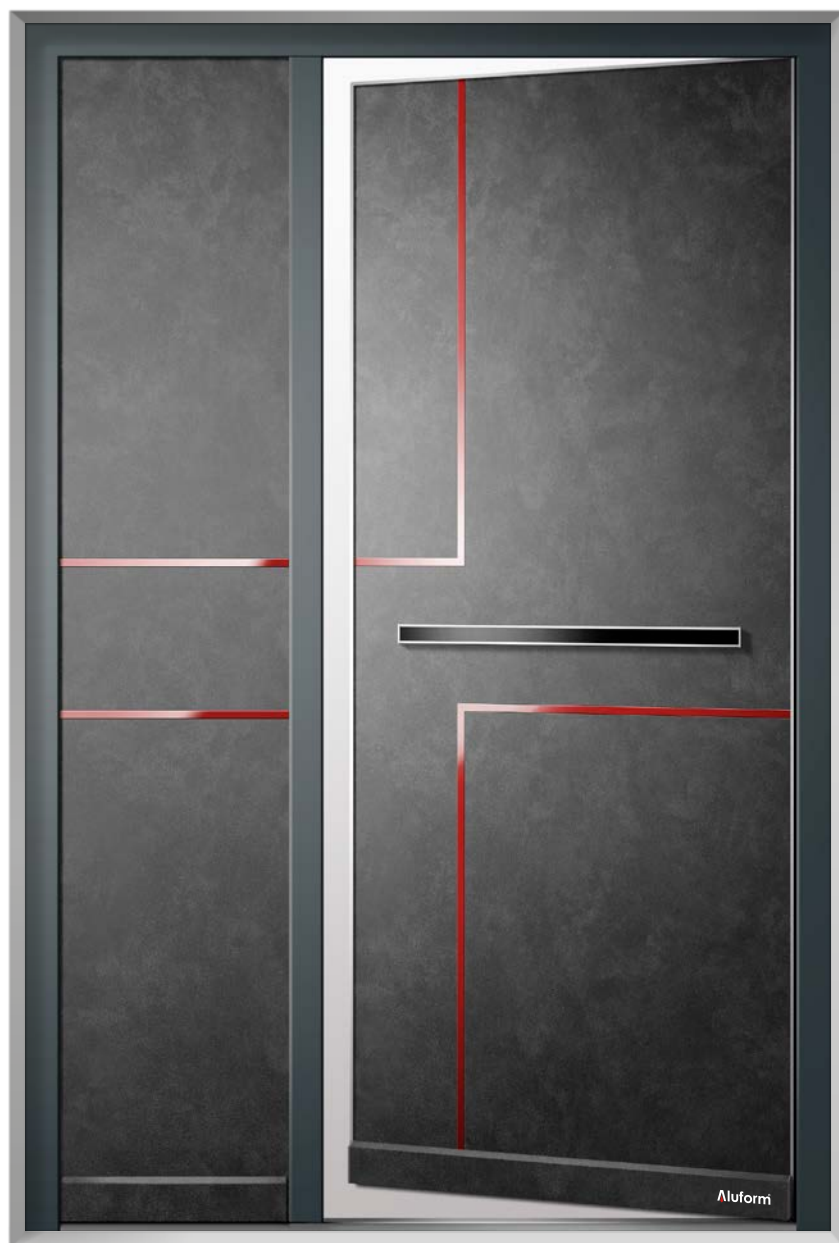

**QUARZO/FCS**

Colore: Ghisa RP102M  
Inseriti: RAL 3003 Lucido\*

**GIADA/F**

Colore: Ghisa RP102M  
Inseriti: RAL 3003 Lucido\*  
Maniglia: A 952 N



**GIADA/F**

Colore: Corten RP101M  
Maniglia: A 941



**GIADA/H**

Colore: RAL 7006 Grinz  
Maniglia: A 942



INFINITY

STYLE

**A FILO**

EMOTION

NOVECENTO

INCYSO

VETRI E DECORI

MANIGLIE

PENSILINE

COLORI

SEZ. TECNICA

\* Soluzione su richiesta

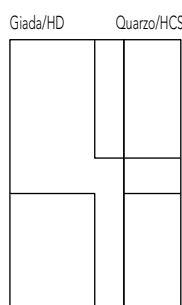
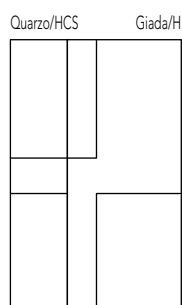
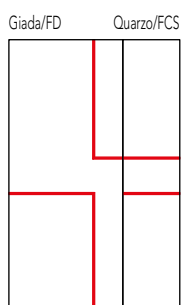
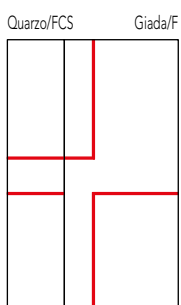



**CORALLO/MFS**

Colore Base: RAL 9005 Lucido  
2° Colore: Cemento RP103M

**CORALLO/MF**

Colore Base: RAL 9005 Lucido  
2° Colore: Cemento RP103M  
Maniglia: A 971 N con illuminazione a led

**CORALLO/MF**

Colore Base: RAL 7035 Grinz  
2° Colore: RAL 7030 Lucido  
Inserti: RAL 7035 Lucido\*  
Maniglia: A 961 N



**CORALLO/F**

Colore: RAL 7035 Grinz  
Inserti: RAL 7030 Lucido\*  
Maniglia: A 971 X (RAL 7035 Grinz)



**CORALLO/H**

Colore: RAL 7035 Grinz  
Maniglia: A 951 R



\* Soluzione su richiesta

Corallo/MFS Corallo/MF

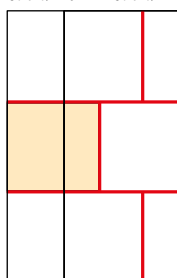

Corallo/FS Corallo/F

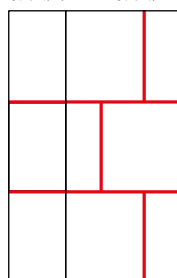

Corallo/HS Corallo/H

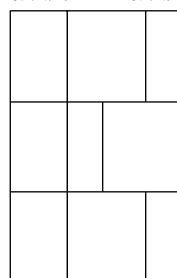



**RUBINO/MF**

Colore Base: Rovere grigio RP10L

2° Colore: Antracite P016V Grinz

Inserti: RAL 3003 Lucido\*

Maniglia: A 972 R



Rubino/MFS

Rubino/MF

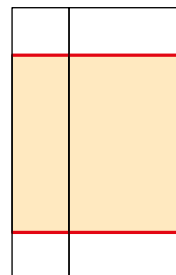

Jolly/WG1

Rubino/MF

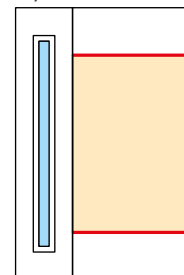

**RUBINO/F**

Colore: Rovere grigio RP10L  
Maniglia: A 941



**RUBINO/H**

Colore: Rovere grigio RP10L  
Maniglia: A 941 N



INFINITY

STYLE

**A FILO**

EMOTION

NOVECENTO

INCYSO

VETRI E DECORI

MANIGLIE

PENSILINE

COLORI

SEZ. TECNICA

\* Soluzione su richiesta

Rubino/FS	Rubino/F	Rubino/HS	Rubino/H	Rubino/MHS	Rubino/MH



**RUBINO/MFS**

Colore Base: RAL 5014 Grinz  
2° Colore: RAL 5003 Lucido

**RUBINO/MF1**

Colore Base: RAL 5014 Grinz  
2° Colore: RAL 5003 Lucido  
Cornici vetro: RAL 5003 Lucido\*  
Vetro: rifle (77)  
Maniglia: A 703

**RUBINO/F1**

Colore: RAL 5014 Grinz  
Cornice vetro: alluminio effetto inox\*  
Vetro: decoro EG (77)  
Maniglia: A 700



**RUBINO/H1**

Colore: RAL 5014 Grinz  
Cornice vetro: RAL 5003 Grinz\*  
Vetro: decoro BL (77)  
Maniglia: A 700



INFINITY

STYLE

**A FILO**

EMOTION

NOVECENTO

INCYSO

VETRI E DECORI

MANIGLIE

PENSILINE

COLORI

SEZ. TECNICA

\* Soluzione su richiesta

Rubino/MFS Rubino/MF1

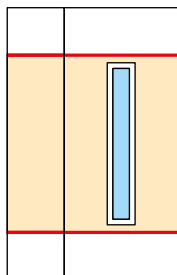

Rubino/MFS1 Rubino/MF1

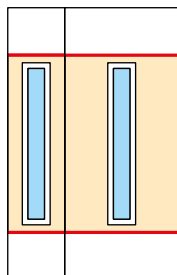

Rubino/MHS1 Rubino/MH1

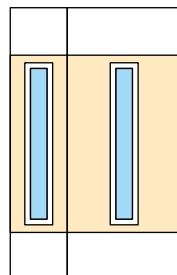

Rubino/FS1 Rubino/F1

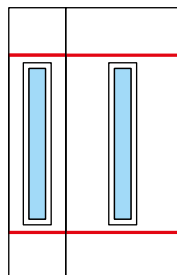

Rubino/HS1 Rubino/H1

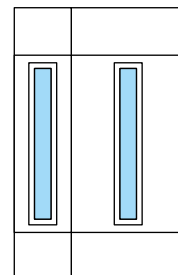



**RUBINO/MFGS**

Colore Base: Ghisa RP102M  
2° Colore: RAL 9005 Grinz  
Inserti: RAL 9005 Lucido\*

**RUBINO/MFG**

Colore Base: Ghisa RP102M  
2° Colore: RAL 9005 Grinz  
Inserti: RAL 9005 Lucido\*  
Maniglia: A 961 X (Ghisa RP102M)



**RUBINO/MFG**

Colore Base: Bleu AK15V Grinz  
2° Colore: Porpora AK39V Grinz  
Maniglia: A 942 X (Porpora AK39V Grinz)



**RUBINO/FG**

Colore Base: Rovere G. RP10L  
Inserti: RAL 3005 Lucido\*  
Maniglia: A 941 X (RAL 3005 Grinz)



**RUBINO/HG**

Colore: Noce RP08L  
Maniglia: A 961 N



\* Soluzione su richiesta

Rubino/MFGS    Rubino/MFG

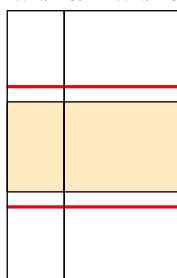

Rubino/FGS    Rubino/FG



Rubino/HGS    Rubino/HG

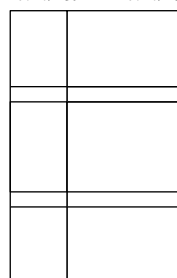

Jolly/WG1    Rubino/HG

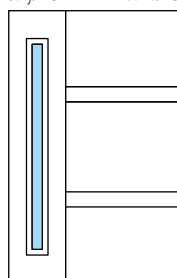



**TOPAZIO/MHBS**

Colore Base: RAL 7032 Grinz  
2° Colore: RAL 7030 Lucido

**TOPAZIO/MHB**

Colore Base: RAL 7032 Grinz  
2° Colore: RAL 7030 Lucido  
Maniglia: A 962 N  
con illuminazione a led

**TOPAZIO/MFB**

Colore Base: Corten RP101M  
2° Colore: RAL 8019 Grinz  
Maniglia: A 942



**TOPAZIO/MHE**

Colore Base: Cemento RP103M  
2° Colore: Ghisa RP102M  
Maniglia: A 941 N



**TOPAZIO/MFE**

Colore Base: Cemento RP103M  
2° Colore: Ghisa RP102M  
Maniglia: A 941



Topazio/MHBS Topazio/MHB

Topazio/MFBS Topazio/MFB

Topazio/MHES Topazio/MHE

Topazio/MFES Topazio/MFE

**A FILO**  
COLLECTION

**TOPAZIO/MHC**

Colore Base: RAL 7035 Grinz  
2° Colore: RAL 6009 Lucido  
Maniglia: A 943 X (RAL 7035 Grinz)



**TOPAZIO/MFC**

Colore Base: RAL 7035 Grinz  
2° Colore: RAL 6009 Grinz  
Maniglia: A 943 X (RAL 6009 Grinz)



**TOPAZIO/HD**

Colore: Avorio AK16V Grinz  
Maniglia: A 683



Topazio/MHCS Topazio/MHC



Topazio/MFCS Topazio/MFC

Jolly/WG1 Topazio/MFC

Topazio/HDS Topazio/HD

**TOPAZIO/FD**

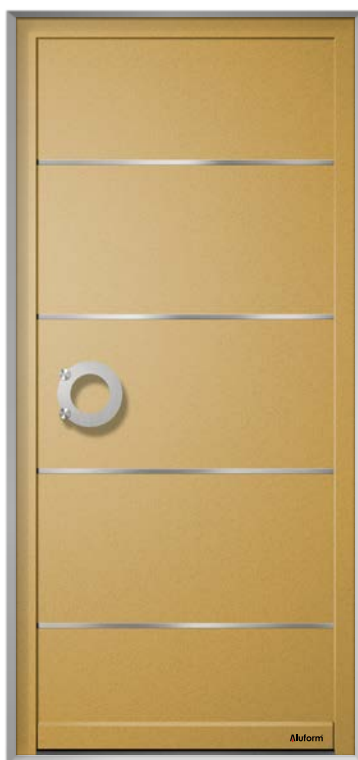
Colore: Ambra AK40V Grinz  
Maniglia: A 685



**TOPAZIO/HD3**

Colore: RAL 6021 Grinz  
Vetro: decoro GC (40)  
Maniglia: A 686



**TOPAZIO/FD3**

Colore: Salvia AK11V Grinz Mix  
Vetro: decoro FN (40)  
Maniglia: A 687



Topazio/FDS	Topazio/FD

Topazio/HDS3	Topazio/HD3

Topazio/FDS3	Topazio/FD3



**QUARZO/MHCS**

Colore Base: RAL 9005 Lucido  
2° colore: Rovere grigio RP10L

**QUARZO/MHC**

Colore Base: Rovere grigio RP10L  
2° colore: RAL 9005 Lucido  
Maniglia: A 941 R

**QUARZO/MFC**

Colore Base: RAL 7038 Grinz  
2° Colore: RAL 6009 Lucido  
Maniglia: A 945



**QUARZO/FC**

Colore: RAL 7038 Grinz  
Inserti: RAL 6009 Grinz\*  
Maniglia: A 945 X (RAL 7038 Grinz)



**QUARZO/HC**

Colore: RAL 7038 Grinz  
Maniglia: A 945 X (RAL 6009 Grinz)



\* Soluzione su richiesta

Quarzo/MHCS    Quarzo/MHC

Quarzo/MFCS    Quarzo/MFC

Quarzo/FCS    Quarzo/FC

Quarzo/HCS    Quarzo/HC





**QUARZO/MFD**

Colore Base: Rovere grigio RP10L  
2° Colore: RAL 9007 Grinz  
Maniglia: A 952



**QUARZO/FD**

Colore: Ciliegio RP02L  
Inserti: RAL 9005 Lucido\*  
Maniglia: A 952 N



INFINITY

STYLE

**A FILO**

EMOTION

NOVECENTO

INCYSO

VETRI E DECORI

MANIGLIE

PENSILINE

COLORI

SEZ. TECNICA

\* Soluzione su richiesta

Quarzo/MFDS    Quarzo/MFD

Quarzo/FDS    Quarzo/FD



**RUBINO/MHS1**

Colore Base: RAL 7030 Grinz  
2° Colore: RAL 7016 Grinz  
Vetro: decoro GS (77)

**QUARZO/MHE**

Colore Base: RAL 7030 Grinz  
2° Colore: RAL 7016 Grinz  
Maniglia: A 972 X (RAL 7016 Grinz)  
con illuminazione led

**QUARZO/HE**

Colore: RAL 7016 Grinz  
Maniglia: A 962 N



**QUARZO/FE**

Colore: RAL 7005 Grinz  
Maniglia: A 962



**QUARZO/MFE**

Colore: Orange AK38V Grinz  
2° Colore: RAL 7005 Grinz  
Maniglia: A 942



Rubino/MHS1 Quarzo/MHE

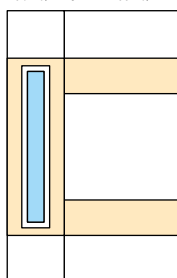

Quarzo/MHES



Quarzo/HES Quarzo/HE

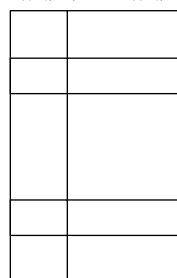

Quarzo/FES Quarzo/FE



Quarzo/MFES Quarzo/MFE

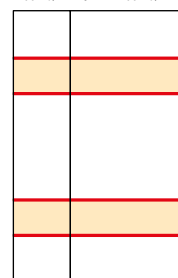

**A FILO**  
COLLECTION

**QUARZO/HF**

Colore: Abete bianco RP14L  
Maniglia: A 941



**QUARZO/FF**

Colore: Abete bianco RP14L  
Inserti: RAL 9005 Lucido\*  
Maniglia: A 955 N



Quarzo/HFS    Quarzo/HF

Quarzo/FFS    Quarzo/FF

**QUARZO/HF5**

Colore: RAL 7015 Grinz  
Vetro: rifle (40)  
Maniglia: A 952 X (RAL 7015 Grinz)



**QUARZO/FF5**

Colore: RAL 7015 Grinz  
Vetro: satinato A (40)  
Maniglia: A 952



INFINITY

STYLE

**A FILO**

EMOTION

NOVECENTO

INCYSO

VETRI E DECORI

MANIGLIE

PENSILINE

COLORI

SEZ. TECNICA

\* Soluzione su richiesta

Quarzo/HFS    Quarzo/HF5

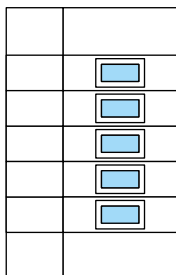

Quarzo/FFS    Quarzo/FF5





Aluformi

**QUARZO/MHGS**

Colore Base: Cemento RP103M  
2° Colore: RAL 7016 Grinz

**QUARZO/MHG3**

Colore Base: Cemento RP103M  
2° Colore: RAL 7016 Grinz  
Cornici vetro: RAL 7016 Grinz\*  
Vetro: satinato A (39)  
Maniglia: A 945 N

**QUARZO/MHG**

Colore Base: RAL 8014 Grinz  
2° Colore: RAL 6021 Lucido  
Maniglia: A 942 X (RAL 8014 Grinz)



**QUARZO/MFG**

Colore Base: RAL 8014 Grinz  
2° Colore: RAL 6021 Lucido  
Maniglia: A 942 X (RAL 8014 Grinz)



INFINITY

STYLE

**A FILO**

EMOTION

NOVECENTO

INCYSO

VETRI E DECORI

MANIGLIE

PENSILINE

COLORI

SEZ. TECNICA

\* Soluzione su richiesta

Quarzo/MHGS Quarzo/MHG3

	□ □ □

Quarzo/MHGS Quarzo/MHG

Quarzo/MFGS Quarzo/MFG

Jolly/WG1 Quarzo/MFG

**A FILO**  
COLLECTION

**QUARZO/MHF**

Colore Base: RAL 6009 Grinz  
2° Colore: RAL 9005 Lucido  
Maniglia: A 962 R



**QUARZO/MFF**

Colore Base: RAL 6009 Grinz  
2° Colore: RAL 9005 Lucido  
Maniglia: A 962 R

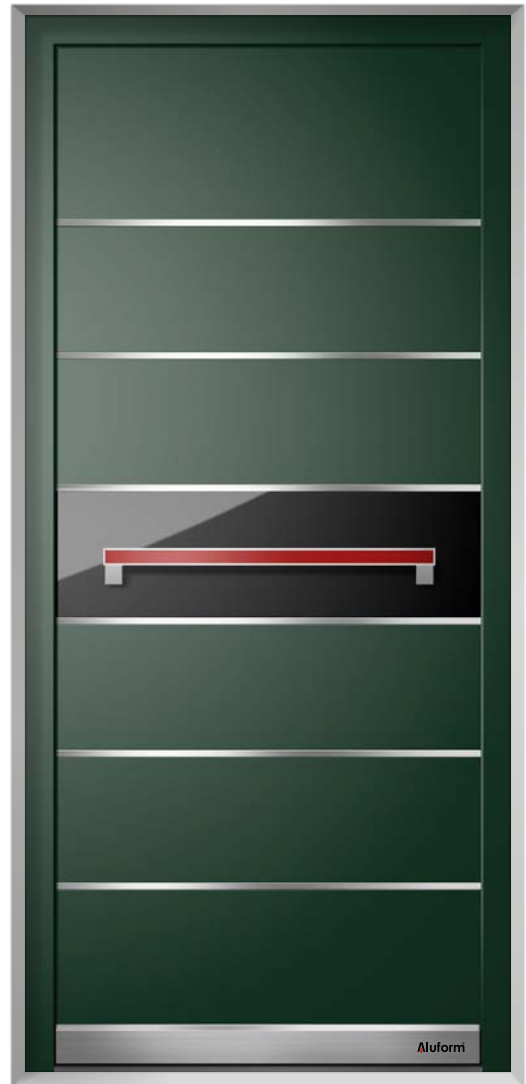

Quarzo/MHFS Quarzo/MHF

Quarzo/MFFS Quarzo/MFF

Tablet/YS Quarzo/MFF



**QUARZO/MHL**

Colore Base: RAL 7035 Grinz  
2° Colore: Bleu AK15V Grinz  
Maniglia: A 944 X (Bleu AK15V Grinz)



**QUARZO/MFL**

Colore Base: RAL 7035 Grinz  
2° Colore: Bleu AK15V Grinz  
Maniglia: A 944 X (Bleu AK15V Grinz)



INFINITY

STYLE

**A FILO**

EMOTION

NOVECENTO

INCYSO

VETRI E DECORI

MANIGLIE

PENSILINE

COLORI

SEZ. TECNICA

Quarzo/MHLS    Quarzo/MHL

Quarzo/MFLS    Quarzo/MFL

Jolly/WG1    Quarzo/MFL



**JOLLY/WG1**

Colore: RAL 9005 Lucido  
Vetro: decoro GC (31)

**SMERALDO/MH**

Colore Base: RAL 9005 Lucido  
2° Colore: Corten RP101M  
Maniglia: A 952 C

**SMERALDO/MH**

Colore Base: RAL 5003 Grinz  
2° Colore: RAL 9005 Lucido  
Maniglia: A 961 X (RAL 5003 Grinz)



**SMERALDO/H**

Colore: RAL 5003 Grinz  
Maniglia: A 944



INFINITY

STYLE

**A FILO**

EMOTION

NOVECENTO

INCYSO

VETRI E DECORI

MANIGLIE

PENSILINE

COLORI

SEZ. TECNICA

Jolly/WG1 Smeraldo/MH

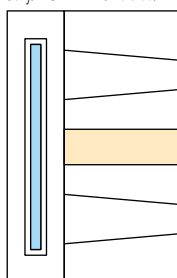

Quarzo/MHCS Smeraldo/MH

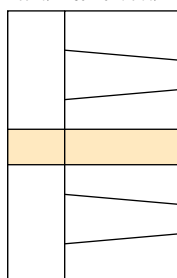

Tablet/YS Smeraldo/H

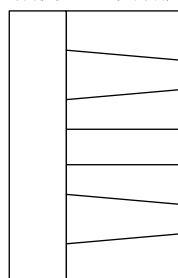

# KREO

SPAZIO ALLA FANTASIA

Geometria e creatività si fondono in uno stile elegante e minimale dettato dalla regolarità delle forme e dalla difformità dei volumi. La possibilità di personalizzare dimensioni e colori delle fasce e degli inserti, rende KREO unico ed esclusivo. Dai sfogo alla tua fantasia e ALUFORM realizzerà la porta d'ingresso più esclusiva: la tua!

## KREO/A

Fasce su misura e colori a scelta

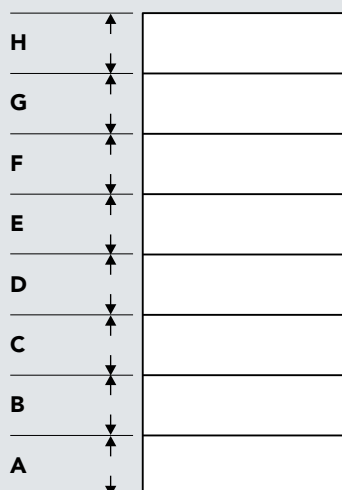

Modello realizzabile con un numero di fasce da due a otto, nelle misure fornite dal cliente e fino a quattro colori diversi a scelta delle fasce o degli inserti. Di serie, il lato interno del pannello sarà realizzato nello stesso colore indicato per la fascia **A**. Colori diversi su richiesta. Pannello da ordinare a misura finita con altezza delle fasce non inferiore a cm 6.

Nota: qualora si desideri un modello con fasce tutte della stessa misura, vedere anche i modelli Rigo.

## KREO/B

Fasce a misura fissa e colori a scelta

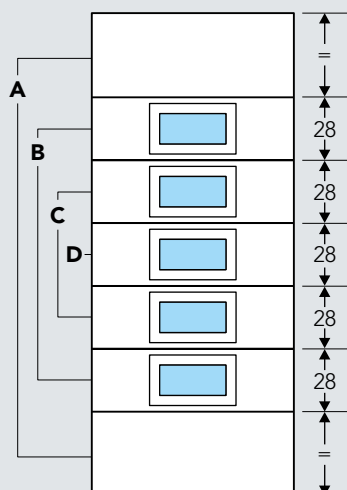

Modello realizzabile con tre o quattro colori diversi a scelta. Nella versione a vetri, le cornici seguono gli stessi colori della fascia in cui sono posizionate. Di serie, il lato interno del pannello sarà realizzato nello stesso colore indicato per le fasce **A**. Colori diversi su richiesta. Le fasce centrali sono di misura fissa di cm 28, quelle alle estremità sono invece uguali fra loro, ma di dimensione variabili in funzione dell'altezza del pannello.

Nota: qualora si desideri un modello simile in colore unico o bicolore, vedere anche i modelli Quarzo.

## KREO/A

FASCE SU MISURA  
E COLORI A SCELTA

## KREO/FA

Colore: RAL 5003 Grinz  
Maniglia: A942



Le immagini sopra raffigurano un esempio delle quattro varianti previste per il modello **KREO/A**: con e senza inserti, mono e multi colore. Le misure delle fasce di questi esempi sono: **B** cm 45, **C** cm 16, **D** cm 35, **E** cm 32, **F** cm 23, **G** cm 9. Le fasce **A** e **H** sono uguali fra loro, ma di dimensione variabili in funzione della differenza fra l'altezza del pannello e la somma delle altre fasce.

**KREO/MFA**

A,C,E,G,H: Colore RAL 5003 Grinz  
B,D,F: Colore Porpora AK39V Grinz  
Maniglia: A 941



**KREO/HA**

Colore: RAL 9007 Grinz  
Maniglia: A 962 X (RAL 8019 Grinz)



**KREO/MHA**

A,C,D,F,H: Colore RAL 9007 Grinz  
B,E,G: Colore RAL 8019 Lucido  
Maniglia: A 700



	Kreo/MFAS	Kreo/MFA
H		
G		
F		
E		
D		
C		
B		
A		

	Kreo/FAS	Kreo/FA
H		
G		
F		
E		
D		
C		
B		
A		

	Kreo/MHAS	Kreo/MHA
H		
G		
F		
E		
D		
C		
B		
A		

	Kreo/HAS	Kreo/HA
H		
G		
F		
E		
D		
C		
B		
A		

## KREO/B

FASCE A MISURA FISSA  
E COLORI A SCELTA

### KREO/MHB5

A: Colore RAL 5003 Grinz  
B: Colore RAL 5010 Grinz  
C: Colore RAL 5014 Grinz  
D: Colore RAL 7001 Grinz  
Vetro: rifle (40), cornici a colore  
Maniglia: A 961 X (RAL 5010 Grinz)



### KREO/MFB

A: Colore RAL 6009 Grinz  
B: Colore RAL 6005 Grinz  
C: Colore RAL 6021 Grinz  
D: Colore RAL 7038 Grinz  
Maniglia: A 952 X (RAL 6005 Grinz)



### KREO/MFB5

A: Colore RAL 8019  
B: Colore RAL 7006 Grinz  
C: Colore RAL 1019 Grinz  
D: Colore RAL 1013 Grinz  
Vetro: satin. D (40), cornici a colore  
Maniglia: A 945 X (RAL 1019 Grinz)

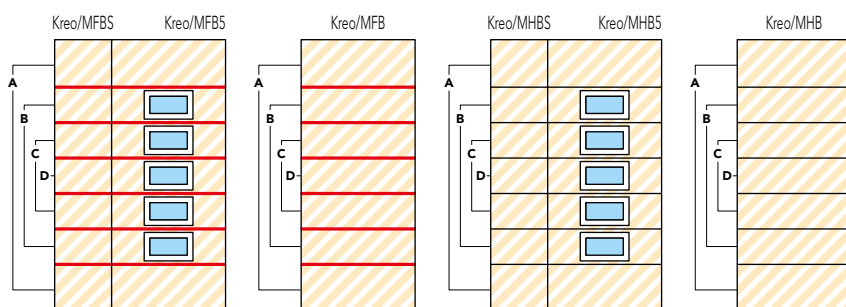

Le immagini sopra raffigurano un esempio delle quattro varianti previste per il modello **KREO/B**: con e senza inserti, con e senza vetri, realizzati in quattro colori diversi. Nella versione a vetri, le cornici seguono gli stessi colori della fascia in cui sono posizionate.



INFINITY

STYLE

A FILO

EMOTION

NOVECENTO

INCYSO

VETRI E DECORI

MANIGLIE

PENSILINE

COLORI

SEZ. TECNICA

**JOLLY/WG1**

Colore: RAL 7016 Grinz  
Cornice vetro: RAL 7030 Grinz\*  
Vetro: rifle (31)

\* Soluzione su richiesta

**KREO/MHB**

A: Colore RAL 7016 Grinz  
B: Colore RAL 7011 Grinz  
C: Colore RAL 7005 Grinz  
D: Colore RAL 7030 Grinz  
Maniglia: A 945 X (RAL 7005 Grinz)

# RIGO

## IL FASCINO DELLA SIMMETRIA

Spazi definiti ed ordinati, geometrie orizzontali costanti sempre in perfetto equilibrio. RIGO è perfezione ed armonia delle forme, simmetria allo stato puro!

**Rigo/B**  
2 spazi

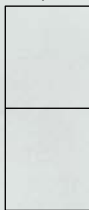

**Rigo/C**  
3 spazi

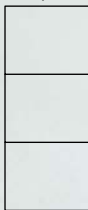

**Rigo/D**  
4 spazi



**Rigo/E**  
5 spazi

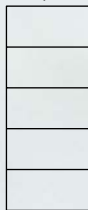

**Rigo/F**  
6 spazi

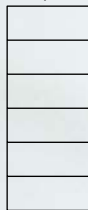

**Rigo/G**  
7 spazi



**Rigo/H**  
8 spazi



I modelli Rigo si caratterizzano per le dimensioni delle fasce sempre uguali fra loro, a prescindere dall'altezza del pannello. Se si desidera mantenere questa caratteristica, ordinare il pannello a misura finita.

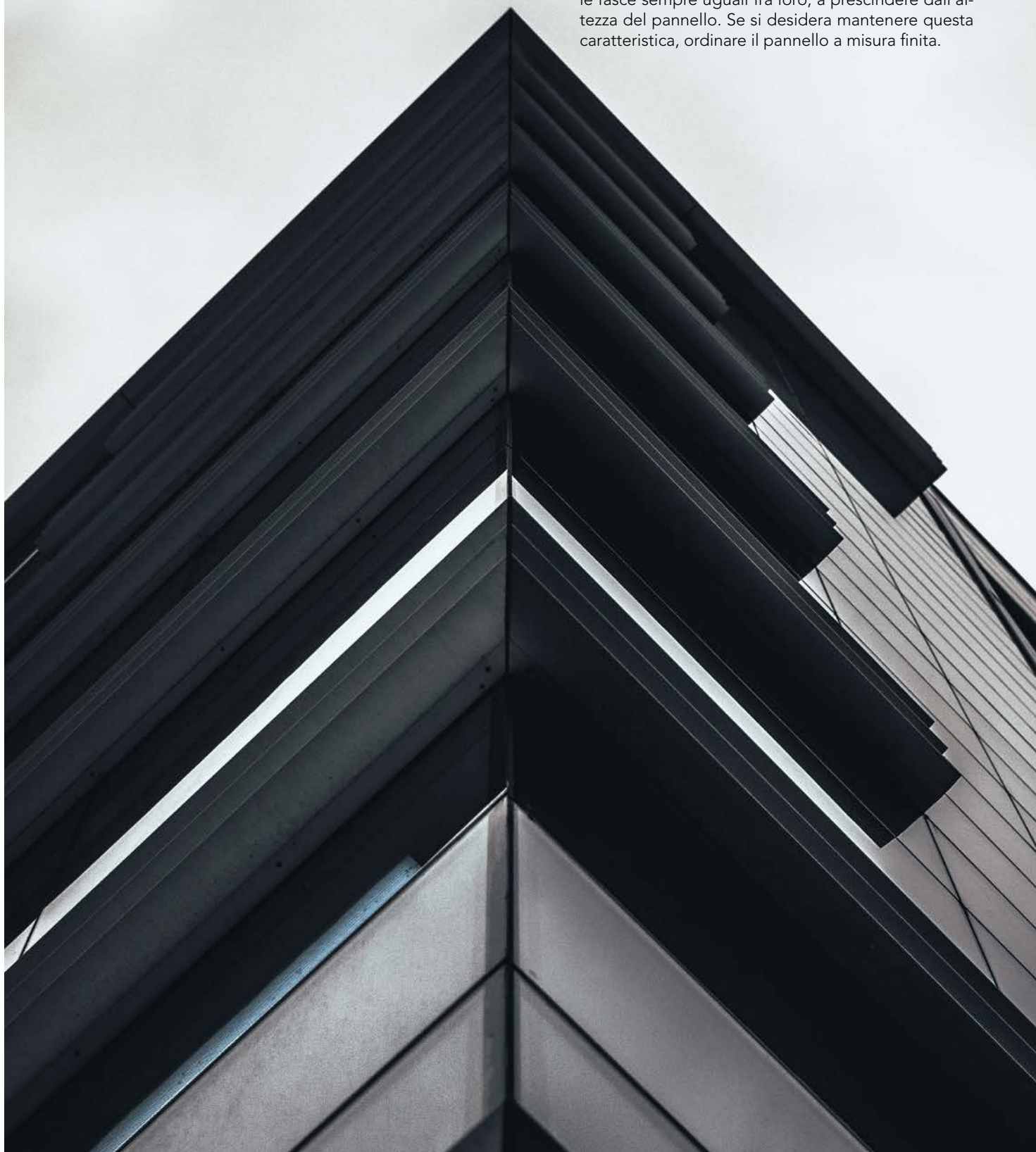



**RIGO/MFB**

Colore base: RAL 7035 Grinz  
2° Colore: RAL 7005 Grinz  
Maniglia: A 942



**RIGO/FB**

Colore: RAL 7035 Grinz  
Inserito: RAL 8019 Lucido\*  
Maniglia: A 941 X  
(RAL 8019 Grinz)



**RIGO/HB**

Colore: RAL 7035 Grinz  
Maniglia: A 941 X  
(RAL 8019 Grinz)



\* Soluzione su richiesta

Rigo/FBS      Rigo/FB

Rigo/MFBS      Rigo/MFB

Rigo/HBS      Rigo/HB

Rigo/MHBS      Rigo/MHB

Modello con **2 fasce** di dimensioni uguali fra loro.

**A FILO**  
COLLECTION

**RIGO/HC**

Colore: RAL 6005 Grinz  
Maniglia: A 944 X  
(RAL 6021 Grinz)



**RIGO/FC**

Colore: RAL 6021 Grinz  
Maniglia: A 944



**RIGO/MHC**

Colore: RAL 6021 Grinz  
2° Colore: RAL 6009 Grinz  
Maniglia: A 944 X (RAL 6021 Grinz)



Rigo/HCS Rigo/HC

Rigo/FCS Rigo/FC

Rigo/MHCS Rigo/MHC

Rigo/MFCS Rigo/MFC

Modello con **3 fasce** di dimensioni uguali fra loro. Se si desidera mantenere questa caratteristica, ordinare il pannello a misura finita.

**RIGO/HD**

Colore: RAL 5010 Grinz  
Maniglia: A 624



**RIGO/FD**

Colore: RAL 5014 Grinz  
Inseri: RAL 5003 Lucido\*  
Maniglia: A 700



**RIGO/MFD**

Colore: RAL 5014 Grinz  
2° Colore: RAL 5003 Grinz  
Maniglia: A 705



\* Soluzione su richiesta

Rigo/HDS	Rigo/HD

Rigo/FDS	Rigo/FD

Rigo/MHDS	Rigo/MHD

Rigo/MFDS	Rigo/MFD

Modello con **4 fasce** di dimensioni uguali fra loro. Se si desidera mantenere questa caratteristica, ordinare il pannello a misura finita.



**RIGO/FES**

Colore: RAL 7032 Grinz  
Inserti: RAL 8019 Grinz\*

**RIGO/FE**

Colore: RAL 7032 Grinz  
Inserti: RAL 8019 Grinz\*  
Maniglia: A 943 X (RAL 8019 Grinz)

**RIGO/MFE**

Colore: RAL 7032 Grinz  
2° Colore: RAL 8019 Grinz  
Maniglia: A 943 X  
(RAL 7032 Grinz)



**RIGO/MHE**

Colore: RAL 7032 Grinz  
2° Colore: RAL 8019 Grinz  
Maniglia: A 943 X  
(RAL 8019 Grinz)



**RIGO/HE**

Colore: Corten RP101M  
Maniglia: A 943 X  
(RAL 7032 Grinz)



\* Soluzione su richiesta

Rigo/FES      Rigo/FE

Rigo/MHES      Rigo/MHE

Rigo/HES      Rigo/HE

Rigo/MFES      Rigo/MFE

Modello con **5 fasce** di dimensioni uguali fra loro. Se si desidera mantenere questa caratteristica, ordinare il pannello a misura finita.

**A FILO**  
COLLECTION

**RIGO/HF**

Colore: RAL 3005 Grinz  
Maniglia: A 961 X  
(RAL 3005 Grinz)



**RIGO/FF**

Colore: Cemento RP103M  
Maniglia: A 962



**RIGO/MHF**

Colore: Cemento RP103M  
2° Colore: RAL 3005 Grinz  
Maniglia: A 962 X (RAL 3005 Grinz)



Rigo/HFS Rigo/HF

Rigo/FFS Rigo/FF

Rigo/MHFS Rigo/MHF

Rigo/MFFS Rigo/MFF

Modello con **6 fasce** di dimensioni uguali fra loro. Se si desidera mantenere questa caratteristica, ordinare il pannello a misura finita.

**RIGO/HG**

Colore: RAL 7030 Grinz  
Maniglia: A 962 X  
(RAL 8019 Grinz)



**RIGO/FG**

Colore: Abete bianco RP14L  
Inseri: RAL 7030 Lucido\*  
Maniglia: A 952



**RIGO/MFG**

Colore: Abete bianco RP14L  
2° Colore: RAL 7030 Grinz  
Maniglia: A 952 X (RAL 7030 Grinz)



\* Soluzione su richiesta

Rigo/HGS Rigo/HG

Rigo/FGS Rigo/FG

Rigo/MHGS Rigo/MHG

Rigo/MFGS Rigo/MFG

Modello con **7 fasce** di dimensioni uguali fra loro. Se si desidera mantenere questa caratteristica, ordinare il pannello a misura finita.





**RIGO/MFH**

Colore base: Ghisa RP102M  
2° Colore: Rovere grigio RP10L  
Maniglia: A 963 N



**RIGO/HH**

Colore: Ghisa RP102M  
Maniglia: A 941



**RIGO/MHH**

Colore: Rovere grigio RP10L  
2° Colore: Ghisa RP102M  
Maniglia: A 963 N



Rigo/MFHS	Rigo/MFH

Rigo/HHS	Rigo/HH

Rigo/MHHS	Rigo/MHH

Modello con **8 fasce** di dimensioni uguali fra loro. Se si desidera mantenere questa caratteristica, ordinare il pannello a misura finita.

# CARATTERISTICHE TECNICHE

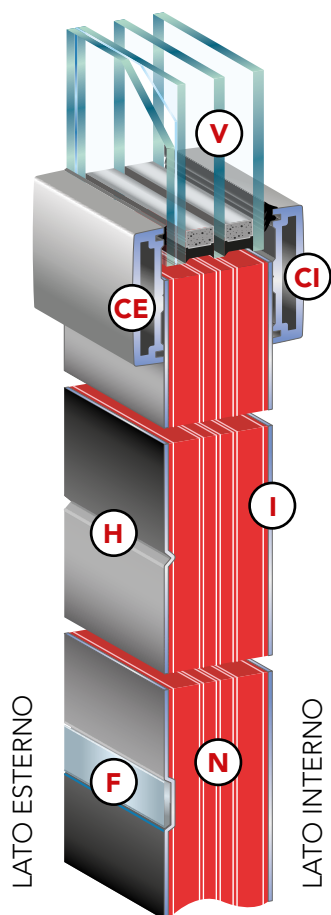

**CE - Cornice lato esterno** realizzata in alluminio estruso dello stesso colore del pannello. Su richiesta, anche di colore diverso, compresa la finitura effetto inox. Per le finiture effetto legno, vedi limitazioni alla pagina successiva.

**CI - Cornice lato interno** stesse caratteristiche e possibilità di personalizzazione della cornice sul lato esterno, può essere smontata e rimontata facilmente, per l'installazione e la sostituzione del vetro.

**F - Lavorazione decorativa** di mm 17 x 2 di profondità, ricavata sulla lastra di alluminio, nella quale è incastonato l'inserto in alluminio nella finitura di serie effetto inox. Su richiesta, finitura nei colori della serie Lac ed Exclusive.

**H - Lavorazione decorativa** con bisellatura di mm 6 x 3 di profondità, ricavata sulla lastra di alluminio.

**I - Lato interno liscio** realizzato di serie dello stesso colore del lato esterno (o colore base per i modelli bicolore). Su richiesta, colori diversi e varianti decorative come indicate sotto.

**N - Nucleo** costituito da un mix di materiali particolarmente performanti, disposti in più strati, con ottime proprietà di isolamento termico ed abbattimento acustico. Materiali e prestazioni variano in base alla tipologia e allo spessore del pannello.

**V - Vetro isolante** fornito su richiesta, realizzato con doppio o triplo vetro in base allo spessore del pannello. In entrambe le soluzioni, il vetro esterno è stratificato e quello interno temprato, in conformità alle vigenti norme sulla sicurezza. Per consentire il fissaggio della cornice interna, lo spessore del vetro deve essere inferiore di almeno 4 mm rispetto a quello del pannello.

**LATO ESTERNO**

**Esempio**

**LATO**

**INTERNO (di serie)**

**Liscio**  
Monocolore

**VARIANTI**

**DECORATIVE LATO INTERNO (su richiesta)**

**Light**  
Monocolore, con lavorazione **H e F** senza inserti\*

**Double**  
Uguale al lato esterno



\* Per i modelli monocolore e senza inserti sul lato esterno, le varianti Light e Double coincidono. La lavorazione **H** o **F** senza l'inserto, riproduce sempre lo stesso disegno del modello esterno.

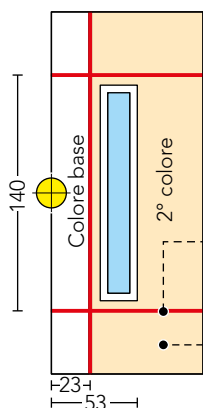

### DISEGNI E SIMBOLI

I disegni dei pannelli sono proporzionati alle dimensioni di cm 90 x 215 per l'anta principale e cm 45 x 215 per la mezza anta. Le quote indicate nei disegni (esprese in centimetri) indicano l'ingombro dell'area decorativa del modello. Con il termine area decorativa, si intende la parte lavorata del pannello che ne caratterizza il modello. L'area decorativa ha misure fisse e la sua posizione, rispetto al perimetro del pannello, può essere centrata o vincolata ad uno o più lati, quindi ad un angolo. I punti di vincolo sono indicati nei disegni con questo simbolo ● (vedi figure in basso).

**Inserti.** I modelli con gli inserti sono indicati da linee rosse nei rispettivi disegni.

**Modelli bicolore.** I modelli realizzabili in finiture bicolore sono indicati nei rispettivi disegni con la parte evidenziata in colore giallo. Essa rappresenta la porzione del pannello che verrà realizzata nel 2° colore indicato nel modulo ordine. Tutto il resto del pannello, compreso il suo lato interno e le eventuali cornici del vetro, sarà realizzato di serie nel colore base.

### DIMENSIONI E SPESSORI

I pannelli sono disponibili nelle dimensioni e negli spessori indicati nell'apposito capitolo tecnico. Nella scelta del modello, valutare che l'ingombro dell'area decorativa non interferisca con il profilo perimetrale in cui è alloggiato il pannello. Il margine consigliato per garantire un buon risultato estetico, è di almeno un centimetro lungo tutto il perimetro del pannello, al netto della presa dello stesso all'interno del profilo.

**Taglio a misura.** Il taglio a misura del pannello viene eseguito su richiesta, rispettando i vincoli dell'area decorativa del modello come sopra descritti ed indicati nelle figure in basso. Per esigenze particolari, ma nei limiti consentiti dall'area decorativa e dalle dimensioni richieste, il taglio a misura può essere effettuato decentrato. L'eventuale fattibilità va richiesta tramite l'invio di un disegno quotato del modello.

### LIMITAZIONI

**Spessori.** I modelli di questa collezione nella tipologia Kover **KR 7**, per rivestimento di porte blindate, sono realizzabili fino allo spessore minimo di 6 millimetri.

**Verso delle venature.** Tutti i colori effetto legno, avranno le venature disposte in senso verticale rispetto al pannello.

**Pannelli nei colori legno fuori cartella.** Saranno realizzati su richiesta presso impianti esterni. Per esigenze produttive, i pannelli con queste finiture avranno dei fori lungo i bordi verticali che ne riducono la misura utile in larghezza di circa 4 cm.

**Cornici vetro nei colori effetto legno.** I modelli a vetri di questa collezione, realizzati nei colori effetto legno della serie Skin e Effect (compresi i rispettivi fuori cartella), saranno realizzati di serie con le cornici di forma classica (foto a fianco).

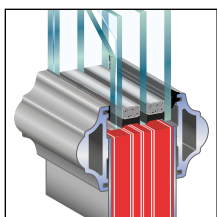

Fig. 1  
area decorativa  
centrata

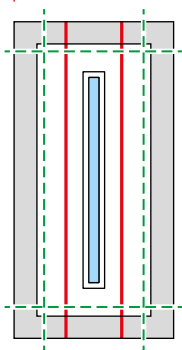

Fig. 2  
area decorativa  
vincolata in basso

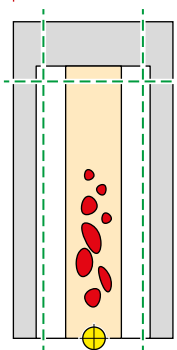

Fig. 3  
area decorativa  
vincolata ai lati

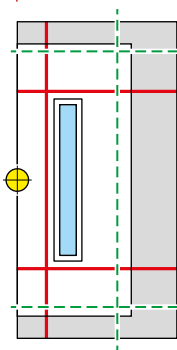
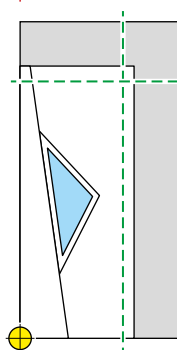
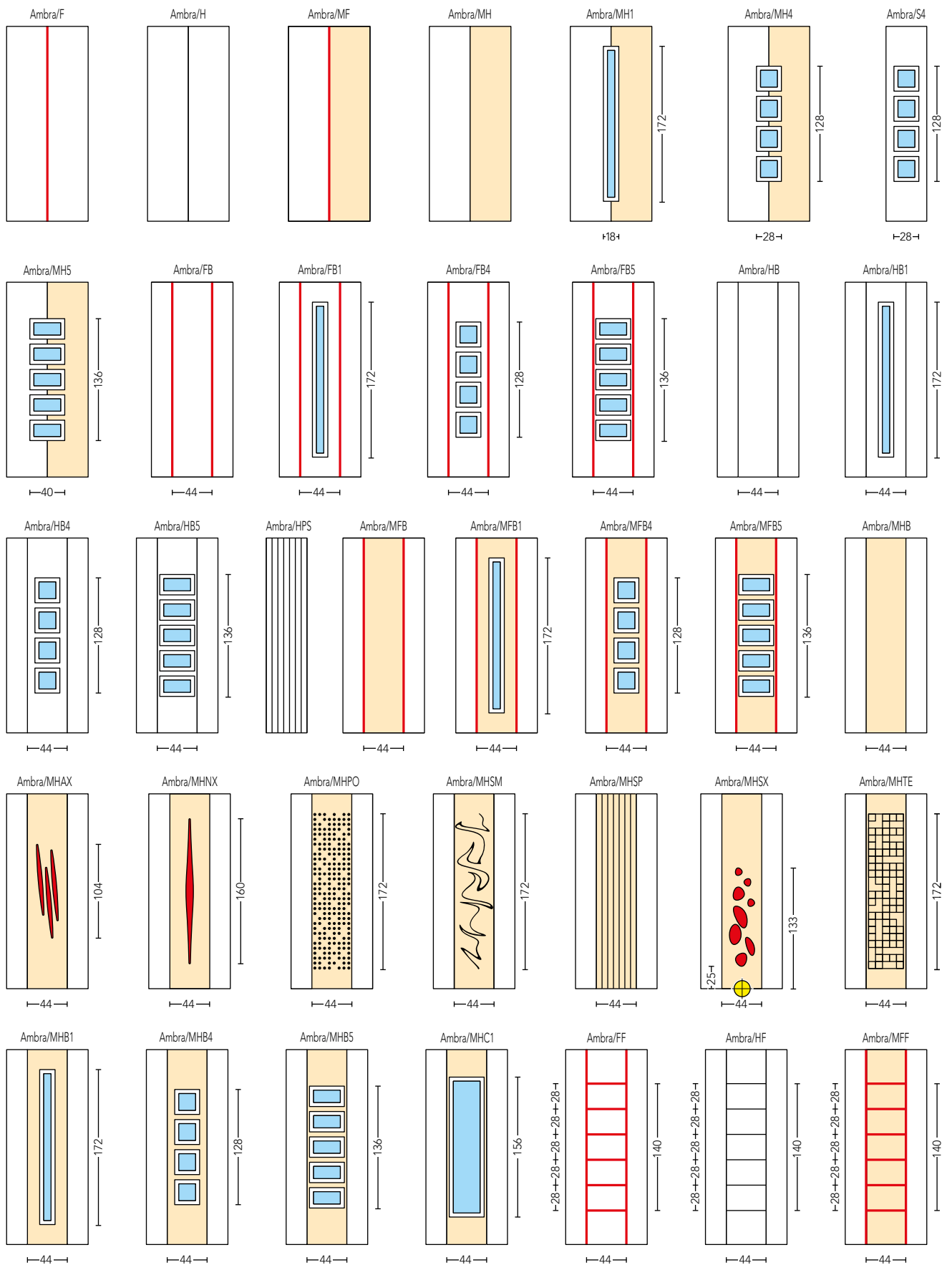
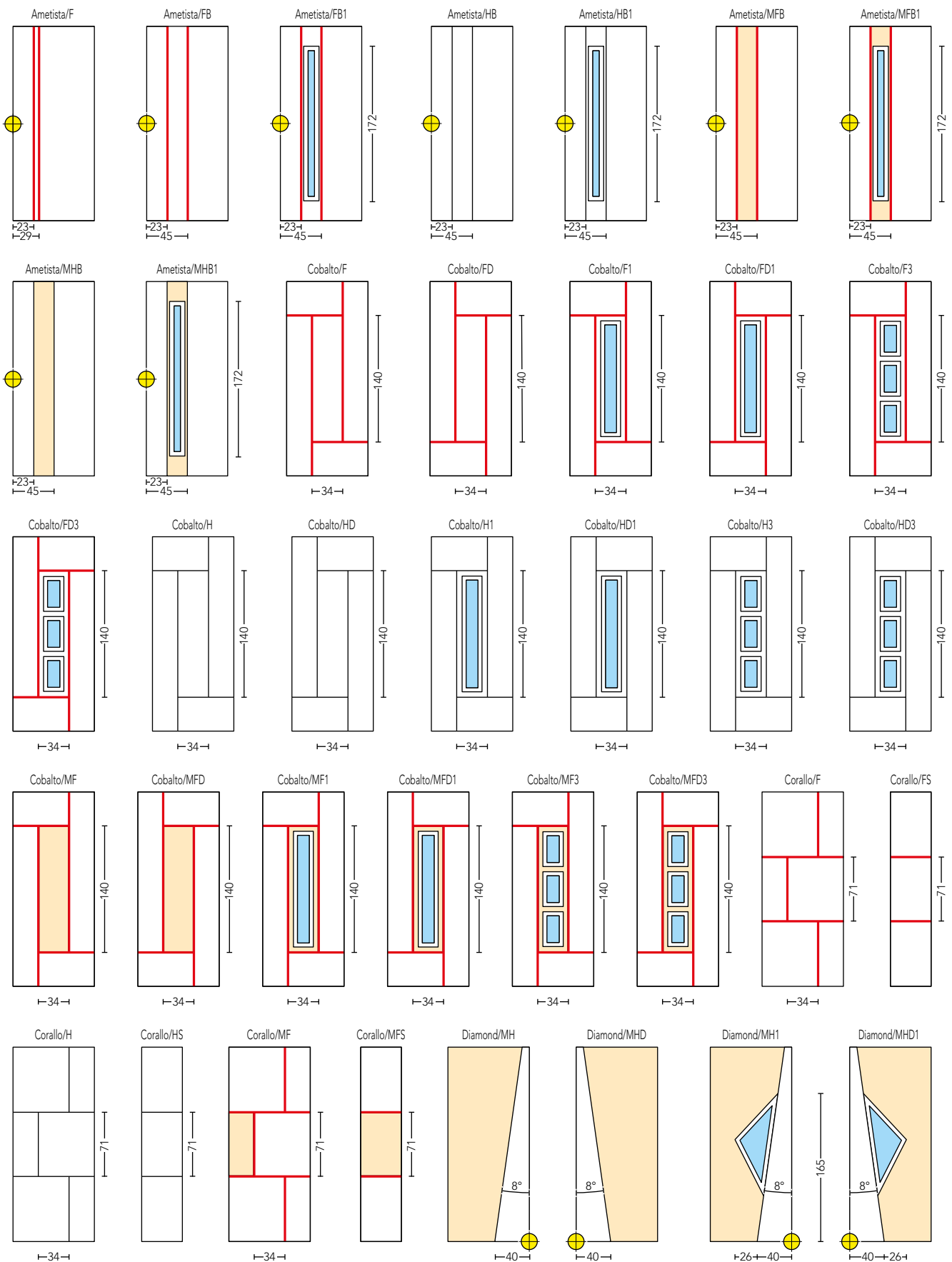

Fig. 4  
area decorativa  
vincolata agli angoli



# DISEGNI





# DISEGNI

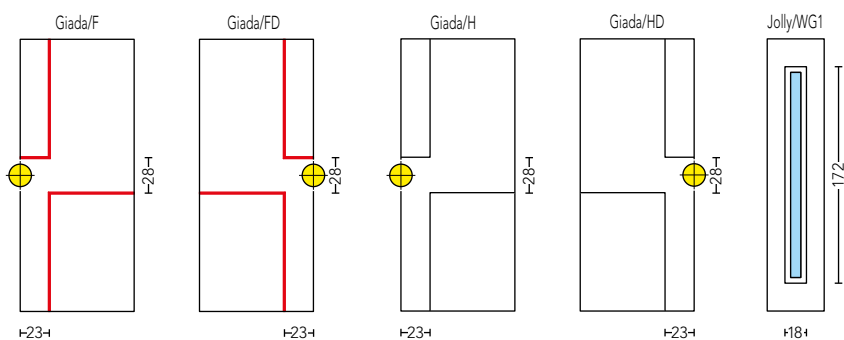

**KREO/A**  
Fasce su misura  
e colori a scelta

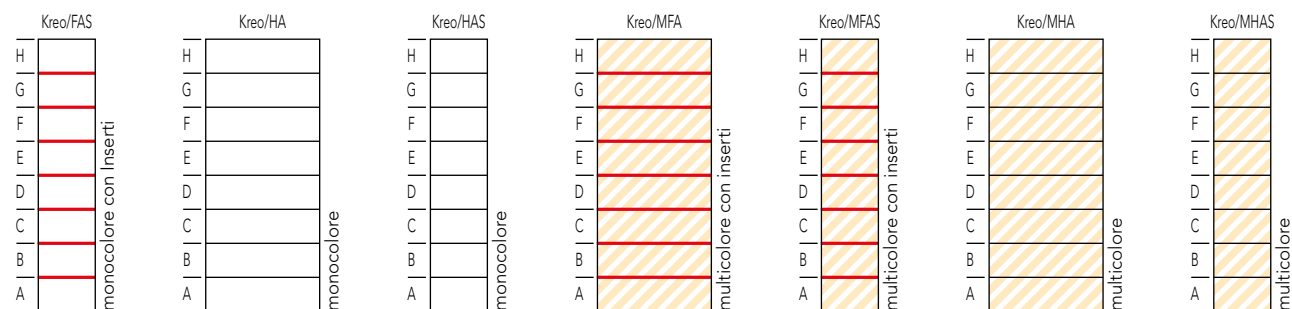
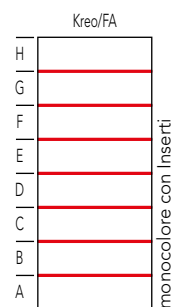

## KREO/B

Fasce a misura fissa  
e colori a scelta

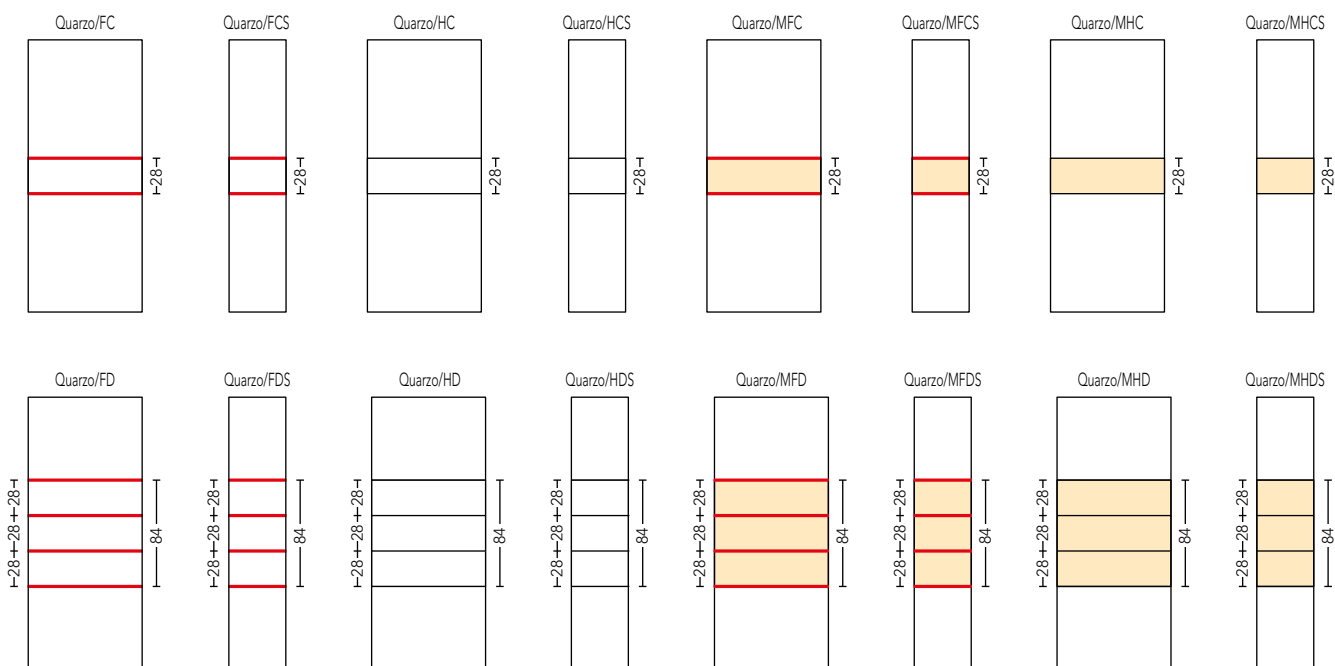
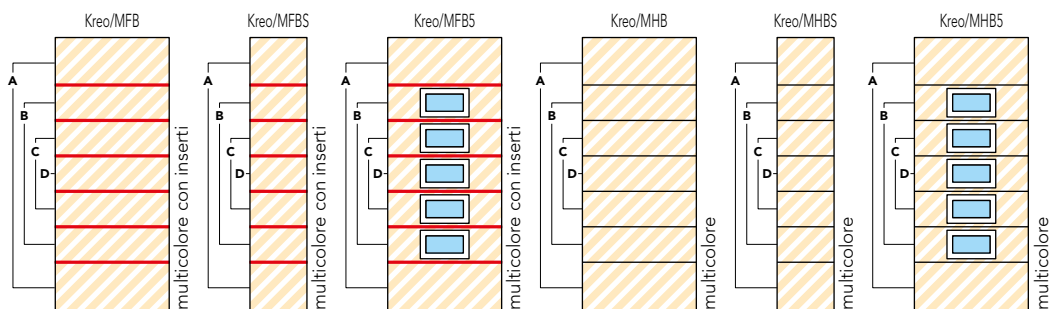

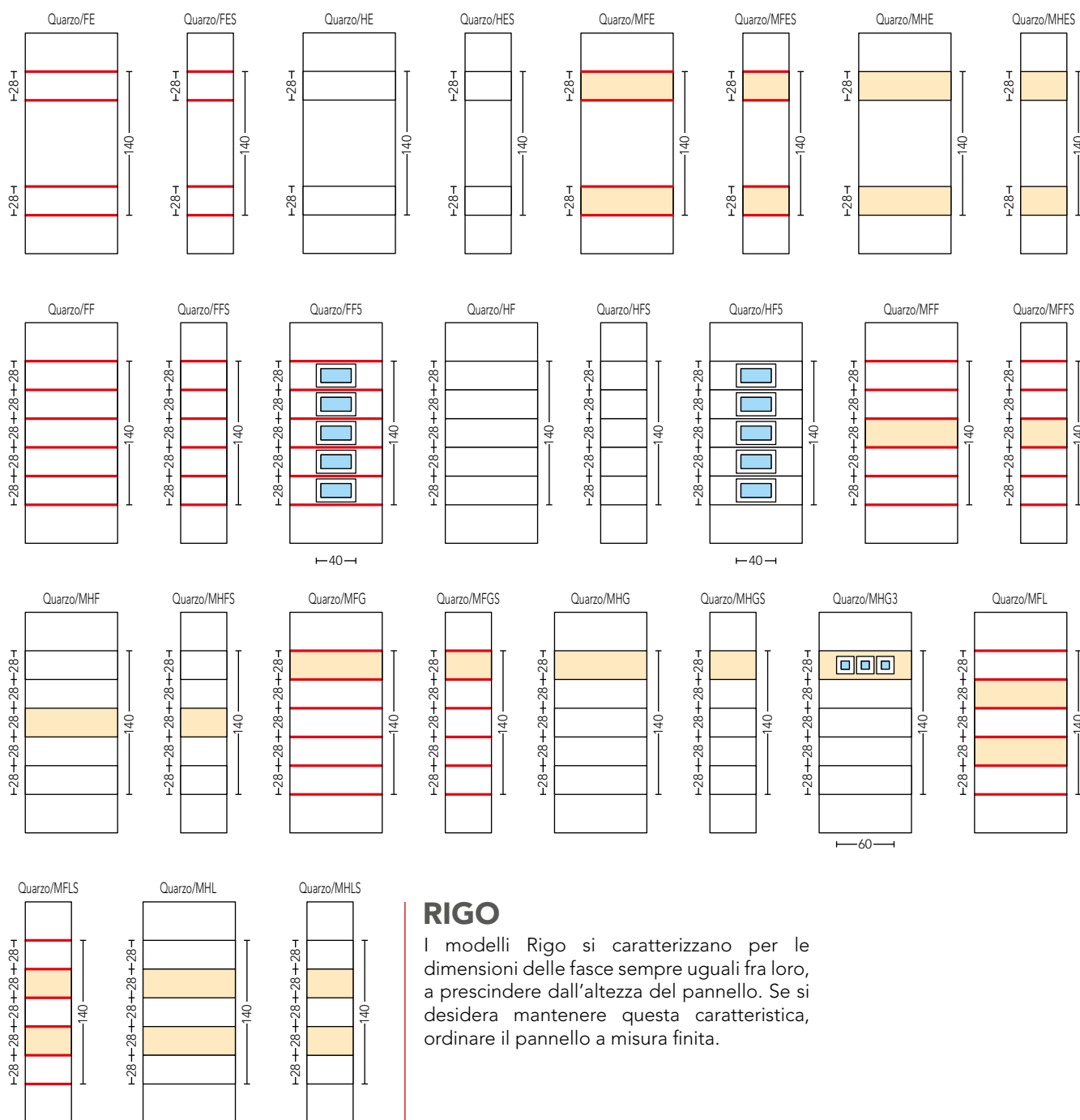

## RIGO

I modelli Rigo si caratterizzano per le dimensioni delle fasce sempre uguali fra loro, a prescindere dall'altezza del pannello. Se si desidera mantenere questa caratteristica, ordinare il pannello a misura finita.

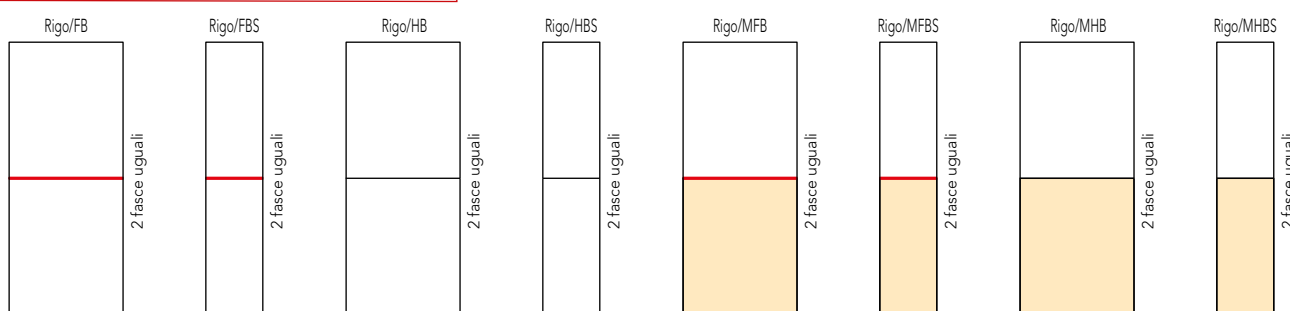

# DISEGNI





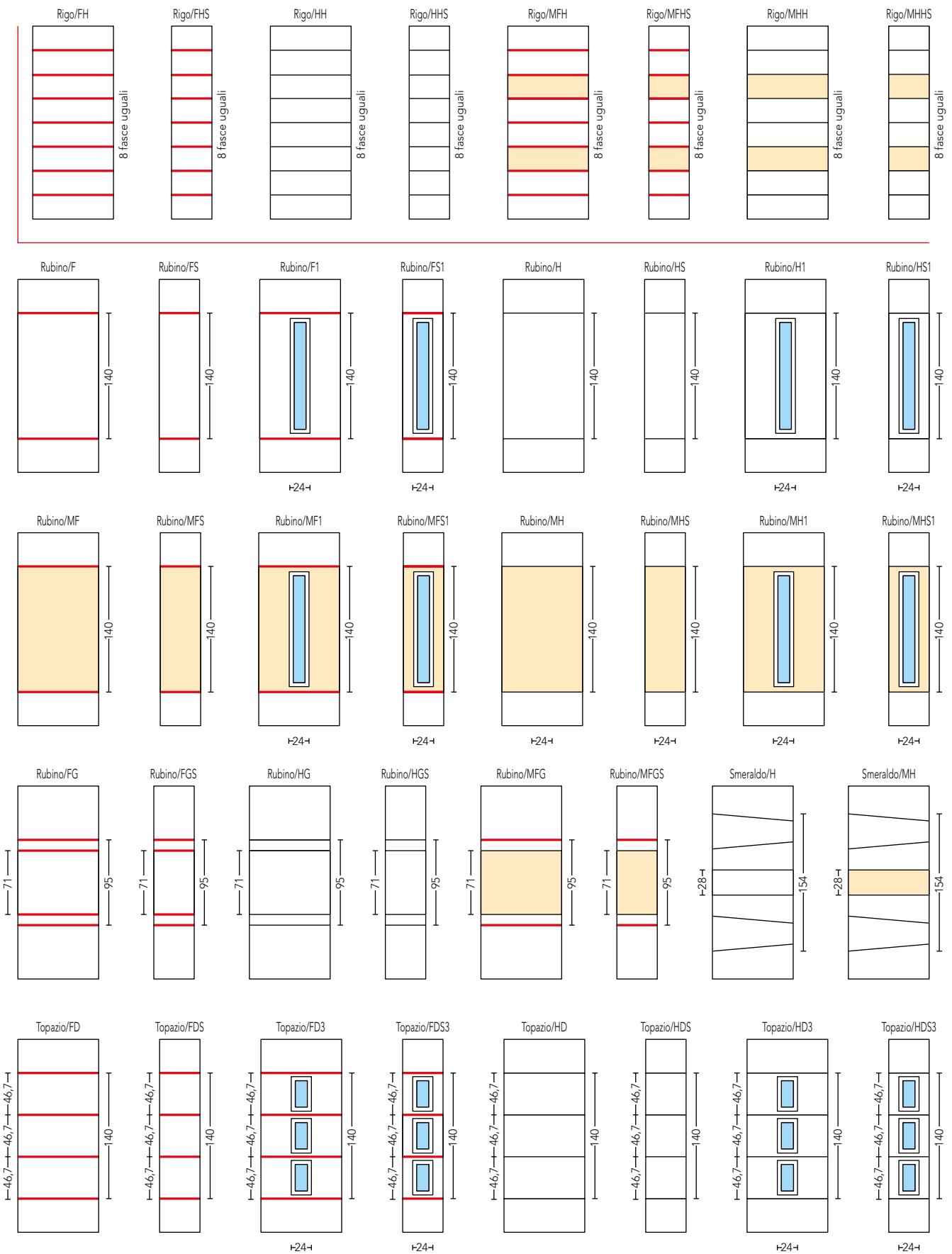

# DISEGNI

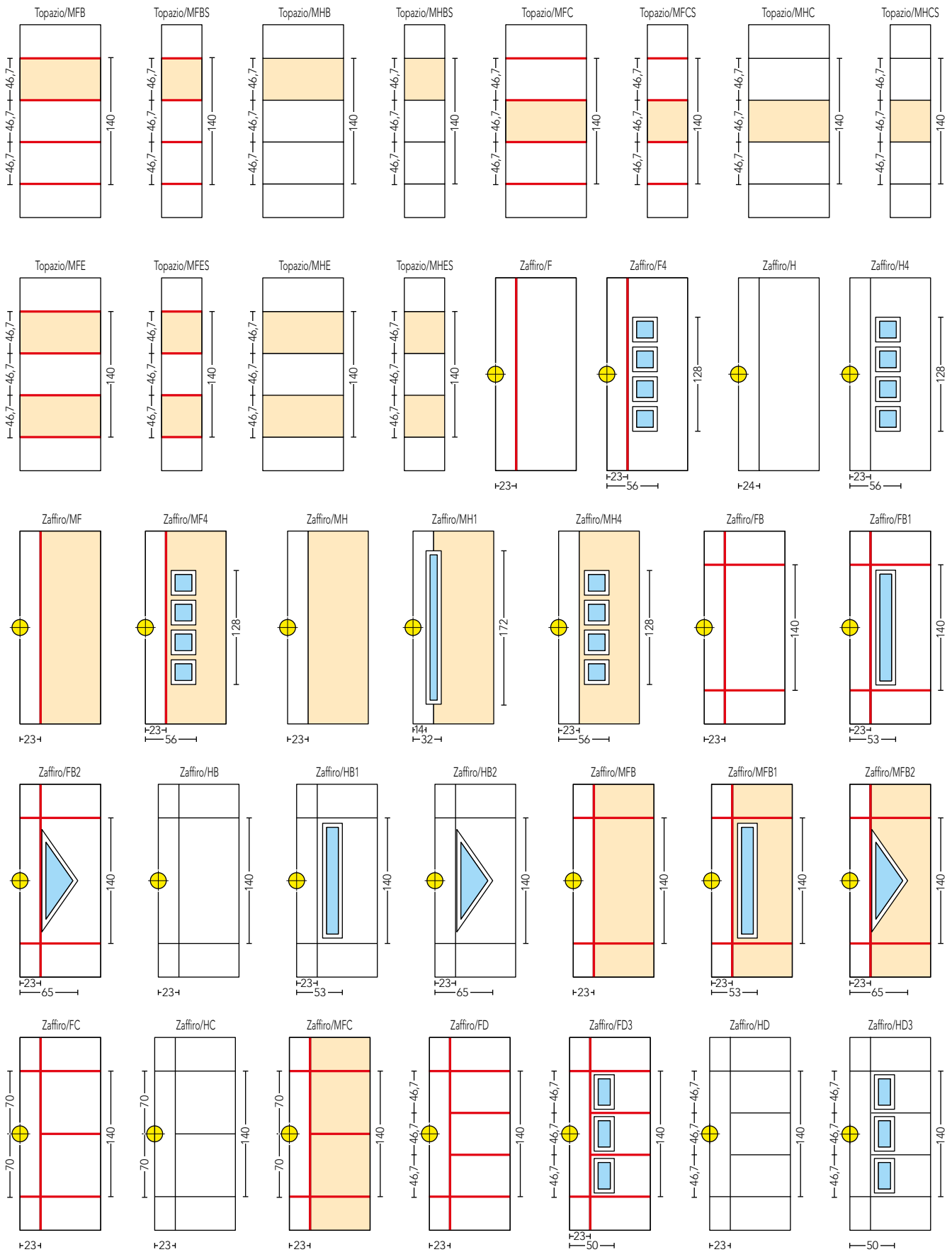

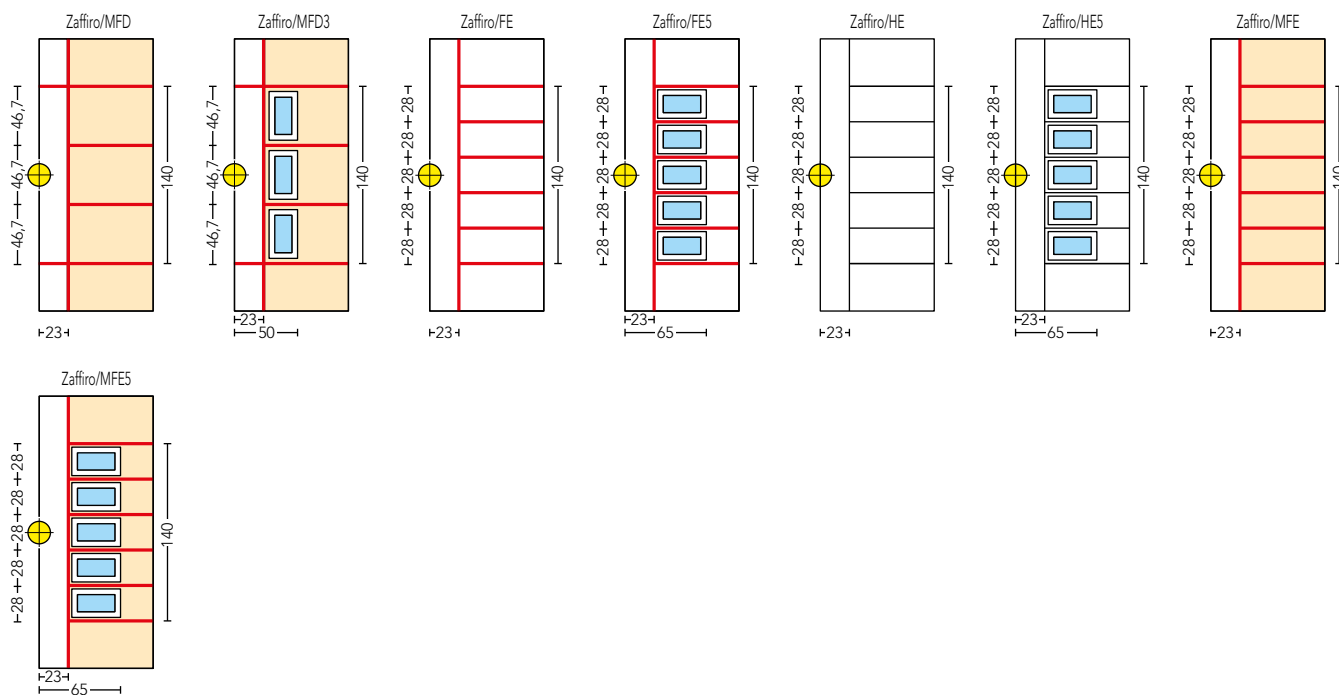

INFINITY

STYLE

**A FILO**

EMOTION

NOVECENTO

INCYSO

VETRI E DECORI

MANIGLIE

PENSILINE

COLORI

SEZ. TECNICA



162



Aluform



Amore a prima vista!

# EMOTION

Emoziona al primo sguardo e seduce al primo tocco. E' arte materica allo stato puro dove innovazione e design si fondono per creare una porta d'ingresso esclusiva, unica ed inconfondibile. Emotion è la protagonista di ogni ambiente.

INFINITY

STYLE

A FILO

EMOTION

NOVECENTO

INCYSO

VETRI E DECORI

MANIGLIE

PENSILINE

COLORI

SEZ. TECNICA

# INDICE

**ALCHIBA/WD**  
Pag. 250



**AMARCORD/W**  
Pag. 270



**AMARCORD/WDX**  
Pag. 271



**ASTRALIS/W**  
Pag. 237



**ASTRALIS/WX**  
Pag. 237



**ATLAS/W**  
Pag. 213



**ATLAS/WX**  
Pag. 213



**BASIC/W**  
Pag. 273



**BASIC/WM**  
Pag. 273



**BASIC/WD1**  
Pag. 239



**BIMOON/W**  
Pag. 210



**BIMOON/WX**  
Pag. 211



**BLOG/W**  
Pag. 222



**BLOG/W1**  
Pag. 223



**BOTEIN/W**  
Pag. 233



**BRAILLE/W**  
Pag. 262



**BRAILLE/W1**  
Pag. 263



**CARIDE/W**  
Pag. 260



**CARIDE/WX**  
Pag. 260



**CHANNEL/W**  
Pag. 257



**CHANNEL/W2**  
Pag. 257



**CHANNEL/W3**  
Pag. 257



**DESIRÉ/W**  
Pag. 254



**DESIRÉ/WX**  
Pag. 254



**DESIRÉ/WB**  
Pag. 255



**DESIRÉ/WBX**  
Pag. 255



**DIGIT/W**  
Pag. 225



**EGIZY/W**  
Pag. 229



**EGIZY/W1**  
Pag. 229



**EXAGON/W**  
Pag. 249



**EXAGON/WX**  
Pag. 248



**FLEX/W**  
Pag. 226



**FLEX/WB**  
Pag. 227



**FLEX/WB1**  
Pag. 227



**FLOWER/WD**  
Pag. 217



**FLOWER/WDX**  
Pag. 216



**FRISÈ/W**  
Pag. 235



**FRISÈ/WB**  
Pag. 235



**FUNNY/W**  
Pag. 241



**FUNNY/WX**  
Pag. 240



**GALAXY/W**  
Pag. 236



**GENIUS/W**  
Pag. 238



**GENIUS/WX**  
Pag. 239



**HIDRA/W**  
Pag. 243



**HIDRA/WX**  
Pag. 242



**JOINT/W**  
Pag. 264



**JOINT/WX**  
Pag. 264



**JOINT/WB**  
Pag. 265



INFINITY

STYLE

A FILO

EMOTION

NOVECENTO

INCYSO

VETRI E DECORI

MANIGLIE

PENSILINE

COLORI

SEZ. TECNICA

# INDICE

**JOINT/WBX**  
Pag. 265



**JOINT/WC**  
Pag. 267



**JOINT/WCX**  
Pag. 266



**JOINT/WD**  
Pag. 269



**JOINT/WDX**  
Pag. 268



**JOINT/WD1**  
Pag. 269



**JOLLY/WM1**  
Pag. 273



**JOLLY/WM2**  
Pag. 273



**LABIRINT/W**  
Pag. 230



**LUCE/W1**  
Pag. 274



**LUCE/WD1**  
Pag. 219



**LUCE/WE1**  
Pag. 274



**LUCE/WF3**  
Pag. 275



**LUCE/WH3**  
Pag. 275



**LUCE/WH4**  
Pag. 275



**MADRAS/W**  
Pag. 252



**MADRAS/WM**  
Pag. 253



**MADRAS/WX**  
Pag. 253



**MADRAS/WMX**  
Pag. 253



**NICHE/W**  
Pag. 209



**NICHE/WX**  
Pag. 209



**POINT/W**  
Pag. 232



**SANDY/W**  
Pag. 224



**SHANGAI/W**  
Pag. 228





**SIMPLE/W**  
Pag. 256



**SMOKY/W**  
Pag. 220



**SOFFY/W**  
Pag. 218



**SOFFY/WX**  
Pag. 219



**SPACE/W**  
Pag. 245



**SPACE/WX**  
Pag. 244



**STONE/WD**  
Pag. 215



**STONE/WDX**  
Pag. 214



**STREAM/W**  
Pag. 231



**STREAM/W1**  
Pag. 231



**STRIP/W**  
Pag. 259



**STRIP/WM**  
Pag. 259



**STRIP/WX**  
Pag. 259



**STRIP/WMX**  
Pag. 259



**STRIP/W1**  
Pag. 258



**TETRIS/W**  
Pag. 233



**TETRIS/W1**  
Pag. 233



**TRILOGY/W**  
Pag. 261



**TRILOGY/WX**  
Pag. 261



**VINTAGE/W**  
Pag. 247



**WIND/W**  
Pag. 212



**WIND/WX**  
Pag. 212



**WOOD/W**  
Pag. 225



INFINITY

STYLE

A FILO

EMOTION

NOVECENTO

INCISO

VETRI E DECORI

MANIGLIE

PENSILINE

COLORI

SEZ. TECNICA

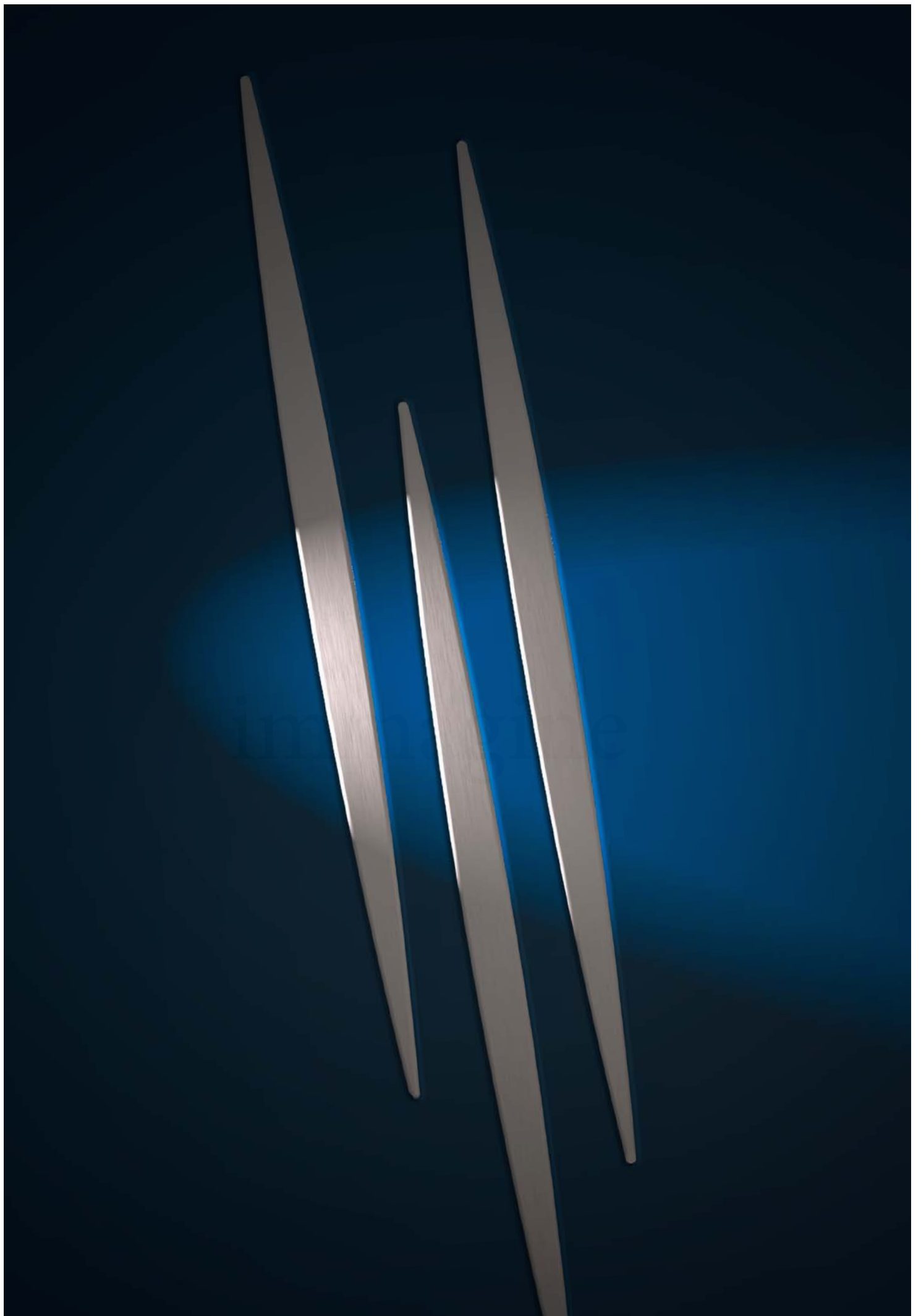

**NICHE/W**

Colore: RAL 5014 Grinz  
Maniglia: A 683



**NICHE/WX**

Colore: RAL 7016 Grinz  
Maniglia: A 619



INFINITY

STYLE

A FILO

**EMOTION**

NOVECENTO

INCYSO

VETRI E DECORI

MANIGLIE

PENSILINE

COLORI

SEZ. TECNICA

Niche/WS Niche/W

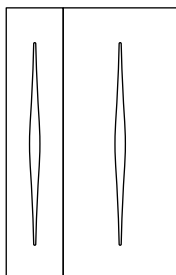

Niche/WSX Niche/WX

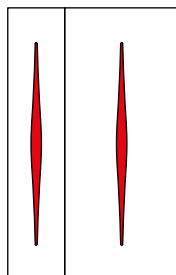

**EMOTION**  
COLLECTION



**BIMOON/W**  
Colore: RAL 5003 Grinz  
Maniglia: A 705

**NICHE/WS**

Colore:  
RAL 7005 Grinz

**BIMOON/W**

Colore: RAL 7005 Grinz  
Maniglia: A 700

**BIMOON/WX**

Colore: RAL 6009 Grinz  
Maniglia: A 691



INFINITY

STYLE

A FILO

EMOTION

NOVECENTO

INCYSO

VETRI E DECORI

MANIGLIE

PENSILINE

COLORI

SEZ. TECNICA

Niche/WS Bimoon/W

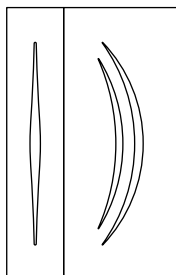

Niche/WSX Bimoon/WX

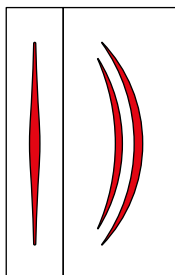

# EMOTION

COLLECTION

## STRIP/WSX

Colore:  
RAL 7011 Grinz  
Insero:  
RAL 7011 Lucido\*

## WIND/WX

Colore: RAL 7011 Grinz  
Insero: RAL 7011 Lucido\*  
Maniglia: A 624

## WIND/W

Colore: RAL 7038 Grinz  
Maniglia: A 946 N



Strip/WSX    Wind/WX

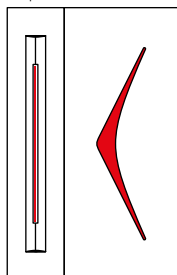

Jolly/WG1    Wind/W

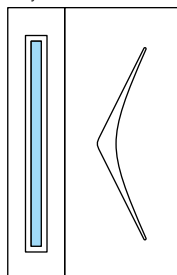

**ATLAS/W**

Colore: RAL 7035 Grinz  
Maniglia: A 944 R



**ATLAS/WSX**

Colore:  
RAL 5003 Grinz

**ATLAS/WX**

Colore: RAL 5003 Grinz  
Maniglia: A 691



\* Soluzione su richiesta

Atlas/WS

Atlas/W

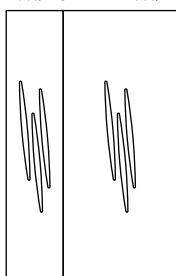

Atlas/WSX

Atlas/WX

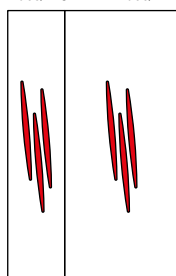

**EMOTION**  
COLLECTION



**TABLET/YS**  
Colore: RAL 6009 Grinz

**STONE/WDX**  
Colore: RAL 6009 Grinz  
Maniglia: A 944



**STONE/WX**

Colore: Orange AK38V Grinz  
Inserti: RAL 9005 Lucido\*  
Maniglia: A 944 N



\* Soluzione su richiesta

Tablet/YS	Stone/WDX	Stone/WX	Stone/WD	Stone/W



INFINITY

STYLE

A FILO

EMOTION

NOVECENTO

INCYSO

VETRI E DECORI

MANIGLIE

PENSILINE

COLORI

SEZ. TECNICA

**EMOTION**  
COLLECTION



**FLOWER/WDX**  
Colore: RAL 7038 Grinz  
Maniglia: A 951

**FLOWER/WD**

Colore: RAL 7005 Grinz  
Maniglia: A 689



**FLOWER/WDX**

Colore: RAL 3005 Grinz  
Maniglia: A 951



**FLOWER/WX**

Colore: RAL 3005 Grinz  
Maniglia: A 951

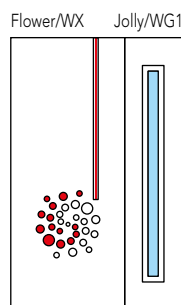
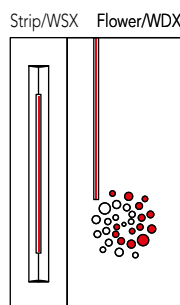
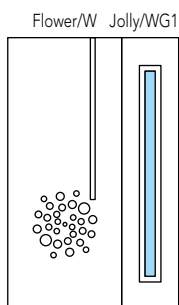
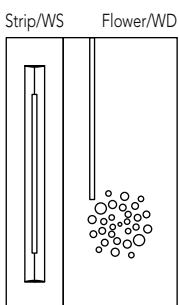



**SOFFY/W**

Colore: RAL 9006 Grinz

Maniglia: A 946 R



Strip/WS

Soffy/W

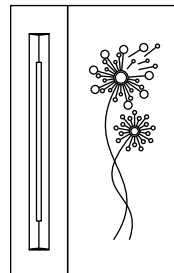

**SOFFY/WX**

Colore: RAL 5010 Grinz  
Maniglia: A 946



**LUCE/WD1**

Colore: Bleu AK15V Grinz  
Cornice vetro: alluminio effetto Inox\*  
Vetro: decoro SO (38)  
Maniglia: A 691



\* Soluzione su richiesta

Strip/WSX    Soffy/WX

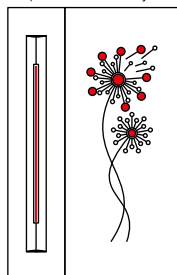

Luce/WD1

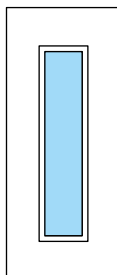

INFINITY

STYLE

A FILO

**EMOTION**

NOVECENTO

INCYSO

VETRI E DECORI

MANIGLIE

PENSILINE

COLORI

SEZ. TECNICA

**EMOTION**  
COLLECTION



**TABLET/YS**  
Colore: Bleu AK15V Grinz

**SMOKY/W**  
Colore: Bleu AK15V Grinz  
Maniglia: A 691

### LUCE/WD1

Colore: Antracite P016V Grinz  
Cornice vetro: alluminio effetto Inox\*  
Vetro: decoro SM (38)  
Maniglia: A 944



\* Soluzione su richiesta

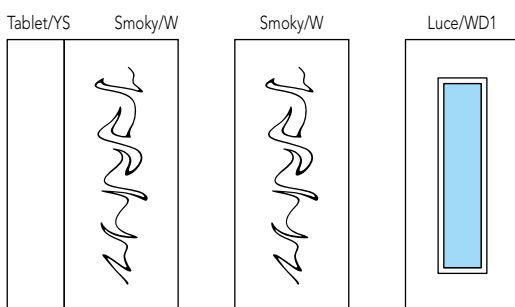

INFINITY

STYLE

A FILO

EMOTION

NOVECENTO

INCYSO

VETRI E DECORI

MANIGLIE

PENSILINE

COLORI

SEZ. TECNICA



**numero civico NC...**  
placca + 2 cifre

**pensilina TRENDY mod. TR-01**  
Colore struttura: RAL 9010 Grinz  
Colore mensole: Orange AK38V Grinz  
Copertura: trasparente

**porta BLOG/W**  
Colore: Orange AK38 Grinz  
Maniglia: A 692



**BLOG/W**

Colore: RAL 7006 Grinz  
Maniglia: A 692



**BLOG/W1**

Colore: Orange AK38V Grinz  
Vetro: decoro BL (77)  
Maniglia: A 693



INFINITY

STYLE

A FILO

**EMOTION**

NOVECENTO

INCYSO

VETRI E DECORI

MANIGLIE

PENSILINE

COLORI

SEZ. TECNICA

Jolly/WG1      Blog/W

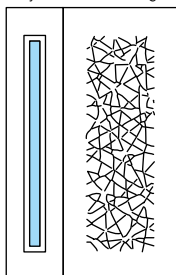

Tablet/YS      Blog/W1

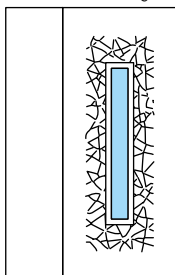



**SANDY/W**

Colore: Beige AK12V Grinz Mix  
Maniglia: A 692

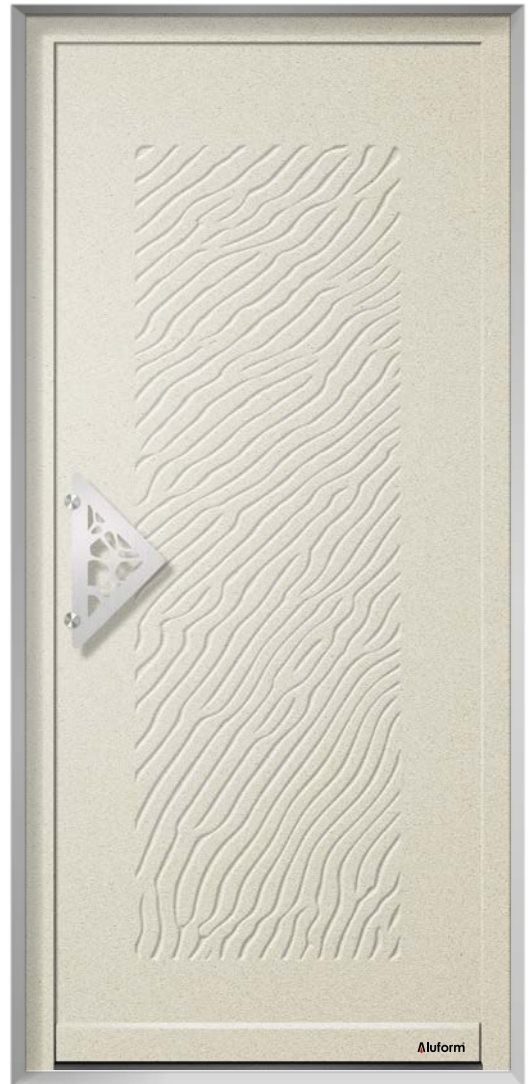

Tablet/YS Sandy/W

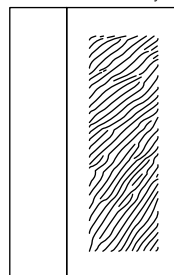

**WOOD/W**

Colore: RAL 7030 Grinz  
Maniglia: A 693

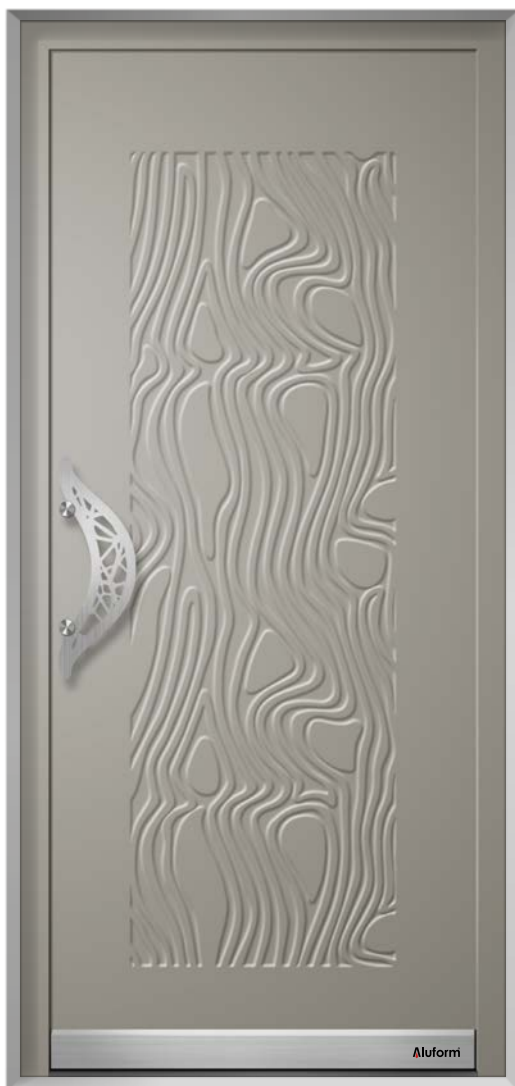

**DIGIT/W**

Colore: RAL 5003 Grinz  
Maniglia: A 705



INFINITY

STYLE

A FILO

**EMOTION**

NOVECENTO

INCYSO

VETRI E DECORI

MANIGLIE

PENSILINE

COLORI

SEZ. TECNICA

Strip/WS Wood/W

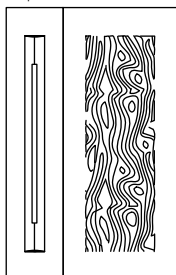

Jolly/WG1 Digit/W

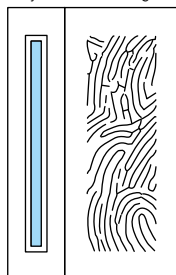

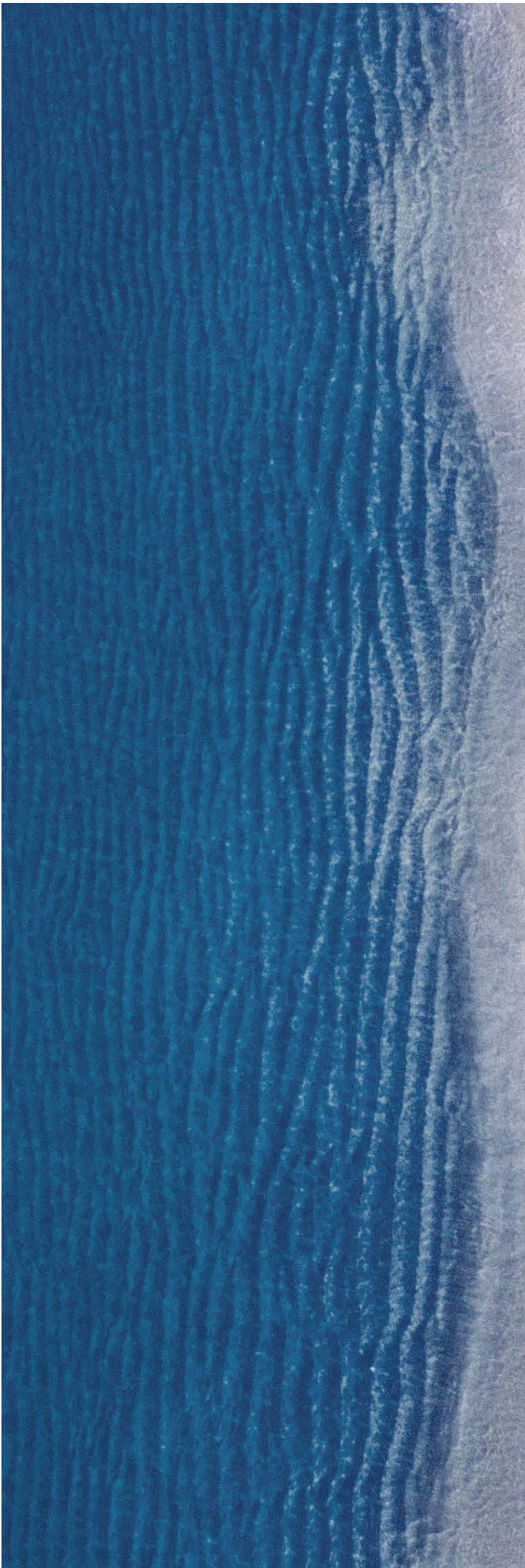

**FLEX/W**

Colore: RAL 5014 Grinz

Maniglia: A 703



Niche/WS

Flex/W

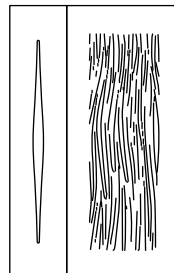

**FLEX/WB**

Colore: RAL 7011 Grinz  
Maniglia: A 700



**FLEX/WB1**

Colore: Antracite P016V Grinz  
Cornice vetro: alluminio effetto Inox\*  
Vetro: decoro FL (77)  
Maniglia: A 693



INFINITY

STYLE

A FILO

**EMOTION**

NOVECENTO

INCYSO

VETRI E DECORI

MANIGLIE

PENSILINE

COLORI

SEZ. TECNICA

\* Soluzione su richiesta

Tablet/YS

Flex/WB

Flex/WB1

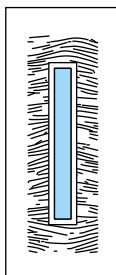
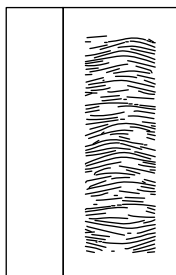

## EMOTION COLLECTION

### SHANGAI/W

Colore: Bleu AK15V Grinz  
Maniglia: A 703



### LUCE/WD1

Colore: Grigio P7000 Mix  
Cornice vetro: alluminio effetto Inox\*  
Vetro: decoro SH (38)  
Maniglia: A 971



Strip/WS Shanghai/W

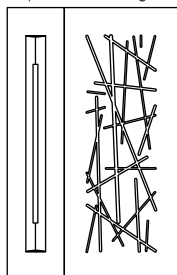

Tablet/YS Luce/WD1

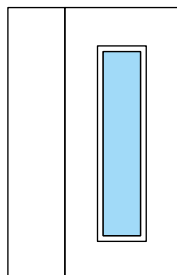

**EGIZY/W**

Colore: Corten AK10V Grinz Mix  
Maniglia: A 618

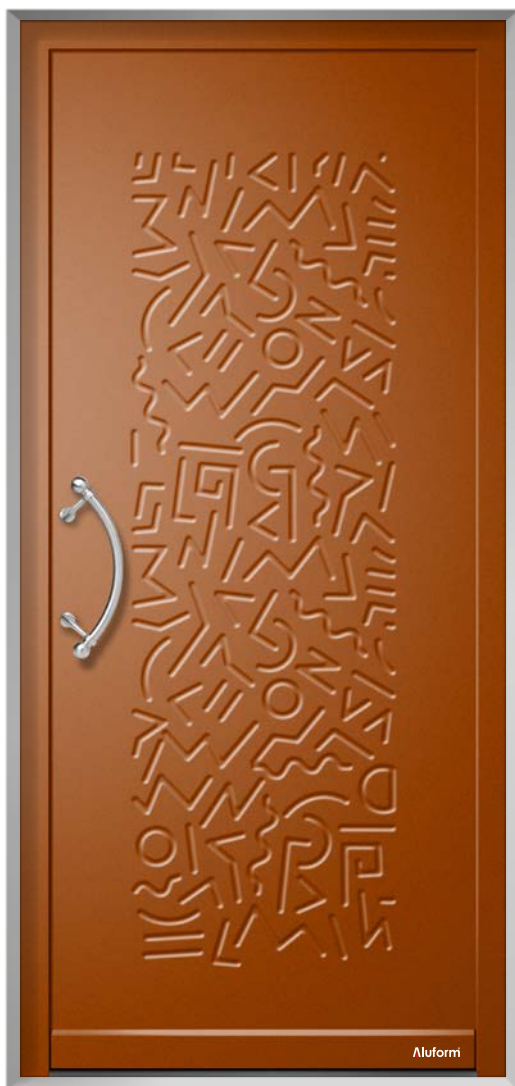

**EGIZY/W1**

Colore: Corten V001V Grinz Mix  
Vetro: decoro EG (77)  
Maniglia: A 618



INFINITY

STYLE

A FILO

**EMOTION**

NOVECENTO

INCYSO

VETRI E DECORI

MANIGLIE

PENSILINE

COLORI

SEZ. TECNICA

\* Soluzione su richiesta

Jolly/WG1 Egizy/W

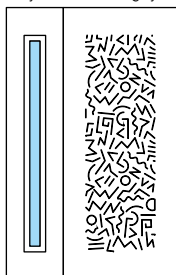

Egizy/W1

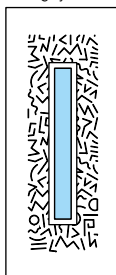



**LABIRINT/W**

Colore: Noce RP07L

Maniglia: A 418



Strip/WS

Labirint/W

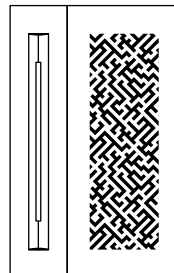



**STREAM/W**

Colore: RAL 7006 Grinz  
Maniglia: A 692



**STREAM/W1**

Colore: RAL 7032 Grinz  
Vetro: decoro ST (72)  
Maniglia: A 951



INFINITY

STYLE

A FILO

**EMOTION**

NOVECENTO

INCYSO

VETRI E DECORI

MANIGLIE

PENSILINE

COLORI

SEZ. TECNICA

Basic/WS Stream/W

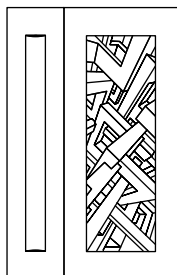

Jolly/WG1 Stream/W1

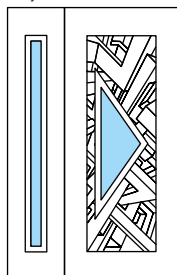

**EMOTION**  
COLLECTION



**BASIC/WS**  
Colore: RAL 9005 Grinz

**POINT/W**  
Colore: RAL 9005 Grinz  
Maniglia: A 691

**TETRIS/W**

Colore: RAL 7015 Grinz  
Maniglia: A 955 R



**TETRIS/W1**

Colore: RAL 5003 Grinz  
Cornice vetro: alluminio effetto Inox\*  
Vetro: decoro TE (67)  
Maniglia: A 951



**BOTEIN/W**

Colore: RAL 7011 Grinz  
Maniglia: A 961 R

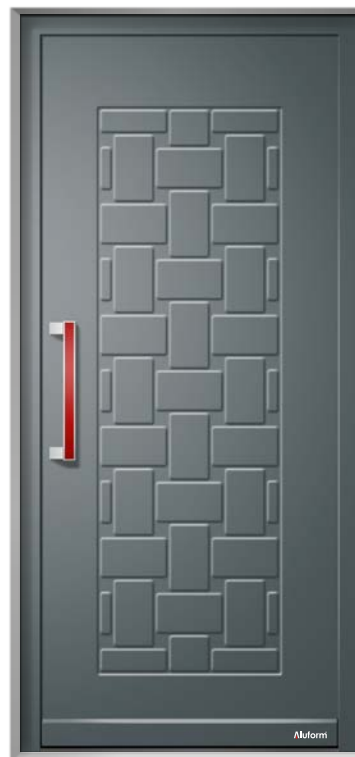

\* Soluzione su richiesta

Basic/WS Point/W

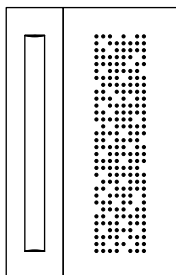

Tetris/W

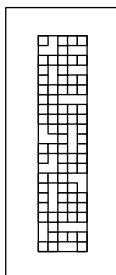

Jolly/WG1 Tetris/W1

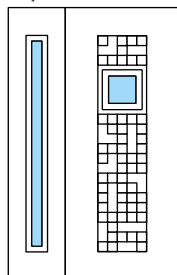

Basic/WS Botein/W

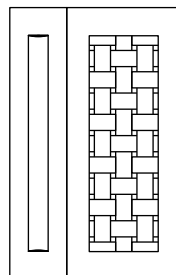



**FRISÈ/W**

Colore: RAL 5014 Grinz  
Maniglia: A 517



**FRISÈ/WB**

Colore: RAL 7035 Grinz  
Maniglia: A 622



Frisè/W

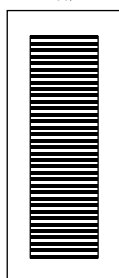

Frisè/WB

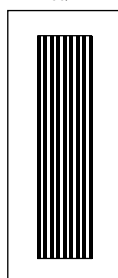

INFINITY

STYLE

A FILO

**EMOTION**

NOVECENTO

INCYSO

VETRI E DECORI

MANIGLIE

PENSILINE

COLORI

SEZ. TECNICA

**EMOTION**  
COLLECTION



**STRIP/WS**  
Colore: RAL 8019 Grinz

**GALAXY/W**  
Colore: RAL 8019 Grinz  
Maniglia: A 705

**ASTRALIS/W**

Colore: RAL 6009 Grinz  
Maniglia: A 685



**ASTRALIS/WX**

Colore: RAL 5003 Grinz  
Maniglia: A 700



INFINITY

STYLE

A FILO

**EMOTION**

NOVECENTO

INCYSO

VETRI E DECORI

MANIGLIE

PENSILINE

COLORI

SEZ. TECNICA

Strip/WS Galaxy/W

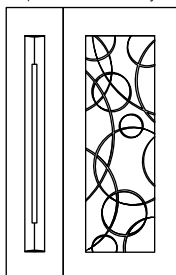

Jolly/WG1 Astralis/W

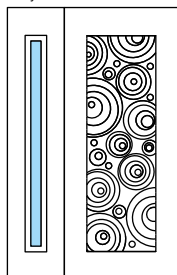

Strip/WSX Astralis/WX

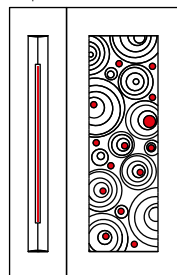

**EMOTION**  
COLLECTION



**JOLLY/WG1**

Colore: Antracite P016V Grinz  
Vetro: decoro RC (31)

**GENIUS/W**

Colore: Antracite P016V Grinz  
Maniglia: A 705



**GENIUS/WX**

Colore: Bleu AK15V Grinz  
Maniglia: A 689



**BASIC/WD1**

Colore: RAL 5003 Grinz  
Cornice vetro: alluminio effetto Inox\*  
Vetro: decoro GE (38)  
Maniglia: A 685



\* Soluzione su richiesta

Jolly/WG1 Genius/W

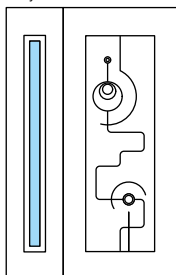

Strip/WS Genius/W

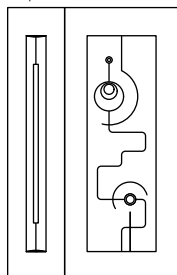

Strip/WSX Genius/WX

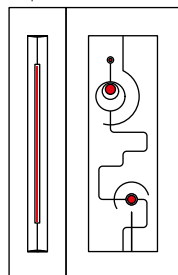

Basic/WD1

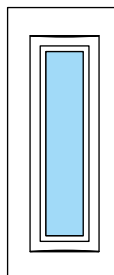

INFINITY

STYLE

A FILO

EMOTION

NOVECENTO

INCYSO

VETRI E DECORI

MANIGLIE

PENSILINE

COLORI

SEZ. TECNICA



**MADRAS/WSX**

Colore: RAL 7035 Grinz  
Inserti: RAL 9005 Lucido\*

**FUNNY/WX**

Colore: RAL 7035 Grinz  
Inserti: RAL 9005 Lucido\*  
Maniglia: A 961 N

**FUNNY/W**

Colore: Ambra AK40V Grinz  
Maniglia: A 687



**BASIC/WD1**

Colore: Ciliegio RP02L  
Vetro: decoro FU (38)  
Maniglia: A 688



INFINITY

STYLE

A FILO

**EMOTION**

NOVECENTO

INCYSO

VETRI E DECORI

MANIGLIE

PENSILINE

COLORI

SEZ. TECNICA

\* Soluzione su richiesta

Jolly/WG1 Funny/W

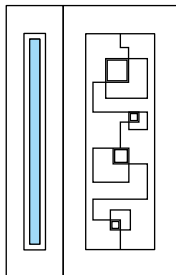

Strip/WS Funny/W

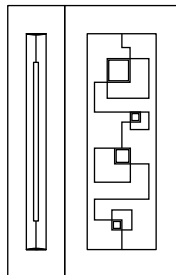

Strip/WSX Funny/WX

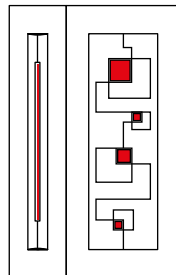

Basic/WD1

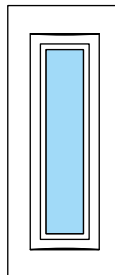



217



Aluform

**numero civico NC...**  
placca + 3 cifre

**porta HIDRA/WX**  
Colore: RAL 5003 Grinz  
Maniglia: A 622

**HIDRA/W**

Colore: RAL 5014 Grinz  
Maniglia: A 961



**HIDRA/WX**

Colore: Melon AK37V Grinz  
Maniglia: A 622



INFINITY

STYLE

A FILO

**EMOTION**

NOVECENTO

INCYSO

VETRI E DECORI

MANIGLIE

PENSILINE

COLORI

SEZ. TECNICA

Basic/WS    Hidra/W

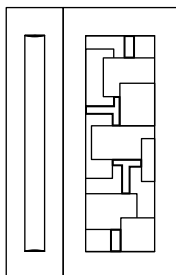

Jolly/WG1    Hidra/W

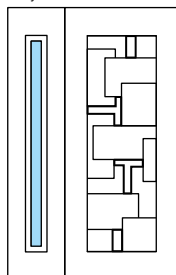

Strip/WSX    Hidra/WX

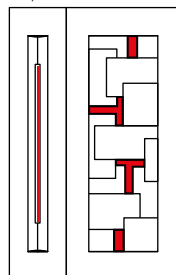

**EMOTION**  
COLLECTION



**STRIP/WSX**

Colore: RAL 5003 Grinz  
Inseriti: RAL 5003 Lucido\*

**SPACE/WX**

Colore: RAL 5003 Grinz  
Inseriti: RAL 5003 Lucido\*  
Maniglia: A 506

**SPACE/W**

Colore: RAL 5010 Grinz  
Maniglia: A 506



**BASIC/WD1**

Colore: Porpora AK39V Grinz  
Cornice vetro: alluminio effetto Inox\*  
Vetro: decoro SP (38)  
Maniglia: A 971



\* Soluzione su richiesta

Jolly/WG1    Space/W

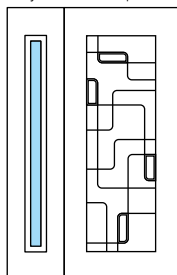

Strip/WS    Space/W

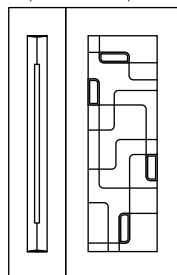

Strip/WSX    Space/WX

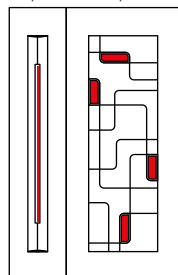

Basic/WD1

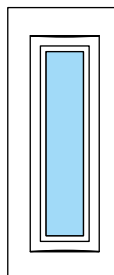





**VINTAGE/W**

Colore: RAL 3005 Grinz  
Maniglia: A 687



**BASIC/WD1**

Colore: RAL 8019 Grinz  
Cornice vetro: alluminio effetto Inox\*  
Vetro: decoro VI (38)  
Maniglia: A 961 N



\* Soluzione su richiesta

Jolly/WG1 Vintage/W

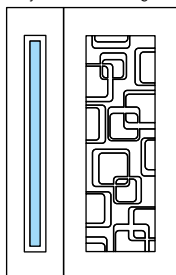

Strip/WS Vintage/W

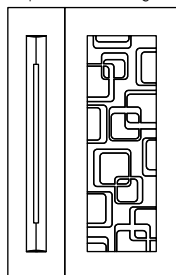

Basic/WD1

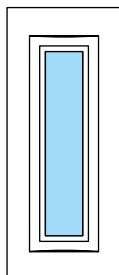



**EXAGON/WX**

Colore: Antracite P016V Grinz

Maniglia: A 515



Strip/WSX Exagon/WX

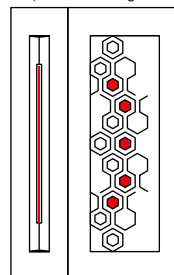

**EXAGON/W**

Colore: Rosso P7300 Mix  
Maniglia: A 515



**BASIC/WD1**

Colore: Bianco P7503 Grinx Mix  
Cornice vetro: alluminio effetto Inox\*  
Vetro: decoro EX (38)  
Maniglia: A 518



\* Soluzione su richiesta

Strip/WS Exagon/W

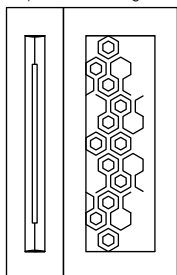

Jolly/WG1 Exagon/W

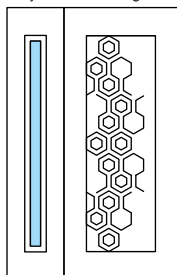

Basic/WD1

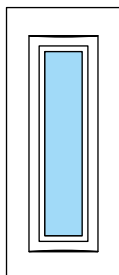



**ALCHIBA/WD**

Colore: RAL 3004 Grinz

Maniglia: A 506



Jolly/WG1 Alchiba/WD

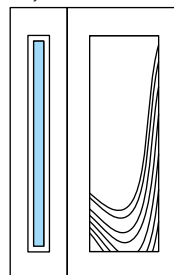

**ALCHIBA/W**

Colore: RAL 7030 Grinz  
Maniglia: A 506

**ALCHIBA/WD**

Colore: RAL 7030 Grinz  
Maniglia: A 506



INFINITY

STYLE

A FILO

**EMOTION**

NOVECENTO

INCYSO

VETRI E DECORI

MANIGLIE

PENSILINE

COLORI

SEZ. TECNICA

Strip/WS Alchiba/W

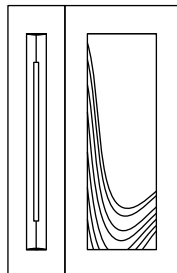

Alchiba/WD Alchiba/W

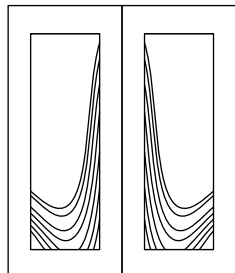



**MADRAS/WS**

Colore: Bleu AK15V  
Grinz

**MADRAS/W**

Colore: Bleu AK15V Grinz  
Maniglia: A 945



Madras/WS Madras/W

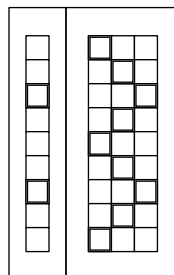

**MADRAS/WX**

Colore: Antracite P016V Grinz  
Inserti: RAL 7030 Lucido\*  
Maniglia: A 961 R



**MADRAS/WX**

Colore: Ciliegio RP03L  
Maniglia: A 951 C



INFINITY

STYLE

A FILO

**EMOTION**

NOVECENTO

INCYSO

VETRI E DECORI

MANIGLIE

PENSILINE

COLORI

SEZ. TECNICA

\* Soluzione su richiesta

Madras/WSX Madras/WX

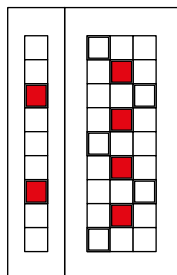

Jolly/WG1 Madras/WX

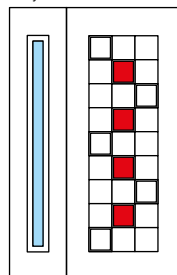

Madras/MM

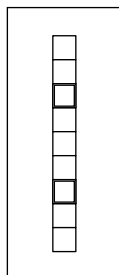

Madras/MMX

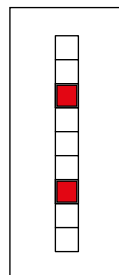

**DESIRÉ/W**

Colore: RAL 7015 Grinz  
Maniglia: A 518



**DESIRÉ/WX**

Colore: Antracite P016V Grinz  
Maniglia: A 622



Triade/YS Desire/W

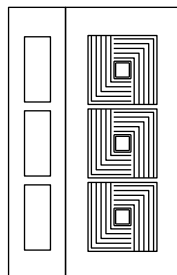

Jolly/WG1 Desire/W

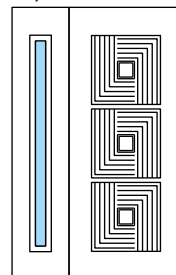

Strip/WSX Desire/WX

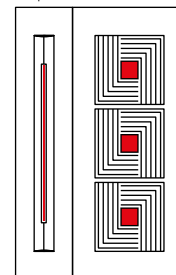



**DESIRÉ/WB**

Colore: RAL 8014 Grinz  
Maniglia: A 961



**DESIRÉ/WBX**

Colore: Ciliegio RP03L  
Maniglia: A 622



**DESIRÉ/WBX**

Colore: Ciliegio RP03L  
Maniglia: A 622

Strip/WS Desire/WB

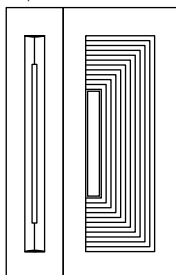

Jolly/WG1 Desire/WB

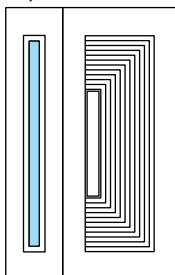

Strip/WSX Desire/WBX

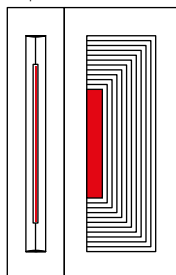

**EMOTION**  
COLLECTION



**BASIC/WS**  
Colore: Corten RP101M

**SIMPLE/W**  
Colore: Corten RP101M  
Maniglia: A 705

**CHANNEL/W**

Colore: Grigio P7003 Grinz Mix  
Maniglia: A 700



**CHANNEL/W2**

Colore: Grigio P7000 Mix  
Vetro: satinato D (40)  
Maniglia: A 703



**CHANNEL/W3**

Colore: RAL 7030 Grinz  
Cornice vetro: allum. effetto Inox\*  
Vetro: decoro GS (40)  
Maniglia: A 518



\* Soluzione su richiesta

Basic/WS Simple/W

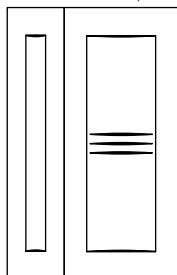

Jolly/WG1 Simple/W

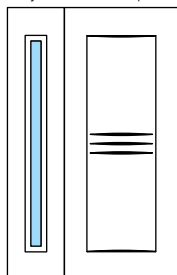

Basic/WS Channel/W

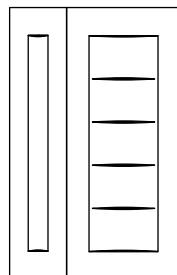

Strip/WS Channel/W2

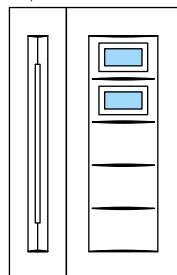

Jolly/WG1 Channel/W3

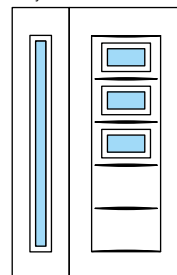

**EMOTION**  
COLLECTION



**JOLLY/WG1**

Colore: RAL 6009 Grinz  
Vetro: decoro RC (31)

**STRIP/W1**

Colore: RAL 6009 Grinz  
Vetro: decoro RC (77)  
Maniglia: A 624

**STRIP/W**

Colore: RAL 6005 Grinz  
Maniglia: A 518



**STRIP/WX**

Colore: RAL 6021 Grinz  
Maniglia: A 518



**STRIP/WMX**

Colore: RAL 7038 Grinz  
Insero: RAL 9005 Lucido\*  
Maniglia: A 516



\* Soluzione su richiesta

Jolly/WG1 Strip/W1

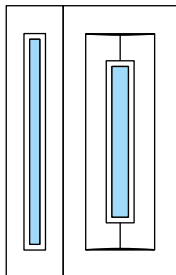

Strip/WS Strip/W

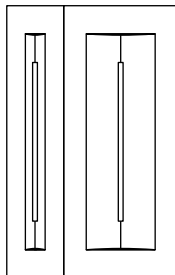

Strip/WSX Strip/WX

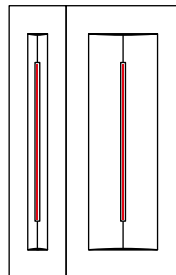

Strip/WM

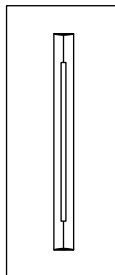

Strip/WMX

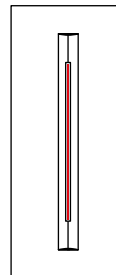

**EMOTION**  
COLLECTION

**CARIDE/W**

Colore: Rosso P7300 Mix  
Maniglia: A 518

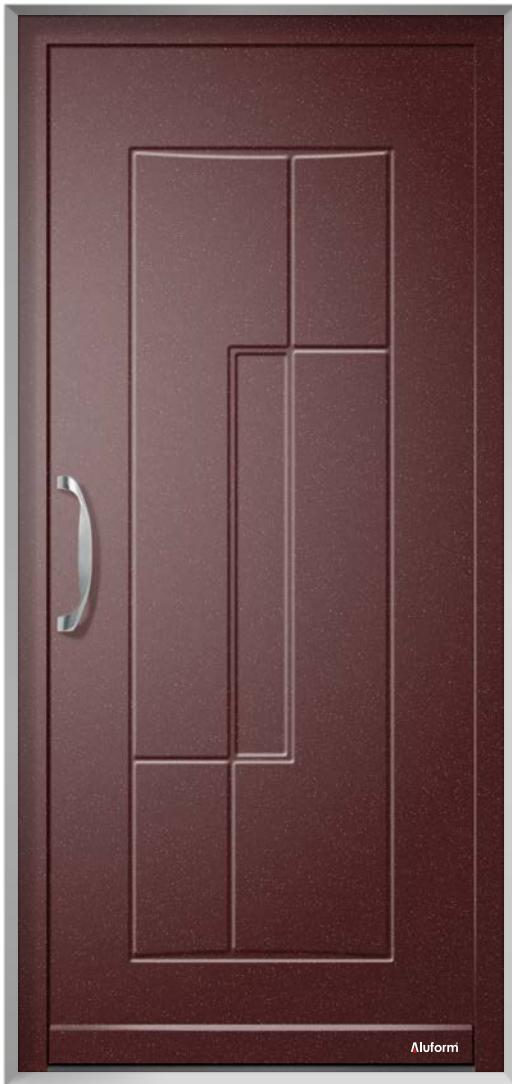

**CARIDE/WX**

Colore: Noce RP08L  
Maniglia: A 622



Basic/WS Caride/W

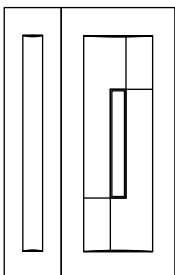

Jolly/WG1 Caride/W

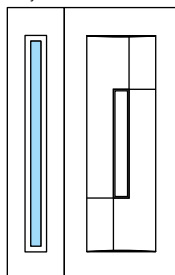

Strip/WS Caride/W

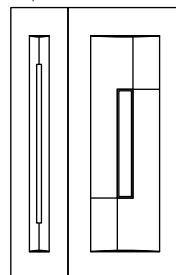

Strip/WSX Caride/WX

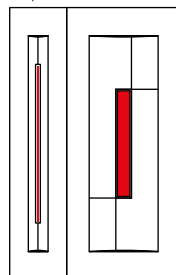

**TRILOGY/W**

Colore: Bronzo TR03V Grinz  
Maniglia: A 418

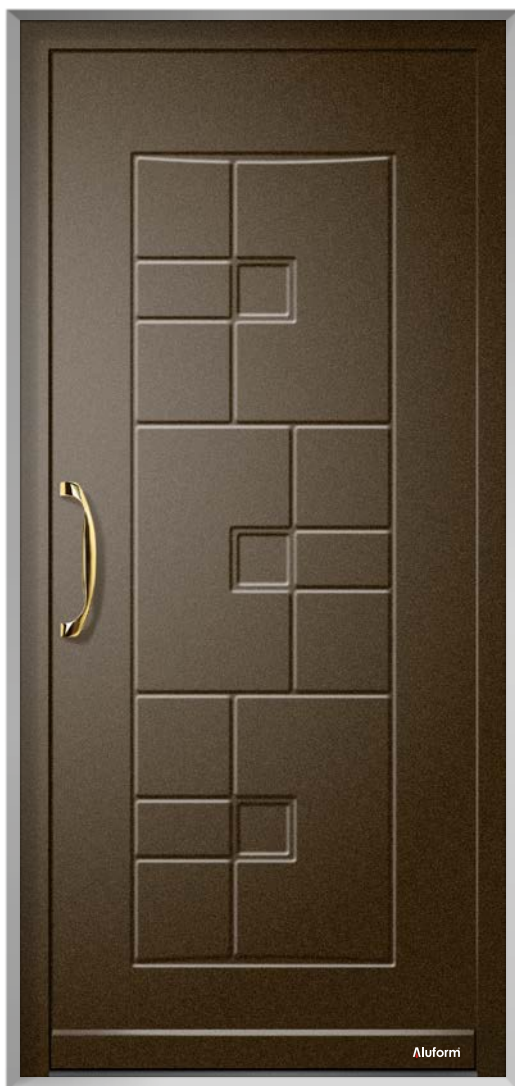

**TRILOGY/WX**

Colore: RAL 6009 Grinz  
Maniglia: A 518



INFINITY

STYLE

A FILO

**EMOTION**

NOVECENTO

INCYSO

VETRI E DECORI

MANIGLIE

PENSILINE

COLORI

SEZ. TECNICA

Strip/WS Trilogy/W

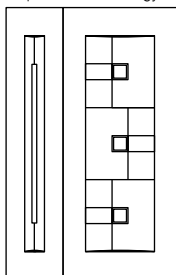

Strip/WSX Trilogy/WX

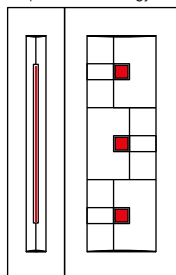



**numero civico NC...**  
placca + 2 cifre

**pensilina NEW STYLE mod. NS-02**  
Colore struttura: RAL 9005 Grinz  
Copertura: trasparente

**porta BRAILLE/W**  
Colore: RAL 9005 Grinz  
Maniglia: A 963 N



**BRILLE/W**

Colore: Rame Bugnato AK02V  
Maniglia: A 701

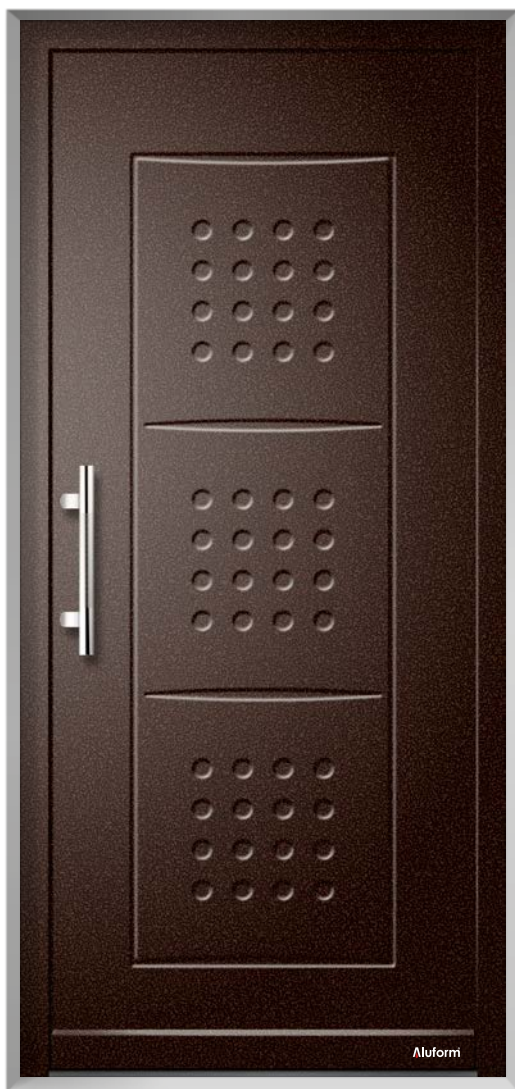

**BRILLE/W1**

Colore: Corten RP101M  
Cornice vetro: alluminio effetto Inox\*  
Vetro: decoro BR (25)  
Maniglia: A 951



INFINITY

STYLE

A FILO

**EMOTION**

NOVECENTO

INCYSO

VETRI E DECORI

MANIGLIE

PENSILINE

COLORI

SEZ. TECNICA

\* Soluzione su richiesta

Basic/WS      Braille/W

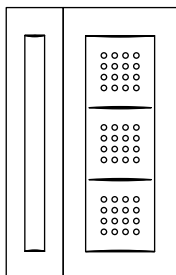

Strip/WS      Braille/W1

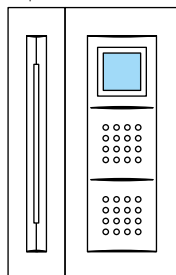

**EMOTION**  
COLLECTION

**JOINT/W**

Colore: RAL 7005 Grinz  
Maniglia: A 418



**JOINT/WX**

Colore: Ghisa RP102M  
Maniglia: A 622



Basic/WS Joint/W

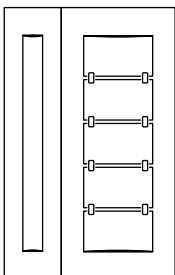

Strip/WSX Joint/WX

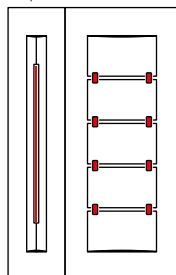

**JOINT/WB**

Colore: RAL 1013 Grinz  
Maniglia: A 951



**JOINT/WBX**

Colore: Ciliegio RP02L  
Maniglia: A 622



INFINITY

STYLE

A FILO

**EMOTION**

NOVECENTO

INCYSO

VETRI E DECORI

MANIGLIE

PENSILINE

COLORI

SEZ. TECNICA

Strip/WS Joint/WB

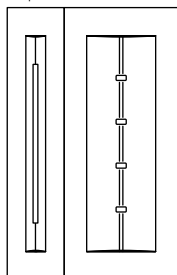

Jolly/WG1 Joint/WBX

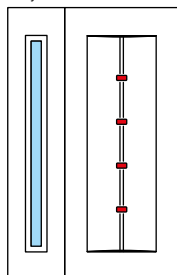

**EMOTION**  
COLLECTION



**STRIP/WSX**

Colore: RAL 9007 Grinz  
Insero: RAL 3003 Lucido\*

**JOINT/WCX**

Colore: RAL 9007 Grinz  
Inseri: RAL 3003 Lucido\*  
Maniglia: A 703

**JOINT/WC**

Colore: RAL 1019 Grinz  
Maniglia: A 702



**JOINT/WCX**

Colore: Ciliegio RP02L  
Maniglia: A 703



INFINITY

STYLE

A FILO

**EMOTION**

NOVECENTO

INCYSO

VETRI E DECORI

MANIGLIE

PENSILINE

COLORI

SEZ. TECNICA

\* Soluzione su richiesta

Strip/WSX Joint/WC

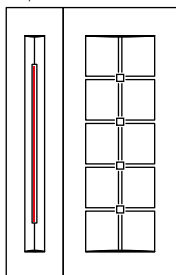

Strip/WS Joint/WCX

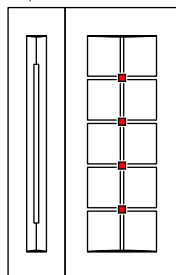



32

Aluform

numero civico NC...  
placca + 2 cifre

porta **JOINT/WDX**  
Colore: RAL 8019 Grinz  
Maniglia: A 518

**JOINT/WD1**

Colore: RAL 7030 Grinz  
Cornice vetro: alluminio effetto Inox\*  
Vetro: decoro JO (77)  
Maniglia: A 507



**JOINT/WD**

Colore: Verde P7103 Grinz Mix  
Maniglia: A 518



INFINITY

STYLE

A FILO

**EMOTION**

NOVECENTO

INCYSO

VETRI E DECORI

MANIGLIE

PENSILINE

COLORI

SEZ. TECNICA

\* Soluzione su richiesta

Jolly/WG1 Joint/WDX

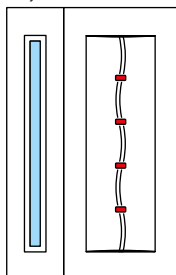

Basic/WS Joint/WD1

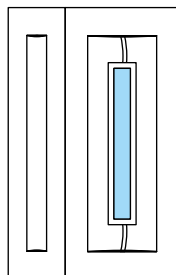

Strip/WS Joint/WD

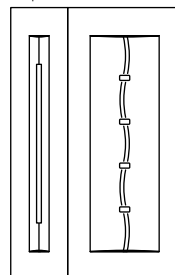



**numero civico NC...**  
placca + 1 cifra

**porta AMARCORD/W**  
Colore: Ciliegio PVC RP04L  
Maniglia: A 700



**AMARCORD/W**

Colore: RAL 3005 Grinz  
Maniglia: A 945



**AMARCORD/WDX**

Colore: Corten RP101M  
Maniglia: A 700



INFINITY

STYLE

A FILO

**EMOTION**

NOVECENTO

INCYSO

VETRI E DECORI

MANIGLIE

PENSILINE

COLORI

SEZ. TECNICA

Basic/WS Amarcord/WD

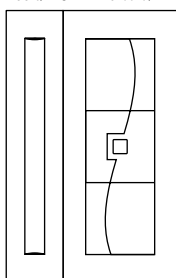

Jolly/WG1 Amarcord/W

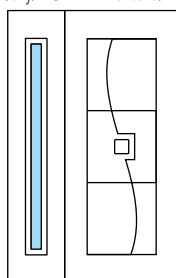

Strip/WSX Amarcord/WDX

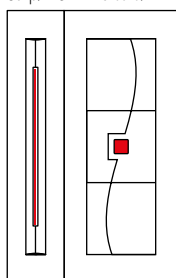

Jolly/WG1 Amarcord/WX

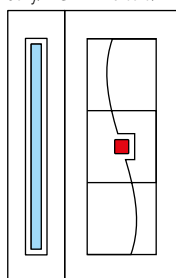

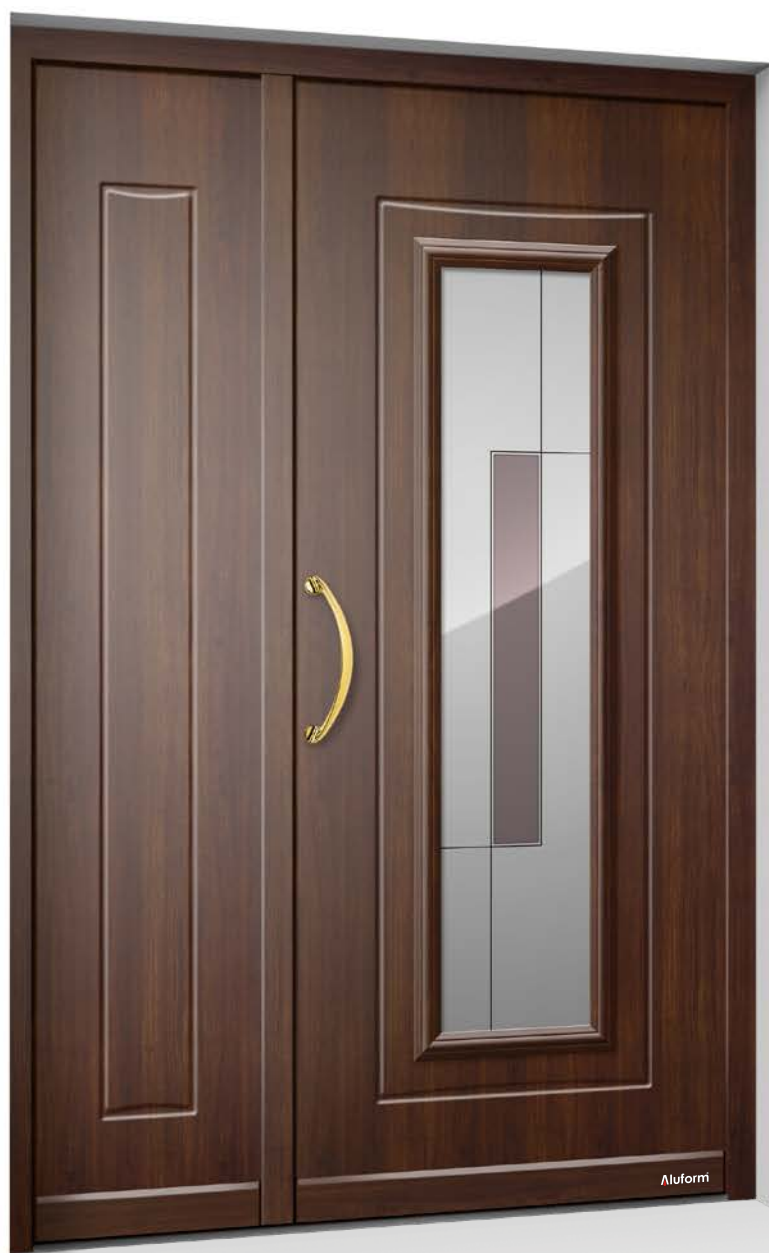

**BASIC/WS**  
Colore: Noce RP08L

**BASIC/WD1**  
Colore: Noce RP08L  
Vetro: decoro CA (38)  
Maniglia: A 407

**BASIC/W**

Colore: Avorio AK16V Grinz  
Maniglia: A 705



**JOLLY/WM1**

Colore: RAL 3003 Grinz  
Vetro: satinato A (31)  
Maniglia: A 619 (3 pezzi)



**JOLLY/WM2**

Colore: Bleu AK15V Grinz  
Cornice vetro: allum. effetto  
Inox\* - Vetro: decoro RC (31)  
Maniglia: A 619



\* Soluzione su richiesta

Basic/WS Basic/WD1

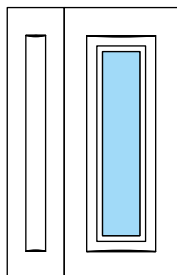

Basic/WS Basic/W

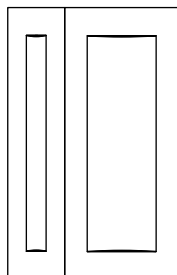

Basic/WM

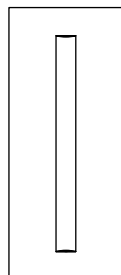

Jolly/WG1 Jolly/WM1

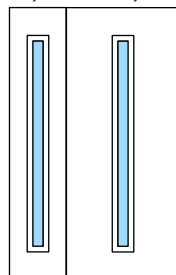

Jolly/WM2

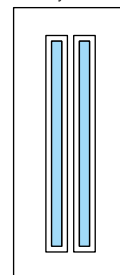

# EMOTION

COLLECTION

## LUCE/W1

Colore: Orange AK38V Grinz  
Cornice vetro: allum. effetto Inox\*  
Vetro: decoro GS (77)  
Maniglia: A 944



## LUCE/WE1

Colore: RAL 5003 Grinz  
Vetro: decoro RC (36)  
Maniglia: A 623



## LUCE/WD1

Colore: RAL 5010 Grinz  
Cornice vetro: allum. effetto Inox\*  
Vetro: decoro AC (38)  
Maniglia: A 946



Luce/WS1 Luce/W1

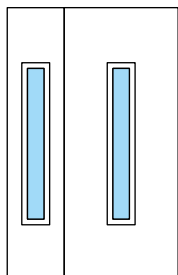

Luce/WE1

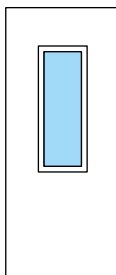

Luce/WD1

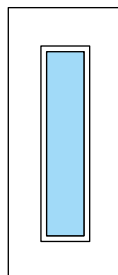

Cornice vetro  
realizzabile  
anche su misura

**LUCE/WF3**

Colore: RAL 7011 Grinz  
Cornice vetro: allum. effetto Inox\*  
Vetro: decoro FN (25)  
Maniglia: A 945



**LUCE/WH3**

Colore: Noce RP08L  
Cornice vetro: allum. effetto Inox\*  
Vetro: decoro GC (40)  
Maniglia: A 687



**LUCE/WH4**

Colore: RAL 3005 Grinz  
Cornice vetro: allum. effetto Inox\*  
Vetro: rifle (40)  
Maniglia: A 955



\* Soluzione su richiesta

Luce/WHS3 Luce/WF3

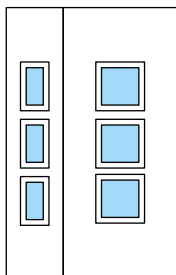

Luce/WHS3 Luce/WH3

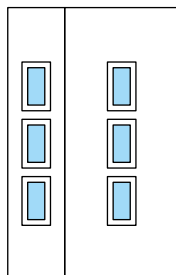

Luce/WHS4 Luce/WH4

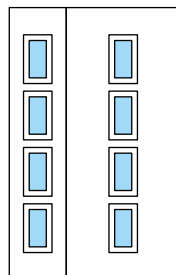

# SINTESI TECNICA

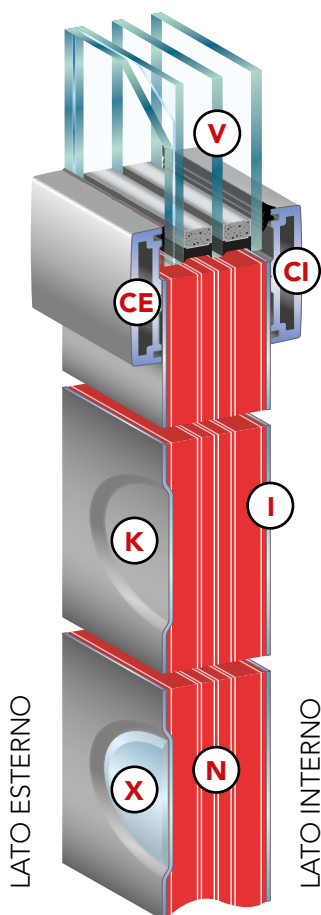

**CE - Cornice lato esterno** realizzata in alluminio estruso dello stesso colore del pannello. Su richiesta, anche di colore diverso, compresa la finitura effetto inox. Per le finiture effetto legno, vedi limitazioni alla pagina successiva.

**CI - Cornice lato interno** stesse caratteristiche e possibilità di personalizzazione della cornice sul lato esterno, può essere smontata e rimontata facilmente per l'installazione e la sostituzione del vetro.

**K - Lavorazione decorativa** di circa 2 millimetri di profondità, ricavata sulla lastra di alluminio.

**I - Lato interno liscio** realizzato di serie dello stesso colore del lato esterno. Su richiesta, colori diversi e varianti decorative come indicate sotto.

**N - Nucleo** costituito da un mix di materiali particolarmente performanti, disposti in più strati, con ottime proprietà di isolamento termico ed abbattimento acustico. Materiali e prestazioni variano in base alla tipologia e allo spessore del pannello.

**V - Vetro isolante** fornito su richiesta, realizzato con doppio o triplo vetro in base allo spessore del pannello. In entrambe le soluzioni, il vetro esterno è stratificato e quello interno temprato, in conformità alle vigenti norme sulla sicurezza. Per consentire il fissaggio della cornice interna, lo spessore del vetro deve essere inferiore di almeno 4 mm rispetto a quello del pannello.

**X - Lavorazione decorativa** di circa 2 millimetri di profondità, ricavata sulla lastra di alluminio, nella quale è incastonato l'inserto in acciaio inox AISI 316L satinato montato a filo del pannello. Su richiesta, inserto nei colori della serie Lac ed Exclusive.

**LATO ESTERNO**

**Esempio**

**LATO**

**INTERNO (di serie)**

**Liscio**

**VARIANTI**

**DECORATIVE LATO INTERNO (su richiesta)**

**Light**  
Lavorazione **K\***

**Double**  
Uguale al lato esterno



\* La lavorazione **K** riproduce sempre lo stesso disegno del modello esterno. Per i modelli senza inserti sul lato esterno, le varianti Light e Double coincidono.

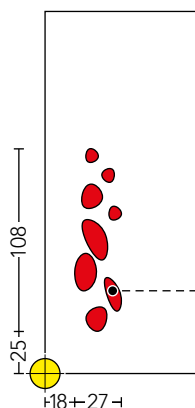

### DISEGNI E SIMBOLI

I disegni dei pannelli sono proporzionati alle dimensioni di cm 90 x 215 per l'anta principale e cm 45 x 215 per la mezza anta. Le quote indicate nei disegni (esprese in centimetri) indicano l'ingombro dell'area decorativa del modello. Con il termine area decorativa, si intende la parte lavorata del pannello che ne caratterizza il modello. L'area decorativa ha misure fisse e la sua posizione, rispetto al perimetro del pannello, può essere centrata o vincolata ad uno o più lati, quindi ad un angolo. I punti di vincolo sono indicati nei disegni con questo simbolo  (vedi figure in basso).

**Inserti.** I modelli con gli inserti sono indicati nei rispettivi disegni con la parte evidenziata in rosso.

### DIMENSIONI E SPESSORI

I pannelli sono disponibili nelle dimensioni e negli spessori indicati nell'apposito capitolo tecnico. Nella scelta del modello, valutare che l'ingombro dell'area decorativa non interferisca con il profilo perimetrale in cui è alloggiato il pannello. Il margine consigliato per garantire un buon risultato estetico, è di almeno un centimetro lungo tutto il perimetro del pannello, al netto della presa dello stesso all'interno del profilo.

**Taglio a misura.** Il taglio a misura del pannello viene eseguito su richiesta, rispettando i vincoli dell'area decorativa del modello come sopra descritti ed indicati nelle figure in basso. Per esigenze particolari, ma nei limiti consentiti dall'area decorativa e dalle dimensioni richieste, il taglio a misura può essere effettuato decentrato. L'eventuale fattibilità va richiesta tramite l'invio di un disegno quotato del modello.

### LIMITAZIONI

**Verso delle venature.** Tutti i colori effetto legno, avranno le venature disposte in senso verticale rispetto al pannello.

**Pannelli nei colori legno fuori cartella.** Saranno realizzati su richiesta presso impianti esterni. Per esigenze produttive, i pannelli con queste finiture avranno dei fori lungo i bordi verticali che ne riducono la misura utile in larghezza di circa 4 cm.

**Cornici vetro nei colori legno.** I modelli a vetri di questa collezione, realizzati nei colori effetto legno della serie Skin e Effect (compresi i rispettivi fuori cartella), saranno realizzati di serie con le cornici di forma classica (foto a fianco).

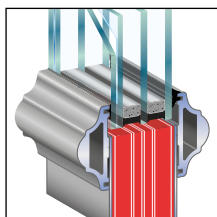

Fig. 1  
area decorativa  
centrata

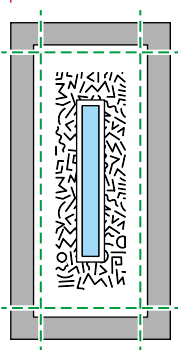

Fig. 2  
area decorativa  
vincolata in basso

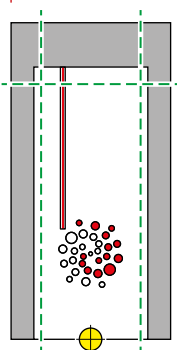
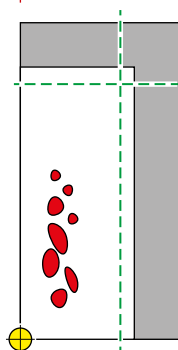
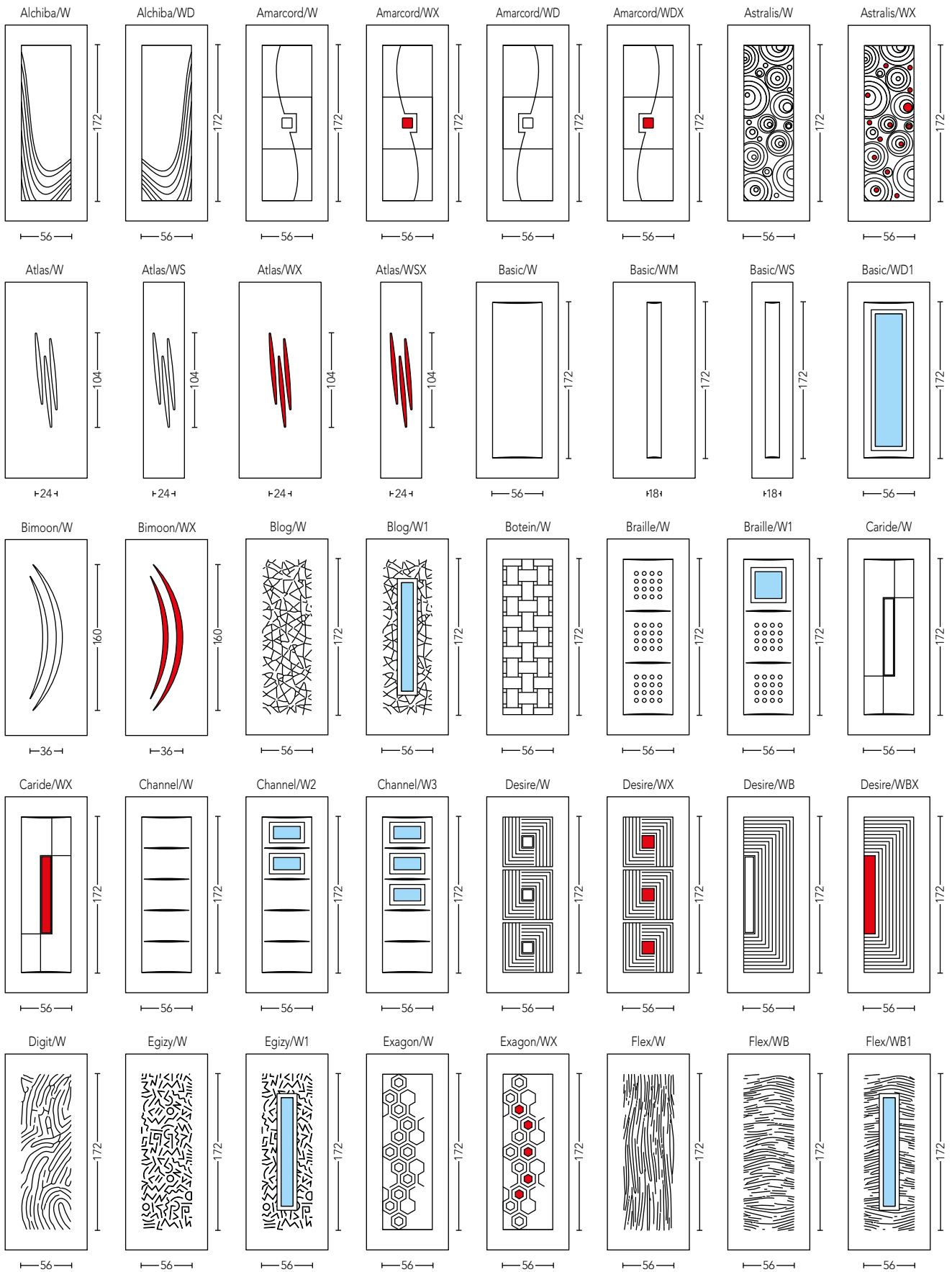

Fig. 3  
area decorativa  
vincolata agli angoli



# DISEGNI





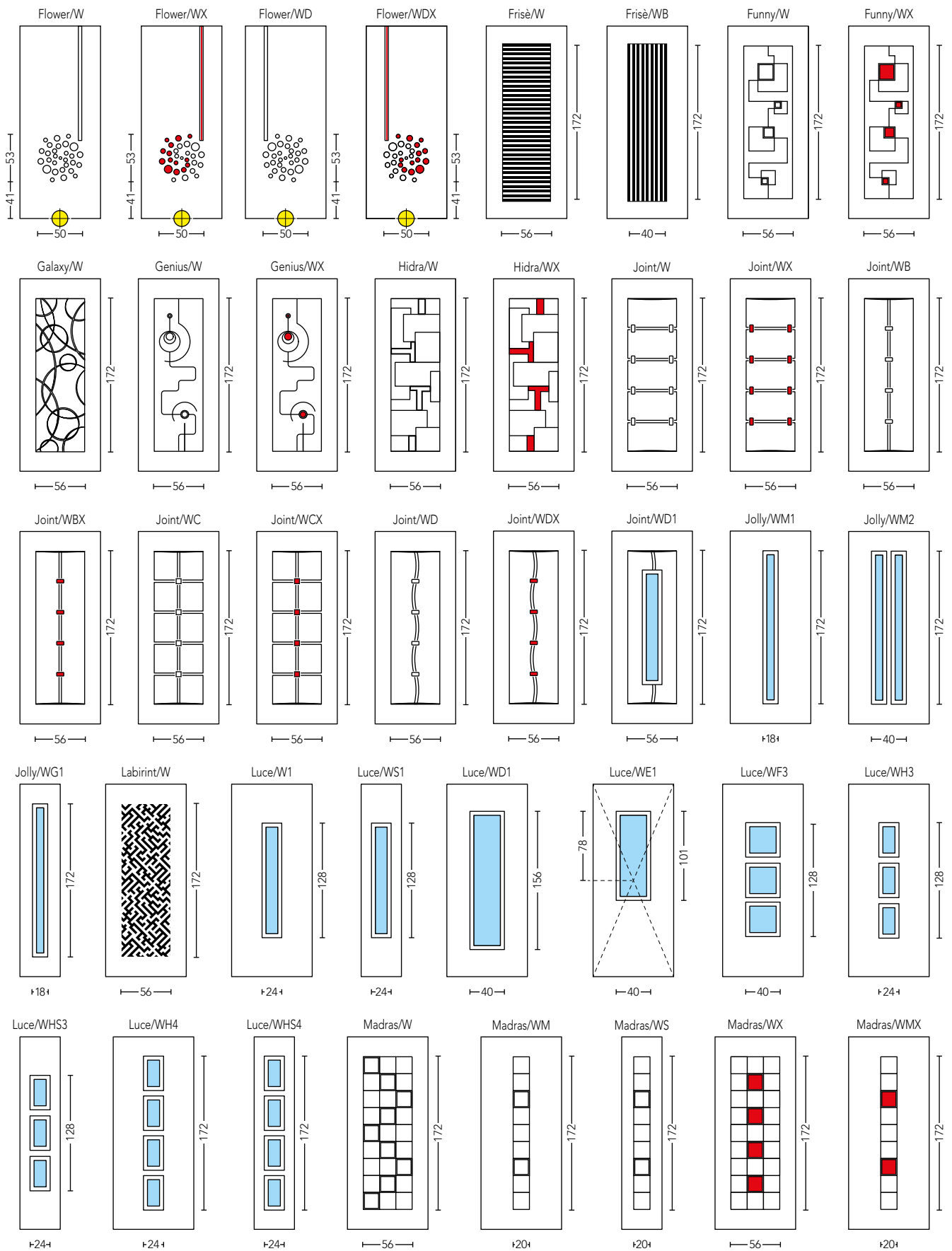

INFINITÀ

STYLE

A FILO

EMOTION

NOVECENTO

INCYSO

VETRI E DECORI

MANIGLIE

PENSILINE

COLORI

SEZ. TECNICA

# DISEGNI

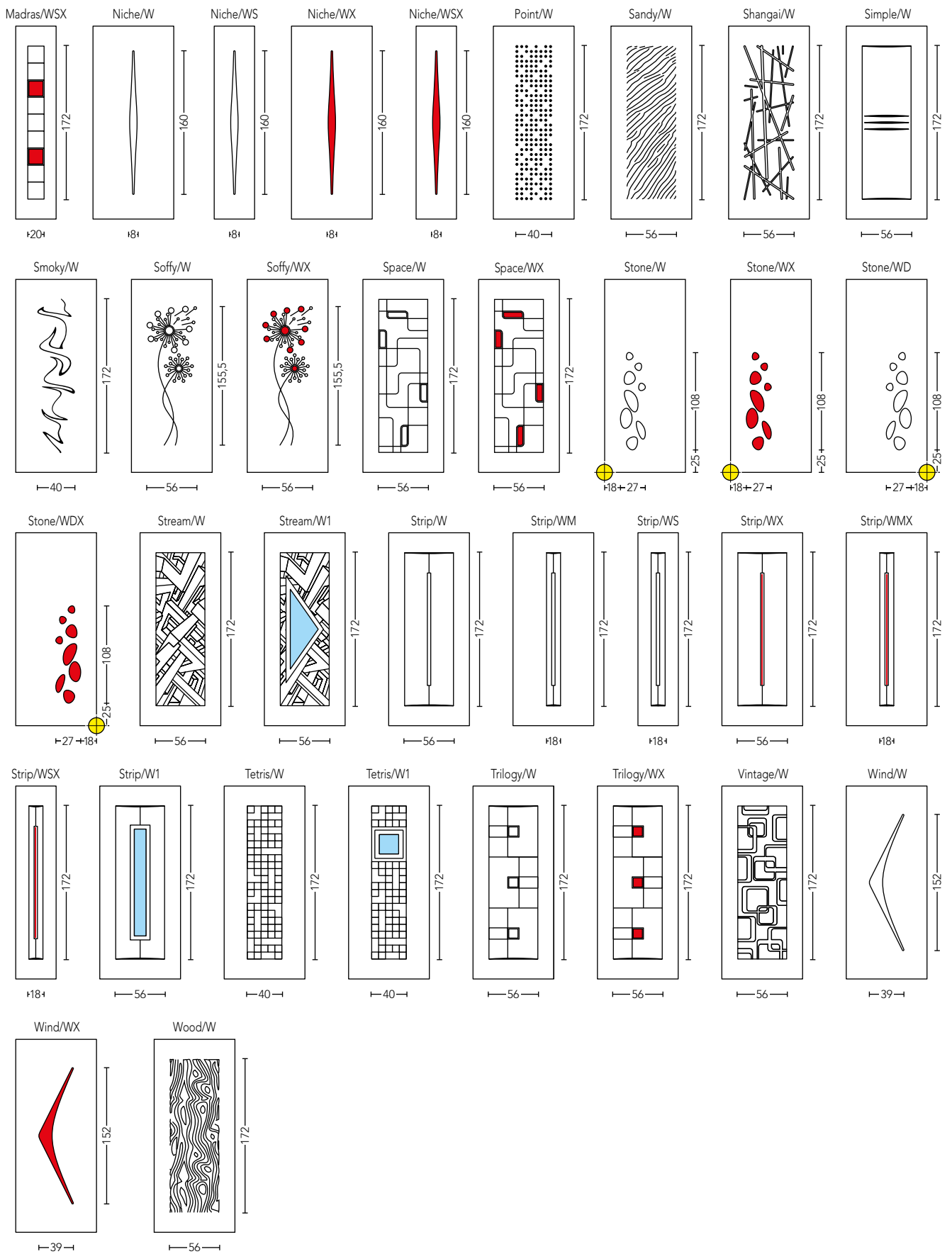







**Il lusso di scegliere un  
classico.  
Ovunque! In ogni casa!**

# NOVECENTO

Linee decise e finiture ricercate che esaltano la tradizione delle forme. Novecento è il grande classico, perfetto anche per gli spazi più contemporanei. Un design senza tempo per un ingresso che non passa mai di moda.

INFINITY

STYLE

A FILO

EMOTION

NOVECENTO

INCYSO

VETRI E DECORI

MANIGLIE

PENSILINE

COLORI

SEZ. TECNICA

# INDICE

**ABACO/K**  
Pag. 294



**NEW**  
**ABACO/K1**  
Pag. 295



**NEW**  
**ABACO/KB**  
Pag. 297



**NEW**  
**ABACO/KC**  
Pag. 296



**NEW**  
**ABACO/KM**  
Pag. 297



**ALDEBARAN/K**  
Pag. 340



**ALDEBARAN/KM**  
Pag. 341



**ALDEBARAN/K2**  
Pag. 340



**ALDEBARAN/KM1**  
Pag. 341



**NEW**  
**ALEX/KC**  
Pag. 320



**ALEX/KD**  
Pag. 320



**ALFA/K**  
Pag. 384



**ALFA/KM**  
Pag. 385



**NEW**  
**ALFA/KBM5**  
Pag. 385



**NEW**  
**ALFA/KBM3**  
Pag. 385



**ALFAIR/K**  
Pag. 338



**ALFAIR/KM**  
Pag. 339



**ALFAIR/K2**  
Pag. 339



**ALFAIR/KM1**  
Pag. 339



**ALGENIB/K**  
Pag. 375



# NOVECENTO COLLECTION

**ALGENIB/KM**  
Pag. 374



**NEW**  
**ALGENIB/K2**  
Pag. 375



**NEW**  
**ALGENIB/KM1**  
Pag. 375



**NEW**  
**ALGENIB/K6**  
Pag. 375



**NEW**  
**ALGENIB/KM3**  
Pag. 375



**ALGENIB/KB**  
Pag. 372



**ALGENIB/KC**  
Pag. 372



**ALGENIB/KD**  
Pag. 376



**ALGENIB/KE**  
Pag. 373



**ALGENIB/KE1**  
Pag. 373



**ALIZAR/K**  
Pag. 376



**ALIZAR/KM**  
Pag. 377



**NEW**  
**ANDROMEDA/K**  
Pag. 292



**NEW**  
**ANDROMEDA/K1**  
Pag. 293



**NEW**  
**ANDROMEDA/K4**  
Pag. 293



**ANTARES/K**  
Pag. 363



**ANTARES/KM**  
Pag. 363



**ANTARES/KD**  
Pag. 329



**ANTARES/KD1**  
Pag. 328



**ARIES/K**  
Pag. 391



**ARIES/KB**  
Pag. 390



**NEW**  
**ARIES/KC**  
Pag. 392



**ASTRA/K**  
Pag. 314



**AURIGA/K**  
Pag. 302



INFINITY

STYLE

A FILO

EMOTION

NOVECENTO

INCYSO

VETRI E DECORI

MANIGLIE

PENSILINE

COLORI

SEZ. TECNICA

# INDICE

**AURIGA/KB**  
Pag. 304



**NEW**  
**AURIGA/KBM**  
Pag. 303



**AURIGA/KB1**  
Pag. 304



**NEW**  
**AURIGA/KC**  
Pag. 305



**NEW**  
**AURIGA/KCM**  
Pag. 305



**BASILEO/K**  
Pag. 370



**BASILEO/K1**  
Pag. 371



**BELLATRIX/K**  
Pag. 354



**BELLATRIX/KM**  
Pag. 354



**BELLATRIX/K1**  
Pag. 354



**BELLATRIX/KM1**  
Pag. 354



**BELLATRIX/K3**  
Pag. 355



**BELLATRIX/KM2**  
Pag. 355



**BELLATRIX/K5**  
Pag. 355



**BELLATRIX/KM3**  
Pag. 355



**CASSIOPEA/K**  
Pag. 317



**CASTORE/K**  
Pag. 386



**CASTORE/K1**  
Pag. 386



**NEW**  
**DENEB/K**  
Pag. 388



**NEW**  
**DERUTA/K**  
Pag. 306



**NEW**  
**DERUTA/KB**  
Pag. 307



**DORADO/K**  
Pag. 387



**DORADO/K1**  
Pag. 387



**ECHO/K**  
Pag. 316





# NOVECENTO COLLECTION

**ELISIR/K**  
Pag. 318



**ELISIR/KB**  
Pag. 319



**NEW**  
**ELISIR/KC**  
Pag. 319



**ERIDANO/K**  
Pag. 378



**ERIDANO/KM**  
Pag. 378



**ERIDANO/K2**  
Pag. 378



**ERIDANO/KM1**  
Pag. 379



**ERIDANO/K6**  
Pag. 379



**ERIDANO/KM3**  
Pag. 379



**ERMES/K**  
Pag. 298



**ERMES/K1**  
Pag. 299



**NEW**  
**ERMES/KB**  
Pag. 300



**NEW**  
**ERMES/KB1**  
Pag. 300



**NEW**  
**ERMES/KC**  
Pag. 301



**GEMINI/K**  
Pag. 343



**GEMINI/K1**  
Pag. 342



**GEMMA/K**  
Pag. 347



**GEMMA/K1**  
Pag. 346



**GEO/K**  
Pag. 344



**GEO/K1**  
Pag. 344



**NEW**  
**GRADARA/K**  
Pag. 366



**NEW**  
**GRADARA/KB**  
Pag. 367



**NEW**  
**GRADARA/KB1**  
Pag. 367



**IKARO/K**  
Pag. 324



INFINITY

STYLE

A FILO

EMOTION

NOVECENTO

INCYSO

VETRI E DECORI

MANIGLIE

PENSILINE

COLORI

SEZ. TECNICA

# INDICE

**IKARO/K1**  
Pag. 325



**IKARO/KB1**  
Pag. 325



**IRIS/K**  
Pag. 364



**IRIS/K1**  
Pag. 365



**IRIS/K3**  
Pag. 365



**IRIS/KC1**  
Pag. 365



**NEW**  
**JOLLY/KBGM**  
Pag. 392



**NEW**  
**JOLLY/KGM**  
Pag. 393



**NEW**  
**JOLLY/KGM1**  
Pag. 393



**NEW**  
**JOLLY/KGM2**  
Pag. 393



**KALIPSO/KD**  
Pag. 321



**NEW**  
**KALIPSO/KM**  
Pag. 321



**KLIO/K**  
Pag. 308



**KLIO/KB**  
Pag. 309



**KLIO/KD**  
Pag. 308



**NEW**  
**KLIO/KM**  
Pag. 309



**LIBRA/K**  
Pag. 352



**LIBRA/KB**  
Pag. 353



**LIBRA/K1**  
Pag. 353



**NEW**  
**LUCE/K1**  
Pag. 394



**NEW**  
**LUCE/KD1**  
Pag. 394



**NEW**  
**LUCE/KE1**  
Pag. 394



**NEW**  
**LUCE/KF3**  
Pag. 395

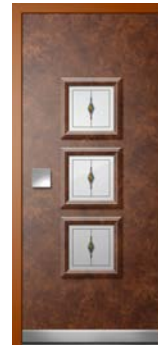

**NEW**  
**LUCE/KH3**  
Pag. 395



# NOVECENTO COLLECTION

NEW

**LUCE/KH4**  
Pag. 395



**MINERVA/K**  
Pag. 351



**MINERVA/KM**  
Pag. 351



**MINERVA/K1**  
Pag. 350



**MINERVA/KM1**  
Pag. 351



**MIRA/K**  
Pag. 380



**MIRA/KM**  
Pag. 380



**MIRA/K2**  
Pag. 380



**MIRA/KM1**  
Pag. 380



**MIRA/K4**  
Pag. 381



**MIRA/KM2**  
Pag. 381



**MIRA/K6**  
Pag. 381



**MIRA/KM3**  
Pag. 381



**MIRANDA/K**  
Pag. 356



**MIRANDA/K1**  
Pag. 356



**MIRANDA/K2**  
Pag. 356



**MIRANDA/K3**  
Pag. 357



**MIRANDA/KB**  
Pag. 357



**MIRANDA/KB1**  
Pag. 357



**MIZAR/K**  
Pag. 377



**MIZAR/KM**  
Pag. 377



**PALLADIO/K**  
Pag. 326



**PALLADIO/K1**  
Pag. 327



**PEGASO/K**  
Pag. 322



INFINITY

STYLE

A FILO

EMOTION

NOVECENTO

INCYSO

VETRI E DECORI

MANIGLIE

PENSILINE

COLORI

SEZ. TECNICA

# INDICE

**PEGASO/KB**  
Pag. 322



**PEGASO/KM**  
Pag. 323



**PERSEO/K**  
Pag. 345



**PERSEO/K1**  
Pag. 345



**POLARIS/K**  
Pag. 310



**POLARIS/K1**  
Pag. 311



**POLARIS/K2**  
Pag. 311



**QUASAR/K**  
Pag. 348



**QUASAR/K1**  
Pag. 348



**NEW**  
**QUASAR/KB**  
Pag. 349



**NEW**  
**QUASAR/KB3**  
Pag. 349



**NEW**  
**QUATER/K**  
Pag. 368



**NEW**  
**QUATER/KM**  
Pag. 369



**NEW**  
**QUATER/K4**  
Pag. 369



**REGOLO/KA**  
Pag. 333



**REGOLO/KA1**  
Pag. 332



**REGOLO/KB**  
Pag. 334



**REGOLO/KBM**  
Pag. 334



**REGOLO/KC**  
Pag. 333



**REGOLO/KD**  
Pag. 335



**REGOLO/KD1**  
Pag. 335



**REGOLO/KDM1**  
Pag. 335



**RIGEL/K**  
Pag. 337



**RIGEL/KM**  
Pag. 337



# NOVECENTO COLLECTION

**RIGEL/KB**  
Pag. 336



**RIGEL/K2**  
Pag. 337



**RIGEL/KM1**  
Pag. 337



**NEW**  
**SIGMA/K**  
Pag. 389



**NEW**  
**SIGMA/K1**  
Pag. 389



**SIRIO/K**  
Pag. 330



**SIRIO/K1**  
Pag. 330



**SIRIO/KC**  
Pag. 331



**SIRIO/KE**  
Pag. 331



**STILUS/K**  
Pag. 312



**STILUS/K1**  
Pag. 312



**TITANO/K**  
Pag. 382



**TITANO/KM**  
Pag. 383



**TITANO/K2**  
Pag. 383



**TITANO/KM1**  
Pag. 383



**TRIADE/K**  
Pag. 358



**TRIADE/K1**  
Pag. 359



**TRIADE/KB**  
Pag. 362



**NEW**  
**TRIADE/KBM**  
Pag. 362



**NEW**  
**TRIADE/KC**  
Pag. 360



**NEW**  
**TRIADE/KC1**  
Pag. 361



**URANIA/K**  
Pag. 323



**VICTORIA/K**  
Pag. 313



**VICTORIA/K1**  
Pag. 313



INFINITY

STYLE

A FILO

EMOTION

NOVECENTO

INCYSO

VETRI E DECORI

MANIGLIE

PENSILINE

COLORI

SEZ. TECNICA

**NOVECENTO**  
COLLECTION



**JOLLY/KG**  
Colore: Ciliegio RP03L

**ANDROMEDA/K**  
Colore: Ciliegio RP03L  
Maniglia: A 418  
Battente: A 440

**ANDROMEDA/K1**

Colore: RAL 8014 Grinz  
Cornice vetro: RAL 7044 Grinz\*  
Vetro: decoro FN (38)  
Maniglia: A 518



**ANDROMEDA/K4**

Colore: RAL 8019 Grinz  
Vetro: decoro GC (26)  
Maniglia: A 318



INFINITY

STYLE

A FILO

EMOTION

**NOVECENTO**

INCYSO

VETRI E DECORI

MANIGLIE

PENSILINE

COLORI

SEZ. TECNICA

\* Soluzione su richiesta

Jolly/KG Andromeda/K

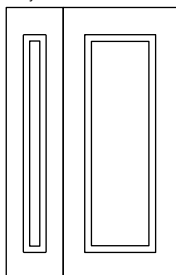

Andromeda/K1

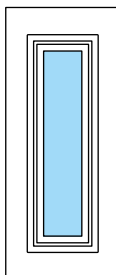

Andromeda/K4

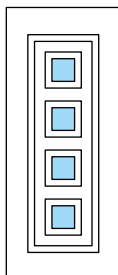

Grata Inox GI\*



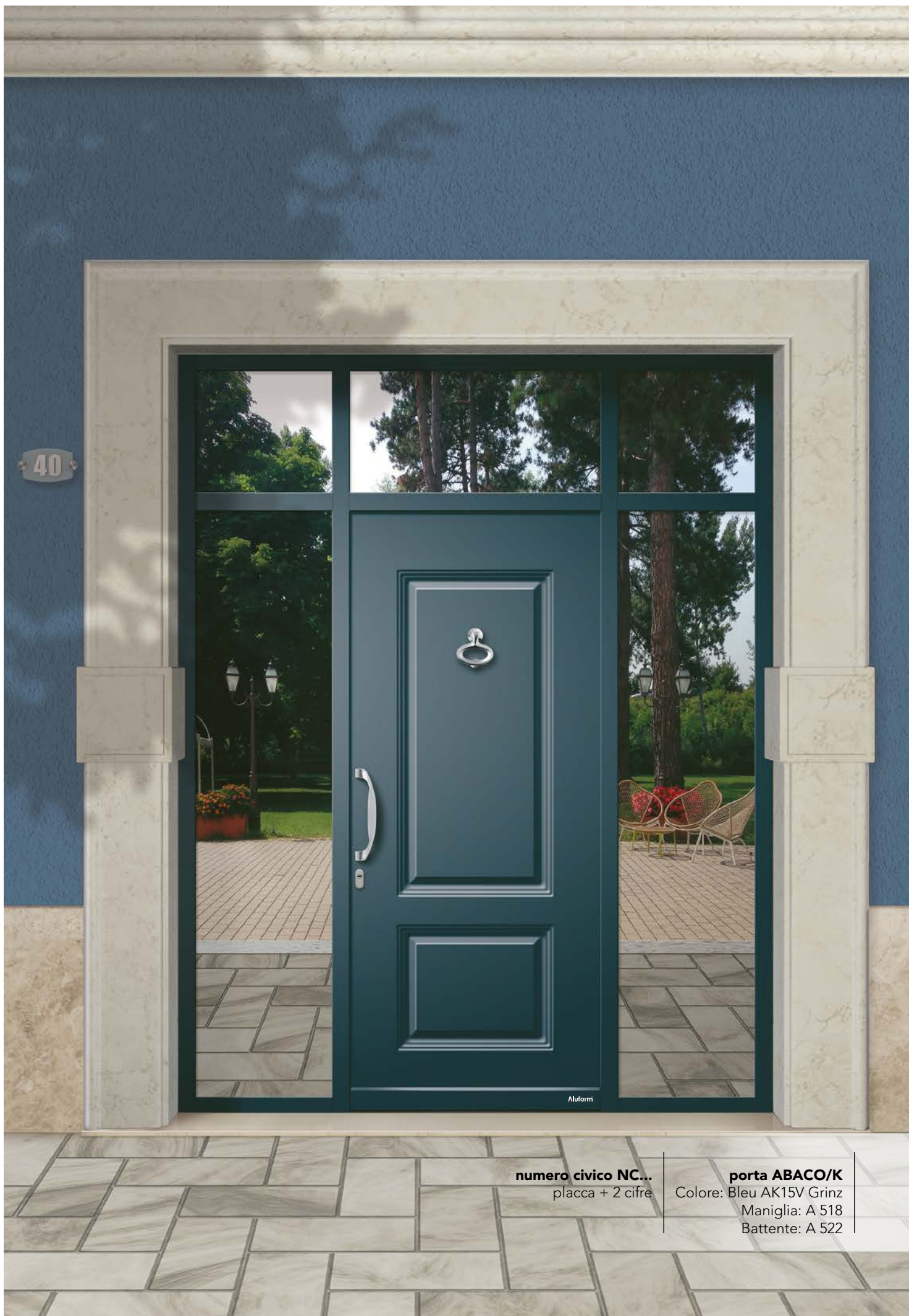

numero civico NC...  
placca + 2 cifre

porta **ABACO/K**  
Colore: Bleu AK15V Grinz  
Maniglia: A 518  
Battente: A 522



**ABACO/KS**

Colore:  
RAL 6005 Grinz

**ABACO/K**

Colore: RAL 6005 Grinz  
Maniglia: A 518

**ABACO/K1**

Colore: RAL 7005 Grinz  
Vetro: decoro FN (36)  
Maniglia: A 318



\* Soluzione su richiesta

Abaco/KS    Abaco/K

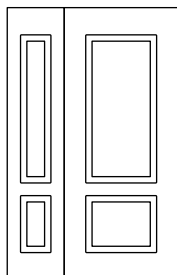

Jolly/KG1    Abaco/K1

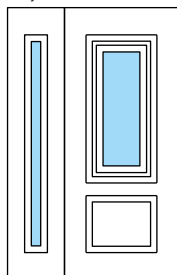

Grata Inox GI\*



**NOVECENTO**  
COLLECTION



**ABACO/KC**  
Colore: Noce RP08L  
Maniglia: A 407

**ABACO/KM**

Colore: Corten V001V Grinz Mix  
Maniglia: A 409



**ABACO/KB**

Colore: RAL 7006 Grinz  
Maniglia: A 509  
Battente: A 540



Abaco/KS    Abaco/KC

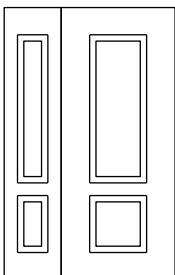

Abaco/KM

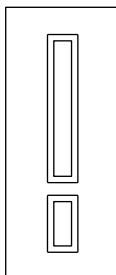

Jolly/KG1    Abaco/KB

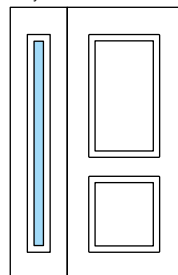

INFINITY

STYLE

A FILO

EMOTION

**NOVECENTO**

INCYSO

VETRI E DECORI

MANIGLIE

PENSILINE

COLORI

SEZ. TECNICA



**pensilina OLDSTYLE Mod. OS-01**  
Colore: struttura Antracite P016V Grinz  
Copertura: Neutro satinato

**porta ERMES/K**  
Colore: RAL 7030 Grinz  
Maniglia: A 417  
Battente: A 420

**ERMES/K**

Colore: RAL 8014 Grinz  
Maniglia: A 507  
Battente: A 520



**ERMES/K1**

Colore: Ambra AK40V Grinz  
Vetro: decoro AC (34)  
Maniglia: A 507



INFINITY

STYLE

A FILO

EMOTION

**NOVECENTO**

INCYSO

VETRI E DECORI

MANIGLIE

PENSILINE

COLORI

SEZ. TECNICA

\* Soluzione su richiesta

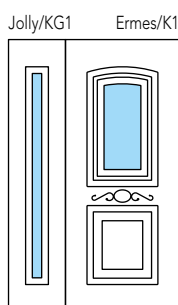
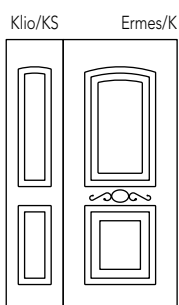

# NOVECENTO

COLLECTION

## ERMES/KB

Colore: RAL 1019 Grinz  
Maniglia: A 417  
Battente: A 420



## ERMES/KB1

Colore: RAL 8011 Grinz  
Vetro: decoro GS (34)  
Grata in acciaio Inox GI\*  
Maniglia: A 517



\* Soluzione su richiesta

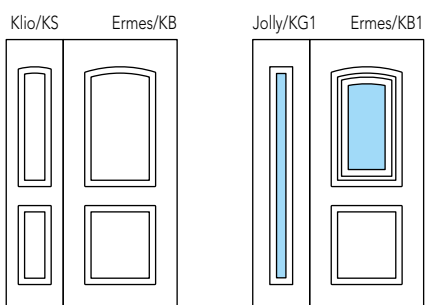

**ERMES/KC**

Colore: Noce RP05L

Maniglia: A 506

Battente: A 525



Abaco/KS    Ermes/KC

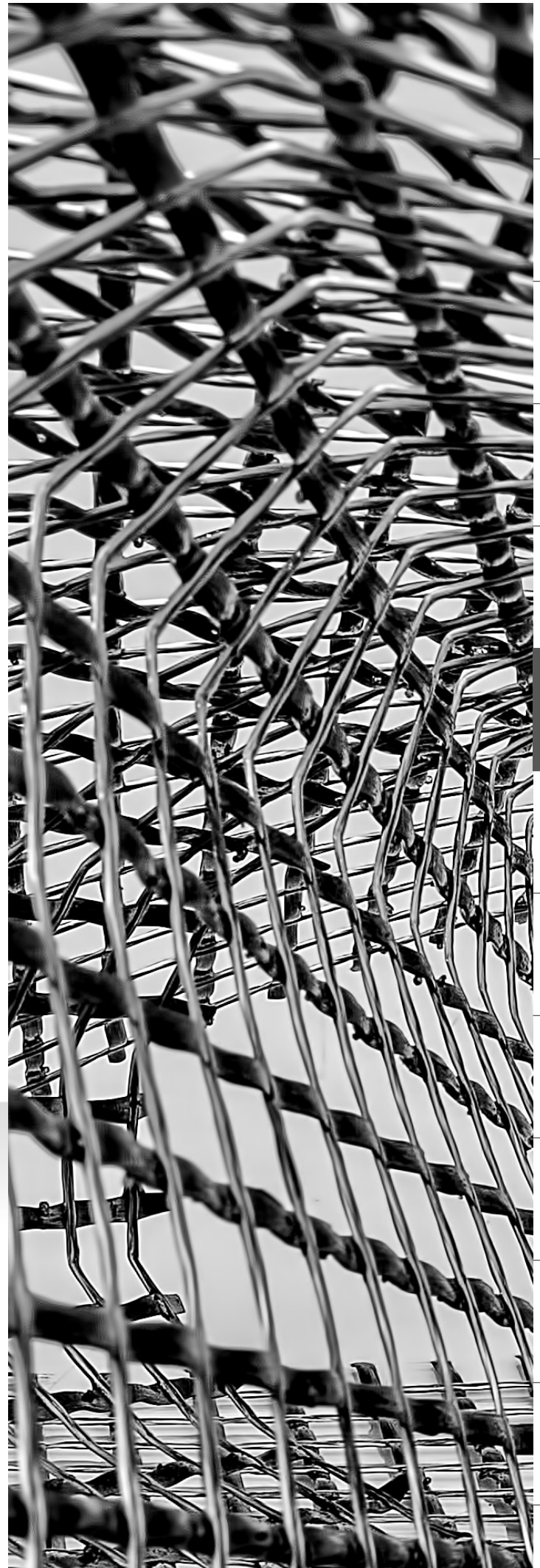
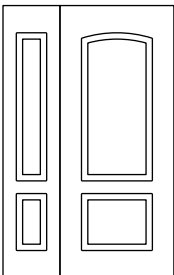

INFINITY

STYLE

A FILO

EMOTION

**NOVECENTO**

INCYSO

VETRI E DECORI

MANIGLIE

PENSILINE

COLORI

SEZ. TECNICA



**AURIGA/K**

Colore: Verde P7100 Mix

Maniglia: A 414

Battente: A 420



**AURIGA/K**

Colore: RAL 7011 Grinz  
Maniglia: A 570  
Battente: A 520



**AURIGA/KBM**

Colore: RAL 7016 Grinz  
Maniglia: A 507



INFINITY

STYLE

A FILO

EMOTION

**NOVECENTO**

INCYSO

VETRI E DECORI

MANIGLIE

PENSILINE

COLORI

SEZ. TECNICA

Jolly/KG1    Auriga/K

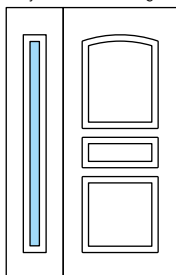

Jolly/KG    Auriga/K

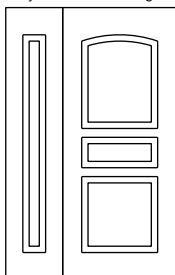

Auriga/KBM

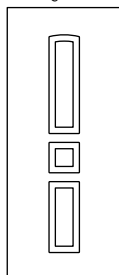

# NOVECENTO

COLLECTION

## AURIGA/KB

Colore: RAL 7038 Grinz

Maniglia: A 518

Battente: A 522



## AURIGA/KB1

Colore: RAL 7032 Grinz

Vetro: decoro GS (33)

Maniglia: A 418



Auriga/KBS Auriga/KB

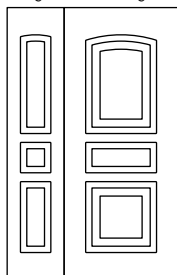

Jolly/KG1 Auriga/KB1

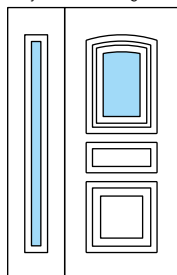

Grata Inox GI\*



**AURIGA/KC**

Colore: Verde P7100 Mix  
Maniglia: A 414  
Battente: A 420

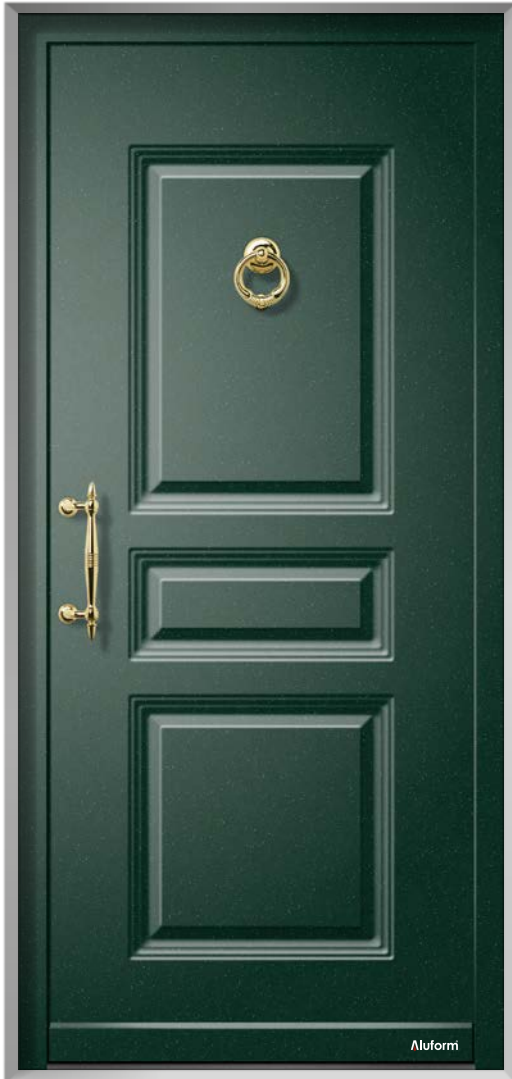

**AURIGA/KCM**

Colore: RAL 6009 Grinz  
Maniglia: A 514



INFINITY

STYLE

A FILO

EMOTION

**NOVECENTO**

INCYSO

VETRI E DECORI

MANIGLIE

PENSILINE

COLORI

SEZ. TECNICA

\* Soluzione su richiesta

Auriga/KCS Auriga/KC

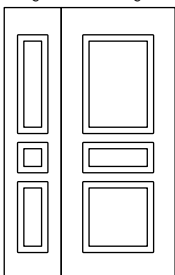

Auriga/KCM

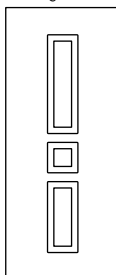

**NOVECENTO**  
COLLECTION



**AURIGA/KBS**  
Colore: RAL 3005 Grinz

**DERUTA/K**  
Colore: RAL 3005 Grinz  
Maniglia: A 509  
Battente: A 540

**DERUTA/K**

Colore: RAL 8019 Grinz  
Maniglia: A 946



**DERUTA/KB**

Colore: Bleu AK15V Grinz  
Maniglia: A 507



INFINITY

STYLE

A FILO

EMOTION

**NOVECENTO**

INCYSO

VETRI E DECORI

MANIGLIE

PENSILINE

COLORI

SEZ. TECNICA

Auriga/KBS Deruta/K

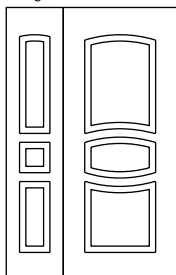

Jolly/KG1 Deruta/K

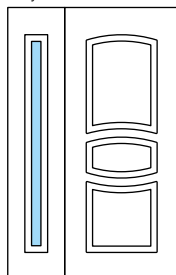

Auriga/KBS Deruta/KB

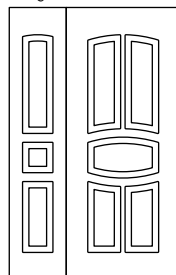

**NOVECENTO**  
COLLECTION

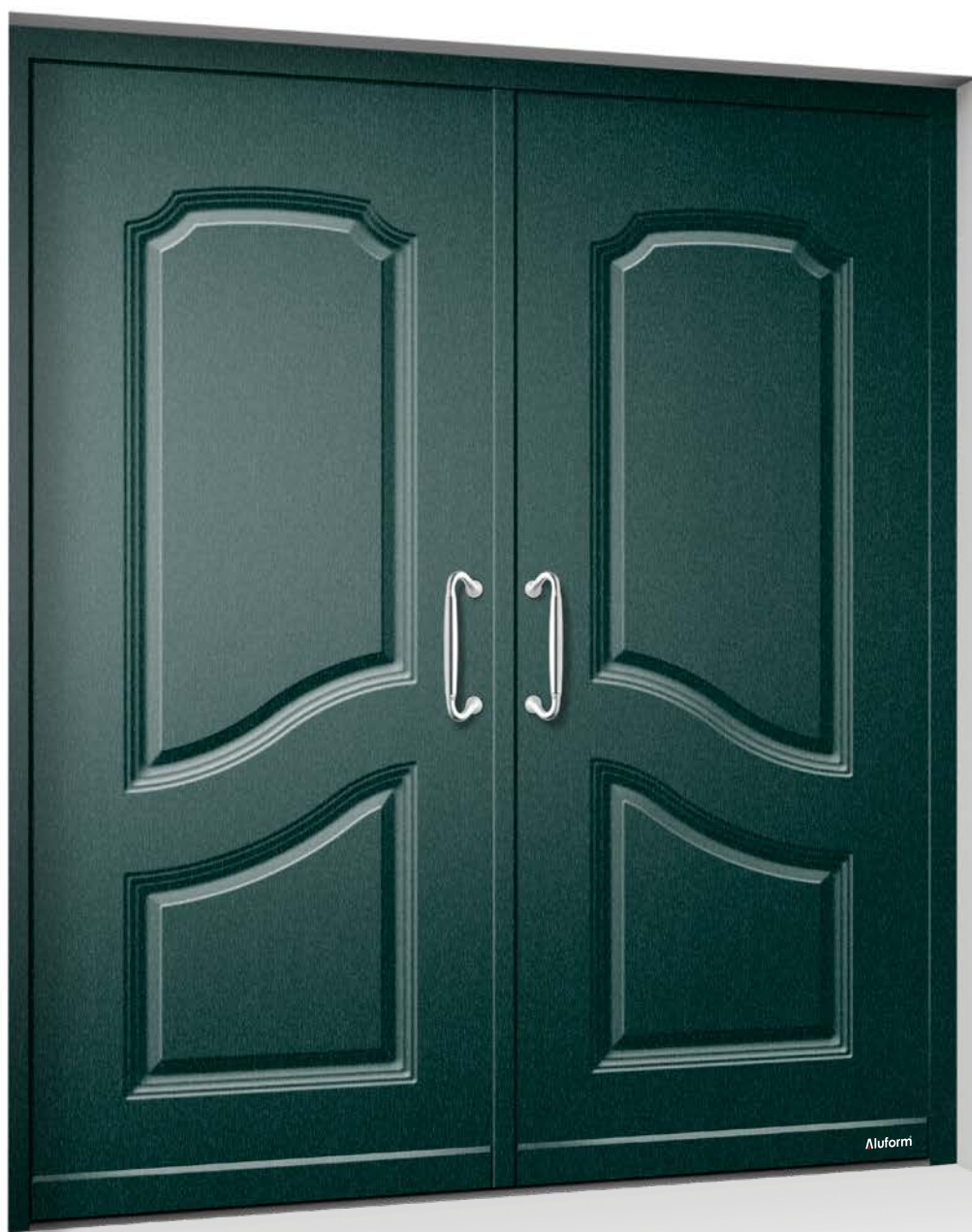

**KLIO/K**

Colore: Dunkelgrun 6125 11.61.09-167  
Maniglia: A 506

**KLIO/KD**

Colore: Dunkelgrun 6125 11.61.09-167  
Maniglia: A 506

**KLIO/KB**

Colore: Bleu AK15V Grinz  
Maniglia: A 506  
Battente: A 525



**KLIO/KM**

Colore: Noce RP05L  
Maniglia: A 406



Klio/K

Klio/KS

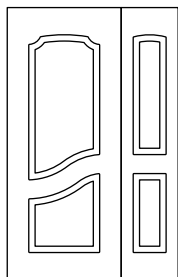

Jolly/KG1

Klio/KB

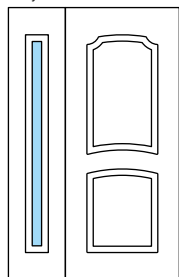

Klio/KS

Klio/KD

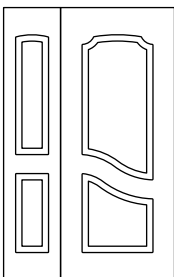

Klio/KM

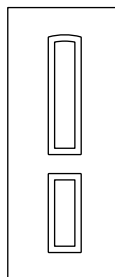

INFINITY

STYLE

A FILO

EMOTION

NOVECENTO

INCYSO

VETRI E DECORI

MANIGLIE

PENSILINE

COLORI

SEZ. TECNICA

**NOVECENTO**  
COLLECTION



**JOLLY/KG1**

Colore: RAL 7005 Grinz  
Vetro: decoro RC (31)

**POLARIS/K**

Colore: RAL 7005 Grinz  
Maniglia: A 414



**POLARIS/K1**

Colore: RAL 7011 Grinz  
Vetro: decoro GC (27)  
Maniglia: A 314



**POLARIS/K2**

Colore: RAL 7016 Grinz  
Vetro: decoro GS (27-26)  
Maniglia: A 514



INFINITY

STYLE

A FILO

EMOTION

**NOVECENTO**

INCYSO

VETRI E DECORI

MANIGLIE

PENSILINE

COLORI

SEZ. TECNICA

Jolly/KG      Polaris/K

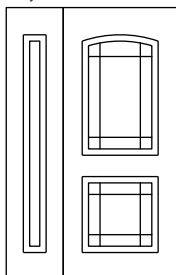

Jolly/KG1      Polaris/K1

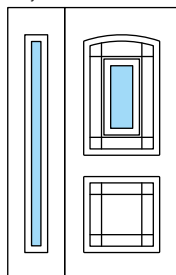

Jolly/KG1      Polaris/K2

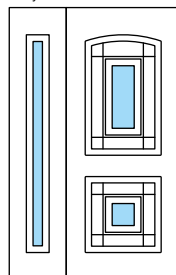

# NOVECENTO

COLLECTION

## STILUS/K

Colore: Grigio P7000 Mix  
Maniglia: A 415



## STILUS/K1

Colore: Grigio P7003 Grinz Mix  
Vetro: decoro AC (16)  
Maniglia: A 515



Jolly/KG      Stilus/K

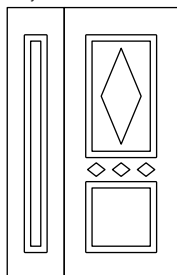

Jolly/KG1      Stilus/K1

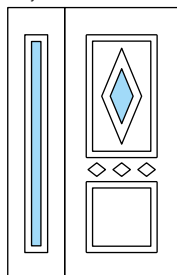

**VICTORIA/K**

Colore: RAL 9007 Grinz  
Maniglia: A 682



**VICTORIA/K1**

Colore: RAL 7035 Grinz  
Vetro: decoro FN (22)  
Maniglia: A 961



INFINITY

STYLE

A FILO

EMOTION

**NOVECENTO**

INCYSO

VETRI E DECORI

MANIGLIE

PENSILINE

COLORI

SEZ. TECNICA

\* Soluzione su richiesta

Jolly/KG    Victoria/K

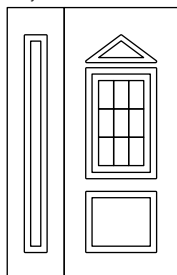

Jolly/KG1    Victoria/K1

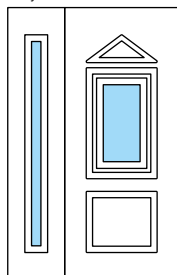

Grata Inox GI\*





Aluform

**ASTRA/K**

Colore: RAL 9010 Grinz

Maniglia: A 417

**ASTRA/K**

Colore: RAL 7011 Grinz  
Pomo: A 430



**ASTRA/K**

Colore: RAL 6009 Grinz  
Maniglia: A 517



INFINITY

STYLE

A FILO

EMOTION

**NOVECENTO**

INCYSO

VETRI E DECORI

MANIGLIE

PENSILINE

COLORI

SEZ. TECNICA

Klio/KS      Astra/K

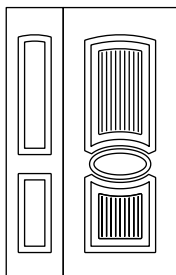

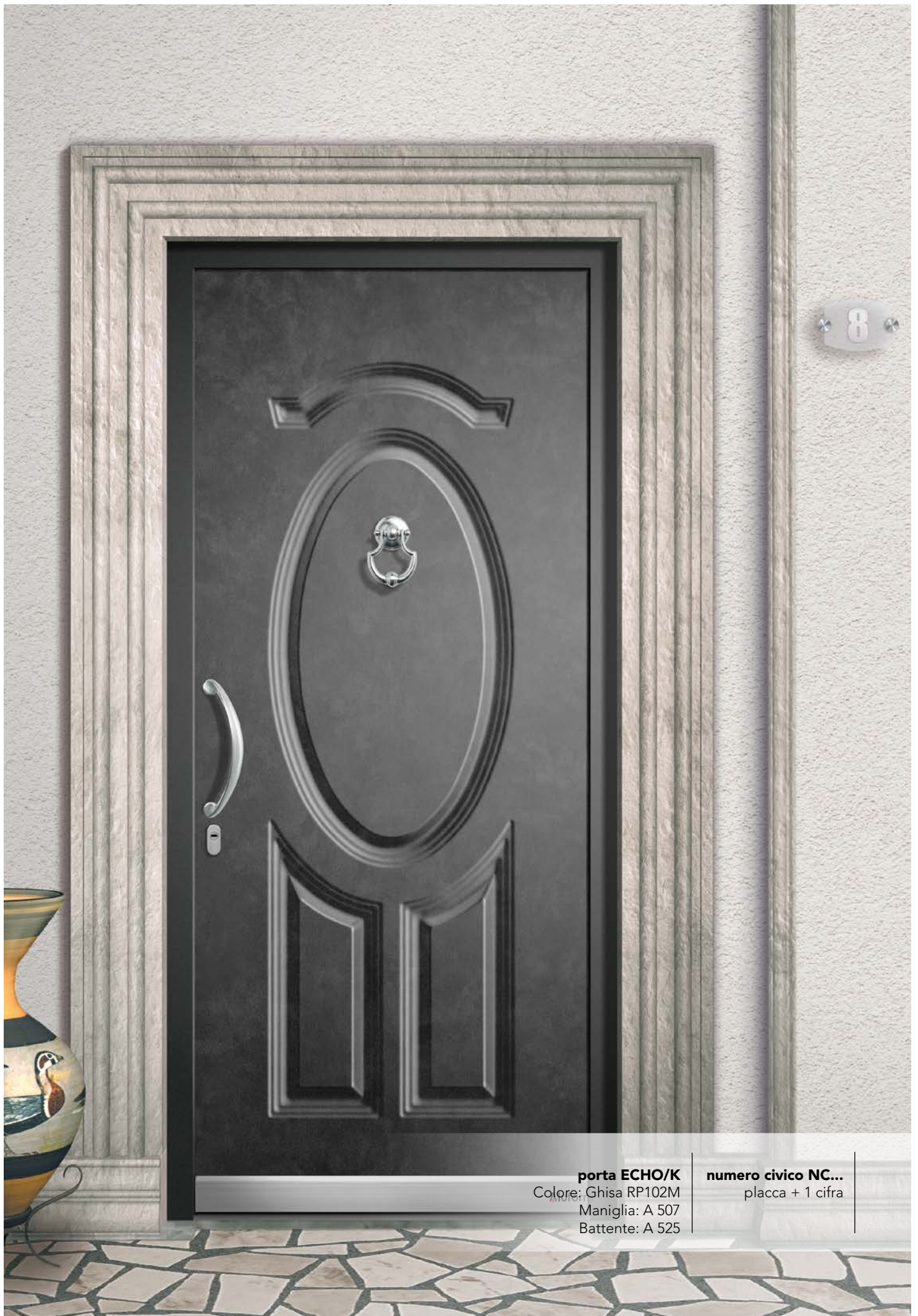

**porta ECHO/K**

Colore: Ghisa RP102M

Maniglia: A 507

Battente: A 525

**numero civico NC...**

placca + 1 cifra

**ECHO/K**

Colore: Noce RP05L  
Maniglia: A 407  
Battente: A 425



**CASSIOPEA/K**

Colore: RAL 7006 Grinz  
Maniglia: A 507



INFINITY

STYLE

A FILO

EMOTION

**NOVECENTO**

INCYSO

VETRI E DECORI

MANIGLIE

PENSILINE

COLORI

SEZ. TECNICA

Jolly/KG Echo/K

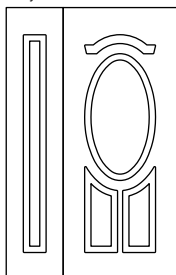

Jolly/KG1 Cassiopea/K

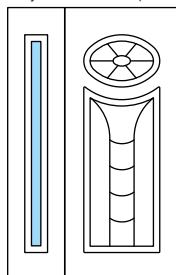



Aluform

**ELISIR/K**

Colore: Ciliegio RP03L

Maniglia: A 418

Battente: A 422



**ELISIR/KB**

Colore: Bronzo TR03V Grinz  
Pomo: A 430

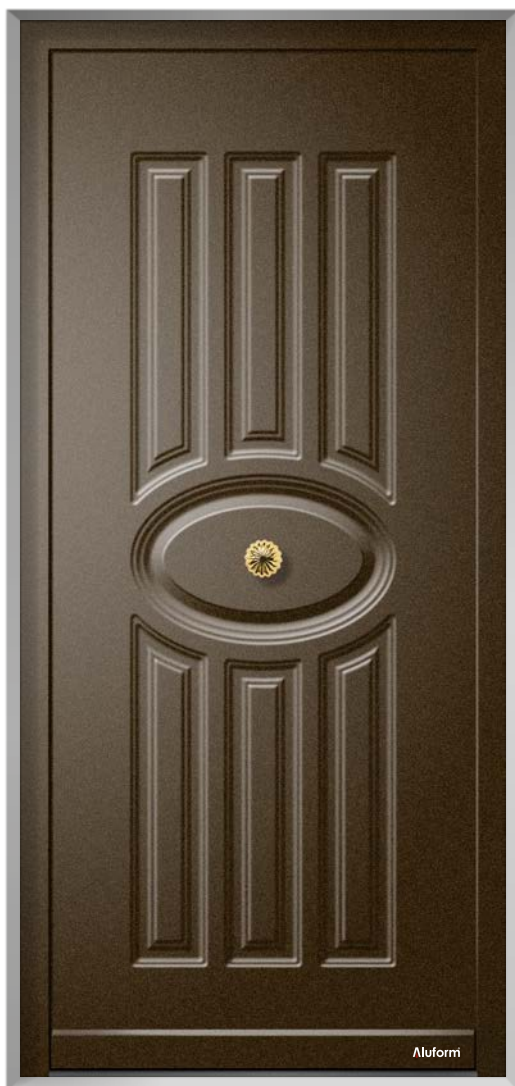

**ELISIR/KC**

Colore: RAL 7035 Grinz  
Maniglia: A 518  
Battente: A 522



INFINITY

STYLE

A FILO

EMOTION

**NOVECENTO**

INCYSO

VETRI E DECORI

MANIGLIE

PENSILINE

COLORI

SEZ. TECNICA

Jolly/KG      Elisir/K

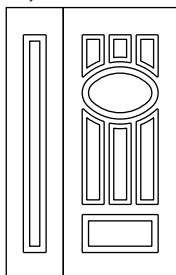

Jolly/KBG      Elisir/KB

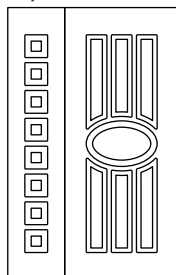

Jolly/KG      Elisir/KC

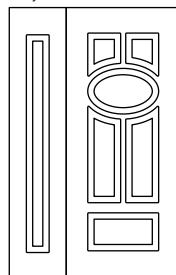

# NOVECENTO

COLLECTION

## ALEX/KD

Colore: Ambra AK40V Grinz  
Maniglia: A 407

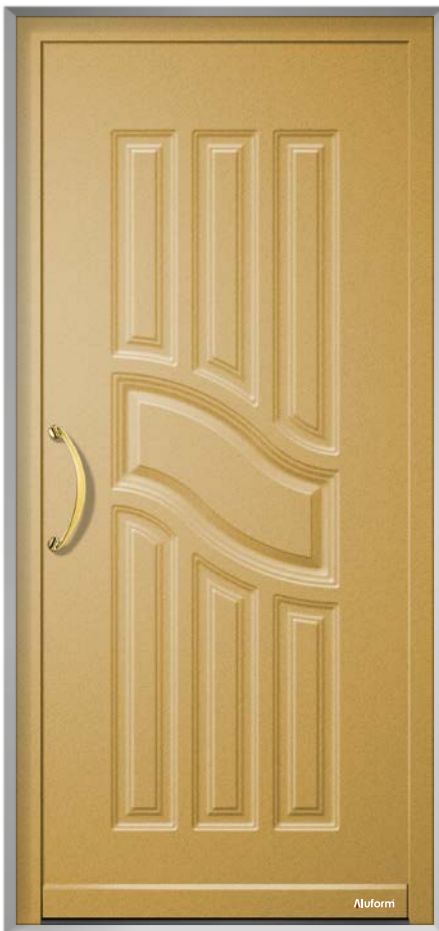

## AURIGA/KCS

Colore: Marrone  
P7200 Mix

## ALEX/KC

Colore: Marrone P7200 Mix  
Maniglia: A 518  
Battente: A 522



Alex/K Jolly/KG1

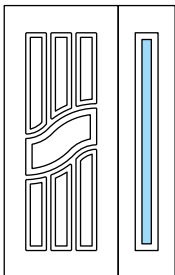

Jolly/KG Alex/KD

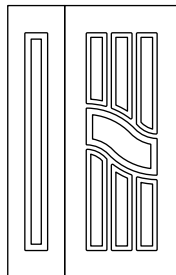

Auriga/KCS Alex/KB

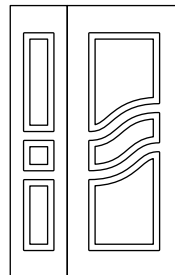

Auriga/KCS Alex/KC

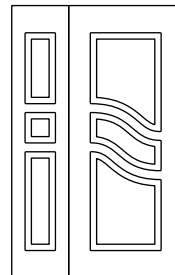

**KALIPSO/KB**

Colore: RAL 6009 Grinz  
Maniglia: A 406

**KALIPSO/KC**

Colore: RAL 6009 Grinz  
Maniglia: A 406

**KALIPSO/KD**

Colore: Rovere grigio RP10L  
Maniglia: A 506



INFINITY

STYLE

A FILO

EMOTION

**NOVECENTO**

INCYSO

VETRI E DECORI

MANIGLIE

PENSILINE

COLORI

SEZ. TECNICA

Kalipso/KB

Kalipso/KC

Kalipso/K

Kalipso/KS

Kalipso/KD

Kalipso/KM

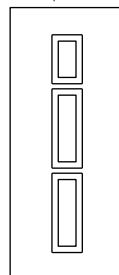
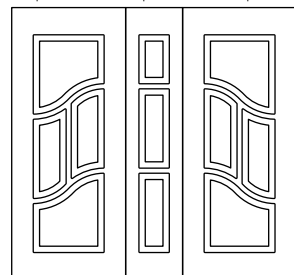
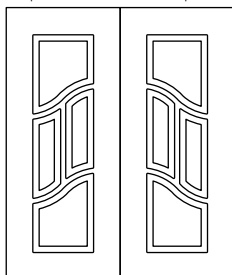

# NOVECENTO

COLLECTION

## PEGASO/K

Colore: RAL 7032 Grinz  
Maniglia: A 416



## PEGASO/KB

Colore: RAL 7030 Grinz  
Maniglia: A 946



Jolly/K1 Pegaso/K

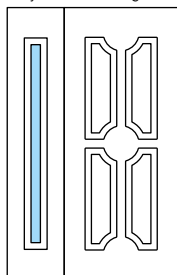

Jolly/KG Pegaso/KB

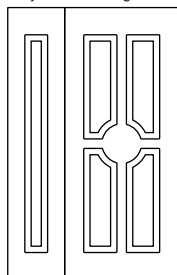

**PEGASO/KM**

Colore: RAL 9007 Grinz  
Pomo: A 530



**URANIA/K**

Colore: Grigio P7003 Grinz Mix  
Maniglia: A 516  
Battente: A 520



INFINITY

STYLE

A FILO

EMOTION

**NOVECENTO**

INCYSO

VETRI E DECORI

MANIGLIE

PENSILINE

COLORI

SEZ. TECNICA

Jolly/KG1 Pegaso/KM

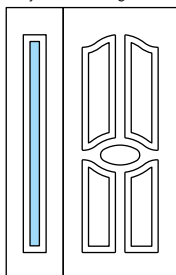

Jolly/KG Urania/K

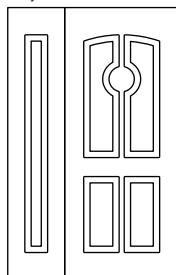



**IKARO/K**

Colore: RAL 7005 Grinz

Maniglia: A 309

Battente: A 320



Jolly/KG

Ikaro/K

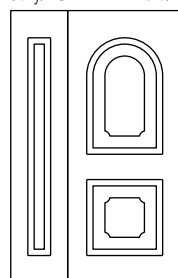

**IKARO/K1**

Colore: RAL 7038 Grinz  
Vetro: decoro GS (3)  
Grata in acciaio inox GI\*  
Maniglia: A 618



**IKARO/KB1**

Colore: RAL 7035 Grinz  
Vetro: decoro RC (14)  
Maniglia: A 961



INFINITY

STYLE

A FILO

EMOTION

**NOVECENTO**

INCYSO

VETRI E DECORI

MANIGLIE

PENSILINE

COLORI

SEZ. TECNICA

\* Soluzione su richiesta

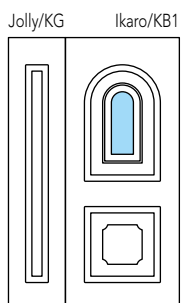
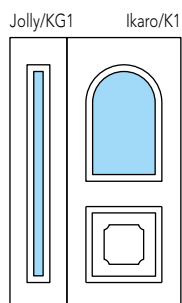



**porta PALLADIO/K**  
Colore: RAL 8017 Grinz  
Maniglia: A 470

**pensilina OLDSTYLE Mod. OS-02**  
Colore struttura: RAL 8017 Grinz  
Copertura: Bronzo  
**vela Mod. VL-01**  
Colore struttura: RAL 8017 Grinz  
Pannello: Bronzo



**PALLADIO/K**

Colore: Salvia AK11V Grinz Mix  
Maniglia: A 570  
Battente: A 525



**PALLADIO/K1**

Colore: RAL 6005 Grinz  
Vetro: decoro AC (35)  
Maniglia: A 470



**PALLADIO/K1**

Colore: Verde P7103 Grinz Mix  
Vetro: decoro GS (35)  
Grata in acciaio Inox GI\*  
Maniglia: A 618



\* Soluzione su richiesta

Jolly/KG Palladio/K

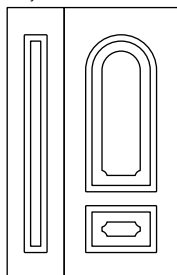

Jolly/KBG Palladio/K1

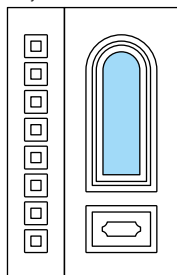

**NOVECENTO**  
COLLECTION



**ANTARES/KS**  
Colore: Bleu AK15V Grinz

**ANTARES/KD1**  
Colore: Bleu AK15V Grinz  
Vetro: decoro GP (7)  
Maniglia: A 314

**ANTARES/KD**

Colore: RAL 5003 Grinz  
Maniglia: A 514  
Battente: A 540



**ANTARES/KD1**

Colore: RAL 5014 Grinz  
Vetro: decoro GS (7)  
Grata in acciaio Inox GI\*  
Maniglia: A 514



INFINITY

STYLE

A FILO

EMOTION

**NOVECENTO**

INCYSO

VETRI E DECORI

MANIGLIE

PENSILINE

COLORI

SEZ. TECNICA

\* Soluzione su richiesta

Antares/KS Antares/KD1

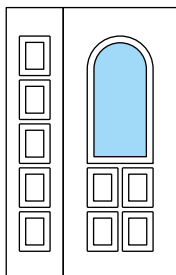

Jolly/K1 Antares/KD

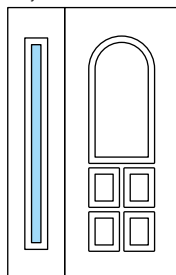

# NOVECENTO

COLLECTION

## SIRIO/K1

Colore: RAL 7044 Grinz  
Vetro: decoro FN (3)  
Maniglia: A 307



## SIRIO/K

Colore: Ciliegio RP03L  
Maniglia: A 507  
Battente: A 525



Alfair/KS1 Sirio/K1

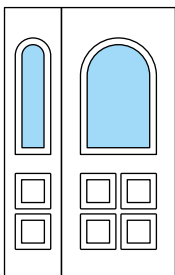

Alfair/KS Sirio/K

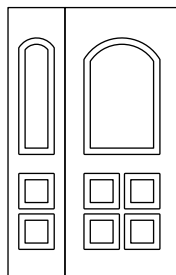

Grata Inox GI\*

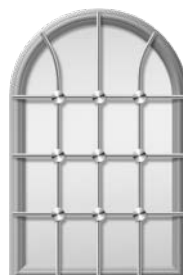

**SIRIO/KC**

Colore: Corten V001V Grinz Mix  
Maniglia: A 515  
Battente: A 522



**SIRIO/KE**

Colore: Bronzo TR03V Grinz  
Maniglia: A 415  
Battente: A 422

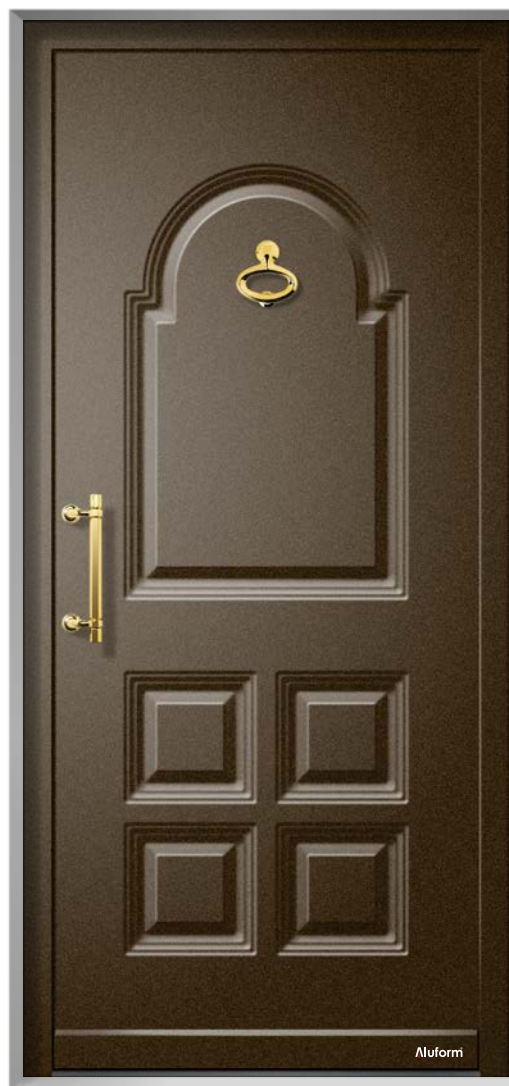

INFINITY

STYLE

A FILO

EMOTION

**NOVECENTO**

INCYSO

VETRI E DECORI

MANIGLIE

PENSILINE

COLORI

SEZ. TECNICA

\* Soluzione su richiesta

Alfair/KS Sirio/KC

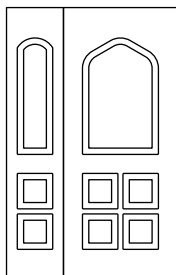

Jolly/K1 Sirio/KE

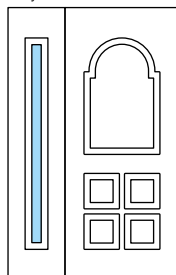

Jolly/KB Sirio/KE

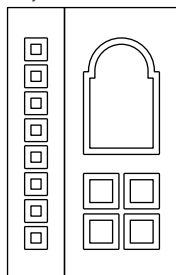

**NOVECENTO**  
COLLECTION



**ALFAIR/KS1**

Colore: Ciliegio RP02L  
Vetro: decoro AC (8)

**REGOLO/KA1**

Colore: Ciliegio RP02L  
Vetro: decoro AC (3)  
Maniglia: A 406

**REGOLO/KA**

Colore: RAL 7006 Grinz  
Maniglia: A 506  
Battente: A 520



**REGOLO/KC**

Colore: RAL 7032 Grinz  
Maniglia: A 406  
Battente: A 425



INFINITY

STYLE

A FILO

EMOTION

**NOVECENTO**

INCYSO

VETRI E DECORI

MANIGLIE

PENSILINE

COLORI

SEZ. TECNICA

\* Soluzione su richiesta

Alfair/KS1 Regolo/KA1

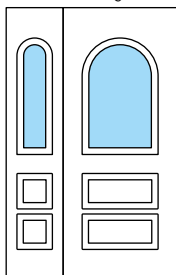

Alfair/KS Regolo/KA

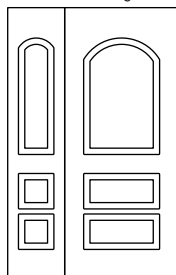

Jolly/K1 Regolo/KC

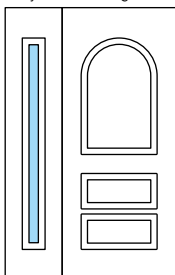

Grata Inox GI\*





**REGOLO/KB**

Colore: Ciliegio PVC RP04L  
Maniglia: A 309  
Battente: A 320



**REGOLO/KBM**

Colore: RAL 7044 Grinz  
Maniglia: A 409



Regolo/KBS Regolo/KB

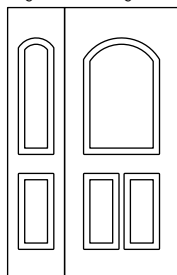

Regolo/KBM

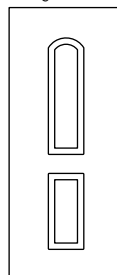



**REGOLO/KD**

Colore: RAL 1019 Grinz  
Maniglia: A 509  
Battente: A 540



**REGOLO/KD1**

Colore: RAL 8011 Grinz  
Vetro: decoro RC (3)  
Maniglia: A 517



**REGOLO/KDM1**

Colore: Noce PVC RP06L  
Vetro: decoro GP (8)  
Maniglia: A 417



INFINITY

STYLE

A FILO

EMOTION

**NOVECENTO**

INCYSO

VETRI E DECORI

MANIGLIE

PENSILINE

COLORI

SEZ. TECNICA

\* Soluzione su richiesta

Regolo/KBS Regolo/KD

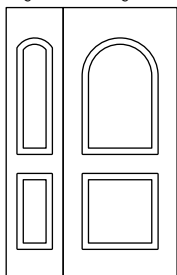

Regolo/KDS1 Regolo/KD1

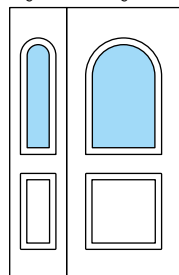

Regolo/KDM1

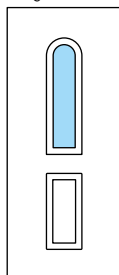

Grata Inox GI\*





Aluform

**RIGEL/KB**

Colore: Noce RP08L

Maniglia: A 470

Battente: A 425

**RIGEL/K**

Colore: Corten V001V Grinz Mix  
Maniglia: A 570



**RIGEL/K2**

Colore: RAL 8011 Grinz  
Vetro: decoro FN (2)  
Maniglia: A 470



**RIGEL/KM1**

Colore: Ciliegio RP03L  
Vetro: decoro AC (2)  
Maniglia: A 613



Rigel/KS Rigel/KB

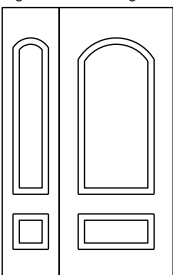

Rigel/KM

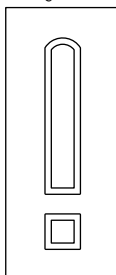

Rigel/KS Rigel/K

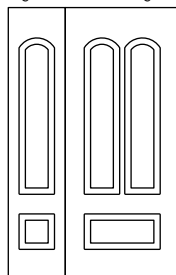

Rigel/KS1 Rigel/K2

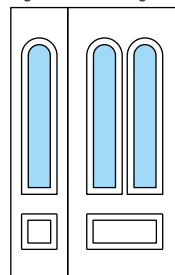

Rigel/KM1

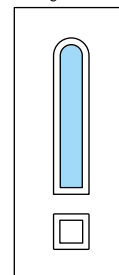

**NOVECENTO**  
COLLECTION



**ALFAIR/KS**  
Colore: RAL 7016 Grinz

**ALFAIR/K**  
Colore: RAL 7016 Grinz  
Maniglia: A 416

**ALFAIR/K2**

Colore: RAL 7005 Grinz  
Vetro: decoro GS (8)  
Maniglia: A 516



**ALFAIR/KM**

Colore: Grigio P7000 Mix  
Maniglia: A 507



**ALFAIR/KM1**

Colore: RAL 7004 Grinz  
Vetro: decoro GC (8)  
Maniglia: A 407



INFINITY

STYLE

A FILO

EMOTION

**NOVECENTO**

INCYSO

VETRI E DECORI

MANIGLIE

PENSILINE

COLORI

SEZ. TECNICA

Alfair/KS      Alfair/K

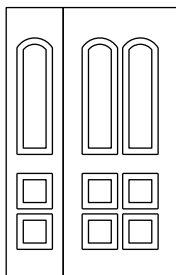

Alfair/KS1      Alfair/K2

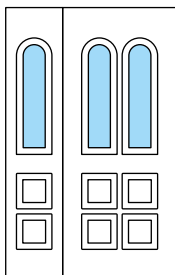

Alfair/KM

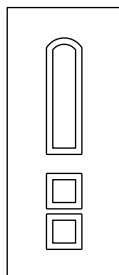

Alfair/KM1

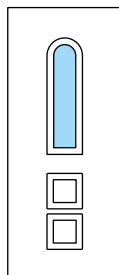

# NOVECENTO

COLLECTION

## ALDEBARAN/K

Colore: Marrone P7203 Grinz Mix

Maniglia: A 702

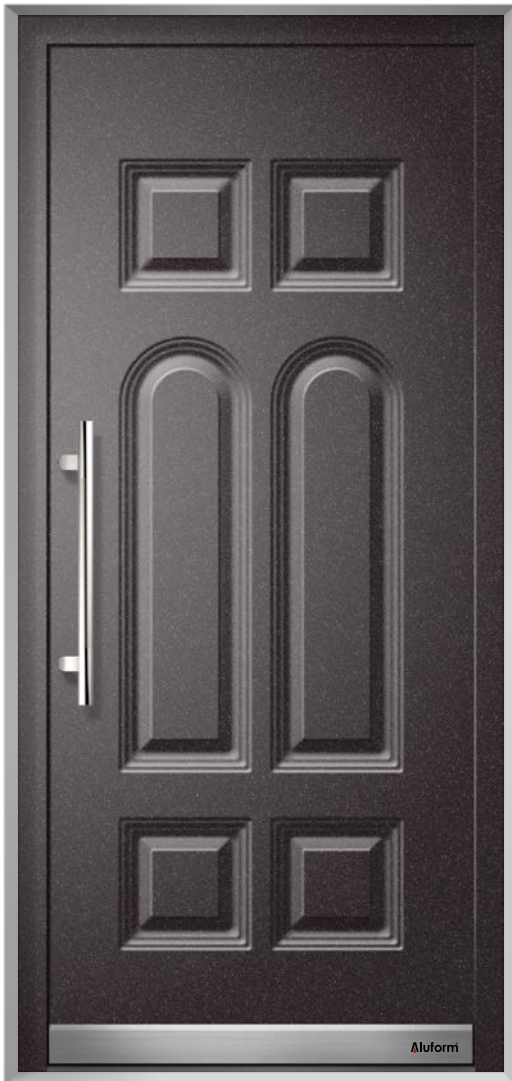

## ALDEBARAN/K2

Colore: RAL 6005 Grinz

Vetro: decoro RC (8)

Maniglia: A 702



Aldeb./KS Aldebaran/K

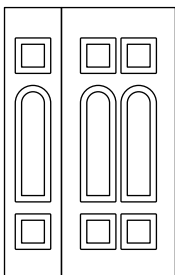

Jolly/K Aldebaran/K

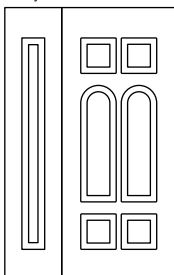

Aldeb./KS1 Aldebaran/K2

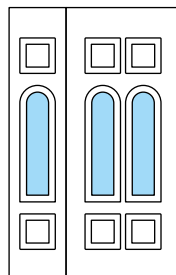

**ALDEBARAN/KM**

Colore: Grigio P7003 Grinz Mix  
Maniglia: A 700

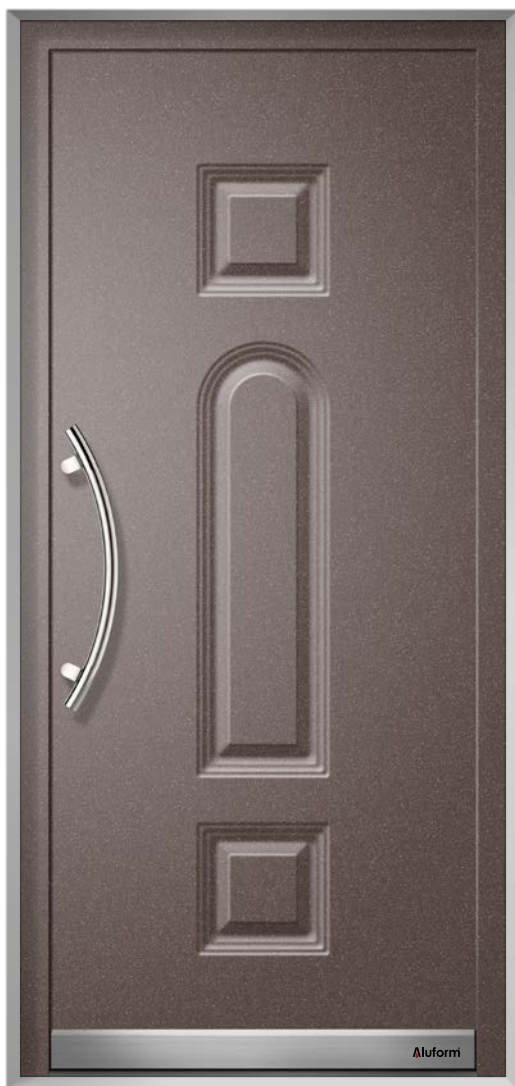

**ALDEBARAN/KM1**

Colore: Verde P7103 Grinz Mix  
Vetro: decoro GC (8)  
Maniglia: A 700

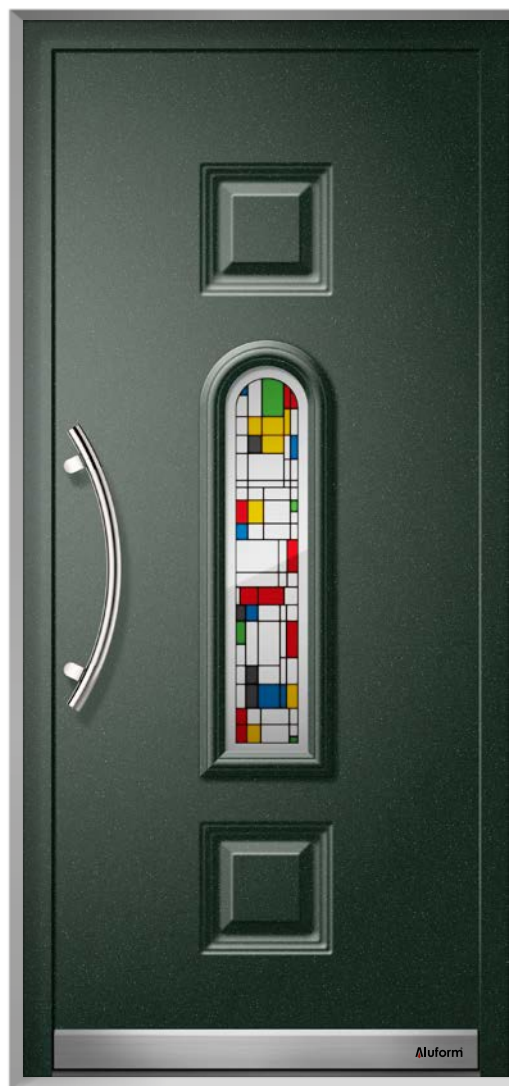

INFINITY

STYLE

A FILO

EMOTION

**NOVECENTO**

INCYSO

VETRI E DECORI

MANIGLIE

PENSILINE

COLORI

SEZ. TECNICA

Aldebaran/KM

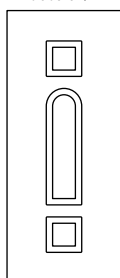

Aldebaran/KM1

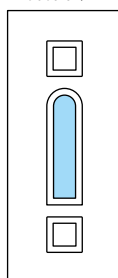



Aluformi

**GEMINI/K1**  
Colore: Salvia AK11V Grinz Mix  
Vetro: decoro GS (2)  
Maniglia: A 517



**GEMINI/K**

Colore: RAL 7038 Grinz  
Maniglia: A 517  
Battente: A 540



**GEMINI/K1**

Colore: RAL 7035 Grinz  
Vetro: decoro RC (2)  
Maniglia: A 417



INFINITY

STYLE

A FILO

EMOTION

**NOVECENTO**

INCYSO

VETRI E DECORI

MANIGLIE

PENSILINE

COLORI

SEZ. TECNICA

Jolly/KG Gemini/K

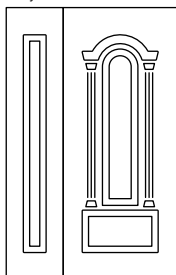

Jolly/KG1 Gemini/K1

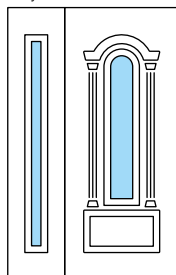

## NOVECENTO

COLLECTION

### GEO/K

Colore: Verde P7103 Grinz Mix

Maniglia: A 409

Battente: A 420

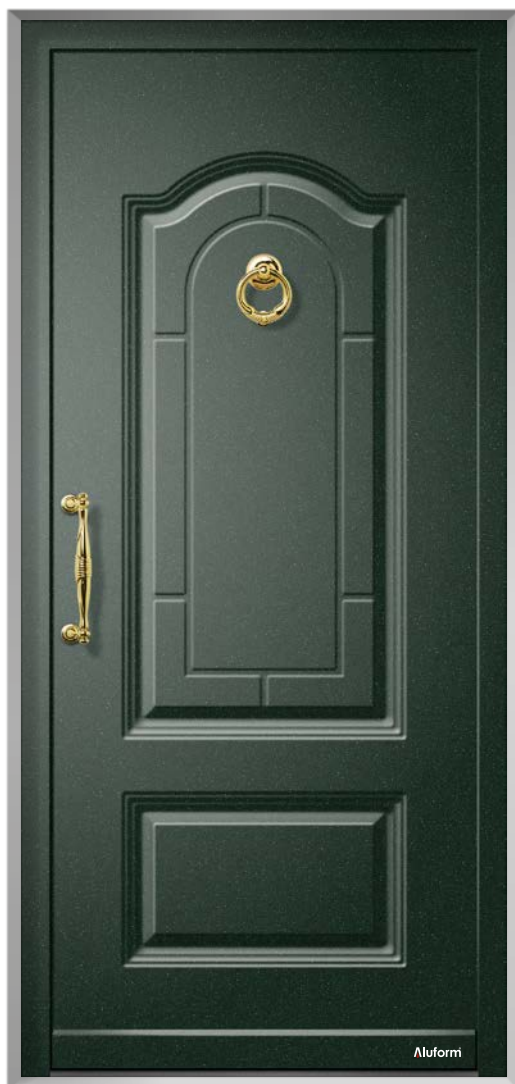

### GEO/K1

Colore: Salvia AK11V Grinz Mix

Vetro: decoro GP (8)

Maniglia: A 509



Jolly/KG Geo/K

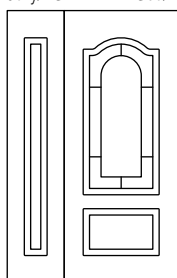

Jolly/KG1 Geo/K1

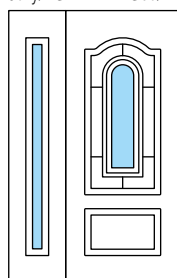

**PERSEO/K**

Colore: Corten V001V Grinz Mix  
Maniglia: A 416  
Battente: A 440



**PERSEO/K1**

Colore: Ciliegio PVC RP04L  
Vetro: decoro FN (8)  
Maniglia: A 516



INFINITY

STYLE

A FILO

EMOTION

**NOVECENTO**

INCYSO

VETRI E DECORI

MANIGLIE

PENSILINE

COLORI

SEZ. TECNICA

Jolly/KG Perseo/K

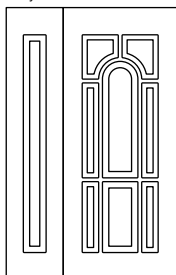

Jolly/KG1 Perseo/K1

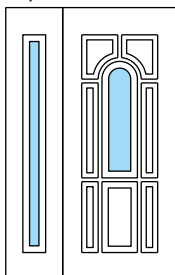

**NOVECENTO**  
COLLECTION



**JOLLY/KG1**

Colore: RAL 7044 Grinz  
Vetro: decoro GP (31)

**GEMMA/K1**

Colore: RAL 7044 Grinz  
Vetro: decoro GP (11)  
Maniglia: A 318

**GEMMA/K**

Colore: RAL 7006 Grinz  
Maniglia: A 418



**GEMMA/K1**

Colore: RAL 8017 Grinz  
Vetro: decoro AC (11)  
Maniglia: A 518



INFINITY

STYLE

A FILO

EMOTION

**NOVECENTO**

INCYSO

VETRI E DECORI

MANIGLIE

PENSILINE

COLORI

SEZ. TECNICA

Jolly/KBG Gemma/K

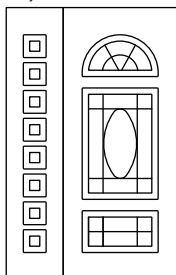

Jolly/KG1 Gemma/K1

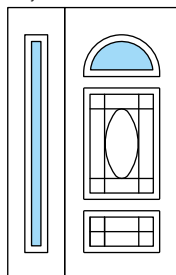

## NOVECENTO

COLLECTION

### QUASAR/K

Colore: Bronzo TR03V Grinz

Maniglia: A 406

Battente: A 425

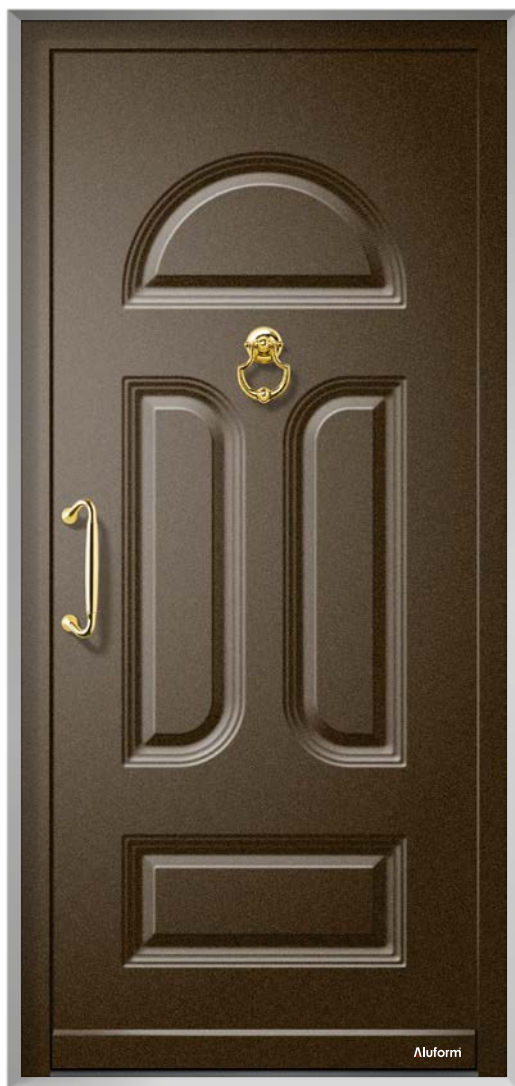

### QUASAR/K1

Colore: Grigio P7003 Grinz Mix

Vetro: decoro RC (11)

Maniglia: A 506

Battente: A 520

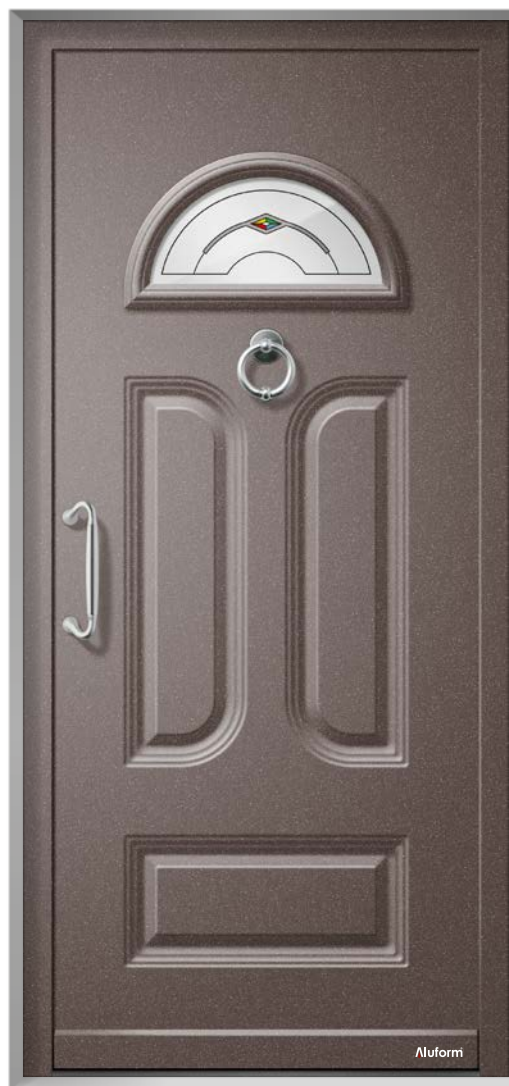

Jolly/KG Quasar/K

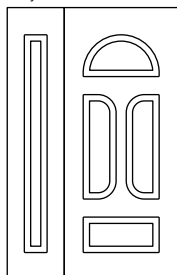

Jolly/KG1 Quasar/K1

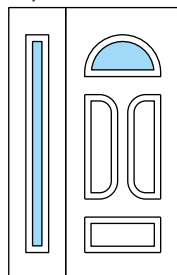

**QUASAR/KB**

Colore: RAL 7030 Grinz  
Maniglia: A 515



**QUASAR/KB3**

Colore: RAL 7038 Grinz  
Vetro: decoro FN (11-37)  
Maniglia: A 415



INFINITY

STYLE

A FILO

EMOTION

**NOVECENTO**

INCYSO

VETRI E DECORI

MANIGLIE

PENSILINE

COLORI

SEZ. TECNICA

Jolly/KBG Quasar/KB

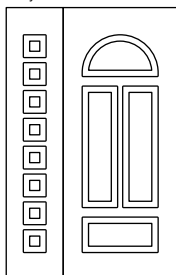

Jolly/KG1 Quasar/KB3

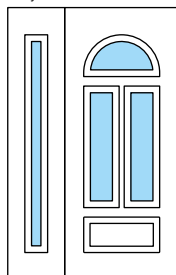

**NOVECENTO**  
COLLECTION



**MINERVA/KS1**

Colore: RAL 5003 Grinz  
Vetro: decoro GC (15)

**MINERVA K1**

Colore: RAL 5003 Grinz  
Vetro: decoro GC (11)  
Maniglia: A 507



**MINERVA/K**

Colore: RAL 7016 Grinz  
Maniglia: A 507



**MINERVA/K1**

Colore: Grigio P7000 Mix  
Vetro: decoro GS (11)  
Maniglia: A 700



**MINERVA/KM**

Colore: RAL 9007 Grinz  
Maniglia: A 307



Minerva/KS Minerva/K

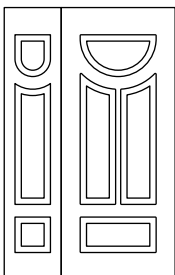

Minerva/KS1 Minerva/K1

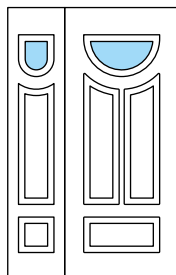

Minerva/KM

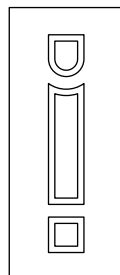

Minerva/KM1

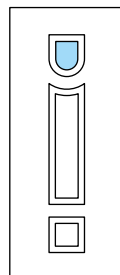



**LIBRA/K**  
Colore: RAL 6005 Grinz  
Pomo: A 430

**LIBRA/K1**

Colore: RAL 7032 Grinz  
Vetro: decoro GP (11)  
Pomo: A 330



**LIBRA/KB**

Colore: RAL 3004 Grinz  
Pomo: A 530



INFINITY

STYLE

A FILO

EMOTION

**NOVECENTO**

INCYSO

VETRI E DECORI

MANIGLIE

PENSILINE

COLORI

SEZ. TECNICA

Jolly/KG      Libra/K

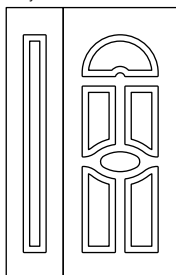

Jolly/KG1      Libra/K1

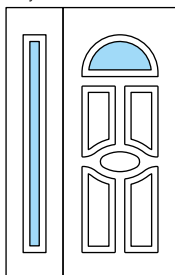

Jolly/KG1      Libra/KB

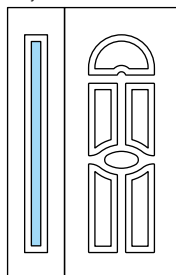

**NOVECENTO**  
COLLECTION

**BELLATRIX/K**

Colore: Noce PVC RP06L  
Maniglia: A 418



**BELLATRIX/KM**

Colore: RAL 8017 Grinz  
Maniglia: A 318



**BELLATRIX/K1**

Colore: Bronzo TR03V Grinz  
Vetro: decoro FN (11)  
Maniglia: A 518

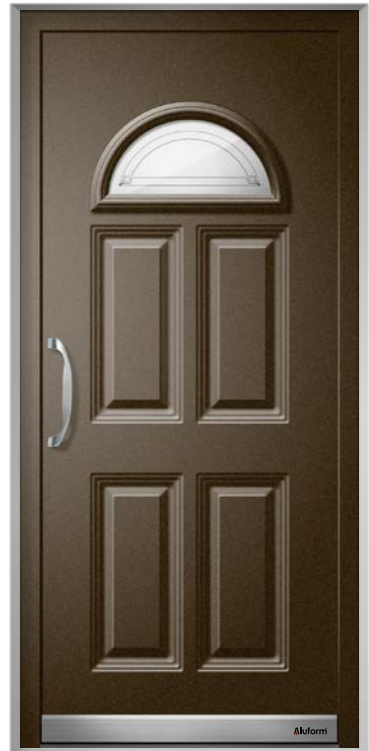

Bellatrix/KS Bellatrix/K

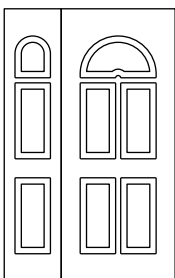

Bellatrix/KM

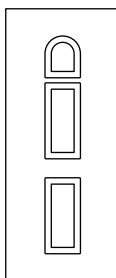

Bellatrix/KS1 Bellatrix/K1

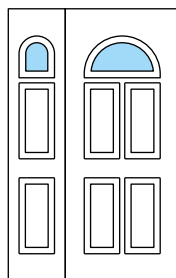

Bellatrix/KM1

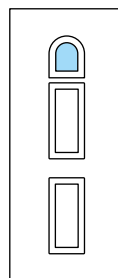

**BELLATRIX/K3**

Colore: RAL 7030 Grinz  
Vetro: decoro RC (11-27)  
Maniglia: A 409



**BELLATRIX/K5**

Colore: RAL 7044 Grinz  
Vetro: Satinato A (11-27)  
Maniglia: A 509



**BELLATRIX/KM3**

Colore: RAL 9010 Grinz  
Vetro: decoro FN (15-27)  
Maniglia: A 309



Bellatrix/KS2 Bellatrix/K3

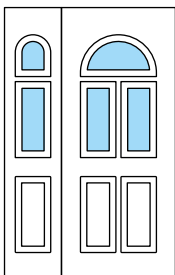

Bellatrix/KM2

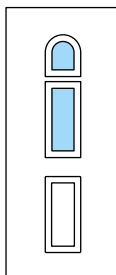

Bellatrix/KS3 Bellatrix/K5

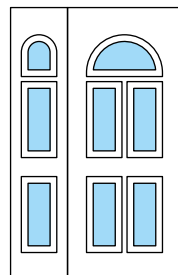

Bellatrix/KM3

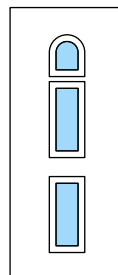

# NOVECENTO

COLLECTION

## MIRANDA/K

Colore: RAL 7035 Grinz  
Maniglia: A 416



## MIRANDA/K1

Colore: RAL 7038 Grinz  
Vetro: decoro AC (22)  
Maniglia: A 616



Jolly/KG    Miranda/K

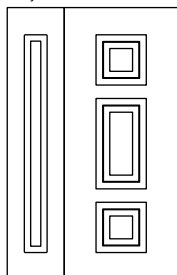

Jolly/KG    Miranda/K1

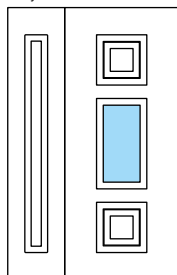

Jolly/KG1    Miranda/K2

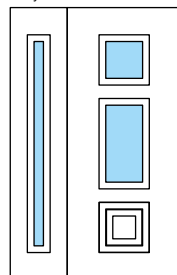

**MIRANDA/KB**

Colore: Verde P7100 Mix  
Maniglia: A 407

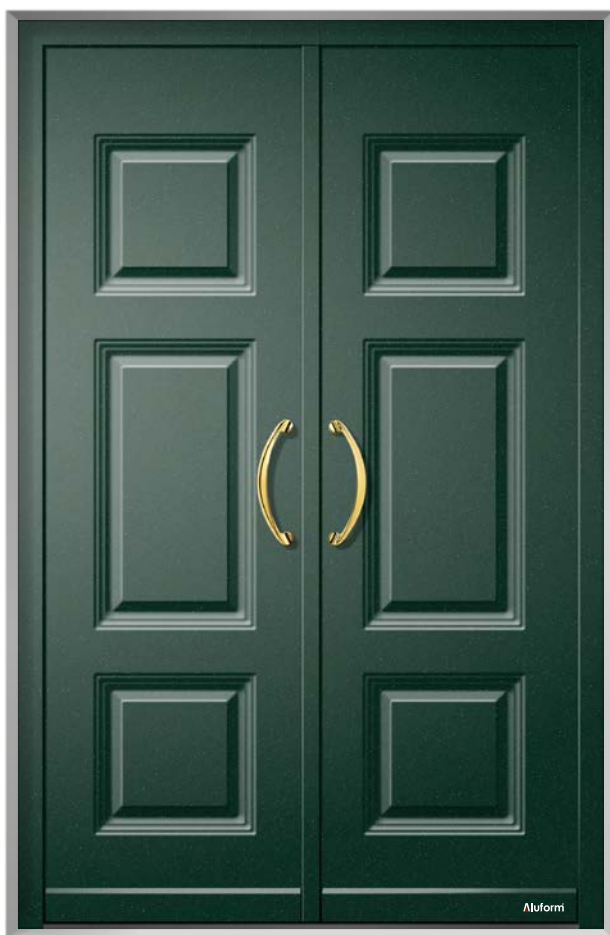

**MIRANDA/K3**

Colore: RAL 6009 Grinz  
Cornice vetro: RAL 7038 Grinz\*  
Vetro: decoro GS (25-22)  
Maniglia: A 407



\* Soluzione su richiesta

Jolly/KG    Miranda/KB

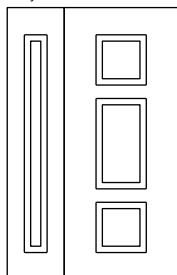

Jolly/KG1    Miranda/KB1

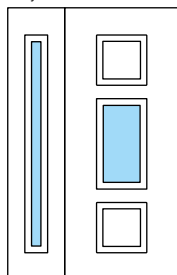

Jolly/KG1    Miranda/K3

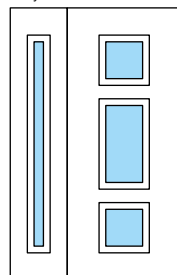

Grata Inox GI\*



Grata Inox GI\*





numero civico NC...  
placca + 2 cifre

**porta TRIADE/K**  
Colore: Grigio P7003 Grinz Mix  
Maniglia: A 515  
Battente: A 522



**TRIADE/K**

Colore: RAL 9007 Grinz  
Maniglia: A 622



**TRIADE/K1**

Colore: RAL 8019 Grinz  
Vetro: decoro FN (25)  
Maniglia: A 622



INFINITY

STYLE

A FILO

EMOTION

**NOVECENTO**

INCYSO

VETRI E DECORI

MANIGLIE

PENSILINE

COLORI

SEZ. TECNICA

\* Soluzione su richiesta

Triade/KBS      Triade/K

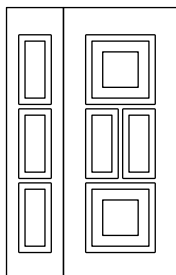

Jolly/KG1      Triade/K1

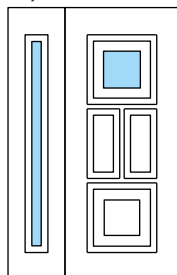

Grata Inox GI\*



**NOVECENTO**  
COLLECTION



**TRIADE/KBS**  
Colore: Rosso P7300 Mix

**TRIADE/KC**  
Colore: Rosso P7300 Mix  
Maniglia: A 318

**TRIADE/KC**

Colore: RAL 7011 Grinz  
Maniglia: A 518  
Battente: A 522



**TRIADE/KC1**

Colore: RAL 3005 Grinz  
Vetro: decoro GP (25)  
Maniglia: A 961 X (RAL 3005 Grinz)



INFINITY

STYLE

A FILO

EMOTION

**NOVECENTO**

INCYSO

VETRI E DECORI

MANIGLIE

PENSILINE

COLORI

SEZ. TECNICA

\* Soluzione su richiesta

Triade/KBS Triade/KC

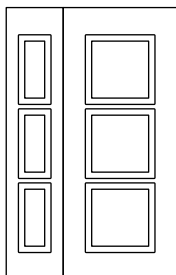

Jolly/KG1 Triade/KC1

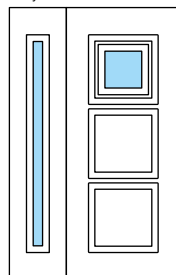

Grata Inox GI\*



# NOVECENTO

COLLECTION

## TRIADE/KBS

Colore: Verde  
P7103 Grinz Mix

## TRIADE/KB

Colore: Verde P7103 Grinz Mix  
Maniglia: A 516

## TRIADE/KBM

Colore: RAL 6009 Grinz  
Maniglia: A 700



Triade/KBS Triade/KB

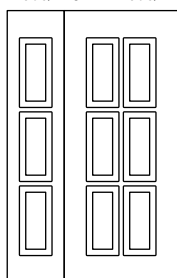

Triade/KBM

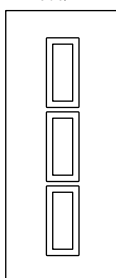

**ANTARES/KS**

Colore: Salvia  
AK11V Grinz Mix

**ANTARES/K**

Colore: Salvia AK11V Grinz Mix  
Maniglia: A 416

**ANTARES/KM**

Colore: RAL 7032 Grinz  
Maniglia: A 700



INFINITY

STYLE

A FILO

EMOTION

**NOVECENTO**

INCYSO

VETRI E DECORI

MANIGLIE

PENSILINE

COLORI

SEZ. TECNICA

Antares/KS    Antares/K

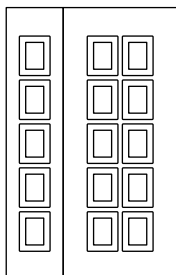

Antares/KM

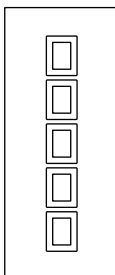

**NOVECENTO**  
COLLECTION



**TRIADE/KBS**

Colore: Orange AK38V Grinz

**IRIS/K**

Colore: Orange AK38V Grinz  
Maniglia: A 682

**IRIS/K1**

Colore: RAL 3003 Grinz  
Vetro: decoro RC (25)  
Maniglia: A 686



**IRIS/KC1**

Colore: RAL 3005 Grinz  
Vetro: decoro GS (25)  
Grata in acciaio Inox GI\*  
Maniglia: A 703



**IRIS/K3**

Colore: Rosso P7300 Mix  
Vetro: decoro FN (25)  
Maniglia: A 624



\* Soluzione su richiesta

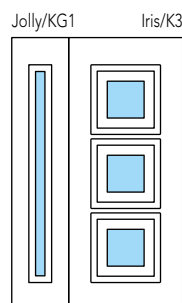
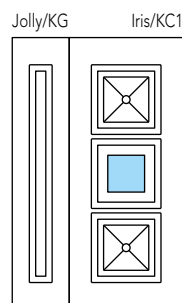
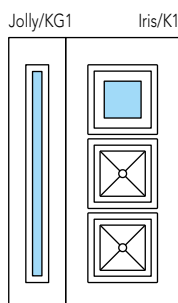
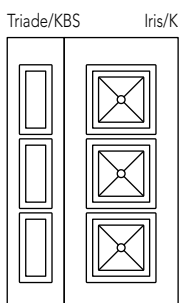

**NOVECENTO**  
COLLECTION

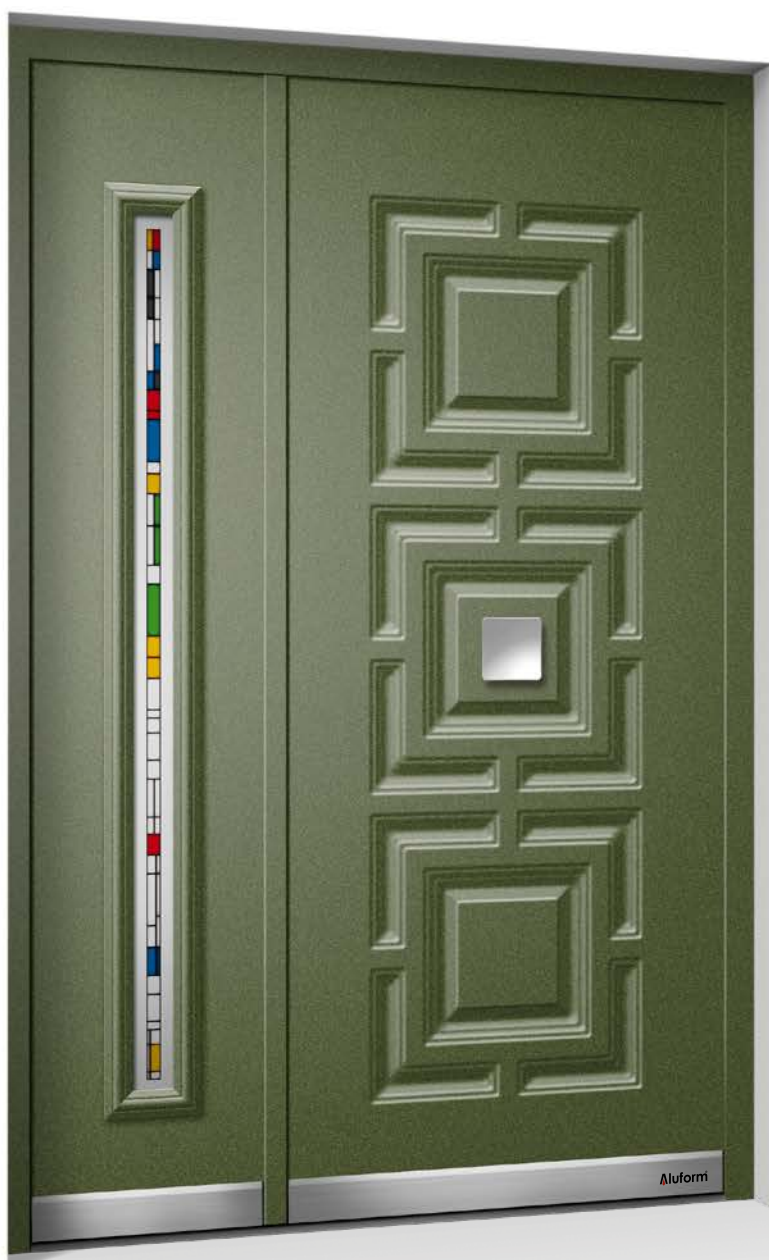

**JOLLY/KG1**

Colore: Salvia AK11V Grinz Mix  
Vetro: decoro GC (31)

**GRADARA/K**

Colore: Salvia AK11V Grinz Mix  
Maniglia: A 945



**GRADARA/KB**

Colore: Bleu AK15V Grinz  
Maniglia: A 516  
Battente: A 520



**GRADARA/KB1**

Colore: RAL 5014 Grinz  
Vetro: decoro FN (36)  
Maniglia: A 516



INFINITY

STYLE

A FILO

EMOTION

**NOVECENTO**

INCYSO

VETRI E DECORI

MANIGLIE

PENSILINE

COLORI

SEZ. TECNICA

\* Soluzione su richiesta

Jolly/KG1 Gradara/K

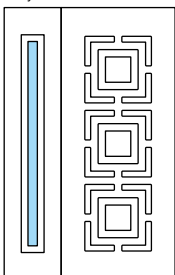

Triade/KBS Gradara/K

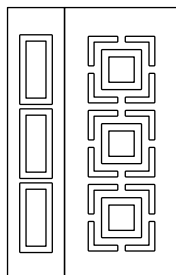

Jolly/KG Gradara/KB

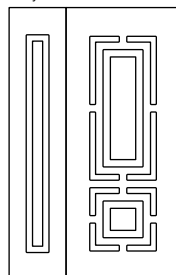

Jolly/KG Gradara/KB1

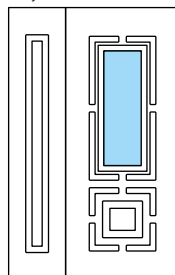

Grata Inox GI\*





Aluform

**QUATER/KS**  
Colore: Bleu AK15V Grinz

**QUATER/K**  
Colore: Bleu AK15V Grinz  
Maniglia: A 570

**JOLLY/KG1**

Colore:  
RAL 7030 Grinz  
Vetro: Satinato A (31)

**QUATER/K4**

Colore: RAL 7030 Grinz  
Vetro: Satinato A (40)  
Maniglia: A 613

**QUATER/K**

Colore: Ciliegio PVC RP04L  
Maniglia: A 418  
Battente: A 440



INFINITY

STYLE

A FILO

EMOTION

**NOVECENTO**

INCYSO

VETRI E DECORI

MANIGLIE

PENSILINE

COLORI

SEZ. TECNICA

Quater/KS    Quater/K

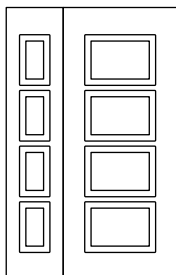

Jolly/KG1    Quater/K4

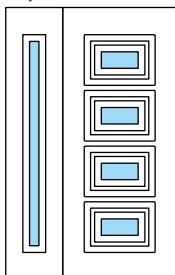

Luce/KHS4    Quater/K4

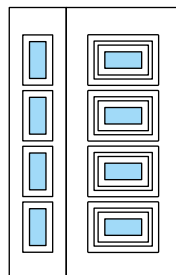

Quater/KM

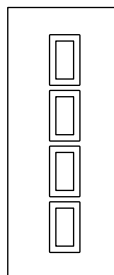

**NOVECENTO**  
COLLECTION



**JOLLY/KG**  
Colore: Noce RP07L

**BASILEO/K**  
Colore: Noce RP07L  
Maniglia: A 407  
Battente: A 425

**BASILEO/K**

Colore: Corten V001V Grinz Mix  
Maniglia: A 507



**BASILEO/K1**

Colore: Rame bugnato AK02V  
Vetro: decoro GC (16)  
Maniglia: A 507



INFINITY

STYLE

A FILO

EMOTION

**NOVECENTO**

INCYSO

VETRI E DECORI

MANIGLIE

PENSILINE

COLORI

SEZ. TECNICA

Jolly/KG Basileo/K

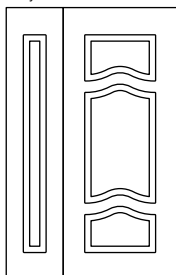

Jolly/KG1 Basileo/K1

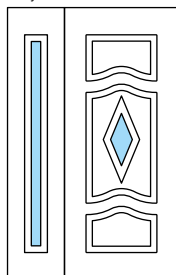

# NOVECENTO

COLLECTION

## ALGENIB/KB

Colore: Avorio AK16V Grinz  
Maniglia: A 961



## ALGENIB/KC

Colore: RAL 3004 Grinz  
Maniglia: A 700



Algenib/KS Algenib/KB

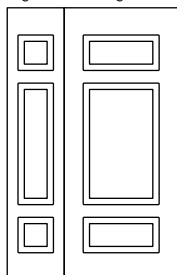

Algenib/KS Algenib/KC

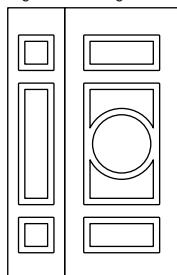

**ALGENIB/KE**

Colore: Marrone P7200 Mix  
Maniglia: A 702



**ALGENIB/KE1**

Colore: Black Cherry 3202 001-167  
Vetro: decoro RC (16)  
Maniglia: A 418



INFINITY

STYLE

A FILO

EMOTION

**NOVECENTO**

INCYSO

VETRI E DECORI

MANIGLIE

PENSILINE

COLORI

SEZ. TECNICA

Algenib/KS Algenib/KE

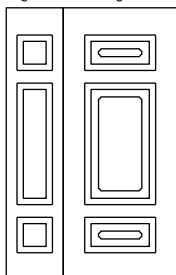

Jolly/KG1 Algenib/KE1

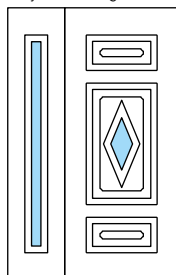

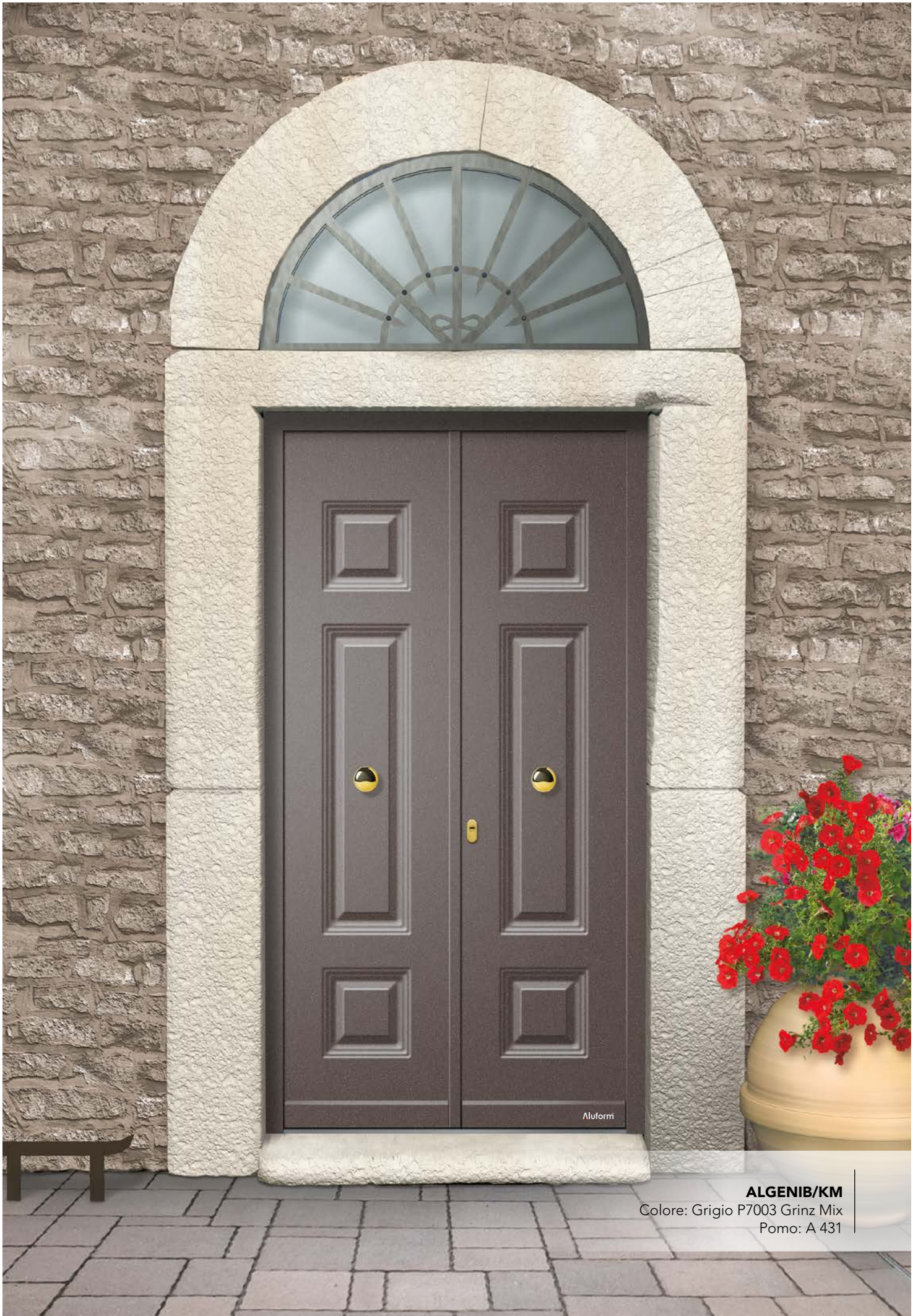

Aluform

**ALGENIB/KM**

Colore: Grigio P7003 Grinz Mix  
Pomo: A 431



**ALGENIB/K**

Colore: RAL 7011 Grinz  
Maniglia: A 316



**ALGENIB/K2**

Colore: RAL 7015 Grinz  
Vetro: decoro GS (37)  
Maniglia: A 516



**ALGENIB/KM3**

Colore: Antracite P016V Grinz  
Cornice vetro: RAL 7035 Grinz\*  
Vetro: decoro FN (26-37)  
Maniglia: A 616



Algenib/KS Algenib/K

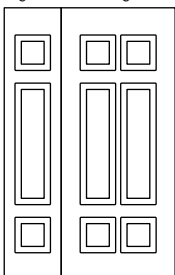

Algenib/KM

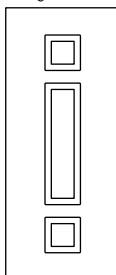

Algenib/KS1 Algenib/K2

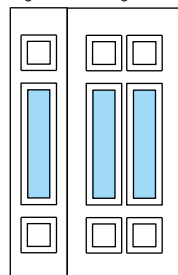

Algenib/KM1

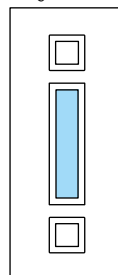

Algenib/KS3 Algenib/K6

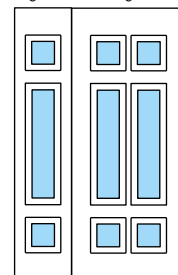

Algenib/KM3

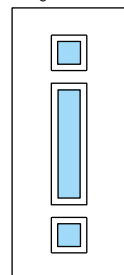

\* Soluzione su richiesta



**ALGENIB/KD**

Colore: RAL 7011 Grinz  
Maniglia: A 618



**ALIZAR/K**

Colore: Marrone P7203 Grinz Mix  
Maniglia: A 701



Algenib/KS Algenib/KD

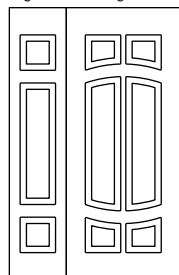

Alizar/KS Alizar/K

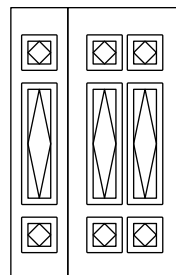

**ALIZAR/KM**

Colore: RAL 9005 Grinz  
Maniglia: A 703



**MIZAR/K**

Colore: RAL 7016 Grinz  
Maniglia: A 702



**MIZAR/KM**

Colore: RAL 7044 Grinz  
Maniglia: A 682



Alizar/KM

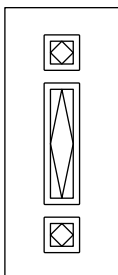

Mizar/KS



Mizar/K

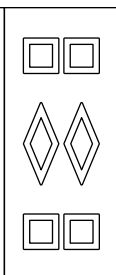

Mizar/KM

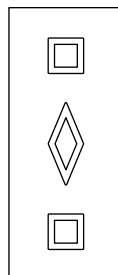

# NOVECENTO

COLLECTION

## ERIDANO/K

Colore: Noce RP05L  
Maniglia: A 316



## ERIDANO/KM

Colore: Marrone P7200 Mix  
Maniglia: A 416



## ERIDANO/K2

Colore: RAL 8017 Grinz  
Vetro: decoro GP (27)  
Maniglia: A 516



Eridano/KS Eridano/K

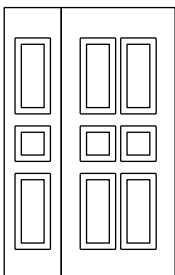

Jolly/K Eridano/K

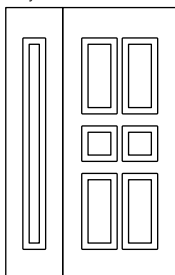

Eridano/KM

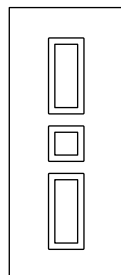

Eridano/KS1 Eridano/K2

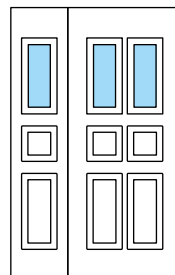

**ERIDANO/KM1**

Colore: Ciliegio RP03L  
Vetro: decoro AC (27)  
Maniglia: A 309



**ERIDANO/K6**

Colore: RAL 8011 Grinz  
Vetro: decoro GS (27-26)  
Maniglia: A 409



**ERIDANO/KM3**

Colore: Corten AK10V Grinz Mix  
Vetro: decoro FN (27-26)  
Maniglia: A 509



Eridano/KM1

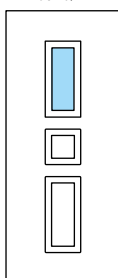

Eridano/KS3 Eridano/K6

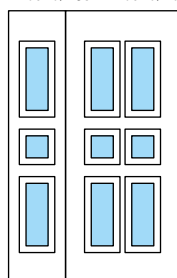

Eridano/KM3

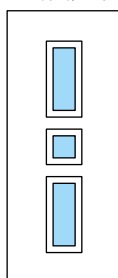

**NOVECENTO**  
COLLECTION

**MIRA/K**

Colore: Grigio P7003 Grinz Mix  
Maniglia: A 370



**MIRA/KM**

Colore: Grigio P7000 Mix  
Maniglia: A 470



**MIRA/K2**

Colore: Antracite P016V Grinz  
Vetro: decoro GS (26)  
Maniglia: A 570



Mira/KS Mira/K

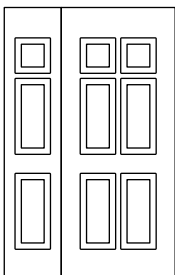

Mira/KM

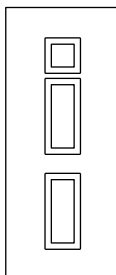

Mira/KS1 Mira/K2

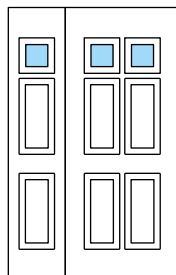

Mira/KM1

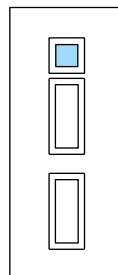

**MIRA/K4**

Colore: RAL 6005 Grinz  
Vetro: decoro GP (26-27)  
Maniglia: A 506



**MIRA/K6**

Colore: RAL 6009 Grinz  
Vetro: decoro FN (26-27)  
Maniglia: A 506



**MIRA/KM3**

Colore: RAL 7035 Grinz  
Cornice vetro: Verde P7100 Mix\*  
Vetro: decoro RC (26-27)  
Maniglia: A 406



\* Soluzione su richiesta

Mira/KS2      Mira/K4

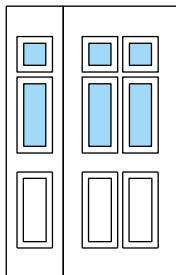

Mira/KM2

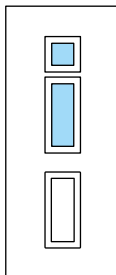

Mira/KS3      Mira/K6

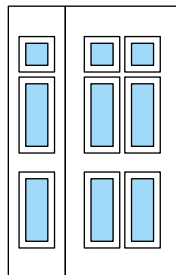

Mira/KM3

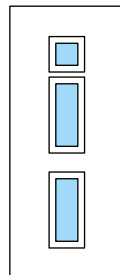



Aluform

**TITANO/K**

Colore: Corten V001V Grinz Mix  
Maniglia: A 515



**TITANO/K2**

Colore: RAL 8014 Grinz  
Vetro: decoro GP (26)  
Maniglia: A 415



**TITANO/KM1**

Colore: RAL 3005 Grinz  
Vetro: decoro GS (26)  
Maniglia: A 515



Titano/KS Titano/K

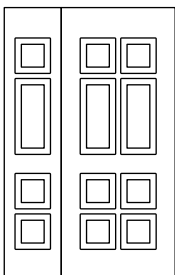

Titano/KM

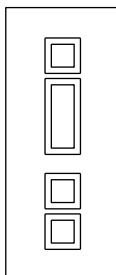

Titano/KS1 Titano/K2

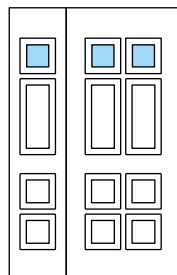

Titano/KM1

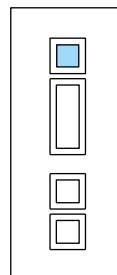

**NOVECENTO**  
COLLECTION



**ALFA/KS**  
Colore: Noce RP05L

**ALFA/K**  
Colore: Noce RP05L  
Maniglia: A 318

**ALFA/KM**

Colore: Avorio AK16V Grinz  
Maniglia: A 409



**ALFA/KBM5**

Colore: Rosso P7300 Mix  
Cornice vetro: Avorio AK16V Grinz\*  
Vetro: decoro GS (26)  
Maniglia: A 407



**ALFA/KBM3**

Colore: RAL 3004 Grinz  
Vetro: decoro GC (26)  
Maniglia: A 971 X (RAL 3004 Grinz)



\* Soluzione su richiesta

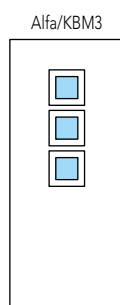
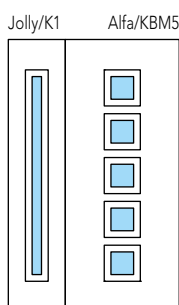
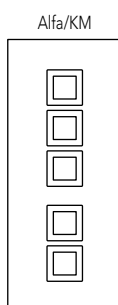
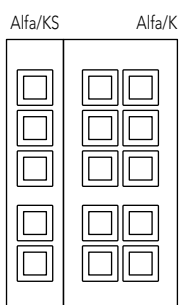

# NOVECENTO

COLLECTION

## CASTORE/K

Colore: Antracite P016V Grinz  
Maniglia: A 418



## CASTORE/K1

Colore: RAL 7004 Grinz  
Vetro: decoro GC (25b)  
Maniglia: A 518



Jolly/KG Castore/K

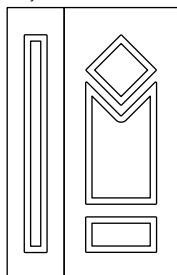

Jolly/KG1 Castore/K1

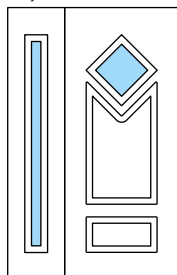

**DORADO/K**

Colore: Bleu AK15V Grinz  
Maniglia: A 682



**DORADO/K1**

Colore: RAL 5014 Grinz  
Vetro: decoro GS (25b)  
Grata in acciaio Inox GI\*  
Maniglia: A 686



INFINITY

STYLE

A FILO

EMOTION

**NOVECENTO**

INCYSO

VETRI E DECORI

MANIGLIE

PENSILINE

COLORI

SEZ. TECNICA

\* Soluzione su richiesta

Jolly/KG Dorado/K

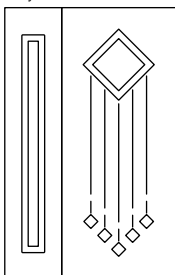

Jolly/KG1 Dorado/K1

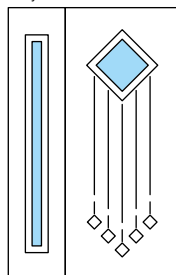

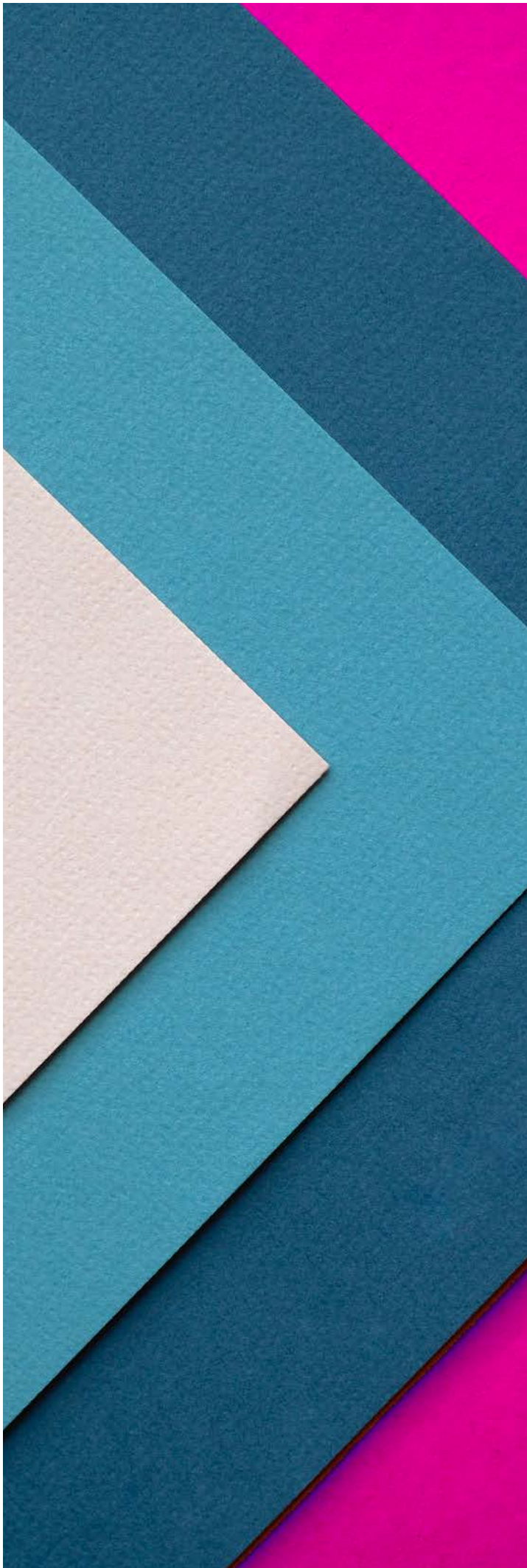

**DENEK/K**

Colore: RAL 5003 Grinz

Maniglia: A 945



Jolly/KG1 Deneb/K

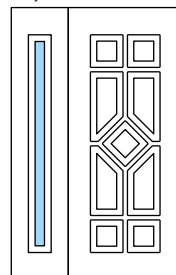

**SIGMA/K**

Colore: Porpora AK39V Grinz  
Maniglia: A 702



**SIGMA/K1**

Colore: RAL 6009 Grinz  
Vetro: decoro AC (72)  
Maniglia: A 702



INFINITY

STYLE

A FILO

EMOTION

**NOVECENTO**

INCYSO

VETRI E DECORI

MANIGLIE

PENSILINE

COLORI

SEZ. TECNICA

Jolly/KG Sigma/K

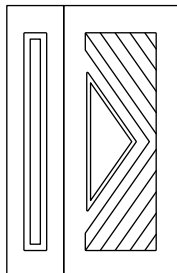

Jolly/KG1 Sigma/K1

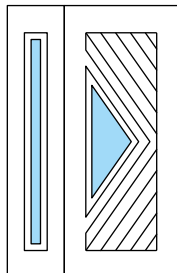



**porta ARIES/KB**

**pensilina LIBERTY mod. LT-01**

Colore: struttura Antracite P016V Grinz  
Copertura Neutro Satinato



**ARIES/K**

Colore: Melon AK37V Grinz  
Maniglia: A 518



**ARIES/KB**

Colore: Corten V001V Grinz Mix  
Maniglia: A 318



INFINITY

STYLE

A FILO

EMOTION

**NOVECENTO**

INCYSO

VETRI E DECORI

MANIGLIE

PENSILINE

COLORI

SEZ. TECNICA

Aries/KS      Aries/K

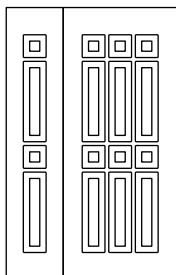

Jolly/KG1      Aries/K

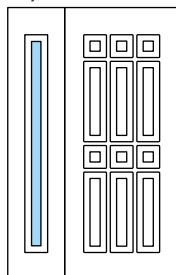

Aries/KS      Aries/KB

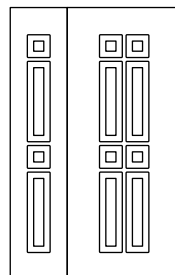



**ARIES/KC**

Colore: RAL 3003 Grinz  
Maniglia: A 622



**JOLLY/KBGM**

Colore: RAL 3005 Grinz  
Maniglia: A 945



Jolly/KBG

Aries/KC

Jolly/KBGM

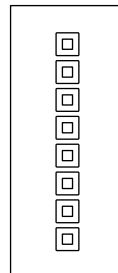
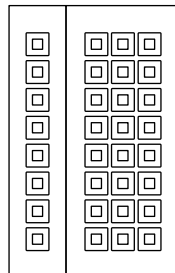

**JOLLY/KGM**

Colore: RAL 7032 Grinz  
Maniglia: A 518



**JOLLY/KGM1**

Colore: RAL 6009 Grinz  
Vetro: decoro GC (31)  
Maniglia: A 624



**JOLLY/KGM2**

Colore: RAL 6005 Grinz  
Vetro: decoro GS (31)  
Maniglia: A 622



Jolly/KGM

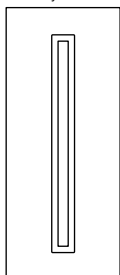

Jolly/KGM1

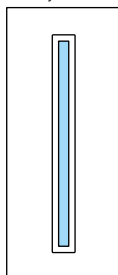

Jolly/KGM2

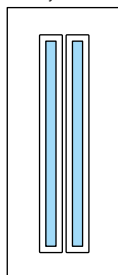

# NOVECENTO

COLLECTION

## LUCE/K1

Colore: Cemento RP103M  
 Cornice vetro: RAL 7038 Grinz\*  
 Vetro: decoro GP (77)  
 Maniglia: A 946 R

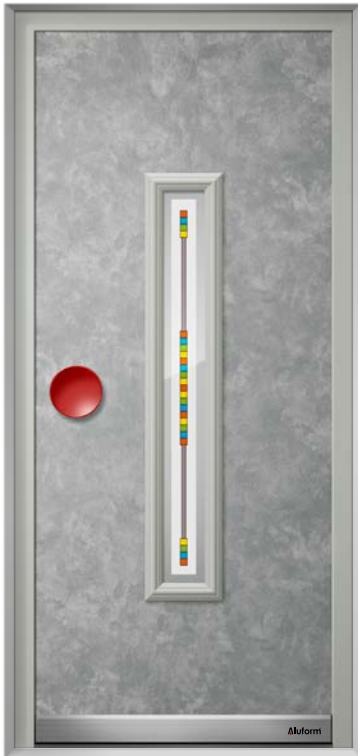

## LUCE/KE1

Colore: RAL 9007 Grinz  
 Vetro: decoro GC (36)  
 Maniglia: A 700



## LUCE/KD1

Colore: Avorio AK16V Grinz  
 Vetro: decoro GS (38)  
 Grata in acciaio Inox GI\*  
 Maniglia: A 700



Luce/KS1    Luce/K1

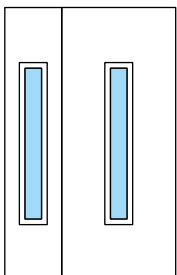

Luce/KE1

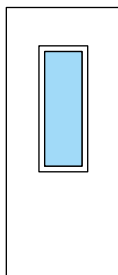

Luce/KD1

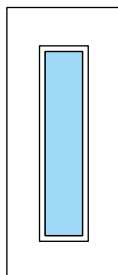

Cornice vetro  
 realizzabile  
 anche su misura

Grata Inox GI\*



Per modello Luce/KE1

**LUCE/KF3**

Colore: Corten RP101M  
Vetro: decoro RC (25)  
Maniglia: A 945



**LUCE/KH3**

Colore: RAL 8019 Grinz  
Vetro: decoro GC (40)  
Maniglia: A 951 X (RAL 8019 Grinz)



**LUCE/KH4**

Colore: Noce RP08L  
Vetro: Satinato A (40)  
Maniglia: A 961 C



\* Soluzione su richiesta

Luce/KHS3 Luce/KF3

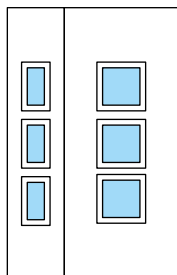

Luce/KHS3 Luce/KH3

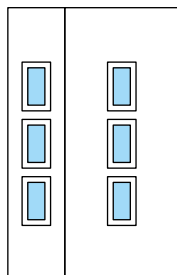

Luce/KHS4 Luce/KH4

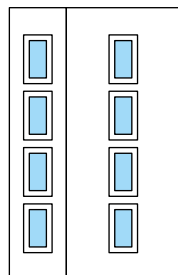

Grata Inox GI\*



Per modello Luce/KF3

# NOVECENTO

COLLECTION

## LIRA/KS

Colore: Ciliegio RP02L  
Maniglia: A 516

## LIRA/KS

Colore: Ciliegio RP02L  
Maniglia: A 516

## LIRA/KS

Colore: RAL 7032 Grinz  
Maniglia: A 518

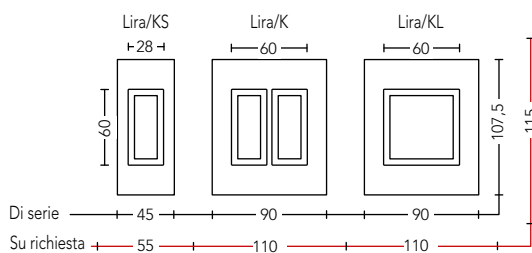
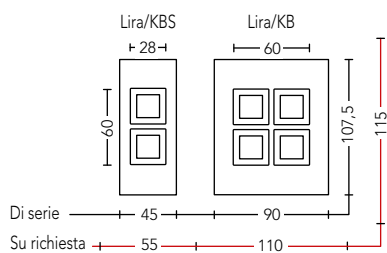

**LIRA/KCS**

Colore: Salvia  
AK11V Grinz Mix

**LIRA/KC**

Colore: Salvia AK11V Grinz Mix  
Maniglia: A 418

**LIRA/KL**

Colore: RAL 6009 Grinz  
Maniglia: A 416



INFINITY

STYLE

A FILO

EMOTION

**NOVECENTO**

INCYSO

VETRI E DECORI

MANIGLIE

PENSILINE

COLORI

SEZ. TECNICA

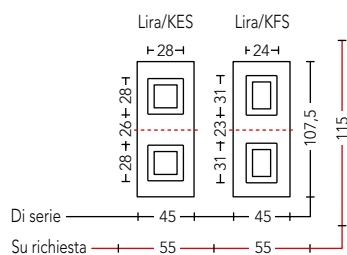
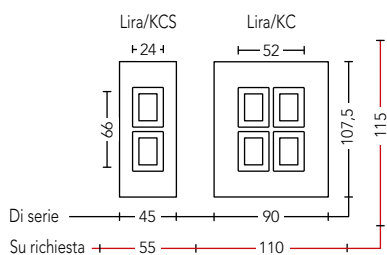

Tutti i colori effetto legno, avranno le venature disposte in senso verticale rispetto al pannello.

# CARATTERISTICHE TECNICHE

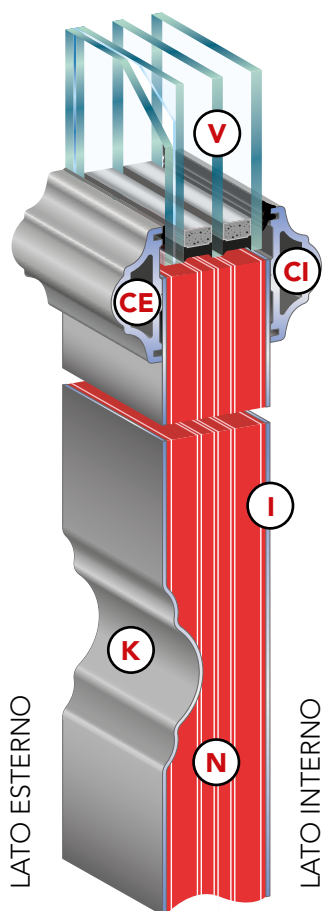

**CE - Cornice lato esterno** realizzata in alluminio estruso dello stesso colore del pannello. Su richiesta, anche di colore diverso.

**CI - Cornice lato interno** stesse caratteristiche e possibilità di personalizzazione della cornice sul lato esterno, può essere smontata e rimontata facilmente, per l'installazione e la sostituzione del vetro.

**K - Lavorazione decorativa** di mm 70 x 13 di profondità, ricavata sulla lastra di alluminio. Nei pannelli con spessore inferiore a 15 mm la profondità della lavorazione decorativa è di 5 millimetri.

**I - Lato interno liscio** realizzato di serie dello stesso colore del lato esterno. Su richiesta, colori diversi e varianti decorative come indicate sotto.

**N - Nucleo** costituito da un mix di materiali particolarmente performanti, disposti in più strati, con ottime proprietà di isolamento termico ed abbattimento acustico. Materiali e prestazioni variano in base alla tipologia e allo spessore del pannello.

**V - Vetro isolante** fornito su richiesta, realizzato con doppio o triplo vetro in base allo spessore del pannello. In entrambe le soluzioni, il vetro esterno è stratificato e quello interno temprato, in conformità alle vigenti norme sulla sicurezza. Per consentire il fissaggio della cornice interna, lo spessore del vetro deve essere inferiore di almeno 4 mm rispetto a quello del pannello.

**LATO ESTERNO**

**Esempio**

**LATO**

**INTERNO (di serie)**

**Liscio**

**VARIANTI**

**DECORATIVE LATO INTERNO (su richiesta)**

**Light**

Lavorazione "minimal" mm 13 x 2 di profondità\*

**Double**

Uguale al lato esterno



\* La lavorazione "minimal" riproduce sempre lo stesso disegno del modello esterno.



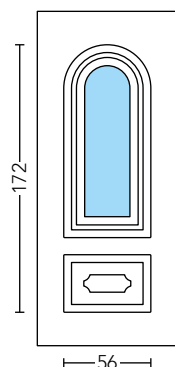

### DISEGNI E SIMBOLI

I disegni dei pannelli sono proporzionati alle dimensioni di cm 90 x 215 per l'anta principale e cm 45 x 215 per la mezza anta. Le quote indicate nei disegni (esprese in centimetri) indicano l'ingombro dell'area decorativa del modello. Con il termine area decorativa, si intende la parte lavorata del pannello che ne caratterizza il modello. L'area decorativa ha misure fisse e la sua posizione, rispetto al perimetro del pannello è sempre centrata (vedi figura in basso).

### DIMENSIONI E SPESSORI

I pannelli sono disponibili nelle dimensioni e negli spessori indicati nell'apposito capitolo tecnico. Nella scelta del modello, valutare che l'ingombro dell'area decorativa non interferisca con il profilo perimetrale in cui è alloggiato il pannello. Il margine consigliato per garantire un buon risultato estetico, è di almeno un centimetro lungo tutto il perimetro del pannello, al netto della presa dello stesso all'interno del profilo.

**Taglio a misura.** Il taglio a misura viene eseguito su richiesta, con l'area decorativa del modello centrata rispetto al perimetro del pannello (vedi figura in basso). Per esigenze particolari, ma nei limiti consentiti dall'area decorativa e dalle dimensioni richieste, il taglio a misura può essere effettuato decentrato. L'eventuale fattibilità va richiesta tramite l'invio di un disegno quotato del modello.

### LIMITAZIONI

**Verso delle venature.** Tutti i colori effetto legno, avranno le venature disposte in senso verticale rispetto al pannello.

**Pannelli nei colori legno fuori cartella.** Saranno realizzati su richiesta presso impianti esterni. Per esigenze produttive, i pannelli con queste finiture avranno dei fori lungo i bordi verticali che ne riducono la misura utile in larghezza di circa 4 cm.

Fig. 1  
area decorativa  
centrata

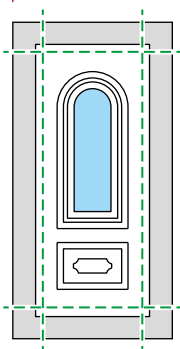

# DISEGNI

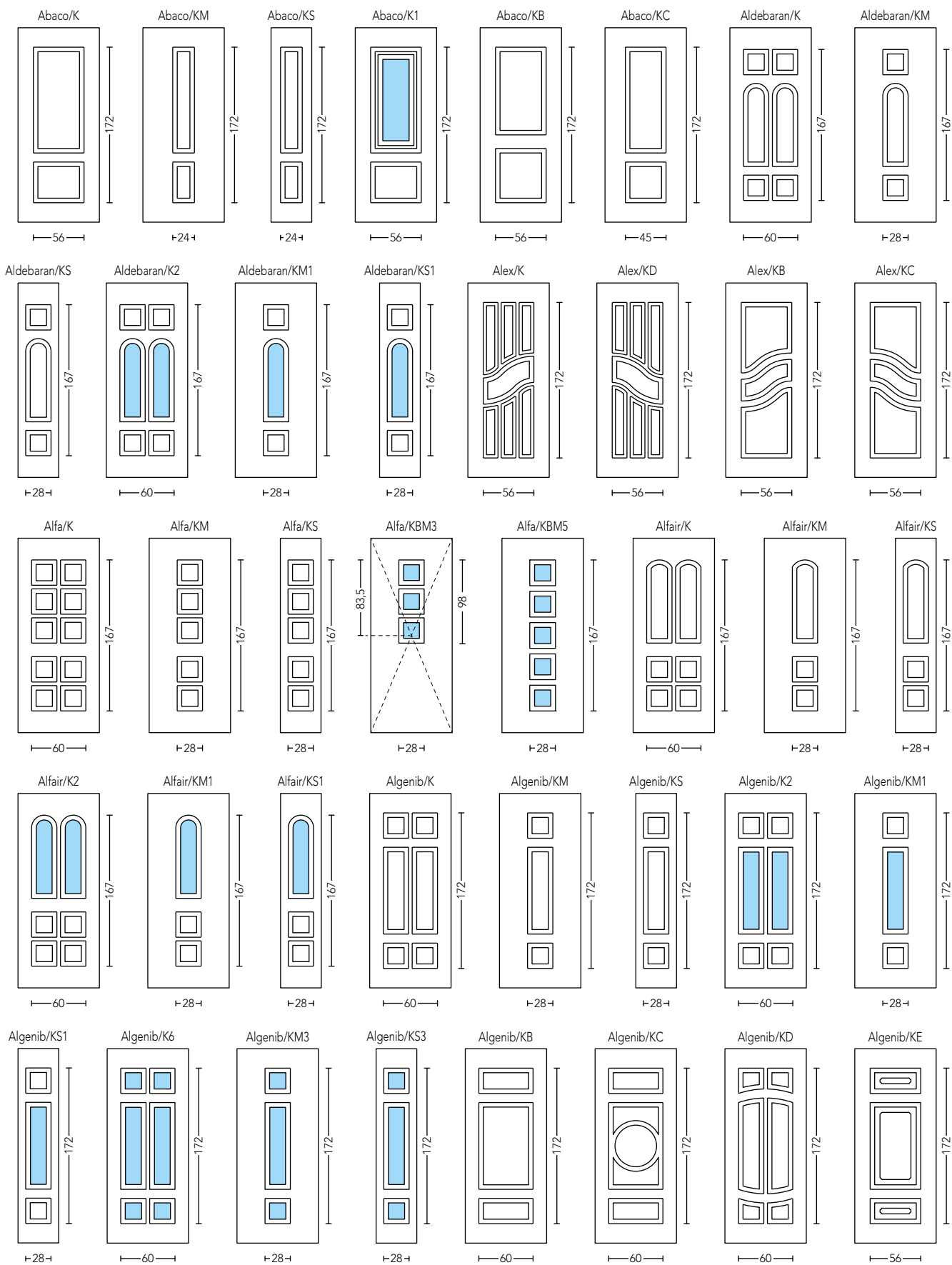

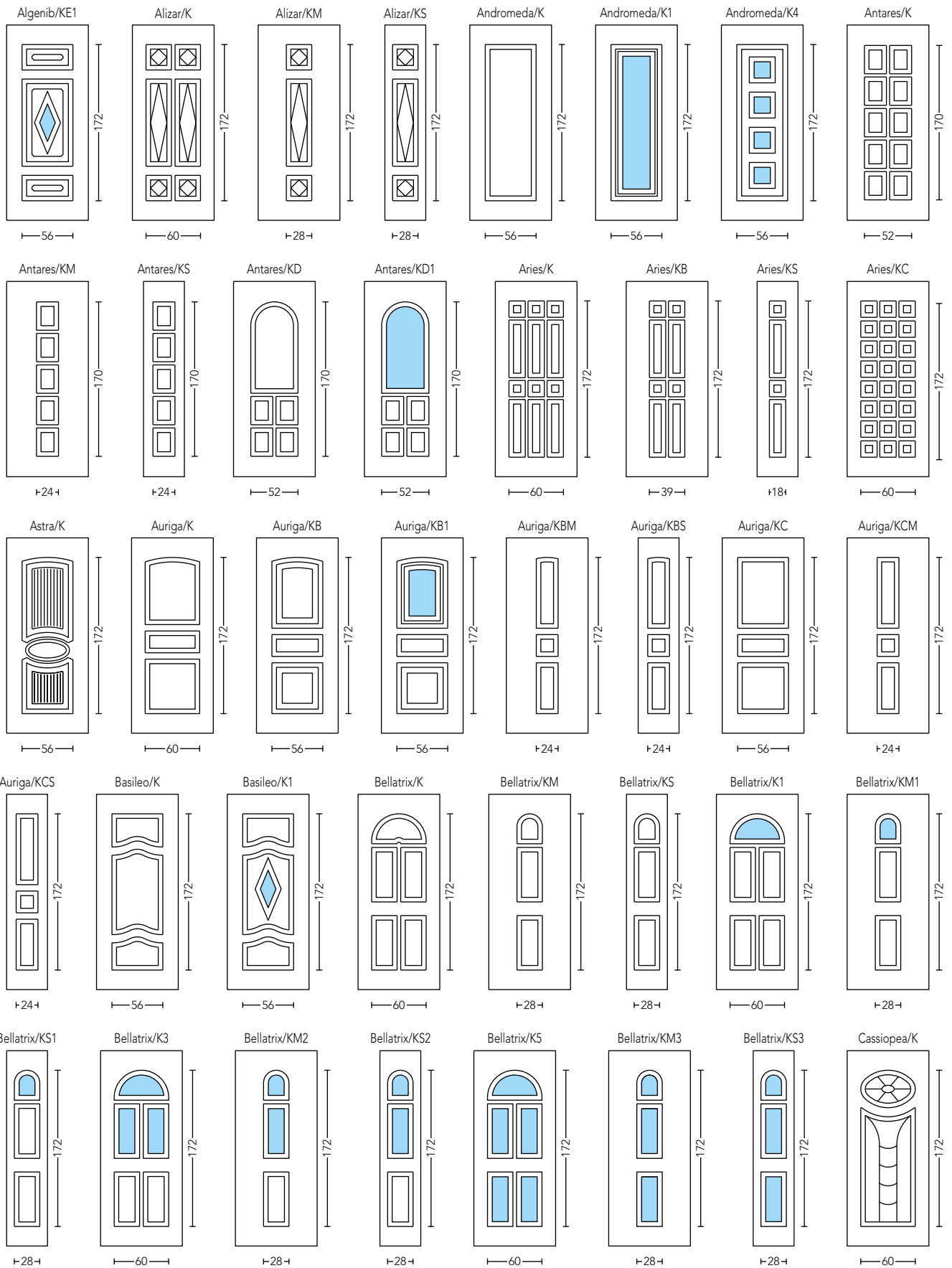

# DISEGNI

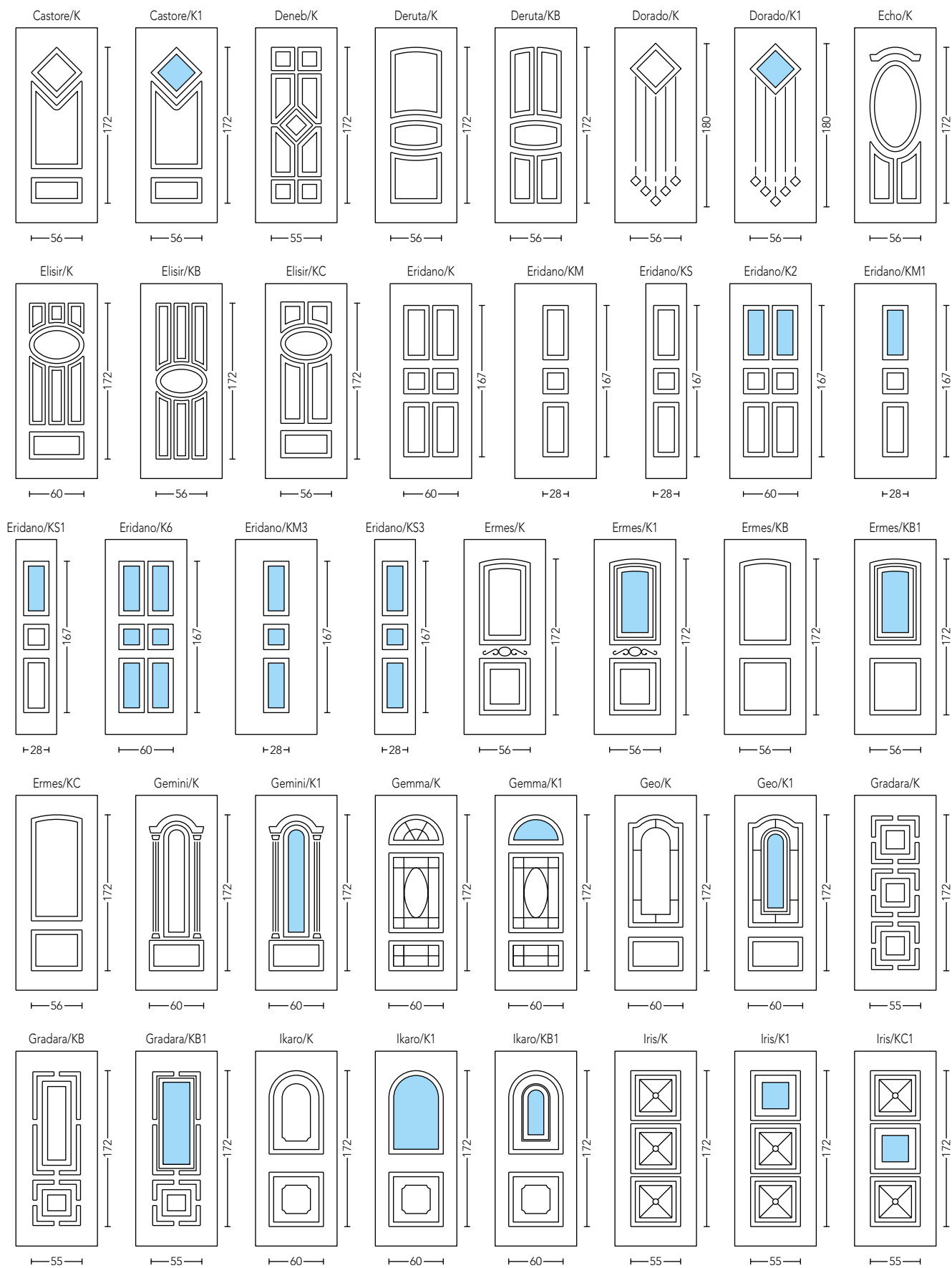

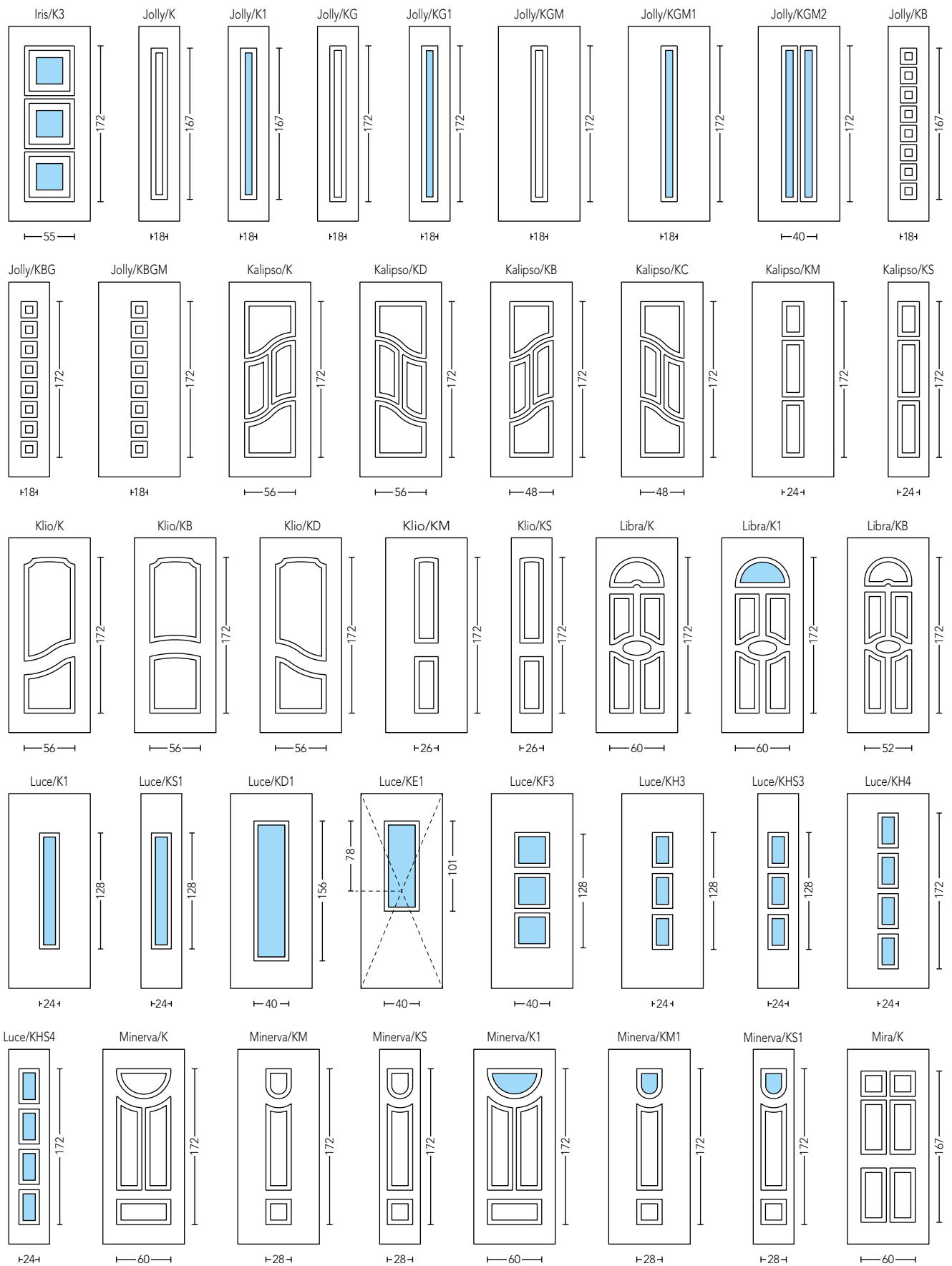

# DISEGNI

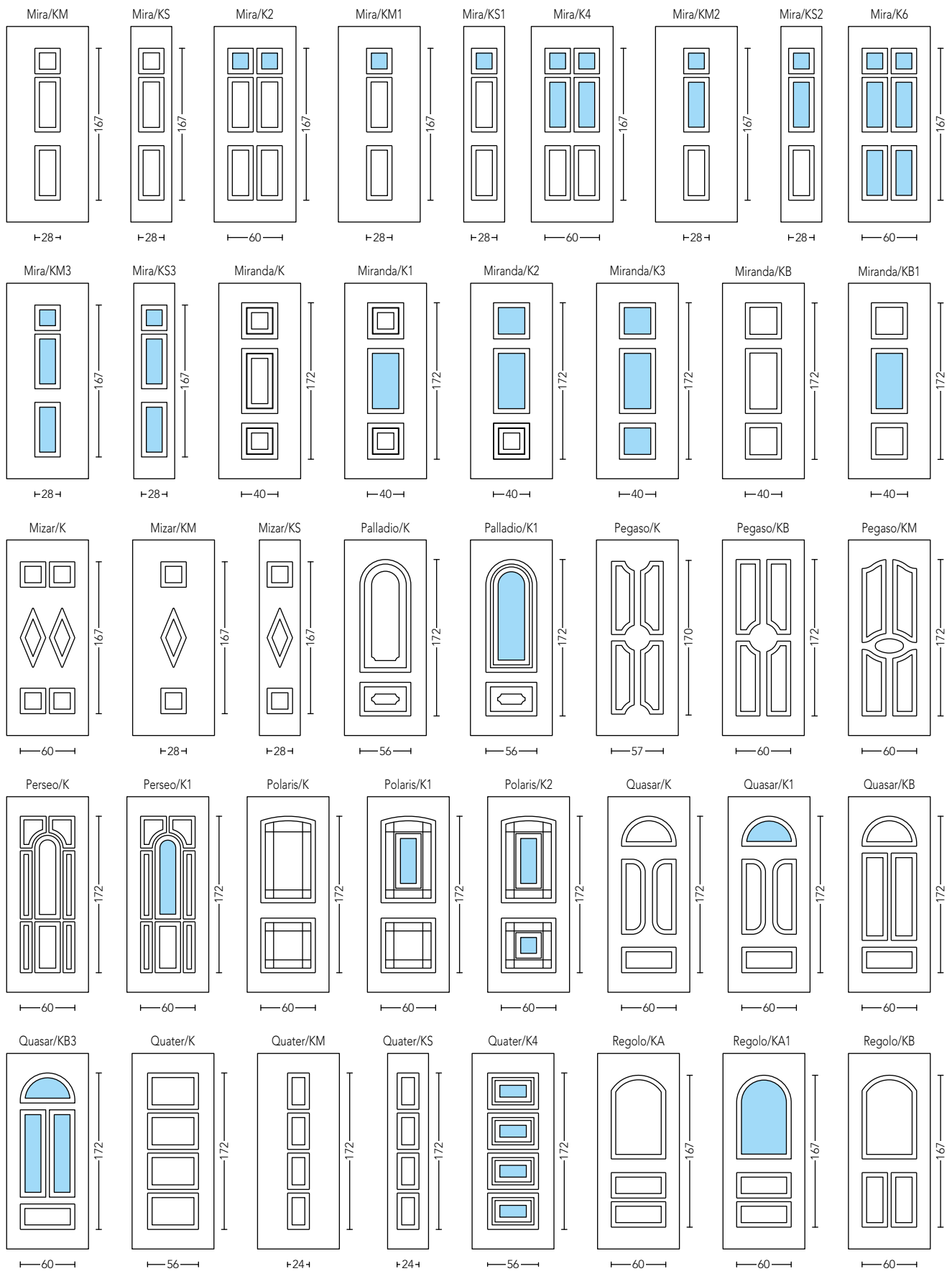

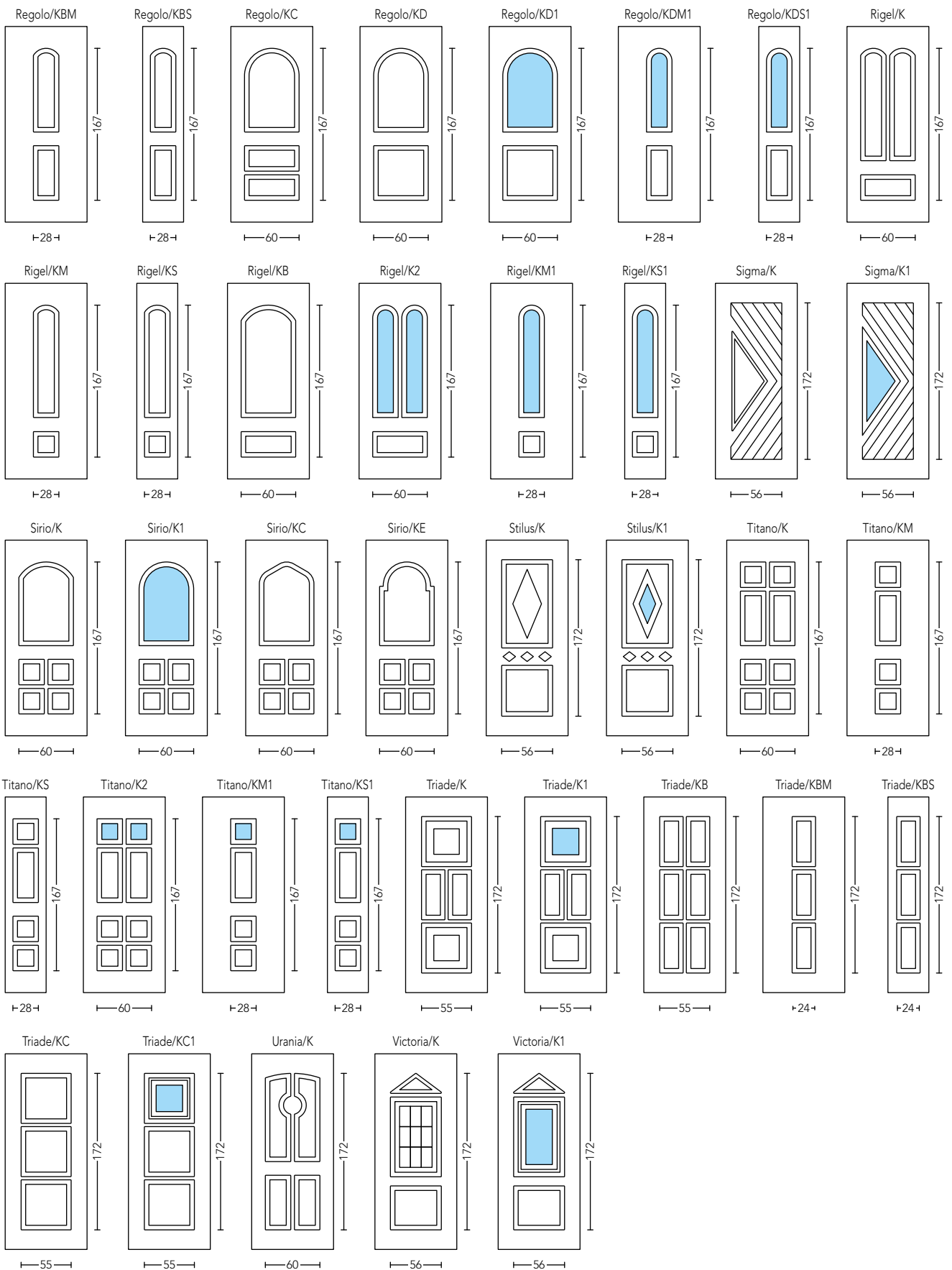







Il tuo tocco distintivo!

# INCYSO

Linee incise che disegnano forme dalla creatività che non passa inosservata e impreziosiscono i dettagli più classici con un tocco vintage. La collezione Incyso coniuga creatività, stile ed eleganza per chi ama distinguersi.

INFINITY

STYLE

A FILO

EMOTION

NOVECENTO

INCYSO

VETRI E DECORI

MANIGLIE

PENSILINE

COLORI

SEZ. TECNICA

# INDICE

**AGRY/Y**  
Pag. 448



**AGRY/YM**  
Pag. 448



**AGUS/Y**  
Pag. 438



**AGUS/YM**  
Pag. 439



**AKIRA/Y**  
Pag. 417



**ALENO/Y**  
Pag. 419



**ARMIDE/Y**  
Pag. 415



**ASSO/YM**  
Pag. 447



**BILZEN/Y**  
Pag. 418



**BRUNIDE/Y**  
Pag. 419



**CAGY/Y**  
Pag. 441



**CALT/Y**  
Pag. 436



**CALT/YB**  
Pag. 437



**CALT/YC**  
Pag. 437



**CALT/YM**  
Pag. 437



**CASER/Y**  
Pag. 440



**CASER/YM**  
Pag. 441



**CATANY/Y**  
Pag. 442



**CATANY/YB**  
Pag. 442

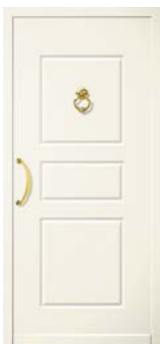

**CATANY/YM**  
Pag. 442



**DOSS/Y**  
Pag. 446



**ENNY/Y**  
Pag. 444



**ENNY/YM**  
Pag. 445



**ENTRY/Y**  
Pag. 443



**EXIT/Y**  
Pag. 433



**EXIT/YM**  
Pag. 433



**FOREST/Y**  
Pag. 413



**GORY/Y**  
Pag. 435



**IMPERY/Y**  
Pag. 445



**IRIS/Y**  
Pag. 416



**JOLLY/YGM**  
Pag. 429



**KAFFA/Y**  
Pag. 412



**KARDOA/Y**  
Pag. 414



**KESSEL/Y**  
Pag. 418



**LINE/Y**  
Pag. 423



**LINE/YB**  
Pag. 423



# INDICE

**LINE/YC**  
Pag. 422



**LODY/Y**  
Pag. 436



**MARSY/Y**  
Pag. 440



**MESSY/Y**  
Pag. 439



**MINTAKA/Y**  
Pag. 414



**MORAGA/Y**  
Pag. 417



**MORESCO/Y**  
Pag. 433



**MORESCO/YB**  
Pag. 432



**NAOS/Y**  
Pag. 413



**NASIRA/Y**  
Pag. 417



**NYSA/Y**  
Pag. 426



**OSTY/Y**  
Pag. 443



**PALER/Y**  
Pag. 439



**PERICLE/Y**  
Pag. 420



**PERICLE/YB**  
Pag. 420



**PERICLE/YC**  
Pag. 421



**PERICLE/YD**  
Pag. 421



**PERICLE/YM**  
Pag. 421



**RAGY/Y**  
Pag. 434



**ROME/Y**  
Pag. 443



**SIEN/Y**  
Pag. 436



**SILEA/Y**  
Pag. 447



**SIRA/Y**  
Pag. 445



**SORREN/Y**  
Pag. 435



**SPIGA/YA**  
Pag. 427



**SPIGA/YM**  
Pag. 427



**SPIGA/YB**  
Pag. 427



**SPIGA/YC**  
Pag. 429



**SPIGA/YCM**  
Pag. 429



**SPIGA/YD**  
Pag. 426



**SPIGA/YE**  
Pag. 427



**SPIGA/YF**  
Pag. 429



**SPIGA/YG**  
Pag. 428



**SPIGA/YGM**  
Pag. 429



**SUBRA/Y**  
Pag. 424



**SUBRA/YB**  
Pag. 425



**SUBRA/YC**  
Pag. 425



**SUBRA/YM**  
Pag. 425



**TABLET/Y**  
Pag. 430



**TACOBO/Y**  
Pag. 415



**TAOR/Y**  
Pag. 439



**TARIS/Y**  
Pag. 415



**TIFFANY/Y**  
Pag. 413



**TRAPY/Y**  
Pag. 447



**URBIS/Y**  
Pag. 445



**VARESY/Y**  
Pag. 449



**VARESY/YB**  
Pag. 449



INFINITY

STYLE

A FILO

EMOTION

NOVECENTO

INCYSO

VETRI E DECORI

MANIGLIE

PENSILINE

COLORI

SEZ. TECNICA



**JOLLY/YG**  
Colore: Porpora AK39V Grinz

**KAFFA/Y**  
Colore: Porpora AK39V Grinz  
Maniglia: A 687

**TIFFANY/Y**

Colore: RAL 6021 Grinz  
Maniglia: A 507

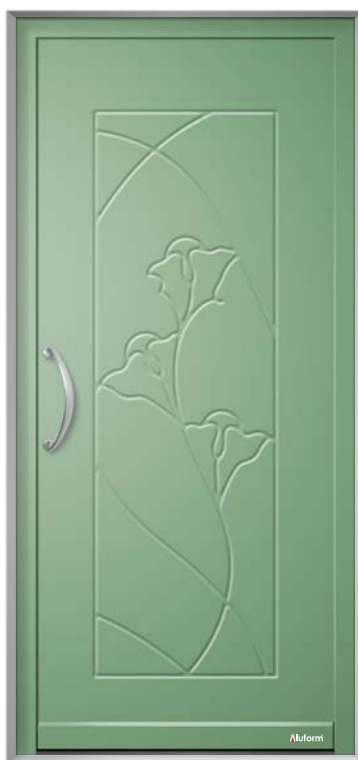

**FOREST/Y**

Colore: Corten AK10V Grinz Mix  
Maniglia: A 516



**NAOS/Y**

Colore: Orange AK38V Grinz  
Maniglia: A 705



INFINITY

STYLE

A FILO

EMOTION

NOVECENTO

**INCYSO**

VETRI E DECORI

MANIGLIE

PENSILINE

COLORI

SEZ. TECNICA

Jolly/YG      Kaffa/Y

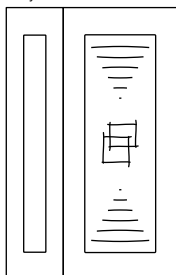

Spiga/YCS      Tiffany/Y

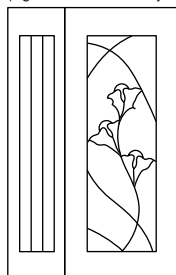

Tablet/YS      Forest/Y

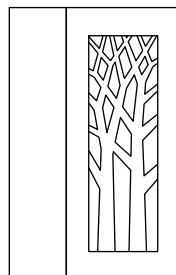

Subra/YS      Naos/Y

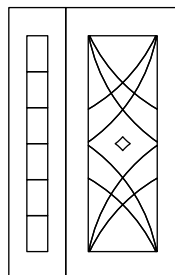

**KARDOA/Y**

Colore: Melon AK37V Grinz  
Maniglia: A 682



**MINTAKA/Y**

Colore: RAL 3003 Grinz  
Maniglia: A 703



Jolly/YG

Kardoa/Y

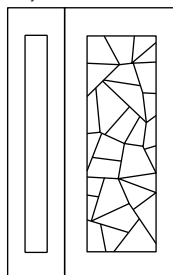

Subra/YS

Mintaka/Y

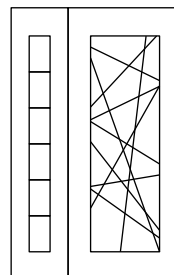



**TACOBO/Y**

Colore: RAL 3005 Grinz  
Maniglia: A 693

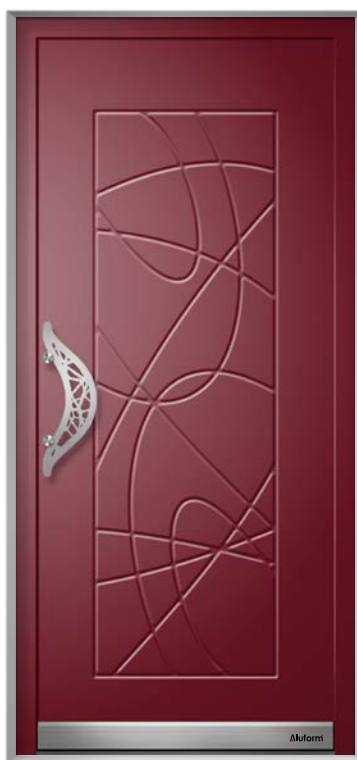

**TARIS/Y**

Colore: RAL 5003 Grinz  
Maniglia: A 941 R



**ARMIDE/Y**

Colore: RAL 5014 Grinz  
Maniglia: A 955



Jolly/YG      Tacobo/Y

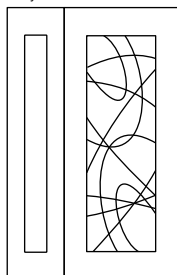

Subra/YS      Taris/Y

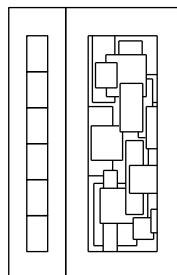

Jolly/YG      Armide/Y

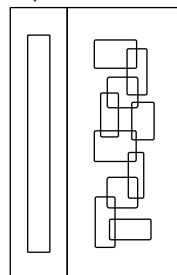



**TRIADE/YS**

Colore: RAL 7038 Grinz

**IRIS/Y**

Colore: RAL 7038 Grinz  
Maniglia: A 686

**MORAGA/Y**

Colore: RAL 6021 Grinz  
Maniglia: A 688



**NASIRA/Y**

Colore: RAL 6005 Grinz  
Maniglia: A 702



**AKIRA/Y**

Colore: RAL 6009 Grinz  
Maniglia: A 691

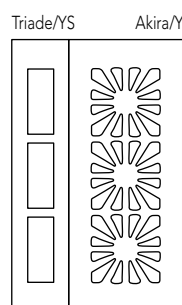
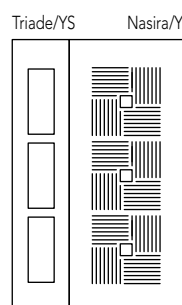
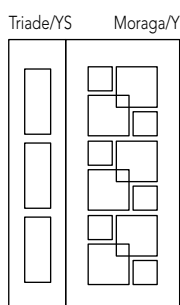
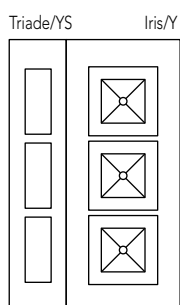

# INCYSO

COLLECTION

## KESSEL/Y

Colore: RAL 7016 Grinz  
Maniglia: A 944



## BILZEN/Y

Colore: RAL 7030 Grinz  
Maniglia: A 705



Pericle/YS Kessel/Y

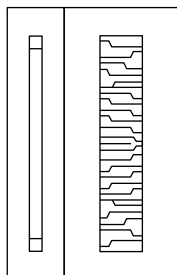

Subra/YS Bilzen/Y

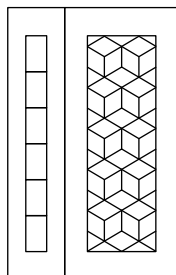

**BRUNIDE/Y**

Colore: RAL 7006 Grinz  
Maniglia: A 682



**ALENO/Y**

Colore: RAL 8017 Grinz  
Maniglia: A 702



INFINITY

STYLE

A FILO

EMOTION

NOVECENTO

**INCYSO**

VETRI E DECORI

MANIGLIE

PENSILINE

COLORI

SEZ. TECNICA

Subra/YS    Brunide/Y

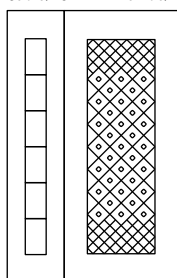

Jolly/YG    Aleno/Y

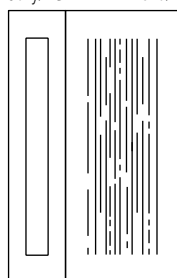

**PERICLE/Y**

Colore: RAL 7038 Grinz  
Maniglia: A 961 R



**PERICLE/YB**

Colore: RAL 7011 Grinz  
Maniglia: A 415



Pericle/YS Pericle/Y

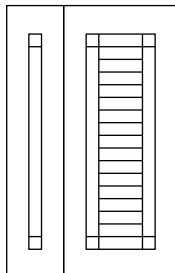

Pericle/YS Pericle/YB

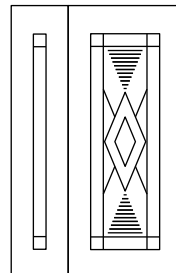

**PERICLE/YC**

Colore: Ciliegio RP03L  
Maniglia: A 946



**PERICLE/YD**

Colore: Ciliegio RP02L  
Maniglia: A 687



**PERICLE/YM**

Colore: Noce RP07L  
Maniglia: A 941



Pericle/YS Pericle/YC

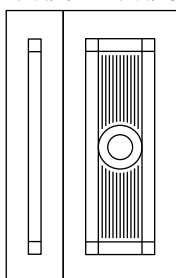

Pericle/YS Pericle/YD

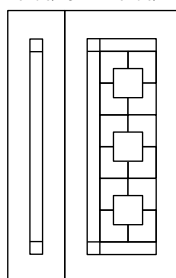

Pericle/YM

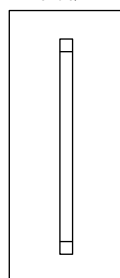



97

Aluform

numero civico NC...  
Placca + 2 cifre

porta LINE/YC  
Colore: RAL 5014 Grinz  
Maniglia: A 682



**LINE/Y**

Colore: RAL 3003 Grinz  
Maniglia: A 705



**LINE/YB**

Colore: RAL 5010 Grinz  
Maniglia: A 703



INFINITY

STYLE

A FILO

EMOTION

NOVECENTO

**INCYSO**

VETRI E DECORI

MANIGLIE

PENSILINE

COLORI

SEZ. TECNICA

Subra/YS Line/YC

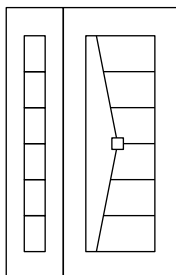

Subra/YS Line/Y

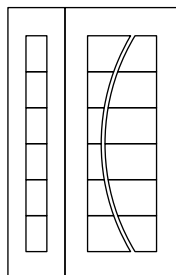

Jolly/YG Line/YB

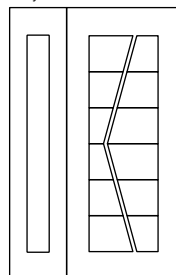



**SUBRA/YS**  
Colore: Antracite P016V Grinz

**SUBRA/Y**  
Colore: Antracite P016V Grinz  
Maniglia: A 942

**SUBRA/Y**

Colore: RAL 7035 Grinz  
Maniglia: A 941 N



**SUBRA/YB**

Colore: RAL 7038 Grinz  
Maniglia: A 943



**SUBRA/YC**

Colore: RAL 7030 Grinz  
Maniglia: A 971 R



INFINITY

STYLE

A FILO

EMOTION

NOVECENTO

**INCYSO**

VETRI E DECORI

MANIGLIE

PENSILINE

COLORI

SEZ. TECNICA

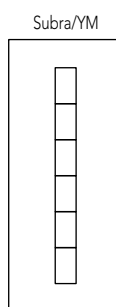
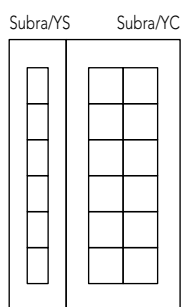
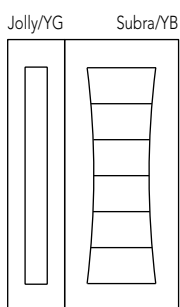
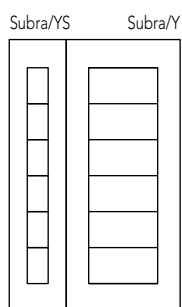



**NYSA/Y**

Colore: RAL 8017 Grinz  
Maniglia: A 682



**SPIGA/YD**

Colore: RAL 7004 Grinz  
Maniglia: A 682



Jolly/YG

Nysa/Y

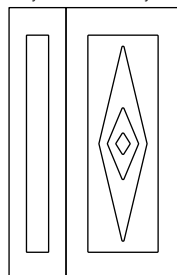

Spiga/YCS

Spiga/YD

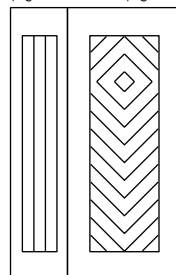

**SPIGA/YE**

Colore: RAL 3005 Grinz  
Maniglia: A 624



**SPIGA/YA**

Colore: RAL 9010 Grinz  
Maniglia: A 416



**SPIGA/YM**

Colore: Rovere grigio RP10L  
Maniglia: A 618



Spiga/YAS Spiga/YE

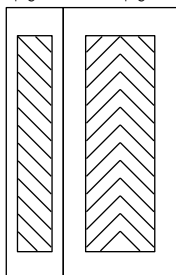

Spiga/YAS Spiga/YA

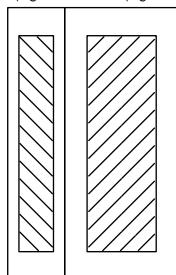

Spiga/YS Spiga/YB

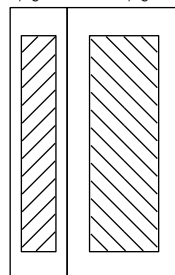

Spiga/YAM

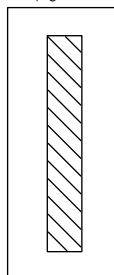

Spiga/YM

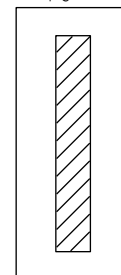



**SPIGA/YGS**  
Colore: Rame bugnato AK02V

**SPIGA/YG**  
Colore: Rame bugnato AK02V  
Maniglia: A 624

**SPIGA/YF**

Colore: Orange AK38V Grinz  
Maniglia: A 680



**SPIGA/YC**

Colore: RAL 9007 Grinz  
Maniglia: A 963



**JOLLY/YGM**

Colore: Bleu AK15V Grinz  
Maniglia: A 941 N



INFINITY

STYLE

A FILO

EMOTION

NOVECENTO

**INCYSO**

VETRI E DECORI

MANIGLIE

PENSILINE

COLORI

SEZ. TECNICA

Spiga/YGS Spiga/YG

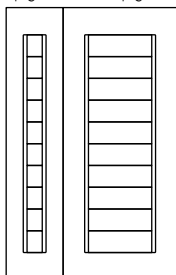

Spiga/YGM

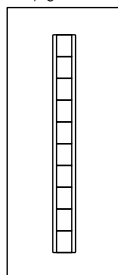

Pericle/YS Spiga/YF

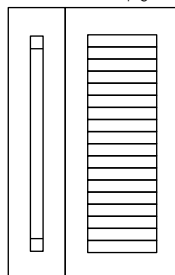

Spiga/YCS Spiga/YC

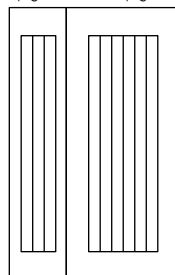

Spiga/YCM

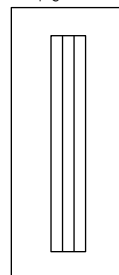

Jolly/YGM

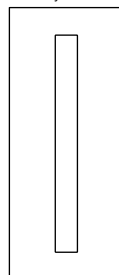

Jolly/YG

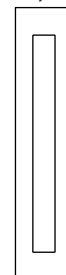



**TABLET/YS**  
Colore: Bleu AK15V Grinz

**TABLET/Y**  
Colore: Bleu AK15V Grinz  
Maniglia: A 955 R



**TABLET/Y**

Colore: Corten RP101M  
Maniglia: A 943



**TABLET/Y**

Colore: Ghisa RP102M  
Maniglia: A 944

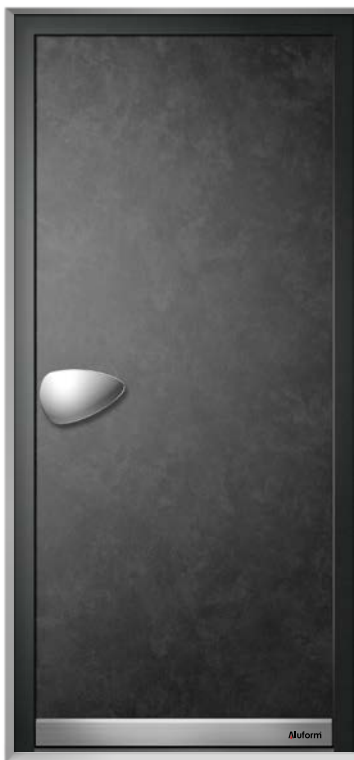

**TABLET/Y**

Colore: Cemento RP103M  
Maniglia: A 941 N

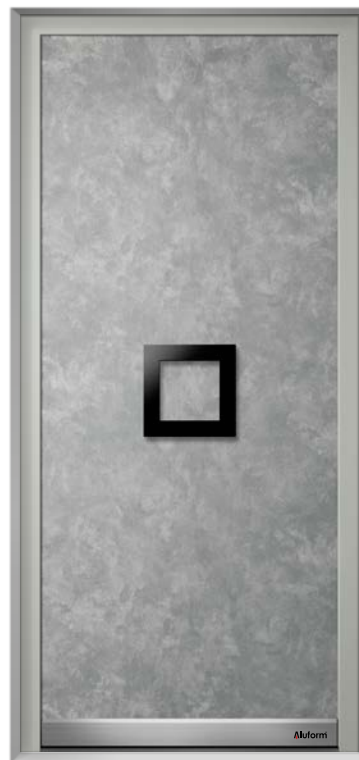

INFINITY

STYLE

A FILO

EMOTION

NOVECENTO

**INCYSO**

VETRI E DECORI

MANIGLIE

PENSILINE

COLORI

SEZ. TECNICA

Tablet/YS      Tablet/Y

--	--



**MORESCO/YB**  
Colore: Verde P7100 Mix  
Maniglia: A 507

**MORESCO/Y**

Colore: RAL 5014 Grinz  
Maniglia: A 507



**MORESCO/YB**

Colore: RAL 6021 Grinz  
Maniglia: A 407



**EXIT/Y**

Colore: RAL 7005 Grinz  
Maniglia: A 687



INFINITY

STYLE

A FILO

EMOTION

NOVECENTO

**INCYSO**

VETRI E DECORI

MANIGLIE

PENSILINE

COLORI

SEZ. TECNICA

Tablet/YS    Moresco/Y

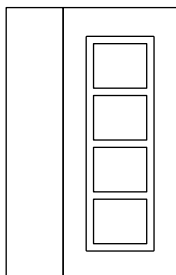

Jolly/YG    Moresco/YB

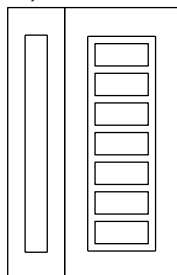

Exit/YS    Exit/Y

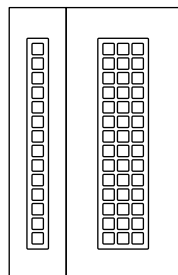

Exit/YM

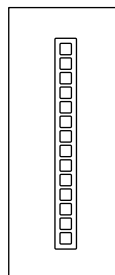



**ASSO/YS**

Colore: Nussbaum V 2178 007-167

**RAGY/Y**

Colore: Nussbaum V 2178 007-167

Maniglia: A 407

Battente: A 425

**RAGY/Y**

Colore: Eiche Hell 2052 090-167  
Maniglia: A 514  
Battente: A 525



**SORREN/Y**

Colore: RAL 7006 Grinz  
Maniglia: A 570  
Battente: A 540



**GORY/Y**

Colore: Avorio AK16V Grinz  
Maniglia: A 415  
Battente: A 422

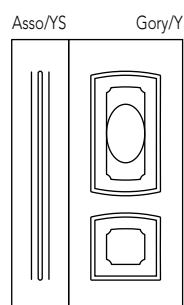
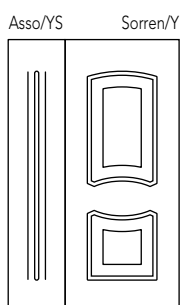
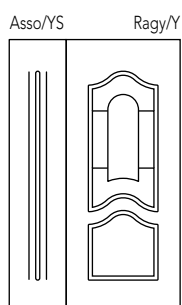

**INCYSO**  
COLLECTION

**LODY/Y**

Colore: RAL 7038 Grinz  
Maniglia: A 407  
Battente: A 425

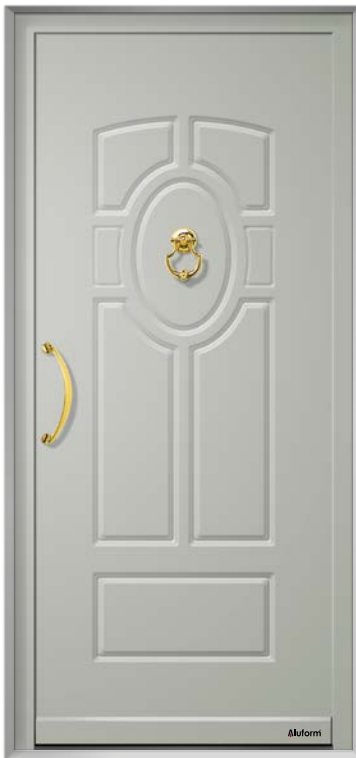

**SIEN/Y**

Colore: RAL 6021 Grinz  
Maniglia: A 509  
Battente: A 540



**CALT/Y**

Colore: Salvia AK11V Grinz Mix  
Maniglia: A 507

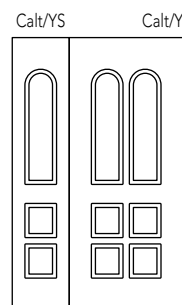
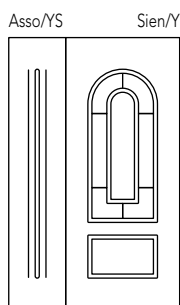
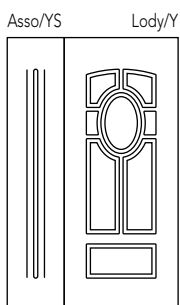
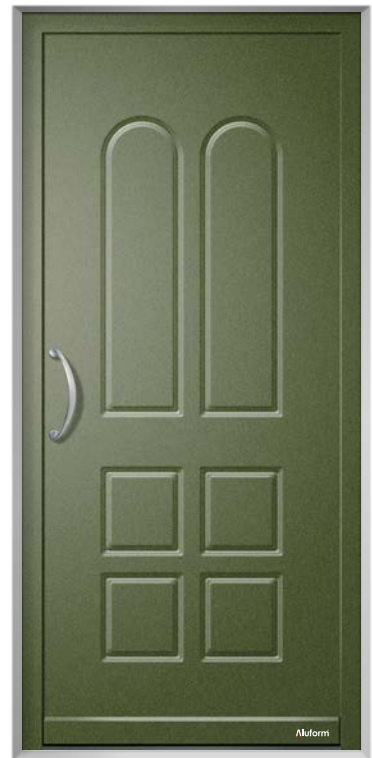

**CALT/YB**

Colore: RAL 5014 Grinz  
Maniglia: A 516  
Battente: A 525



**CALT/YC**

Colore: RAL 5010 Grinz  
Maniglia: A 518  
Battente: A 520



**CALT/YM**

Colore: RAL 5003 Grinz  
Maniglia: A 691

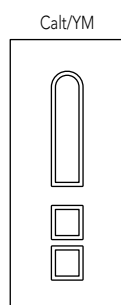
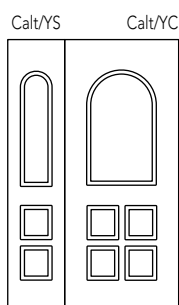
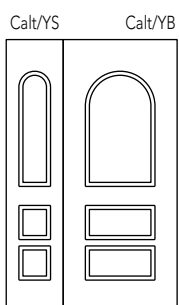



**AGUS/YS**  
Colore: Black Cherry 3202 001-167

**AGUS/Y**  
Colore: Black Cherry 3202 001-167  
Maniglia: A 518



**PALER/Y**

Colore: RAL 8014 Grinz  
Maniglia: A 509  
Battente: A 540



**MESSY/Y**

Colore: RAL 8017 Grinz  
Maniglia: A 516  
Battente: A 522



**TAOR/Y**

Colore: RAL 8019 Grinz  
Maniglia: A 946 N

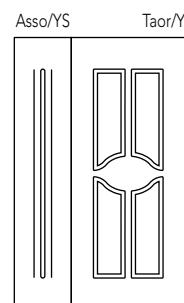
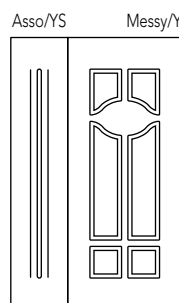
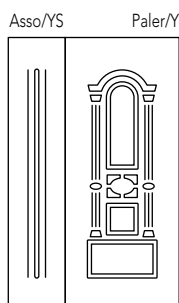
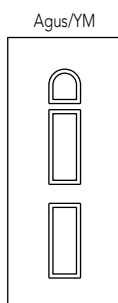
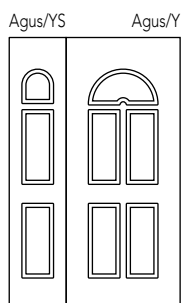

**INCYSO**  
COLLECTION

**MARSY/Y**

Colore: RAL 3005 Grinz  
Maniglia: A 517



**CASER/Y**

Colore: RAL 6009 Grinz  
Maniglia: A 470  
Battente: A 440

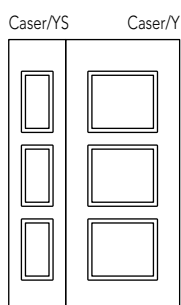
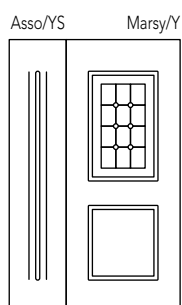

**CASER/YM**

Colore: Salvia AK11V Grinz Mix  
Maniglia: A 509  
Battente: A 540

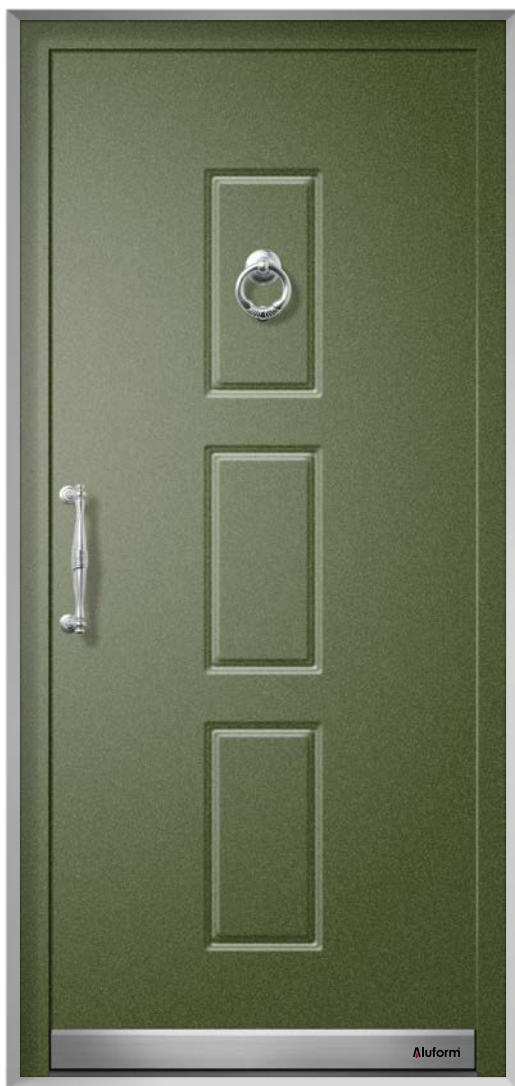

**CAGY/Y**

Colore: RAL 6021 Grinz  
Maniglia: A 406  
Battente: A 422



INFINITY

STYLE

A FILO

EMOTION

NOVECENTO

**INCYSO**

VETRI E DECORI

MANIGLIE

PENSILINE

COLORI

SEZ. TECNICA

Caser/YM

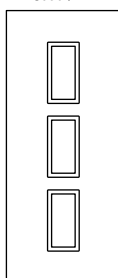

Caser/YS

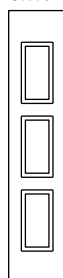

Cagy/Y

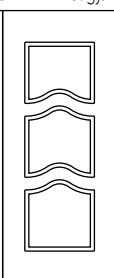

**CATANY/Y**

Colore: Bronzo TR03V Grinz  
Maniglia: A 307

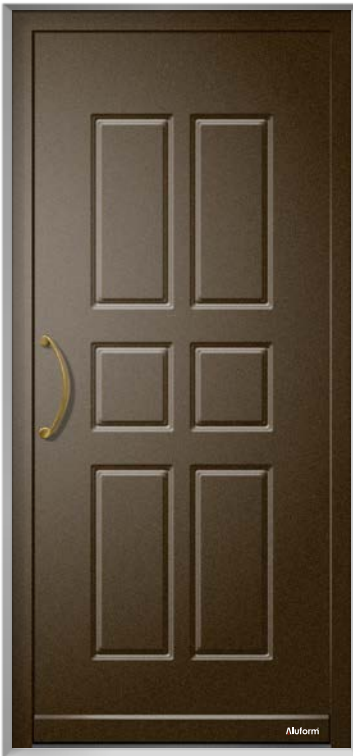

**CATANY/YM**

Colore: RAL 7044 Grinz  
Maniglia: A 307  
Battente: A 325



**CATANY/YB**

Colore: RAL 9010 Grinz  
Maniglia: A 407  
Battente: A 425



Catany/YS    Catany/Y

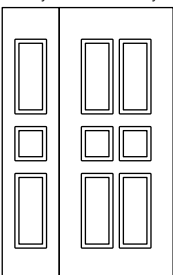

Catany/YM

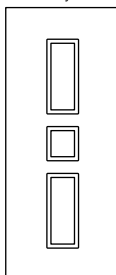

Catany/YS    Catany/YB

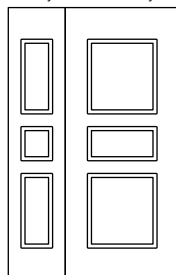

**ROME/Y**

Colore: RAL 7004 Grinz  
Maniglia: A 945 R



**OSTY/Y**

Colore: RAL 7011 Grinz  
Maniglia: A 518  
Battente: A 522



**ENTRY/Y**

Colore: Antracite P016V Grinz  
Maniglia: A 515

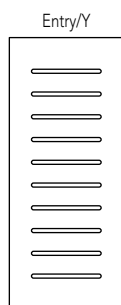
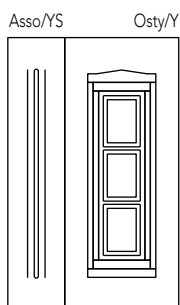
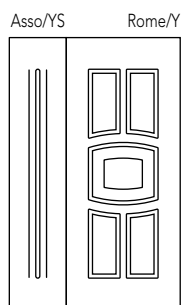



numero civico NC...  
placca + 3 cifre

porta ENNY/Y  
Colore: RAL 5010 Grinz  
Maniglia: A 514

**URBIS/Y**

Colore: Ciliegio RP03L  
Maniglia: A 508



**SIRA/Y**

Colore: Ciliegio RP02L  
Maniglia: A 414  
Battente: A 440



**IMPERY/Y**

Colore: Noce RP07L  
Maniglia: A 407

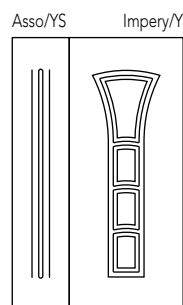
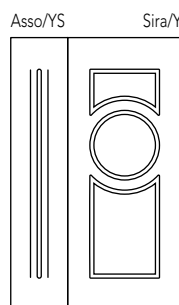
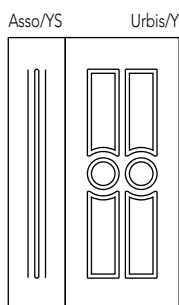
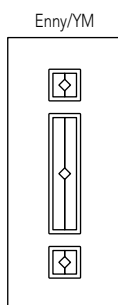
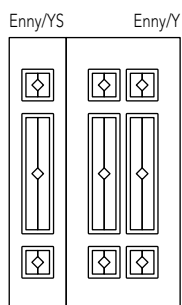

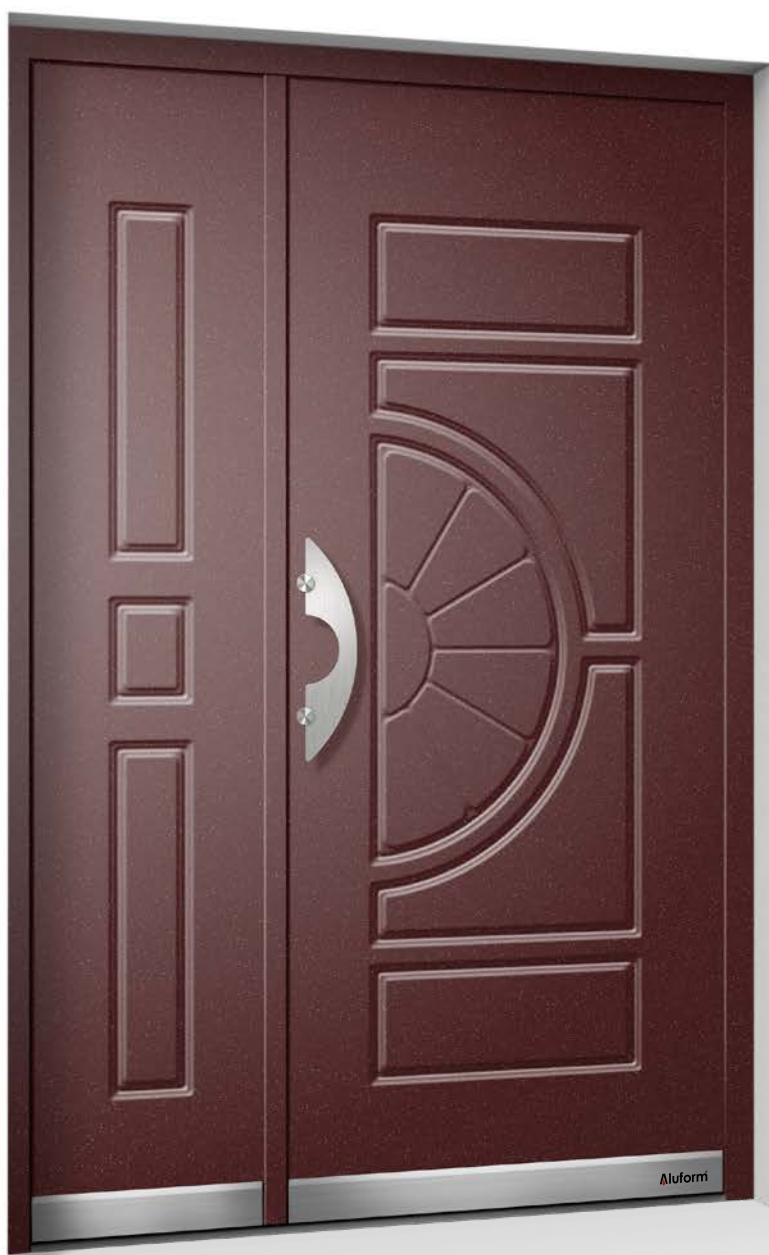

**VARESY/YS**  
Colore: Rosso P7300 Mix

**DOSS/Y**  
Colore: Rosso P7300 Mix  
Maniglia: A 691



**SILEA/Y**

Colore: RAL 3005 Grinz  
Maniglia: A 700

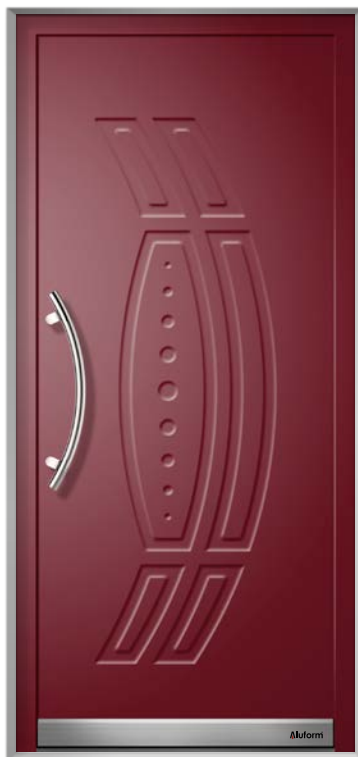

**TRAPY/Y**

Colore: RAL 3003 Grinz  
Maniglia: A 945



**ASSO/YM**

Colore: RAL 5003 Grinz  
Maniglia: A 624



Varesy/YS Doss/Y

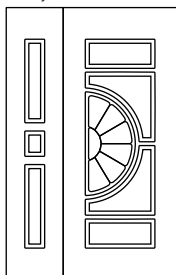

Asso/YS Silea/Y

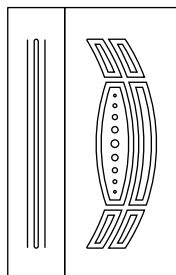

Asso/YS Trapy/Y

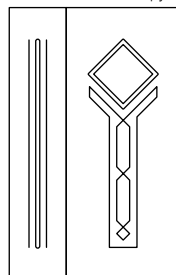

Asso/YM

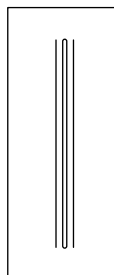

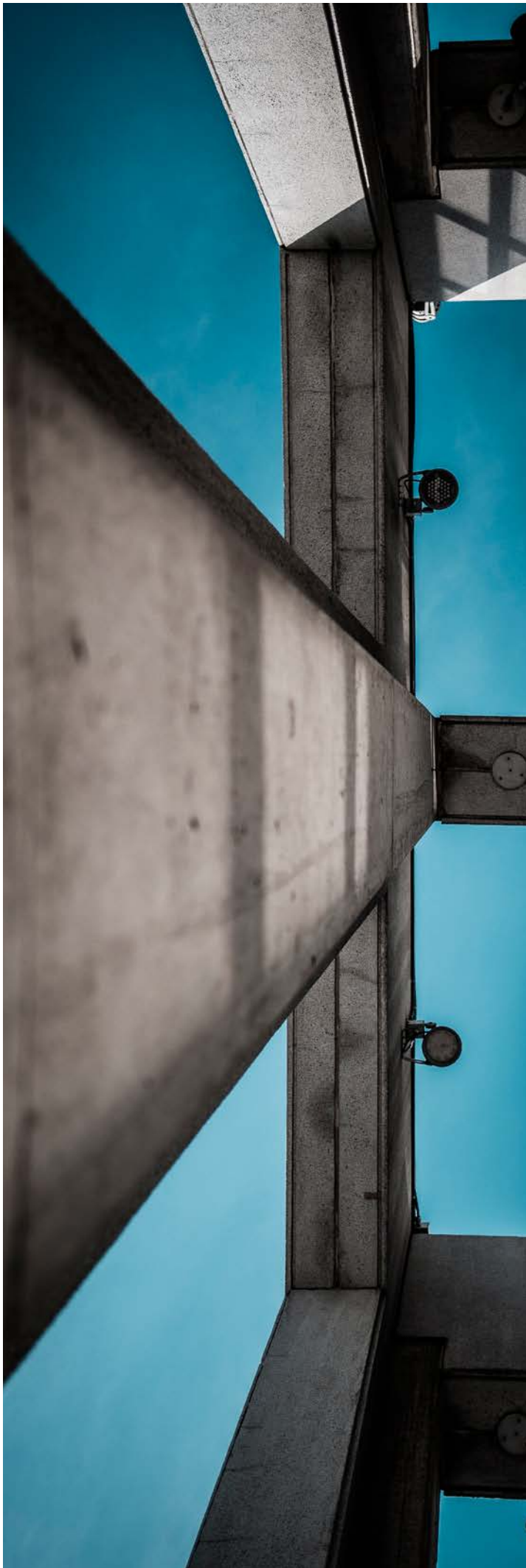

**AGRY/Y**

Colore: RAL 5003 Grinz

Maniglia: A 517



Agry/YS



Agry/Y

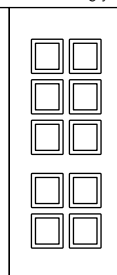

Agry/YM

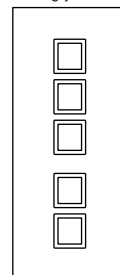

**VARESY/Y**

Colore: RAL 5010 Grinz  
Maniglia: A 516



**VARESY/YB**

Colore: RAL 7040 Grinz  
Maniglia: A 514



INFINITY

STYLE

A FILO

EMOTION

NOVECENTO

**INCYSO**

VETRI E DECORI

MANIGLIE

PENSILINE

COLORI

SEZ. TECNICA

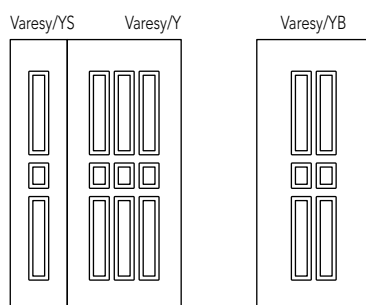

# SINTESI TECNICA

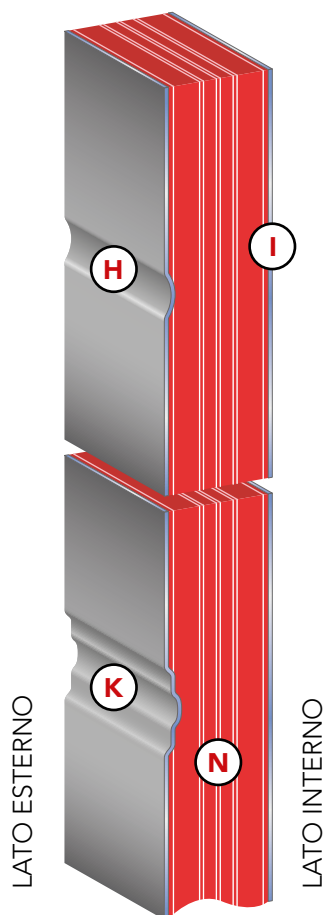

**H - Lavorazione decorativa** di mm 13 x 2 di profondità, ricavata sulla lastra di alluminio.

**K - Lavorazione decorativa** di mm 30 x 4 di profondità, ricavata sulla lastra di alluminio.

**I - Lato interno liscio**, realizzato di serie dello stesso colore del lato esterno. Su richiesta, colori diversi e variante decorativa come indicata sotto.

**N - Nucleo** costituito da un mix di materiali particolarmente performanti, disposti in più strati, con ottime proprietà di isolamento termico ed abbattimento acustico. Materiali e prestazioni variano in base alla tipologia e allo spessore del pannello.

**LATO**  
ESTERNO

**Esempio**

**LATO**  
INTERNO (di serie)

**Liscio**

**VARIANTE**  
DECORATIVA LATO INTERNO (su richiesta)

**Double**

Uguale al lato esterno



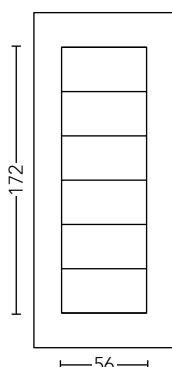

### DISEGNI E SIMBOLI

I disegni dei pannelli sono proporzionati alle dimensioni di cm 90 x 215 per l'anta principale e cm 45 x 215 per la mezza anta. Le quote indicate nei disegni (esprese in centimetri) indicano l'ingombro dell'area decorativa del modello. Con il termine area decorativa, si intende la parte lavorata del pannello che ne caratterizza il modello. L'area decorativa ha misure fisse e la sua posizione, rispetto al perimetro del pannello è sempre centrata (vedi figura in basso).

### DIMENSIONI E SPESSORI

I pannelli sono disponibili nelle dimensioni e negli spessori indicati nell'apposito capitolo tecnico. Nella scelta del modello, valutare che l'ingombro dell'area decorativa non interferisca con il profilo perimetrale in cui è alloggiato il pannello. Il margine consigliato per garantire un buon risultato estetico, è di almeno un centimetro lungo tutto il perimetro del pannello, al netto della presa dello stesso all'interno del profilo.

**Taglio a misura.** Il taglio a misura viene eseguito su richiesta, con l'area decorativa del modello centrata rispetto al perimetro del pannello (vedi figura in basso). Per esigenze particolari, ma nei limiti consentiti dall'area decorativa e dalle dimensioni richieste, il taglio a misura può essere effettuato decentrato. L'eventuale fattibilità va richiesta tramite l'invio di un disegno quotato del modello.

### LIMITAZIONI

**Verso delle venature.** Tutti i colori effetto legno, avranno le venature disposte in senso verticale rispetto al pannello.

**Pannelli nei colori legno fuori cartella.** Saranno realizzati su richiesta presso impianti esterni. Per esigenze produttive, i pannelli con queste finiture avranno dei fori lungo i bordi verticali che ne riducono la misura utile in larghezza di circa 4 cm.

Fig. 1  
area decorativa  
centrata

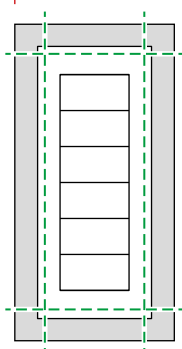

# DISEGNI

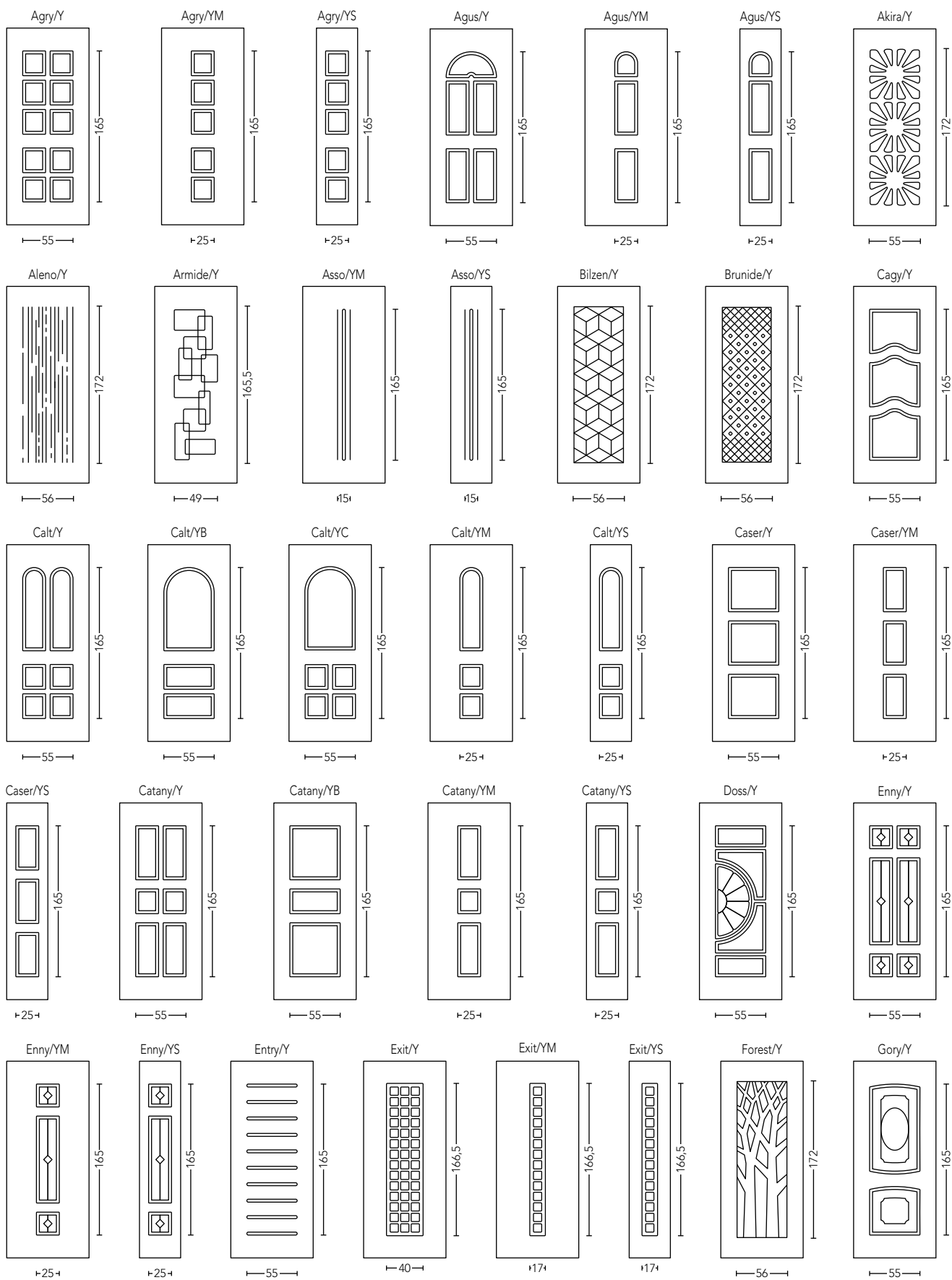

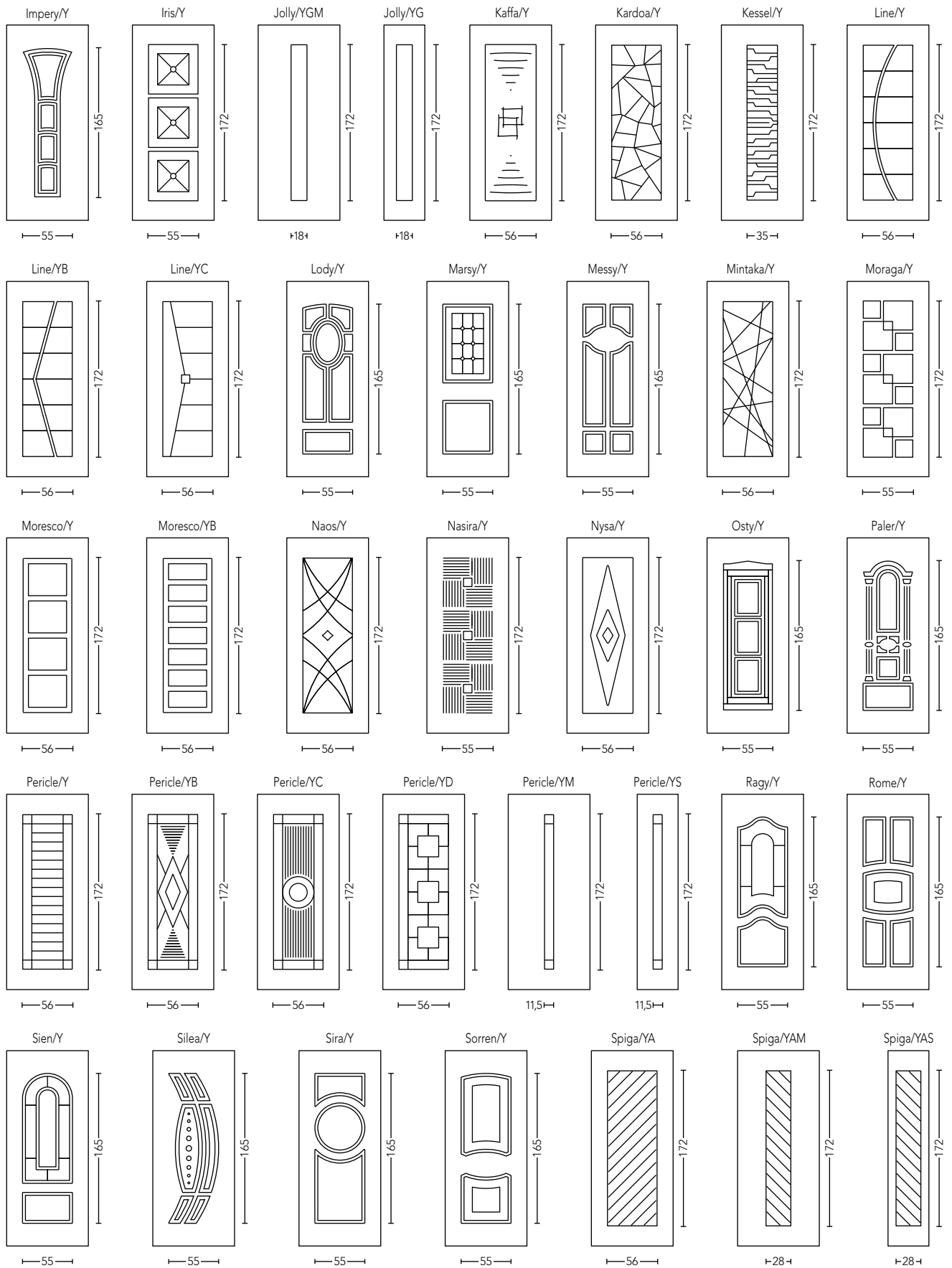

# DISEGNI

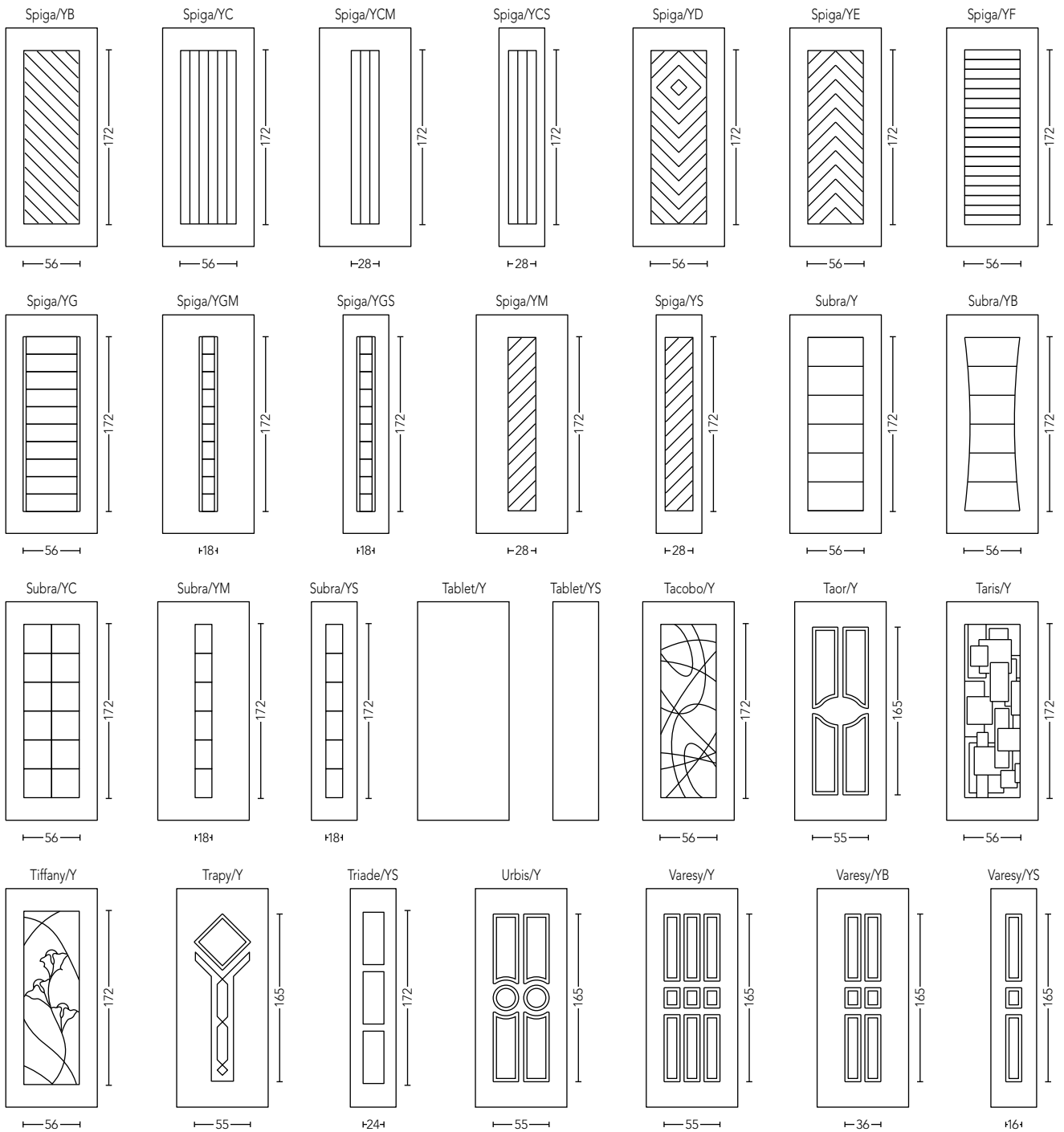



INFINITY

STYLE

A FILO

EMOTION

NOVECENTO

**INCYSO**

VETRI E DECORI

MANIGLIE

PENSILINE

COLORI

SEZ. TECNICA

# VETRI E DECORI

## La raffinatezza del segno artistico!

Tante le opzioni a disposizione tra cui scegliere in armonia con lo spazio circostante. Satinati, riflettenti, disegnati o pieni di colore, sono il tocco che fa la differenza e arreda con gusto.

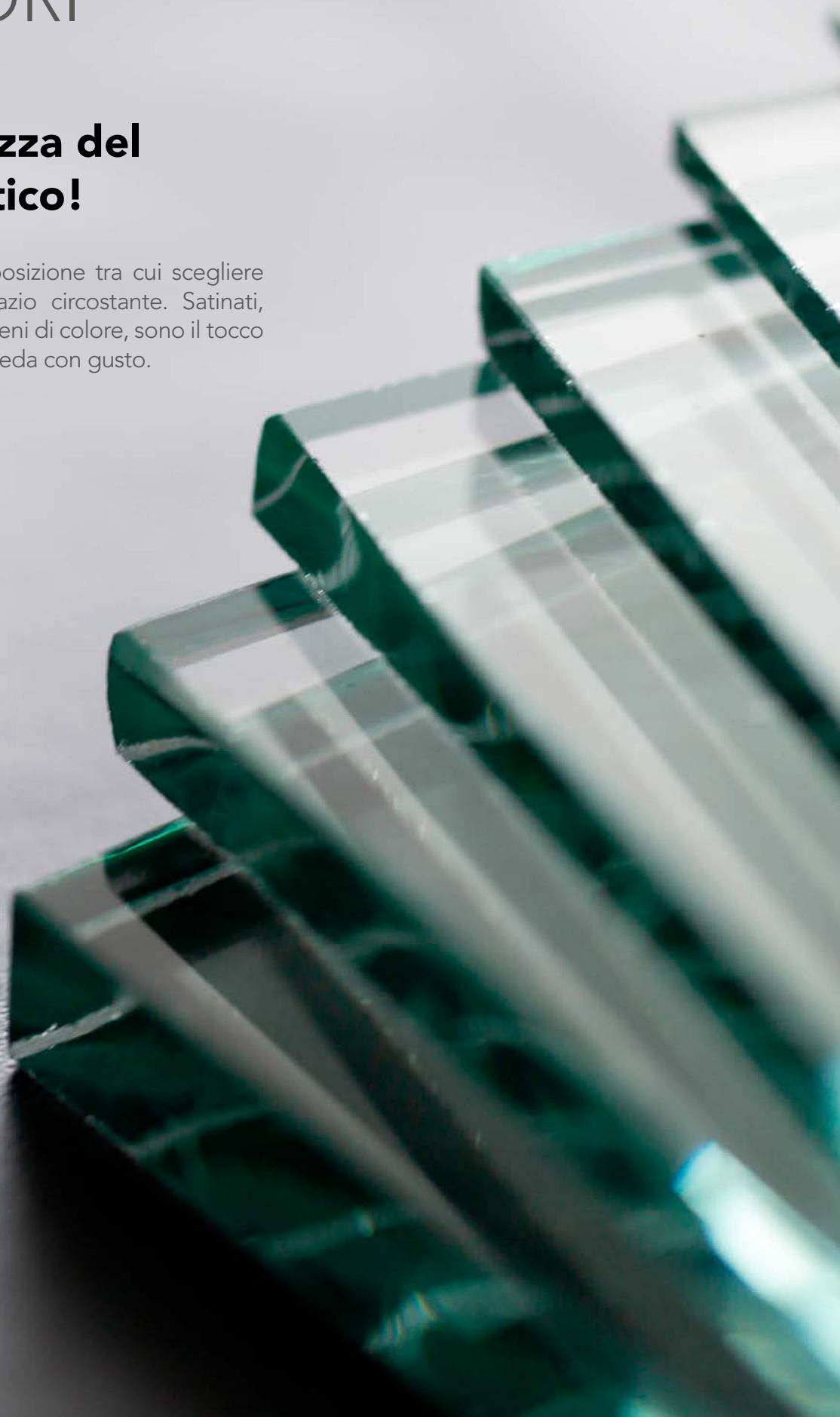

## VETRI SOSTITUIBILI NON INTEGRATI

La possibilità di sostituire il vetro è fondamentale persino su uno smartphone. L'esclusivo sistema Aluform, a differenza dei prodotti con vetri integrati al pannello e non sostituibili, permette anche ad una persona poco esperta di sostituire o installare il vetro della porta d'ingresso in tre semplici mosse.

Se si desidera installare un vetro particolare, si ha la necessità di cambiarlo perché rovinato, o semplicemente perché lo stile è troppo datato e non si adatta più ai tuoi gusti, una cosa è certa: se hai scelto Aluform il vetro lo cambi, la porta resta!

### PASSO 1

TOGLIERE LA GUARNIZIONE  
CINGIVETRO SUL LATO  
INTERNO

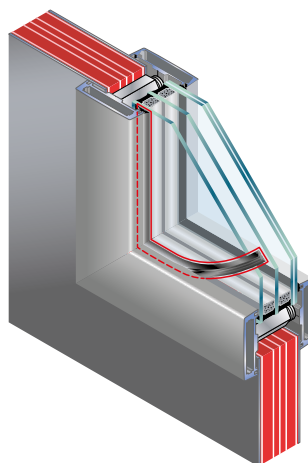

### PASSO 2

INSERIRE LA CHIAVE (\*)  
NELLO SPAZIO FRA VETRO  
E CORNICE PER SVITARE I  
SUPPORTI DI FISSAGGIO

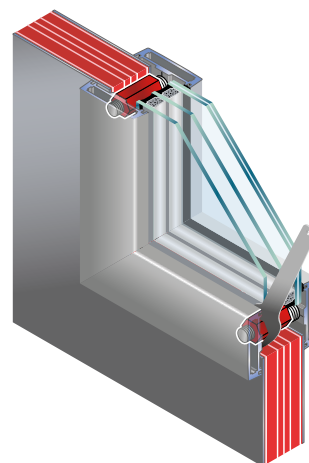

### PASSO 3

TOGLIERE LA CORNICE  
E SOSTITUIRE IL VETRO

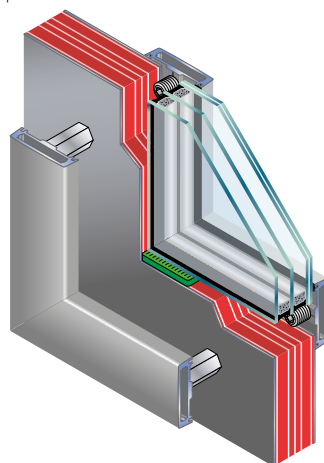

\* Chiave fornita in dotazione  
Cod. A 300

Per consentire il passaggio della chiave, lo spessore del vetro, rispetto a quello del pannello, deve essere inferiore di almeno 4 mm (8 mm per la collezione Style).

# VETRI ISOLANTI DI SICUREZZA

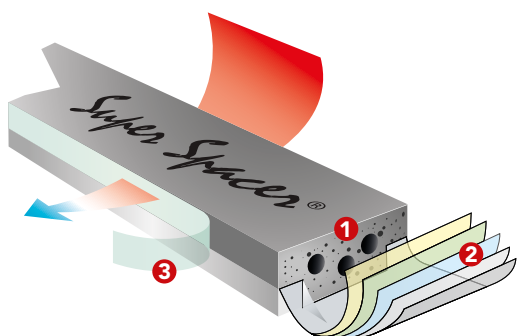

I vetri termo isolanti Aluform sono realizzati a doppio o triplo vetro di sicurezza in funzione dello spessore e delle prestazioni termiche del pannello. L'accoppiamento delle lastre di vetro avviene con distanziatori a 'bordo caldo' **Super Spacer**, una delle migliori tecnologie di ultima generazione in grado di garantire prestazioni termiche ed acustiche di elevata efficienza, per un miglior comfort abitativo ed una sensibile riduzione dei costi energetici.

**Tutti i vetri Aluform sono conformi alla norma UNI 7697 per la sicurezza.**

## TECNOLOGIA SUPER SPACER

Super Spacer è il distanziatore a 'bordo caldo' che consente di ottenere il massimo isolamento termico ed acustico nei vetri termo isolanti, perché privo di metallo.

Con l'espressione "bordo caldo" si fa riferimento alla conduttività termica del distanziatore utilizzato per separare le lastre dei vetri isolanti che ha una conduttività inferiore rispetto ai tradizionali distanziatori in metallo. Oltre a garantire una maggiore efficienza termica, quindi una sensibile riduzione dei costi energetici, Super Spacer riduce del 70% il rischio di condensa lungo il perimetro dei vetri evitando lo sviluppo di muffe dannose per la salute. Inoltre, grazie alla massa in polimero espanso a cellule chiuse, il bordo Super Spacer trasmette il suono in misura molto bassa offrendo un migliore assorbimento acustico.

### Struttura del bordo Super Spacer

- 1** - Matrice in espanso con essiccanti integrati;
- 2** - Barriera impermeabilizzante multistrato;
- 3** - Barriera sigillante adesiva su ambo i lati.

## DOPPIO VETRO PER PANNELLI SPESSORE FINO A 32 mm

## TRIPLO VETRO PER PANNELLI SPESSORE OLTRE 32 mm

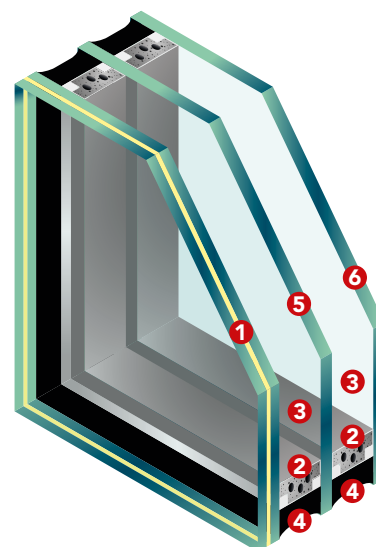
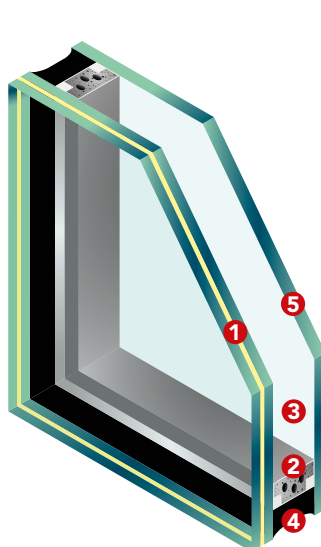

### Stratigrafia del doppio e triplo vetro

- 1** - Vetro stratificato con lamina interposta in PVB, spessore mm 6/7 o 8/9 in funzione della finitura;
- 2** - Bordo caldo tecnologia Super Spacer;
- 3** - Intercedine variabile in funzione dello spessore totale vetro;
- 4** - Seconda sigillatura in silicone strutturale;
- 5** - Vetro Temprato spessore mm 4 (finitura variabile in base alla richiesta: satinato, trasparente, decorato);
- 6** - Vetro Temprato trasparente spessore 4 mm.

**Su richiesta**, i vetri nelle finiture classiche **T** (trasparente), **A** (satinato bianco), **D** (satinato bronzo) e **Rifle** (riflettente) possono essere realizzati con tecnologia basso emissivo e gas Argon.

## FINITURE CLASSICHE

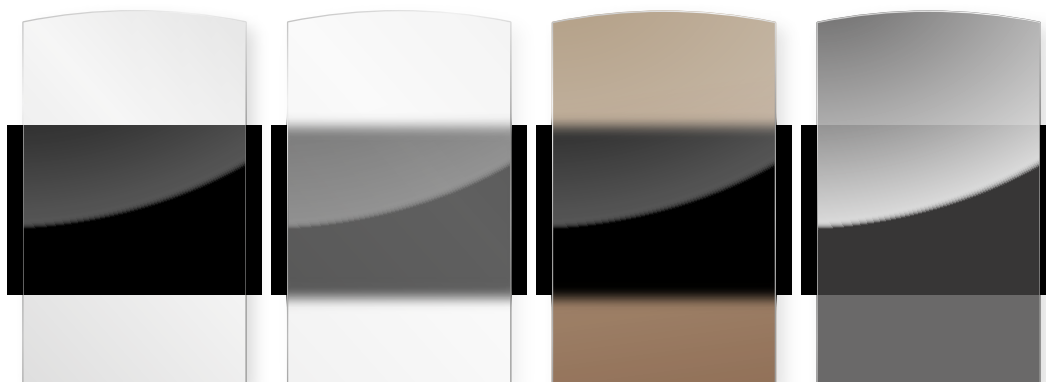

Cod. **T** (trasparente)

Cod. **A** (satinato bianco)

Cod. **D** (satinato bronzo)

Cod. **Rifle** (riflettente)  
Accoppiato al vetro  
satinato bianco (**A**) per  
garantire la privacy.

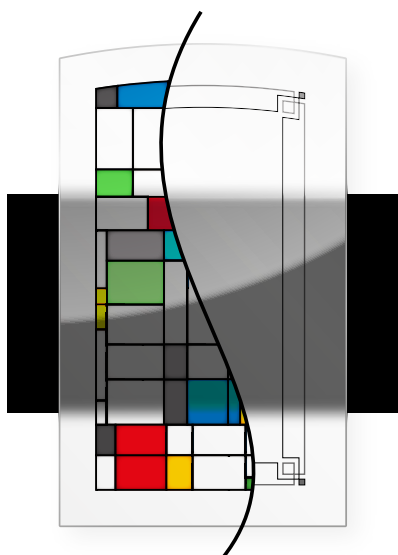

## DECORI

Ampia possibilità di personalizzazione con forme, colori e motivi unici che rendono la porta d'ingresso un vero e proprio complemento d'arredo.

Aluform adotta un'esclusiva tecnica capace di rendere traslucenti le parti opache del vetro interessate dal colore, permettendo alla luce di attraversarle in modo diffuso, ottenendo risultati di grande effetto cromatico.

Le decorazioni sono realizzate sul vetro A (satinato bianco) dal lato dell'intercapedine del doppio vetro, protetto quindi da intemperie, graffi ed ogni ulteriore rischio che possa comprometterne la durata nel tempo.

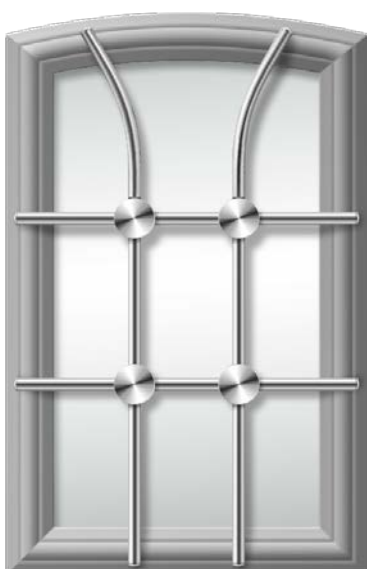

## GRATE PER VETRI

Oltre a proteggere il vetro da urti accidentali e aumentare notevolmente la resistenza contro i tentativi di intrusione, le grate di sicurezza Aluform, dal design semplice e minimale, rappresentano un elemento decorativo che distingue e valorizza la porta d'ingresso. Robuste e inattaccabili dalla ruggine, perchè realizzate in acciaio inossidabile AISI 316L, le grate di sicurezza sono un prodotto brevettato Aluform.

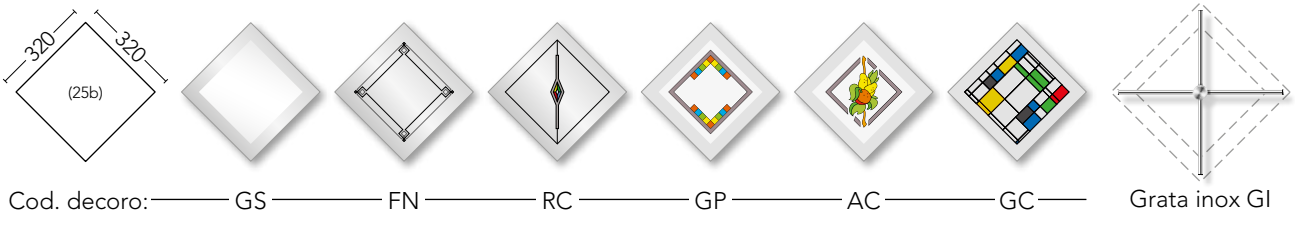
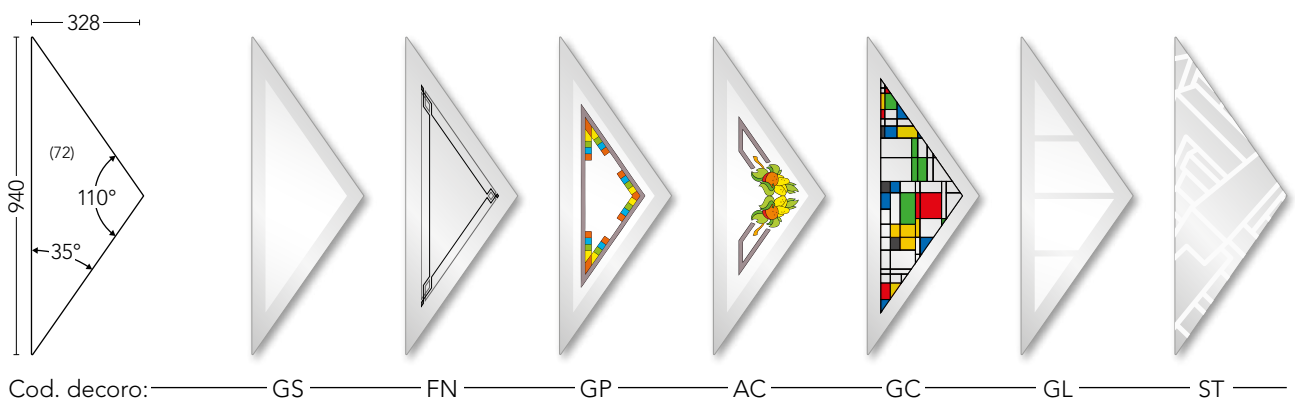
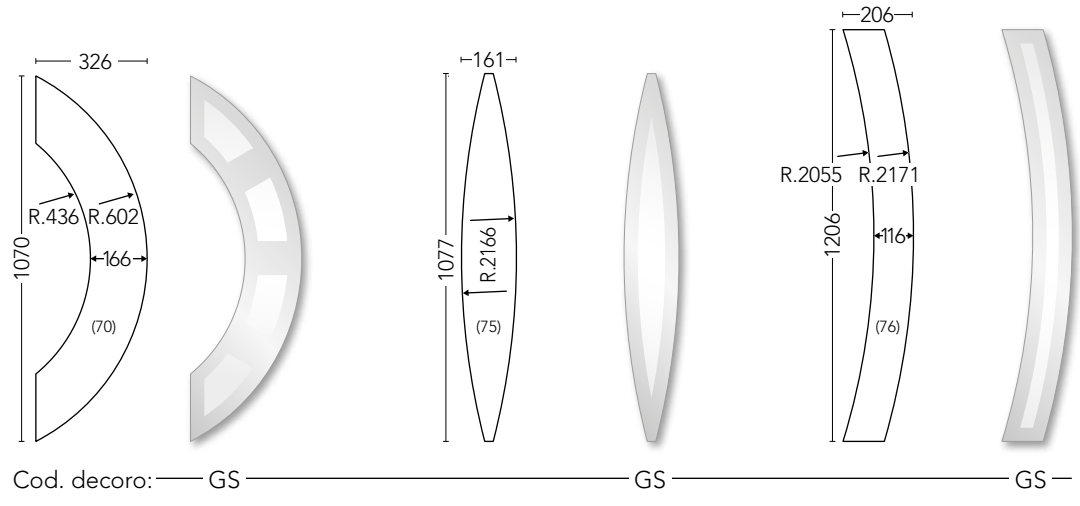
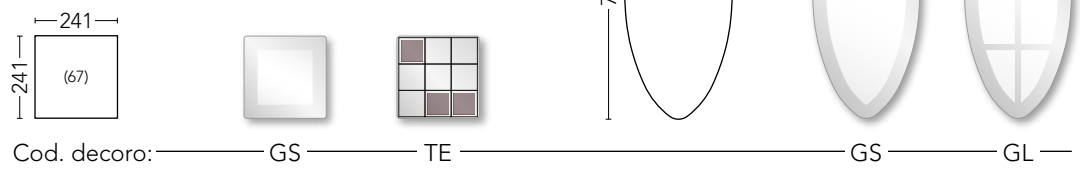
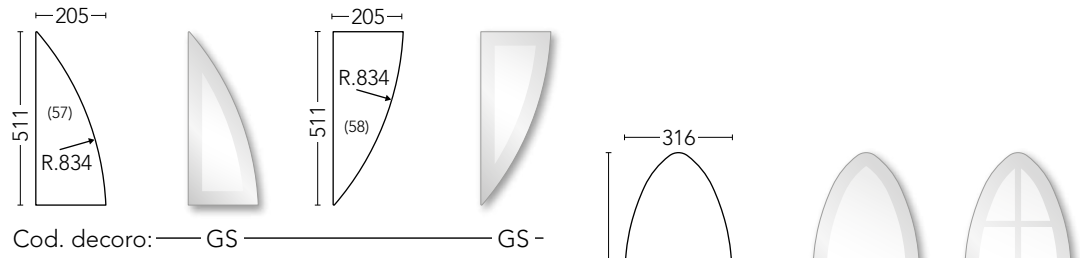
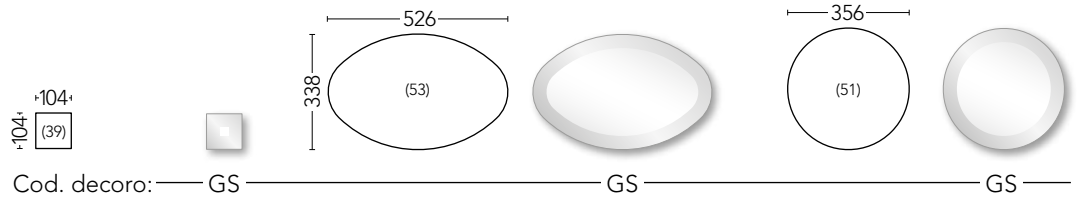

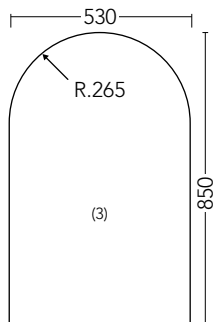

Cod. decoro: GS FN RC



GP AC GC

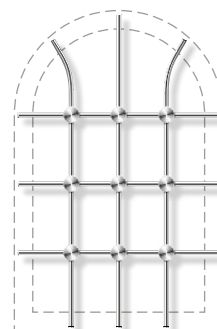

Grata inox GI

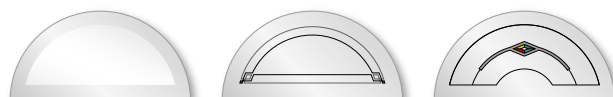
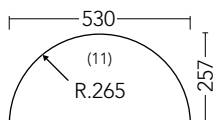

Cod. decoro: GS FN RC



GP AC GC

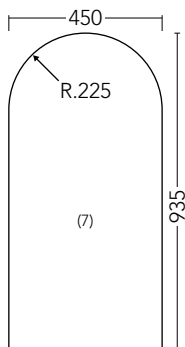

Cod. decoro: GS FN RC

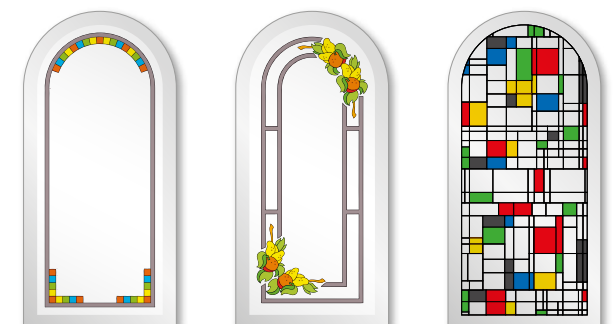

GP AC GC

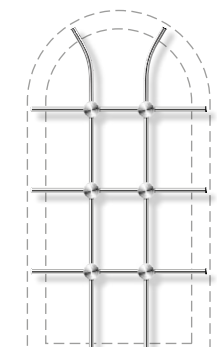

Grata inox GI

INFINITY

STYLE

A FILO

EMOTION

NOVECENTO

INCISO

**VETRI E DECORI**

MANIGLIE

PENSILINE

COLORI

SEZ. TECNICA

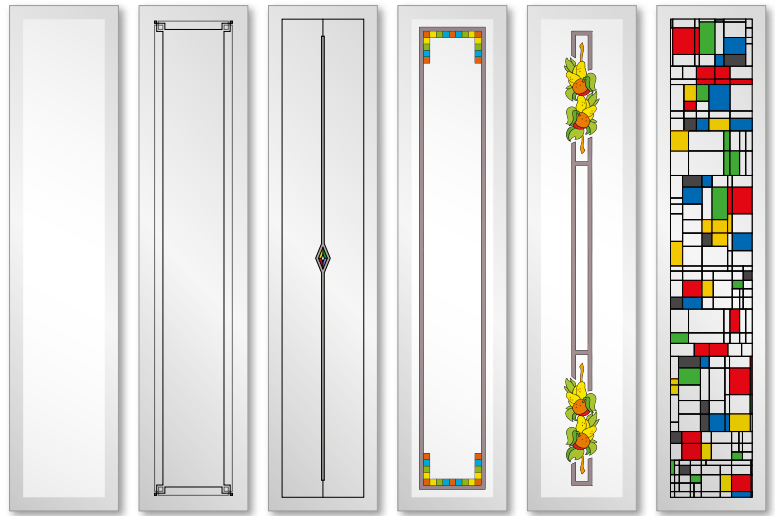
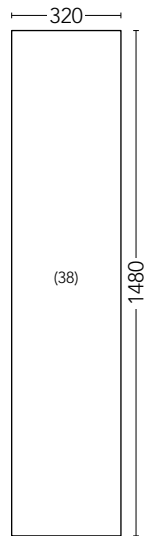
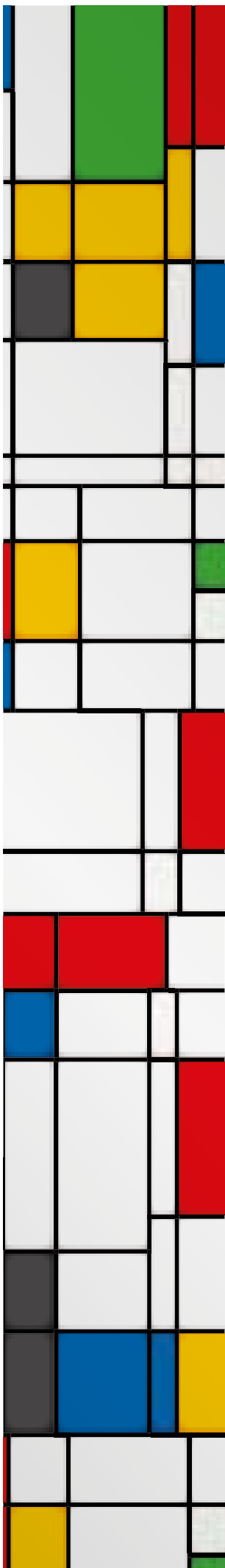

Cod. decoro: GS FN RC GP AC GC

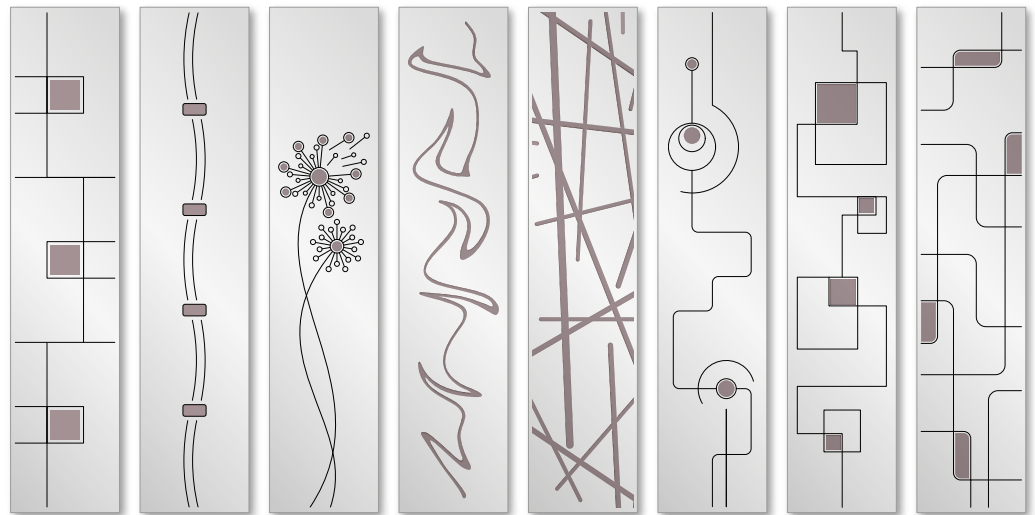

TR JO SO SM SH GE FU SP



HI GA VI EX AS CA

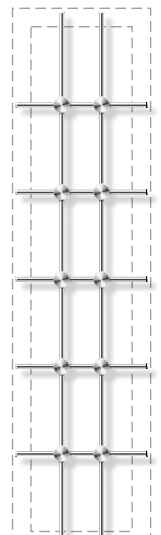

Grata inox GI



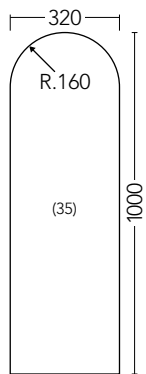

Cod. decoro: — GS — FN — RC — GP — AC — GC —

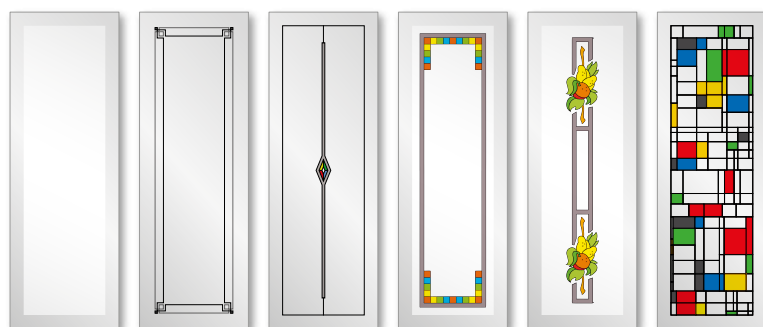
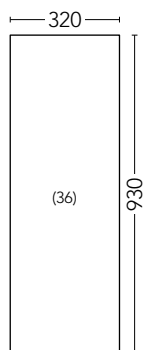

Cod. decoro: — GS — FN — RC — GP — AC — GC —

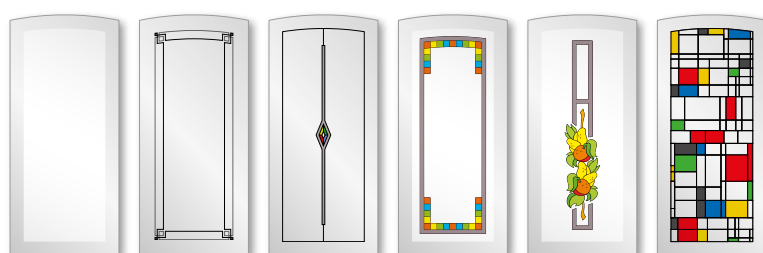
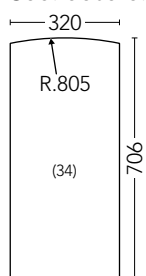

Cod. decoro: — GS — FN — RC — GP — AC — GC —

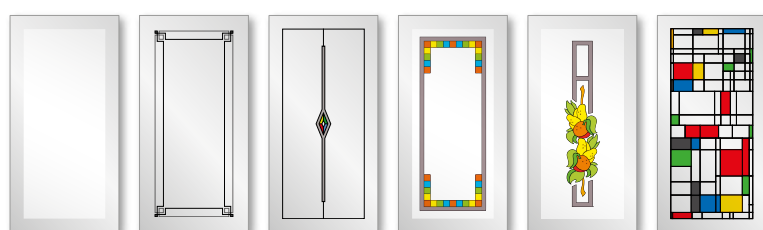
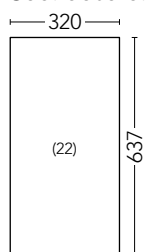

Cod. decoro: — GS — FN — RC — GP — AC — GC —

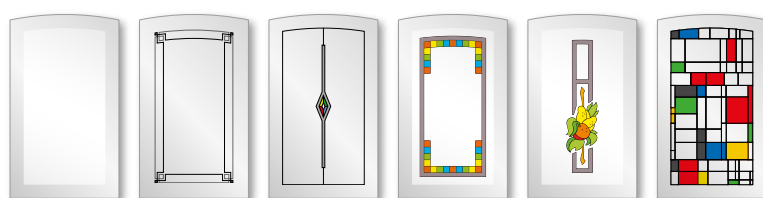
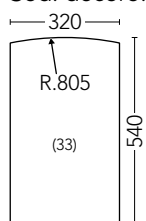

Cod. decoro: — GS — FN — RC — GP — AC — GC —

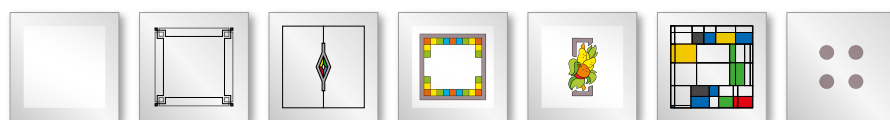
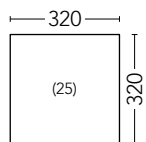

Cod. decoro: — GS — FN — RC — GP — AC — GC — BR —

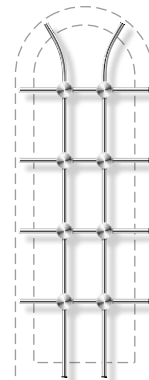

Grata inox GI

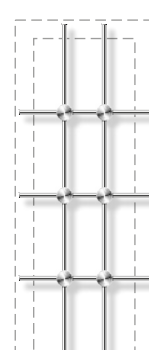

Grata inox GI

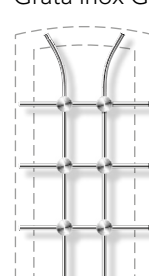

Grata inox GI

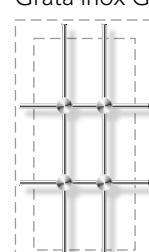

Grata inox GI

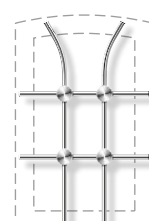

Grata inox GI

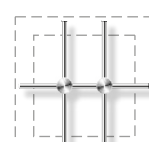

Grata inox GI

INFINITY

STYLE

A FILO

EMOTION

NOVECENTO

INCYSO

**VETRI E DECORI**

MANIGLIE

PENSILINE

COLORI

SEZ. TECNICA

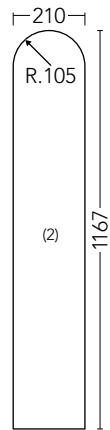

Cod. decoro: — GS — FN — RC — GP — AC — GC —

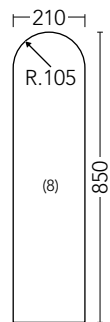
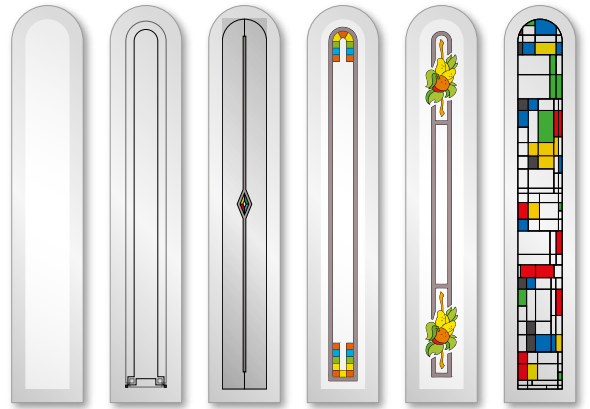

Cod. decoro: — GS — FN — RC — GP — AC — GC —

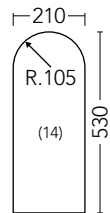
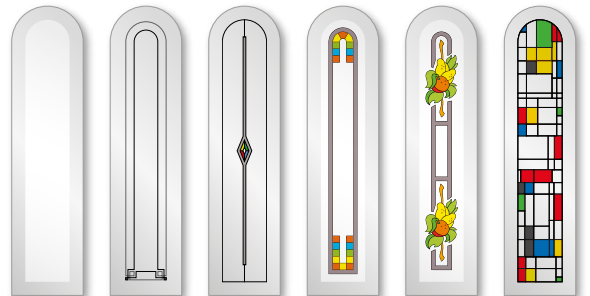

Cod. decoro: — GS — FN — RC — GP — AC — GC —

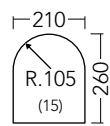

Cod. decoro: — GS — FN — RC — GP — AC — GC —

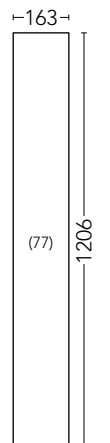

Cod. decoro: — GS — FN — RC — GP — AC — GC — BL — FL — EG — JO —

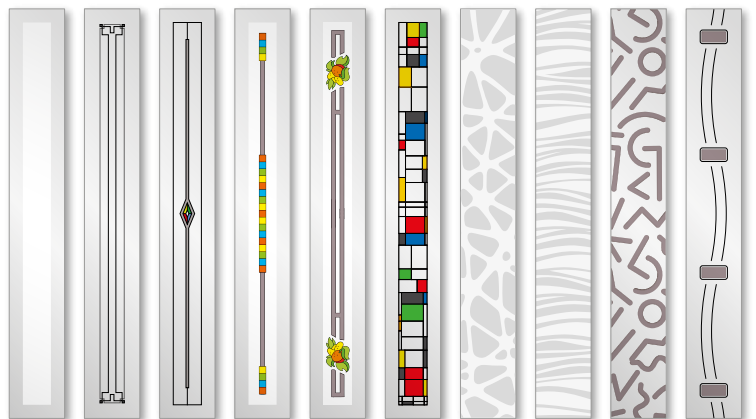

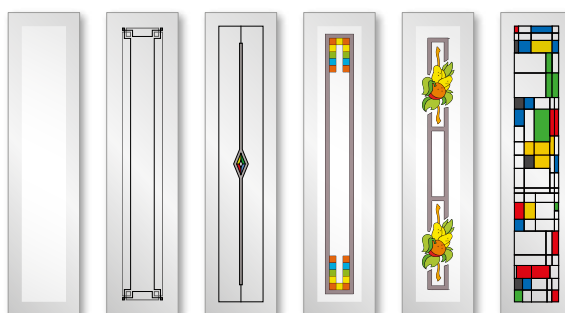
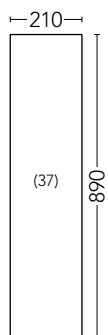

Cod. decoro: GS FN RC GP AC GC

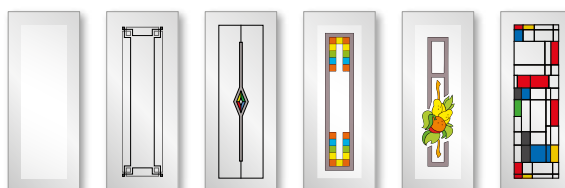
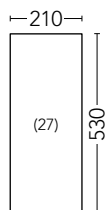

Cod. decoro: GS FN RC GP AC GC

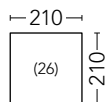

Cod. decoro: GS FN RC GP AC GC

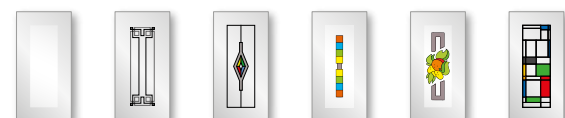
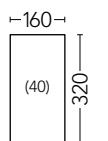

Cod. decoro: GS FN RC GP AC GC

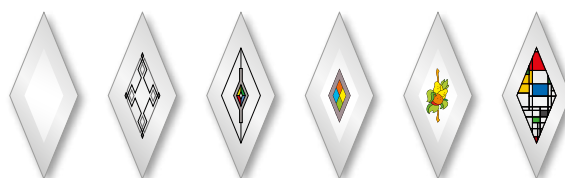
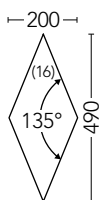

Cod. decoro: GS FN RC GP AC GC

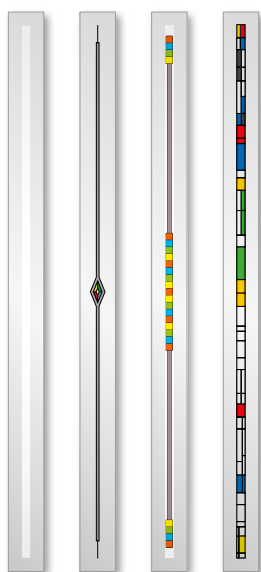
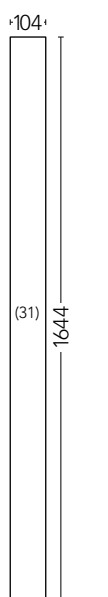

Cod. decoro: GS RC GP GC

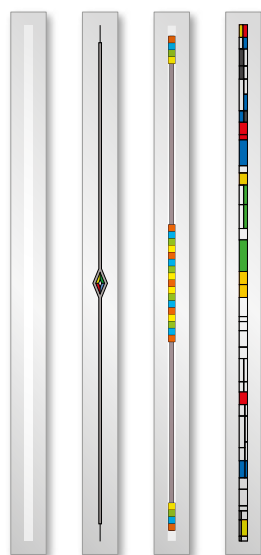

Cod. decoro: GS RC GP GC

# MANIGLIE E ACCESSORI



## Amare la perfezione anche nei dettagli!

Realizzate in Alluminio, Ottone e Acciaio Inox, personalizzabili nei colori e coordinabili con lo stile della porta, le maniglie e gli accessori Aluform sono gli elementi ideali per impreziosire il tuo ingresso con gusto e carattere.

**Anche con luce  
di cortesia a led**

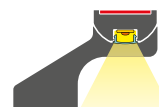
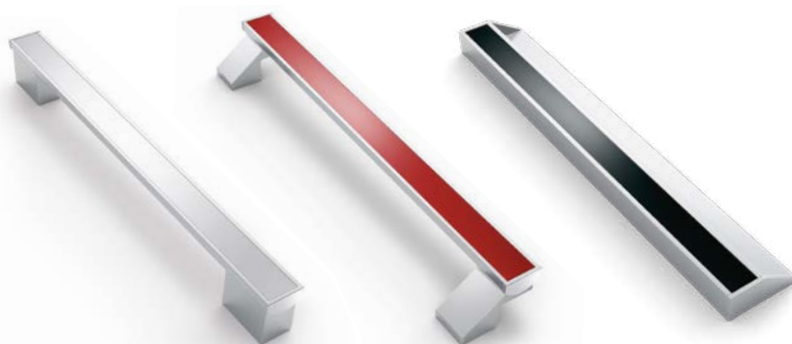
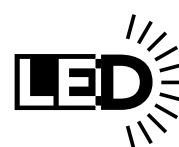

# ALLUMINIO

FINITURA EFFETTO INOX CON INSERTI IN FINITURA LACCATA GRINZ

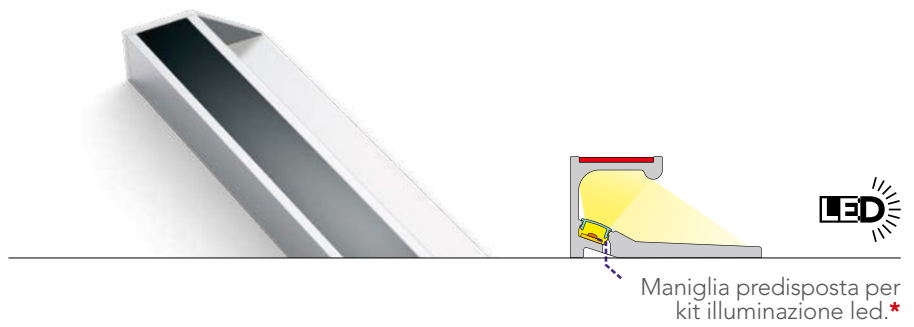
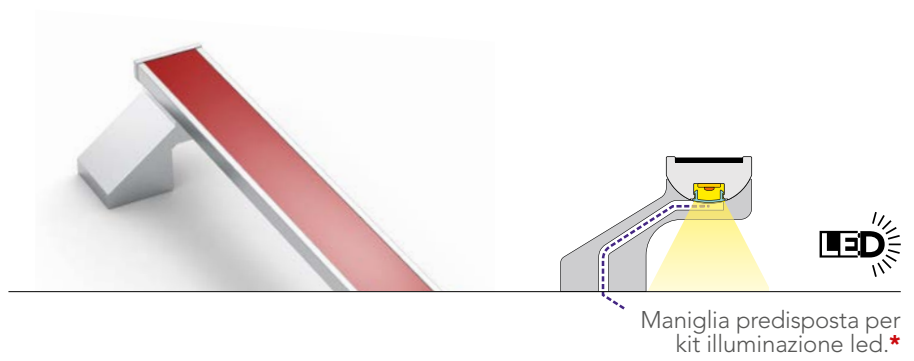
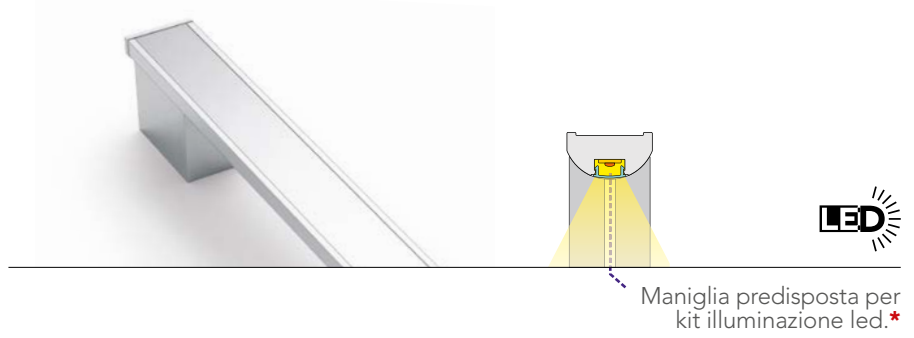

\* Il kit di illuminazione a led completo di trasformatore viene fornito su richiesta.

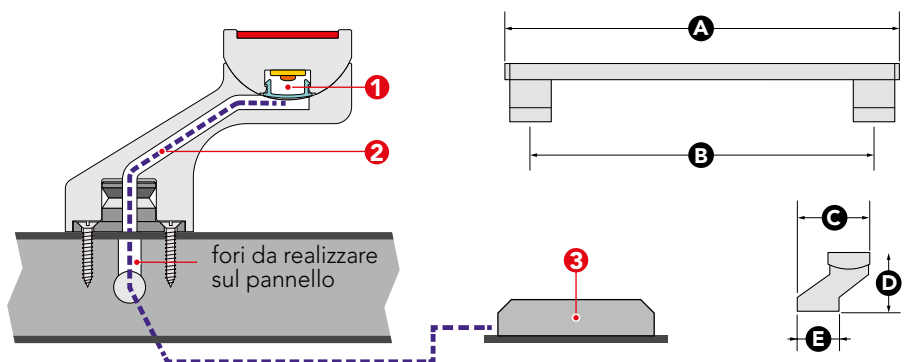

**Kit illuminazione led:** 1: Striscia Led - 2: Cavo di alimentazione - 3: Trasformatore



	Effetto inox	Ins. RAL 3003	Ins. RAL 9005	Ins. Corten RP101M	Inserto in altre finiture
Altezza (A) = 400	<b>A 951</b>	<b>A 951 R</b>	<b>A 951 N</b>	<b>A 951 C</b>	<b>A 951 X ...*</b>
Altezza (A) = 700	<b>A 952</b>	<b>A 952 R</b>	<b>A 952 N</b>	<b>A 952 C</b>	<b>A 952 X ...*</b>
Altezza (A) = 1000	<b>A 953</b>	<b>A 953 R</b>	<b>A 953 N</b>	<b>A 953 C</b>	<b>A 953 X ...*</b>
Altezza (A) = 1700	<b>A 955</b>	<b>A 955 R</b>	<b>A 955 N</b>	<b>A 955 C</b>	<b>A 955 X ...*</b>



kit illuminazione led  
**LD 040**  
**LD 070**  
**LD 100**  
**LD 170**



	Effetto inox	Ins. RAL 3003	Ins. RAL 9005	Ins. Corten RP101M	Inserto in altre finiture
Altezza (A) = 400	<b>A 961</b>	<b>A 961 R</b>	<b>A 961 N</b>	<b>A 961 C</b>	<b>A 961 X ...*</b>
Altezza (A) = 700	<b>A 962</b>	<b>A 962 R</b>	<b>A 962 N</b>	<b>A 962 C</b>	<b>A 962 X ...*</b>
Altezza (A) = 1000	<b>A 963</b>	<b>A 963 R</b>	<b>A 963 N</b>	<b>A 963 C</b>	<b>A 963 X ...*</b>



kit illuminazione led  
**LD 040**  
**LD 070**  
**LD 100**

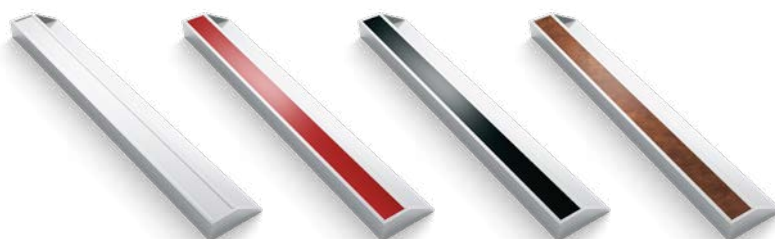

	Effetto inox	Ins. RAL 3003	Ins. RAL 9005	Ins. Corten RP101M	Inserto in altre finiture
Altezza (A) = 400	<b>A 971</b>	<b>A 971 R</b>	<b>A 971 N</b>	<b>A 971 C</b>	<b>A 971 X ...*</b>
Altezza (A) = 700	<b>A 972</b>	<b>A 972 R</b>	<b>A 972 N</b>	<b>A 972 C</b>	<b>A 972 X ...*</b>
Altezza (A) = 1000	<b>A 973</b>	<b>A 973 R</b>	<b>A 973 N</b>	<b>A 973 C</b>	<b>A 973 X ...*</b>



kit illuminazione led  
**LD 040**  
**LD 070**  
**LD 100**

\* Indicare il codice della finitura dopo la X. Disponibili solo nei colori della serie LAC finitura Grinz e EXCLUSIVE

ARTICOLI	MISURE millimetri					FISSAGGI forniti di serie
	A	B	C	D	E	
<b>A 951</b>	400	354	38	60	36	<b>PS - PD - NP</b>
<b>A 952</b>	700	654	38	60	36	<b>PS - PD - NP</b>
<b>A 953</b>	1000	954	38	60	36	<b>PS - PD - NP</b>
<b>A 955</b>	1700	1654	38	60	36	<b>PS - PD - NP</b>
<b>A 961</b>	400	354	85	60	38	<b>PS - PD - NP</b>
<b>A 962</b>	700	654	85	60	38	<b>PS - PD - NP</b>
<b>A 963</b>	1000	954	85	60	38	<b>PS - PD - NP</b>
<b>A 971</b>	400	-	85	42	85	<b>NP</b>
<b>A 972</b>	700	-	85	42	85	<b>NP</b>
<b>A 973</b>	1000	-	85	42	85	<b>NP</b>

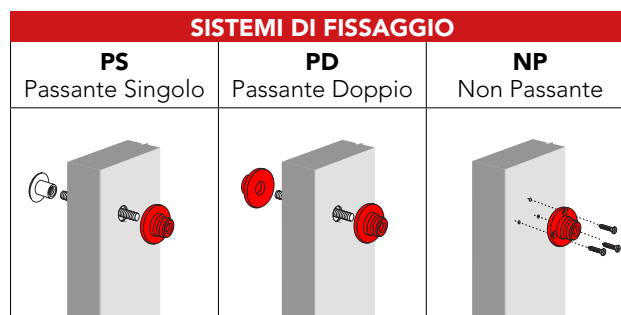

# ALLUMINIO

FINITURA EFFETTO INOX E LACCATI IN FINITURA GRINZ

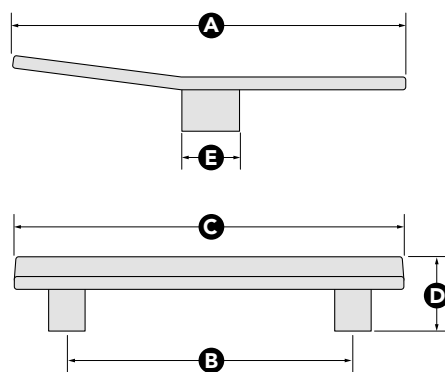
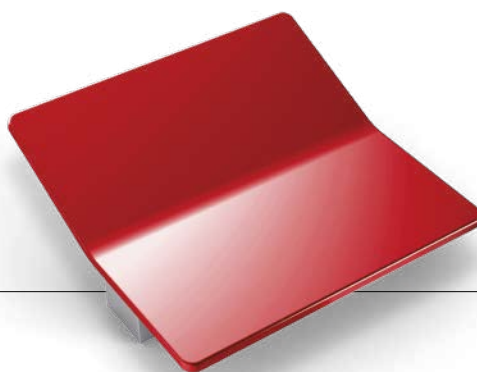



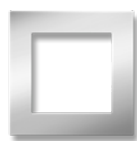

Effetto inox  
**A 941**



RAL 3003  
**A 941 R**



RAL 9005  
**A 941 N**

Altre finiture  
**A 941 X ...\***



Effetto inox  
**A 942**



RAL 3003  
**A 942 R**



RAL 9005  
**A 942 N**

Altre finiture  
**A 942 X ...\***



Effetto inox  
**A 943**



RAL 3003  
**A 943 R**



RAL 9005  
**A 943 N**

Altre finiture  
**A 943 X ...\***

\* Indicare il codice della finitura dopo la X. Disponibili solo nei colori della serie LAC finitura Grinz e EXCLUSIVE

ARTICOLI	MISURE millimetri					FISSAGGI forniti di serie
	A	B	C	D	E	
<b>A 941</b>	280	230	280	50	50	<b>PS - PD - NP</b>
<b>A 942</b>	273	230	280	100	50	<b>PS - PD - NP</b>
<b>A 943</b>	321	230	330	100	38	<b>PS - PD - NP</b>

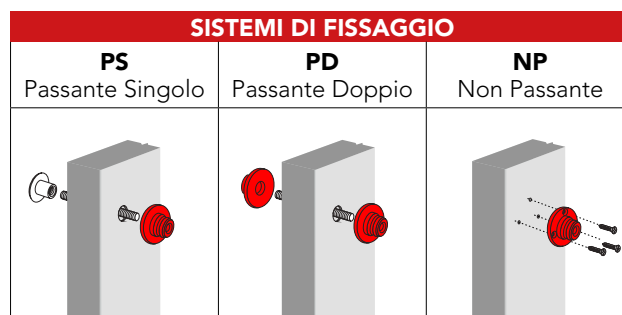

# ALLUMINIO

FINITURA EFFETTO INOX E LACCATI IN FINITURA GRINZ



Effetto inox

**A 944**



RAL 3003

**A 944 R**



RAL 9005

**A 944 N**

Altre finiture **A 944 X ...\***



Effetto inox

**A 945**



RAL 3003

**A 945 R**



RAL 9005

**A 945 N**

Altre finiture **A 945 X ...\***



Effetto inox

**A 946**



RAL 3003

**A 946 R**



RAL 9005

**A 946 N**

Altre finiture **A 946 X ...\***

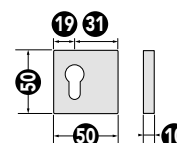
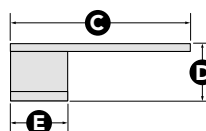
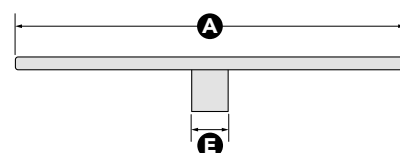
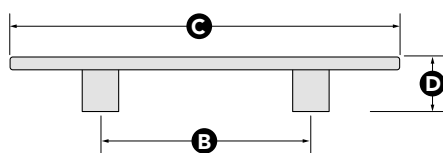



**A 902**  
Maniglia destra completa di  
bocchetta per cilindro europeo,  
finitura alluminio OX argento



inserto RAL 3003

**A 902 R**



inserto RAL 9005

**A 902 N**



inserto Corten RP101M

**A 902 C**

Inserto in  
altre finiture

**A 902 X ...\***

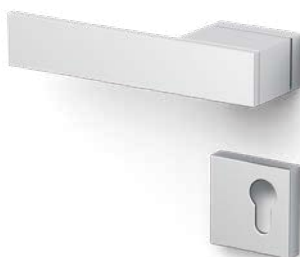

**A 903**  
Maniglia sinistra completa di  
bocchetta per cilindro europeo,  
finitura alluminio OX argento



inserto RAL 3003

**A 903 R**



inserto RAL 9005

**A 903 N**



inserto Corten RP101M

**A 903 C**

Inserto in  
altre finiture

**A 903 X ...\***

\* Indicare il codice della finitura dopo la X. Disponibili solo nei colori della serie LAC finitura Grinz e EXCLUSIVE

ARTICOLI	MISURE millimetri					FISSAGGI forniti di serie
	A	B	C	D	E	
<b>A 902-A 903</b>	-	-	155	47	50	-
<b>A 944</b>	160	130	255	55	38	<b>PS - PD - NP</b>
<b>A 945</b>	120	-	120	57	38	<b>PS - PD - NP</b>
<b>A 946</b>	160	-	160	57	38	<b>PS - PD - NP</b>

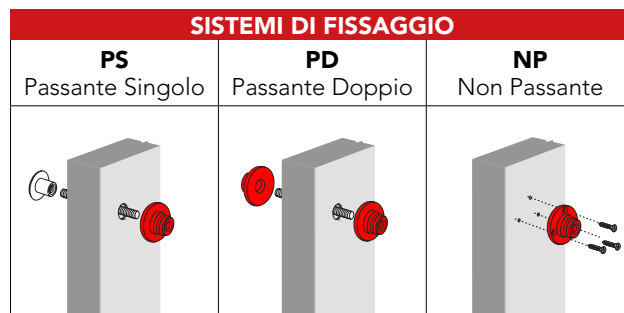

# ACCIAIO INOX

AISI 316L



A 680

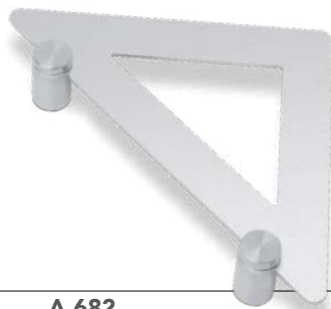

A 682

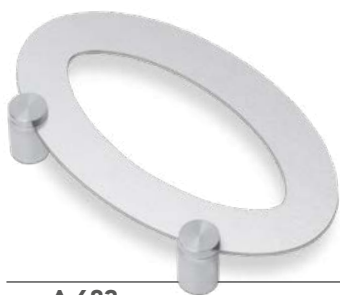

A 683



A 685

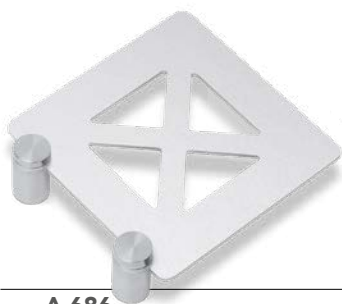

A 686



A 687

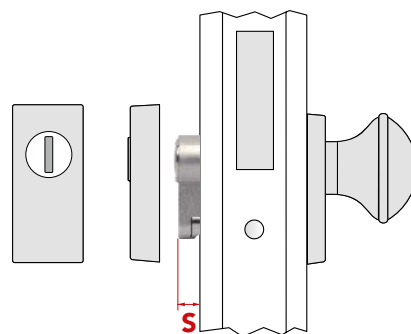
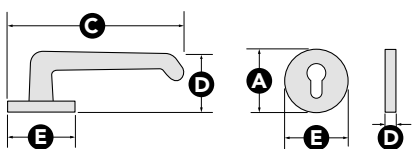
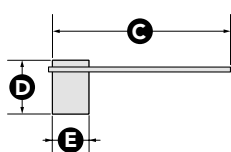
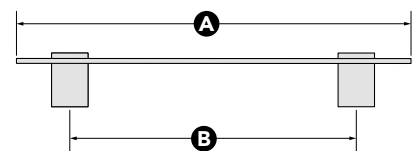

Per installare il Defender, sporgenza del cilindro (S) min. 7, max 10 mm.

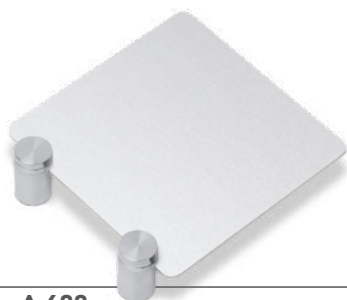

A 688



A 689



A 691



A 692



A 693



A 601



A 673



A 676



A 679



A 672



A 674

ARTICOLI	MISURE millimetri					FISSAGGI forniti di serie
	A	B	C	D	E	
A 601	-	-	150	70	50	-
A 672 - A 674	70	-	-	15	30	-
A 673	50	-	-	9	50	-
A 676	67	-	-	4	27	-
A 679	62	-	-	4	25	-
A 680	420	250	157	52	32	PS - PD - NP*
A 682 - A 692	372	250	212	52	32	PS - PD - NP*
A 683	300	185	174	52	32	PS - PD - NP*
A 685 - A 689	200	125	194	52	32	PS - PD - NP*
A 686 - A 687 - A 688	200	125	217	52	32	PS - PD - NP*
A 691	420	250	117	52	32	PS - PD - NP*
A 693	470	250	162	52	32	PS - PD - NP*

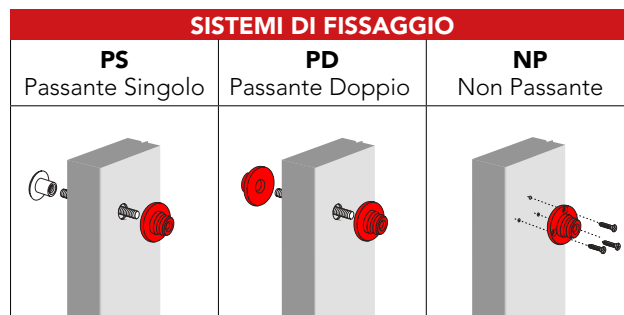

\* Fissaggi non passanti su richiesta, Art. **ATR732**



# ACCIAIO INOX

AISI 316L



A 613



A 616



A 618

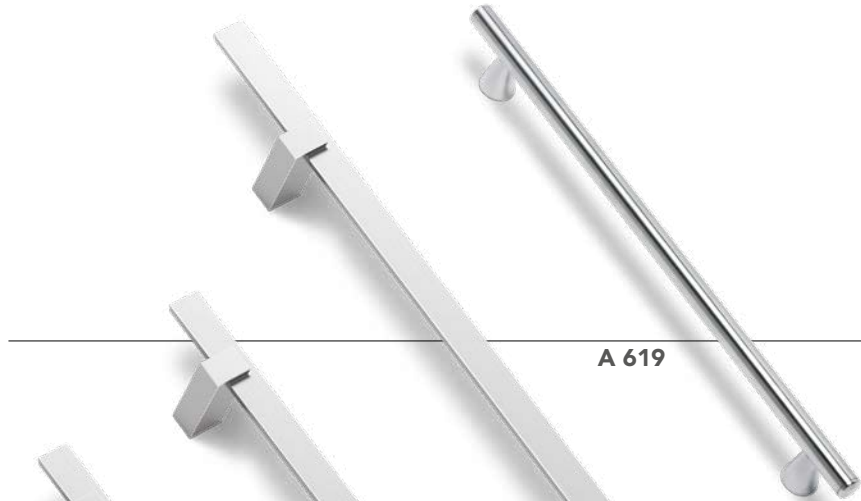

A 619

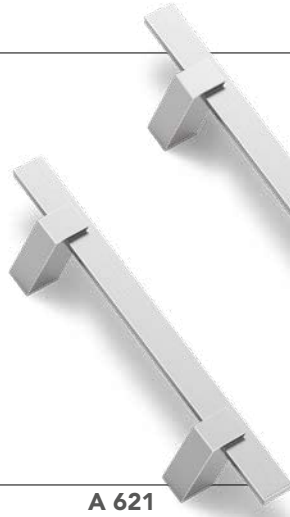

A 621

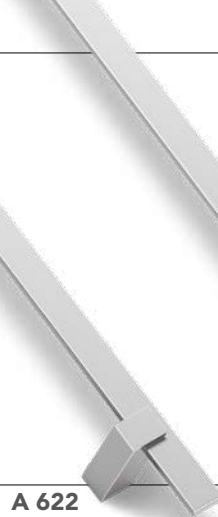

A 622



A 623

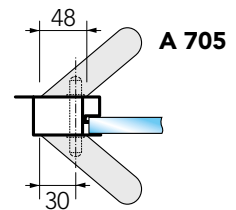
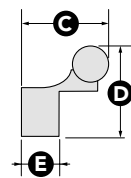
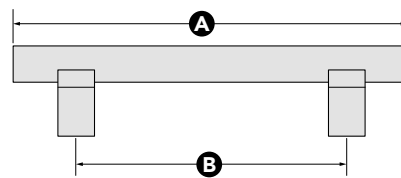

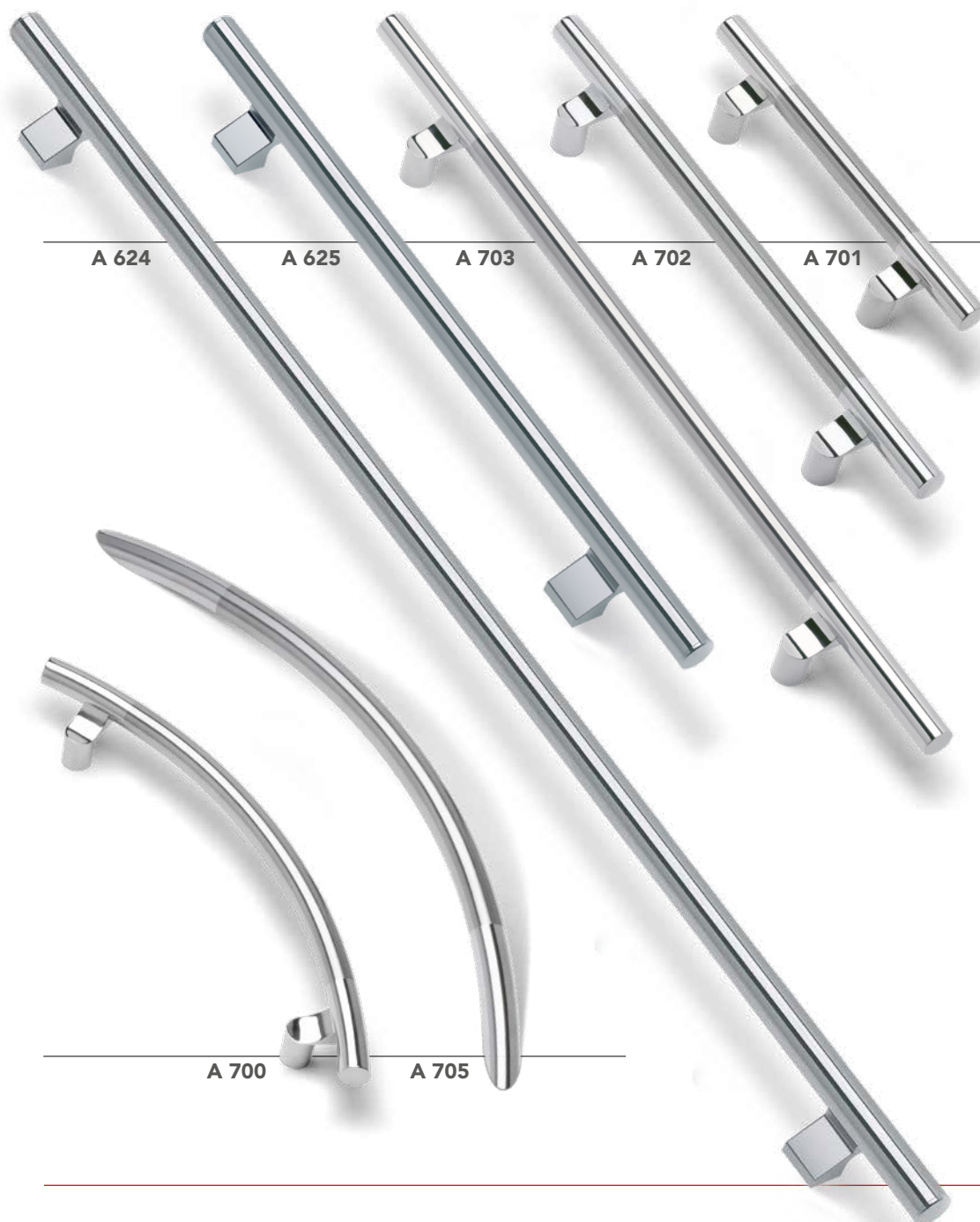

ARTICOLI	MISURE millimetri					FISSAGGI forniti di serie
	A	B	C	D	E	
<b>A 613</b>	333	230	95	85	35	<b>PS - PD - NP<sup>(1)</sup></b>
<b>A 616</b>	306	230	90	80	35	<b>PS - PD - NP<sup>(1)</sup></b>
<b>A 618</b>	387	230	126	84	35	<b>PS - PD - NP<sup>(1)</sup></b>
<b>A 619</b>	560	460	32	57	32	<b>PS - PD - NP<sup>(2)</sup></b>
<b>A 621</b>	400	250	74	57	35	<b>PS - PD - NP</b>
<b>A 622</b>	600	425	74	57	35	<b>PS - PD - NP</b>
<b>A 623</b>	1000	700	74	57	35	<b>PS - PD - NP</b>
<b>A 624</b>	1700	1450	86	78	38	<b>PS - PD - NP</b>
<b>A 625</b>	900	700	86	78	38	<b>PS - PD - NP</b>
<b>A 700</b>	610	430	120	75	32	<b>PS - PD - NP<sup>(2)</sup></b>
<b>A 701</b>	400	250	76	75	32	<b>PS - PD - NP<sup>(2)</sup></b>
<b>A 702</b>	600	425	76	75	32	<b>PS - PD - NP<sup>(2)</sup></b>
<b>A 703</b>	1000	700	76	75	32	<b>PS - PD - NP<sup>(2)</sup></b>
<b>A 705</b>	700	600	105	83	48	<b>PS - PD</b>

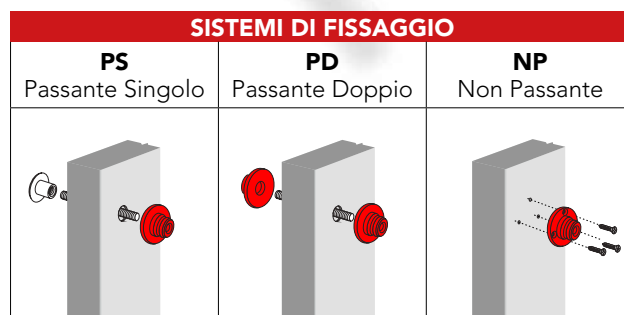

- 1:** Fissaggi non passanti su richiesta, Art. **ATR6**  
**2:** Fissaggi non passanti su richiesta, Art. **ATR732**

# OTTONE

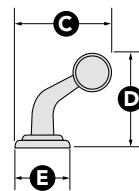
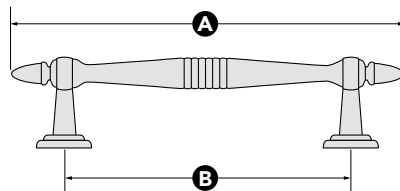
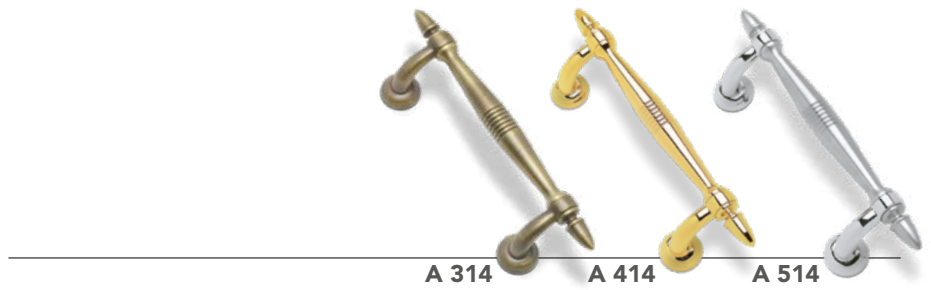
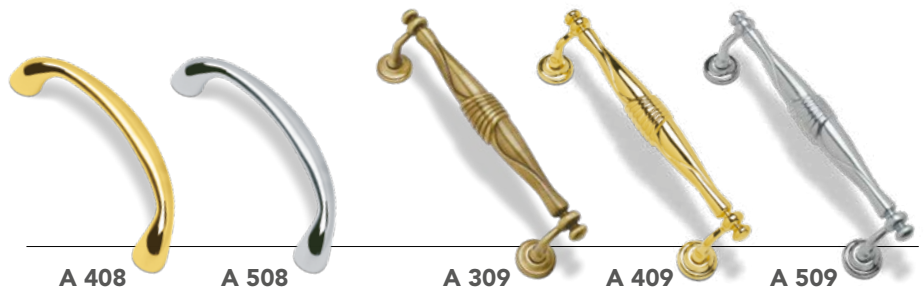
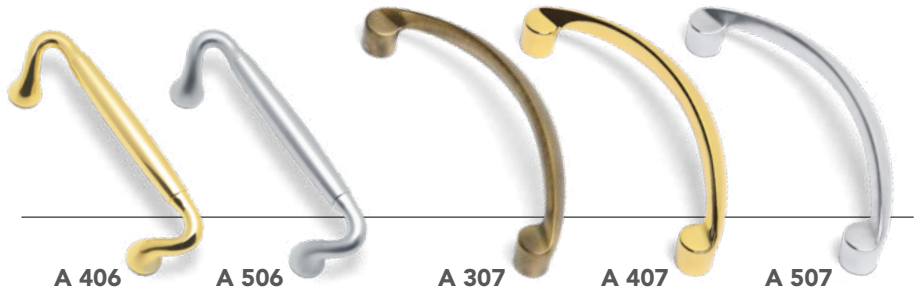



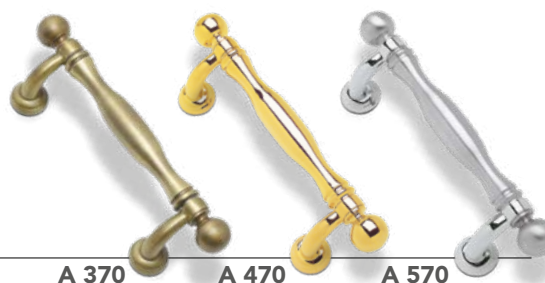
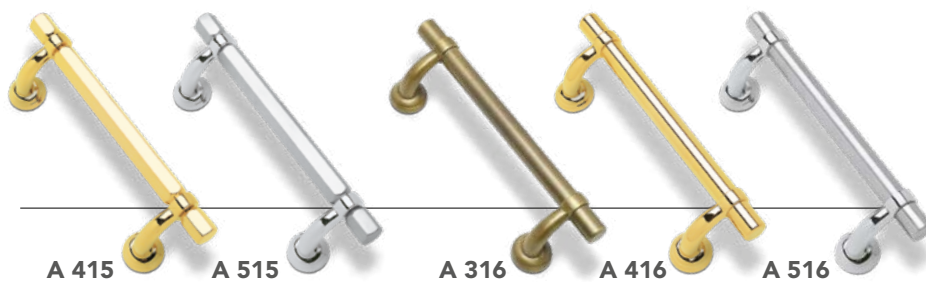

ARTICOLI	MISURE millimetri					FISSAGGI forniti di serie
	A	B	C	D	E	
A 406-A 506	295	230	80	75	37	PS - PD* - NP
A 307-A 407-A 507	316	283	95	75	33	PS - PD* - NP
A 408-A 508	266	233	60	57	33	PS - PD* - NP
A 309-A 409-A 509	320	280	80	88	45	PS - PD* - NP
A 314-A 414-A 514	336	230	90	68	44	PS - PD* - NP
A 415-A 515	315	235	90	68	44	PS - PD* - NP
A 316-A 416-A 516	307	230	90	68	44	PS - PD* - NP
A 417-A 517	309	230	90	68	44	PS - PD* - NP
A 318-A 418-A 518	313	280	65	65	33	PS - PD* - NP
A 370-A 470-A 570	340	235	94	73	44	PS - PD* - NP



\* Fissaggi passanti doppi su richiesta, Art. **ATPD1**

# OTTONE



A 330



A 430



A 530



A 331



A 431



A 531



A 334



A 434



A 534

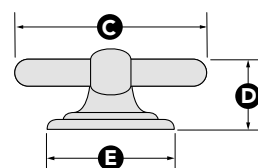
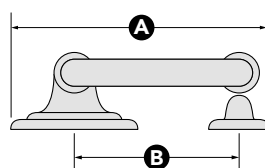
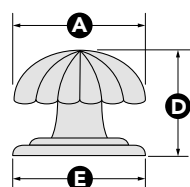



A 340



A 440



A 520



A 320



A 420



A 540



A 322



A 422



A 522



A 325



A 425



A 525

ARTICOLI	MISURE millimetri					FISSAGGI forniti di serie
	A	B	C	D	E	
A 320 - A 420 - A 540	155	100	118	60	79	NP
A 322 - A 422 - A 522	144	103	125	60	50	NP
A 325 - A 425 - A 525	163	107	110	63	79	NP
A 330 - A 430 - A 530	80	-	-	83	80	NP
A 331 - A 431 - A 531	82	-	-	73	80	NP
A 334 - A 434 - A 534	60	-	-	57	45	NP
A 340 - A 440 - A 520	165	110	135	58	79	NP



# OTTONE



A 379



A 479



A 579



A 374



A 474



A 574



A 380



A 480



A 580



A 376



A 476



A 576



A 373



A 473



A 573



A 345



A 40



A 545

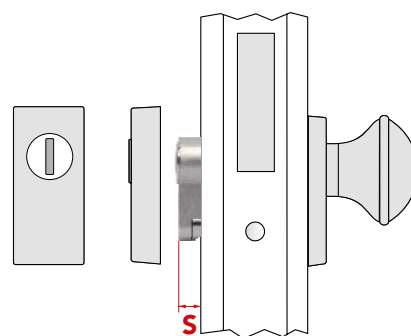
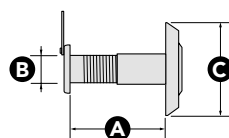
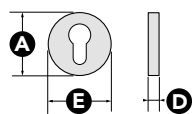
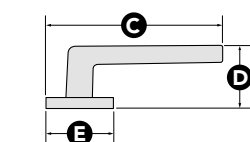

Per installare il Defender, sporgenza del cilindro (S) min. 7, max 10 mm.



**A 365**

**A 465**

**A 565**



**A 355**

**A 55**

**A 550**



**A 368**

**A 468**

**A 568**



**A 332**

**A 432**

**A 532**

Pomi girevoli ambidestri

ARTICOLI	MISURE millimetri				
	A	B	C	D	E
<b>A 332 - A 432 - A 532</b>	-	-	60	75	50
<b>A 345 - A 40 - A 545</b>	18/45	14	27	-	-
<b>A 355 - A 55 - A 550</b>	-	-	104	60	50
<b>A 365 - A 465 - A 565</b>	-	-	150	66	50
<b>A 368 - A 468 - A 568</b>	-	-	95	60	31
<b>A 373 - A 473 - A 573</b>	50	-	-	10	50
<b>A 374 - A 474 - A 574</b>	70	-	-	15	30
<b>A 376 - A 476 - A 576</b>	70	-	-	15	30
<b>A 379 - A 479 - A 579</b>	61	-	-	10	31
<b>A 380 - A 480 - A 580</b>	61	-	-	10	31

Gli articoli:  
A 40, A 55, A 432, A 465 non hanno il trattamento PVD.

INFINITY

STYLE

A FILO

EMOTION

NOVECENTO

INCYSO

VETRI E DECORI

**MANIGLIE**

PENSILINE

COLORI

SEZ. TECNICA

## ALUFORM DSP

DESMODROMIC SYSTEM POWER

Il cilindro è il cuore della sicurezza di ogni serratura. Rendi più sicura la tua porta con il cilindro Aluform DSP.



- ✓ ANTITRAPANO
- ✓ ANTISTRAPPO
- ✓ ANTIBUMPING
- ✓ CERTIFICATO

I cilindri **Aluform DSP** sono certificati secondo la normativa europea UNI EN 1303 con la **classificazione 16000C62**. Il massimo grado di durata e sicurezza.



### DEFENDER

Con l'utilizzo del defender, maggiore protezione agli attacchi di scasso e tentativi di manomissione.

## CILINDRI DI SICUREZZA

ALUFORM DSP

### Concetto "desmodromico"

Il meccanismo del cilindro Aluform ADSP è basato sul concetto di percorso obbligato. In assenza della chiave le gole di combinazione si dispongono in posizione «random», ogni movimento o vibrazione impressa al cilindro provoca lo spostamento delle gole in maniera non prevedibile.

All'inserimento della chiave nel cilindro, le gole assumono la posizione corrispondente alla pista ricavata sulla chiave, quindi alla sua codifica.

Grazie al sistema di cifratura desmodromica, al cilindro **Aluform DSP** non è applicabile la diffusa tecnica di apertura illegale dei cilindri denominata "bumping".

### 235.920 differenti combinazioni

La normativa UNI EN 1303, come possibili diverse combinazioni delle chiavi, stabilisce da un minimo di 100 combinazioni (grado 1) ad un massimo di almeno 100.000 (grado 6). Le combinazioni effettive del cilindro Aluform DSP sono addirittura 235.920. Oltre il doppio delle diverse possibilità di combinazioni richieste dalla norma per il massimo grado di sicurezza.

### Protezione antitrapano

La protezione antitrapano è garantita da una sfera e una spina, in acciaio temprato inserite nel cilindro.

### Resistenza all'effrazione

Il cilindro Aluform DSP è dotato di una barra di collegamento dei moduli in lega di acciaio che garantisce una resistenza elevata in caso di forzatura del cilindro.

### Controllo profilo chiave

Una piastra a forma di mezzaluna protegge le gole di combinazione, svolgendo anche la funzione di controllo del profilo della chiave.

### PRATICA CHIAVE A SCATTO

TASCABILE E REVERSIBILE

Il cilindro **Aluform DSP** viene fornito di serie con 3 comode chiavi ad apertura a scatto tascabili. Inoltre, i due lati della chiave sono ugualmente operativi, non occorre quindi trovare l'orientamento giusto della chiave prima di inserirla nel cilindro.



### RIPRODUZIONE DELLE CHIAVI

PROTETTA DALLA CARTA DI PROPRIETÀ

La carta di proprietà viene consegnata nelle mani del proprietario della abitazione in busta sigillata. Essa riporta i numeri impressi sul gambo delle chiavi e costituisce l'unico mezzo per comprovare la legittima richiesta di duplicati che possono essere effettuati solo esibendo la carta presso i rivenditori **Aluform**.



**CILINDRO**  
CHIAVE-CHIAVE



Soluzione adatta alle porte a doppio passaggio. La chiave inserita da un lato, esclude l'ingresso della chiave sul lato opposto.

**La fornitura comprende:**

- un cilindro chiave/chiave e vite di fissaggio
- tre chiavi a scatto reversibili
- scheda anti duplicazione chiavi in busta sigillata
- istruzioni d'uso e montaggio



**CILINDRO**  
CHIAVE-POMO



Soluzione ideale per porte d'ingresso. Il pomo lato abitazione permette di chiudere la serratura dall'interno senza l'utilizzo della chiave, ciò evita il rischio di dimenticare la chiave inserita dal lato interno.

**La fornitura comprende:**

- un cilindro chiave/pomo e vite di fissaggio
- tre chiavi a scatto reversibili
- un pomo con adattatore per bocchette a profilo europeo
- scheda anti duplicazione chiavi in busta sigillata
- istruzioni d'uso e montaggio



Cilindro **Chiave-Chiave**

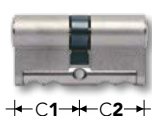

Cilindro **Chiave-Pomo**

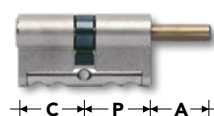

Art.	C1-C2 mm	Art.	C1-C2 mm
A.CC 30.30	30-30	A.CC 35.40	35-40
A.CC 30.35	30-35	A.CC 40.45	40-45
A.CC 30.40	30-40	A.CC 40.50	40-50
A.CC 30.45	30-45	A.CC 40.55	40-55
A.CC 30.50	30-50	A.CC 40.60	40-60
A.CC 30.55	30-55	A.CC 45.45	45-45
A.CC 30.60	30-60	A.CC 45.55	45-55
A.CC 30.65	30-65	A.CC 45.65	45-65
A.CC 35.35	35-35		

Art.	C-P-A mm
A.CP 30.30	30-30-49
A.CP 40.30	40-30-75
A.CP 45.30	45-30-49
A.CP 50.30	50-30-75
A.CP 55.30	55-30-41
A.CP 60.30	60-30-75

**CHIAVE AGGIUNTIVA**



**Art. A.CH100**



## NUMERI CIVICI

IN ACCIAIO INOX AISI 316L

**Anche i dettagli richiedono grandi idee.**

Aluform ha creato il numero civico componibile dal design elegante ed essenziale, realizzato con placca in Plexiglass satinato spesso 8 mm e supporti in acciaio inox. La placca è preforata e pronta per fissare numeri o lettere da ordinare separatamente.



NC651



NC652



NC653



NC654

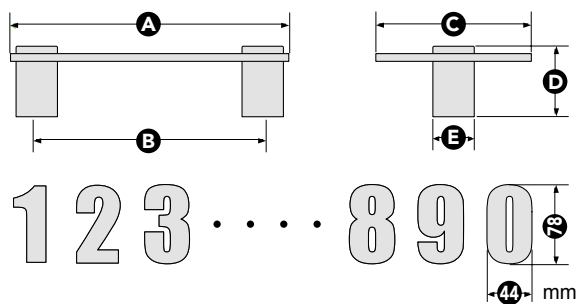





NC601    NC602    NC603    NC604    NC605    NC606    NC607



NC608    NC609    NC600    NC600A    NC600B    NC600C    NC600D

ARTICOLI	MISURE millimetri					ATTACCO
	A	B	C	D	E	
NC651	190	155	120	54	32	Tassello da 8 mm
NC652	215	180	120	54	32	Tassello da 8 mm
NC653	265	230	130	54	32	Tassello da 8 mm
NC654	315	280	140	54	32	Tassello da 8 mm

**SISTEMI DI FISSAGGIO**

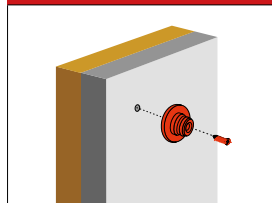

# NEWENTRY

## PENSILINE by ALUFORM

### Eleganti e accoglienti!

Il sistema di copertura ideale per proteggere l'ingresso ed ovunque ci sia bisogno di un riparo da pioggia, grandine e neve.

La soluzione versatile e sicura caratterizzata dalla semplicità di montaggio, disponibile in diversi stili che si abbinano ad ogni tipo di architettura. Un segno di benvenuto leggero, ricercato, esteticamente impeccabile!



## Facili, sicure, versatili



### **FACILI DA INSTALLARE**

Sono fornite in Kit, complete di tutta la viteria e le istruzioni per il montaggio. Un sistema brevettato che permette di assemblare la pensilina pezzo dopo pezzo, direttamente sulla parete, senza richiedere particolari impalcature o impegnativi mezzi di sollevamento.

### **SISTEMA MODULARE**

Unendo più moduli è possibile ottenere qualsiasi larghezza. Inoltre, con i moduli ad angolo, è possibile seguire l'andamento della parete ed ottenere la continuità del riparo ovunque.

### **CURATE IN OGNI DETTAGLIO**

Perfettamente integrata nel design della pensilina, la grondaia convoglia l'acqua verso gli scarichi laterali eliminando quei fastidiosi gocciolamenti davanti alla porta. Dal lato opposto invece, il profilo in alluminio provvisto di guarnizione in gomma morbida, evita le infiltrazioni lungo il muro. Viti, supporti ed ogni elemento terminale sono accuratamente nascosti alla vista da adeguate coperture in tinta.

### **CERTIFICATE**

Sono costruite in Italia e garantite contro la corrosione e l'ingiallimento della copertura. Nelle condizioni di prova così come certificate da ISTDIL, sono in grado di sopportare carichi fino a 200 kg al metro quadrato (\*).

(\*) La verifica in base alle condizioni ambientali, secondo la norma D.M. del 14-01-2008, è a cura del cliente.

# TRENDY MOD. TR-01



## Pensilina TRENDY Mod. TR-01

Larghezza 2,70, sporgenza 1,00

Struttura: RAL 9016

Mensole: Orange AK38V Grinz

Copertura: Trasparente

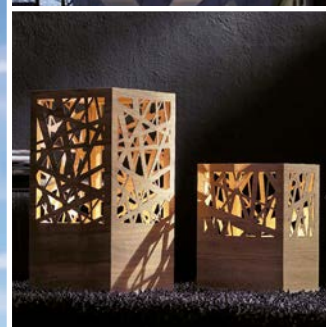

## CARATTERISTICHE TECNICHE

Pensilina a sbalzo disponibile nelle misure standard e su misura, composta da:

- Mensole portanti in acciaio sagomato dotate, nel loro intradosso, di apposito sistema premi-lastra in lega di alluminio 6060/T5 brevettato, con funzione di bloccaggio della copertura, senza interposizione di guarnizioni o fissaggi puntiformi per consentirne il libero movimento generato dalle escursioni termiche.
- Profilo di rifinitura a muro in lega di alluminio 6060/T5, atto a contenere la lastra di copertura, dotato di guarnizione per evitare le infiltrazioni di acqua fra muro e pensilina.
- Grondaia in lega di alluminio estruso 6060/T5, atta a contenere la lastra di copertura, dotata di terminali di scolo.
- Copertura in vetro acrilico anti-urto resistente ai raggi UV di spessore 4 mm, alloggiata all'interno delle scanalature ricavate nel profilo di rifinitura e nella grondaia.

Prodotto fornito in Kit corredato di viteria in acciaio inox AISI 304 non a vista. Tutte le parti in metallo sono trattate con processi anti-corrosione verniciate a polveri di poliestere nei colori di serie o su richiesta.

## PERSONALIZZAZIONI



Angoli esterni e interni



Variazione di pendenza



Larghezze su misura

**COLORE**  
DI SERIE



**Struttura:** RAL 9006 Grinz  
**Copertura:** Neutro satinato

**VARIANTI**  
COLORE



**Struttura:** RAL 9010 Grinz  
**Mensole:** Porpora AK39V Grinz  
**Copertura:** Trasparente

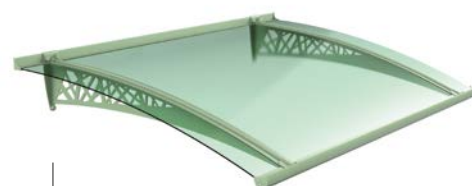

**Struttura:** RAL 6021 Grinz  
**Copertura:** Verde bottiglia



**Struttura:** Corten V001V Grinz Mix  
**Copertura:** Bronzo



**Struttura:** RAL 9005 Grinz  
**Copertura:** Solar control

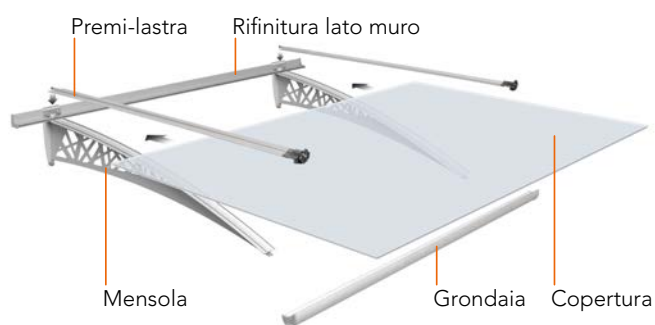

DIMENSIONI				
<b>S</b> mt	<b>0,75</b>	<b>1,00</b>	<b>1,25</b>	<b>1,50</b>
<b>A</b> mm	165	205	240	280
<b>C</b> mm	45	65	80	90

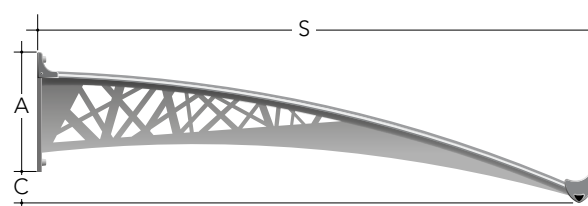

## TRENDY MOD. TR-05



### **Pensilina TRENDY Mod. TR-05**

Larghezza 1,60, sporgenza 1,00  
Struttura: RAL 9010  
Capriata: RAL 6021  
Copertura: Trasparente

### **VELA Mod. VL-01**

Sporgenza 0,75, altezza 1,80  
Struttura: RAL 9010  
Mensole: RAL 6021  
Pannello: Trasparente

## | CARATTERISTICHE TECNICHE

Pensilina a sbalzo disponibile nelle misure standard, composta da:

- Trave portante centrale in acciaio tubolare e capriata in acciaio sagomato fissata all'estremità della mensola portante e dotata, nel proprio intradosso, di apposito sistema premi-lastra in lega di alluminio 6060/T5 brevettato, con funzione di bloccaggio della copertura, senza interposizione di guarnizioni o fissaggi puntiformi per consentirne il libero movimento generato dalle escursioni termiche.
- Profilo di rifinitura a muro in lega di alluminio 6060/T5, atto a contenere le lastre di copertura, dotato di guarnizione per evitare le infiltrazioni di acqua fra muro e pensilina.
- Grondaie laterali in lega di alluminio estruso 6060/T5, atte a contenere le lastre di copertura, dotate di terminali di scolo.
- Copertura in vetro acrilico anti-urto resistente ai raggi UV di spessore 4 mm, alloggiata all'interno delle scanalature ricavate nel profilo di rifinitura, nella trave portante e nelle grondaie.

Prodotto fornito in Kit corredato di viteria in acciaio inox AISI 304 non a vista. Tutte le parti in metallo sono trattate con processi anti-corrosione verniciate a polveri di poliestere nei colori di serie o su richiesta.

**COLORE**  
DI SERIE



**Struttura:** RAL 9006 Grinz  
**Copertura:** Neutro satinato

**VARIANTI**  
COLORE



**Struttura:** RAL 9010 Grinz  
**Capriata:** RAL 5010 Grinz,  
**Copertura:** Trasparente



**Struttura:** RAL 6021 Grinz  
**Copertura:** Verde bottiglia



**Struttura:** Corten V001V Grinz Mix  
**Copertura:** Bronzo



**Struttura:** Antracite P016V Grinz  
**Copertura:** Solar control

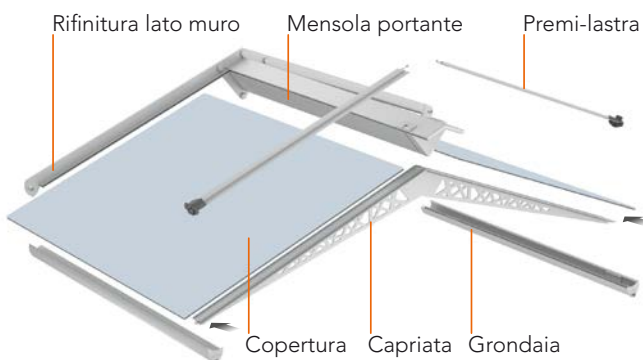

DIMENSIONI		
<b>LT</b> mt	<b>1,6</b>	<b>2,0</b>
<b>Sporgenza</b> mt	1,0	1,0
<b>HT</b> mm	365	440

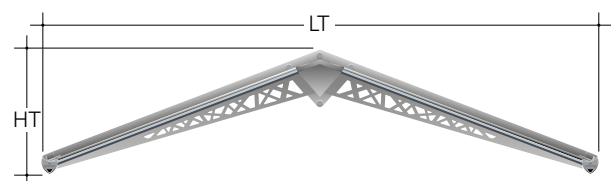

# NEWSTYLE MOD. NS-01



## Pensilina NEWSTYLE Mod. NS-01

Larghezza 2,70, sporgenza 1,00  
Struttura: RAL 9010  
Copertura: Neutro satinato

## VELA Mod. VL-01

Sporgenza 0,75, altezza 1,80  
Struttura: RAL 9010  
Pannello: Neutro satinato



## CARATTERISTICHE TECNICHE

Pensilina a sbalzo disponibile nelle misure standard e su misura, composta da:

- Mensole portanti in acciaio sagomato dotate, nel loro intradosso, di apposito sistema premilastra in lega di alluminio 6060/T5 brevettato, con funzione di bloccaggio della copertura, senza interposizione di guarnizioni o fissaggi puntiformi per consentirne il libero movimento generato dalle escursioni termiche.
- Profilo di rifinitura a muro in lega di alluminio 6060/T5, atto a contenere la lastra di copertura, dotato di guarnizione per evitare le infiltrazioni di acqua fra muro e pensilina.
- Grondaia in lega di alluminio estruso 6060/T5, atta a contenere la lastra di copertura, dotata di terminali di scolo.
- Copertura in vetro acrilico anti-urto resistente ai raggi UV di spessore 4 mm, alloggiata all'interno delle scanalature ricavate nel profilo di rifinitura e nella grondaia.

Prodotto fornito in Kit corredato di viteria in acciaio inox AISI 304 non a vista. Tutte le parti in metallo sono trattate con processi anti-corrosione verniciate a polveri di poliestere nei colori di serie o su richiesta.

## PERSONALIZZAZIONI



Angoli esterni e interni



Variazione di pendenza



Larghezze su misura



Mensole inox



**COLORE**  
DI SERIE



**Struttura:** RAL 9006 Grinz  
**Copertura:** Neutro satinato

**VARIANTI**  
COLORE



Acciaio inox  
AISI 316L satinato



**Struttura:** RAL 9010 Grinz  
**Mensole:** Acciaio inox (su richiesta)  
**Copertura:** Trasparente

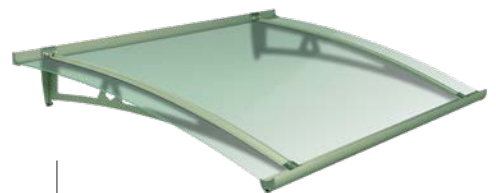

**Struttura:** RAL 6021 Grinz  
**Copertura:** Verde bottiglia

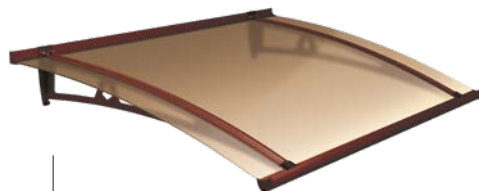

**Struttura:** Corten V001V Grinz Mix  
**Copertura:** Bronzo



**Struttura:** Antracite P016V Grinz  
**Copertura:** Solar control



		DIMENSIONI								
S mt		0,75	1,00	1,25	1,50	BALC.	0,75	1,00	1,25	1,50
A mm	STANDARD	165	205	240	280		100	100	120	120
C mm.		45	65	80	90		120	170	200	250
D mm.		-	-	-	-	SOTTO BALC.	240	315	390	450

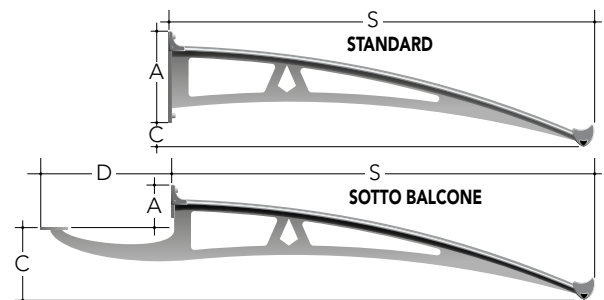

## NEWSTYLE MOD. NS-02



### **Pensilina NEWSTYLE Mod. NS-02**

Larghezza 1,60, sporgenza 1,00

Struttura: RAL 9005

Copertura: Trasparente

## | CARATTERISTICHE TECNICHE

Pensilina a sbalzo disponibile nelle misure standard, composta da:

- Mensole portanti in acciaio sagomato e capriata in acciaio sagomato fissata alle estremità delle mensole portanti e dotata, nel proprio intradosso, di apposito sistema premi-lastra in lega di alluminio 6060/T5 brevettato, con funzione di bloccaggio della copertura, senza interposizione di guarnizioni o fissaggi puntiformi per consentirne il libero movimento generato dalle escursioni termiche.
- Profilo di rifinitura in lega di alluminio 6060/T5, atto a contenere le lastre di copertura, dotato di guarnizione per evitare le infiltrazioni di acqua fra muro e pensilina.
- Giunzione del colmo in lega di alluminio 6060/T5, atto a contenere le lastre di copertura.
- Grondaie in lega di alluminio estruso 6060/T5, atte a contenere le lastre di copertura, dotate di terminali di scolo.
- Copertura in vetro acrilico anti-urto resistente ai raggi UV di spessore 4 mm, alloggiata all'interno delle scanalature ricavate nel profilo di rifinitura e nelle grondaie.

Prodotto fornito in Kit corredato di viteria in acciaio inox AISI 304 non a vista. Tutte le parti in metallo sono trattate con processi anti-corrosione verniciate a polveri di poliestere nei colori di serie o su richiesta.

**COLORE**  
DI SERIE



**Struttura:** RAL 9006 Grinz  
**Copertura:** Neutro satinato

**VARIANTI**  
COLORE



**Struttura:** RAL 3003 Grinz  
**Copertura:** Trasparente



**Struttura:** RAL 6021 Grinz  
**Copertura:** Verde bottiglia



**Struttura:** Avorio AK16V Grinz  
**Copertura:** Bronzo



**Struttura:** RAL 9010 Grinz  
**Copertura:** Solar control

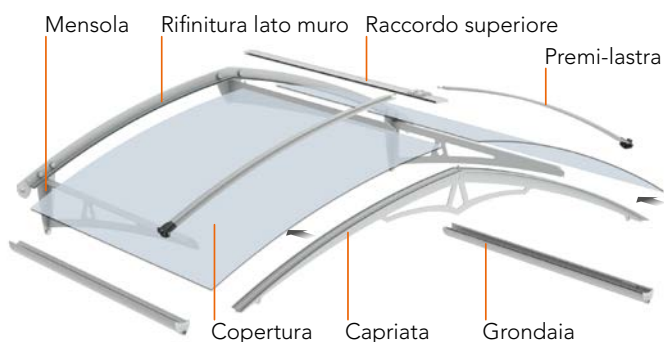

DIMENSIONI			
<b>LT</b> mt	<b>1,6</b>	<b>2,0</b>	<b>2,4</b>
<b>Sporgenza</b> mt	1,0	1,0	1,0
<b>HT</b> mm	470	540	610
<b>IM</b> mm	1400	1800	2200

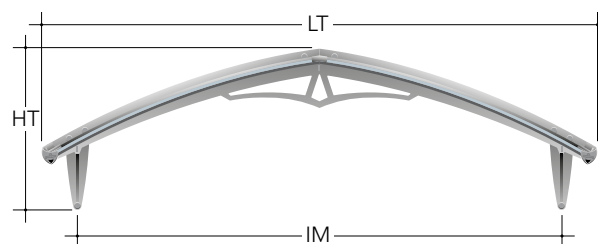

# OLDSTYLE MOD. OS-01



## Pensilina OLDSTYLE Mod. OS-01

Larghezza 3,90, sporgenza 1,00

Struttura: Antracite P016V Grinz

Copertura: Neutro satinato

## CARATTERISTICHE TECNICHE

Pensilina a sbalzo disponibile nelle misure standard e su misura, composta da:

- Mensole portanti in acciaio sagomato dotate, nel loro intradosso, di apposito sistema premilastra in lega di alluminio 6060/T5 brevettato, con funzione di bloccaggio della copertura, senza interposizione di guarnizioni o fissaggi puntiformi per consentirne il libero movimento generato dalle escursioni termiche.
- Profilo di rifinitura a muro in lega di alluminio 6060/T5, atto a contenere la lastra di copertura, dotato di guarnizione per evitare le infiltrazioni di acqua fra muro e pensilina.
- Grondaia in lega di alluminio estruso 6060/T5, atta a contenere la lastra di copertura, dotata di terminali di scolo.
- Copertura in vetro acrilico anti-urto resistente ai raggi UV di spessore 4 mm, alloggiata all'interno delle scanalature ricavate nel profilo di rifinitura e nella grondaia.

Prodotto fornito in Kit corredato di viteria in acciaio inox AISI 304 non a vista. Tutte le parti in metallo sono trattate con processi anti-corrosione verniciate a polveri di poliestere nei colori di serie o su richiesta.

## PERSONALIZZAZIONI



Angoli esterni e interni



Variazione di pendenza



Larghezze su misura

**COLORE**  
DI SERIE



**Struttura:** Antracite P016V Grinz  
**Copertura:** Neutro satinato

**VARIANTI**  
COLORE



**Struttura:** RAL 9006 Grinz  
**Copertura:** Trasparente

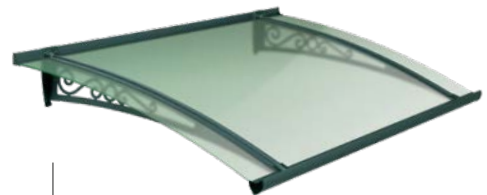

**Struttura:** RAL 6005 Grinz  
**Copertura:** Verde bottiglia

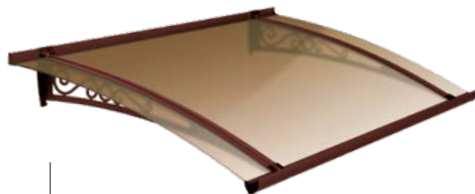

**Struttura:** Corten V001V Grinz Mix  
**Copertura:** Bronzo



**Struttura:** Antracite P016V Grinz  
**Copertura:** Solar control



DIMENSIONI				
<b>S</b> mt	<b>0,75</b>	<b>1,00</b>	<b>1,25</b>	<b>1,50</b>
<b>A</b> mm	165	205	240	280
<b>C</b> mm	45	65	80	90

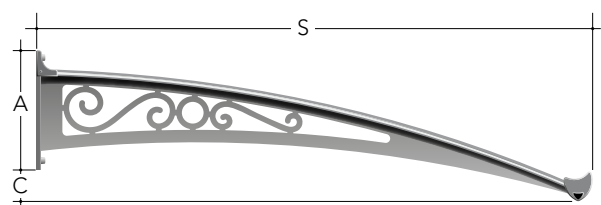

## OLDSTYLE MOD. OS-02



### **Pensilina OLDSTYLE Mod. OS-02**

Larghezza 1,60, sporgenza 1,00

Struttura: RAL 8017

Copertura: Bronzo

### **VELA Mod. VL-01**

Larghezza 0,75, altezza 1,80

Struttura: RAL 8017

Pannello: Bronzo

## | CARATTERISTICHE TECNICHE

Pensilina a sbalzo disponibile nelle misure standard, composta da:

- Mensole portanti in acciaio sagomato e capriata in acciaio sagomato fissata alle estremità delle mensole portanti e dotata, nel proprio intradosso, di apposito sistema premi-lastra in lega di alluminio 6060/T5 brevettato, con funzione di bloccaggio della copertura, senza interposizione di guarnizioni o fissaggi puntiformi per consentirne il libero movimento generato dalle escursioni termiche.
- Profilo a muro in lega di alluminio 6060/T5, atto a contenere le lastre di copertura, dotato di guarnizione per evitare le infiltrazioni di acqua fra muro e pensilina.
- Giunzione del colmo in lega di alluminio 6060/T5, atto a contenere le lastre di copertura.
- Grondaie in lega di alluminio estruso 6060/T5, atte a contenere le lastre di copertura, dotate di terminali di scolo.
- Copertura in vetro acrilico anti-urto resistente ai raggi UV di spessore 4 mm, alloggiata all'interno delle scanalature ricavate nel profilo di rifinitura e nelle grondaie.

Prodotto fornito in Kit corredato di viteria in acciaio inox AISI 304 non a vista. Tutte le parti in metallo sono trattate con processi anti-corrosione verniciate a polveri di poliestere nei colori di serie o su richiesta.

**COLORE**  
DI SERIE



**Struttura:** Antracite P016V Grinz  
**Copertura:** Neutro satinato

**VARIANTI**  
COLORE



**Struttura:** RAL 5003 Grinz  
**Copertura:** Trasparente



**Struttura:** Verde P 7100 Mix  
**Copertura:** Verde bottiglia



**Struttura:** Corten V001V Grinz Mix  
**Copertura:** Bronzo



**Struttura:** RAL 9006 Grinz  
**Copertura:** Solar control

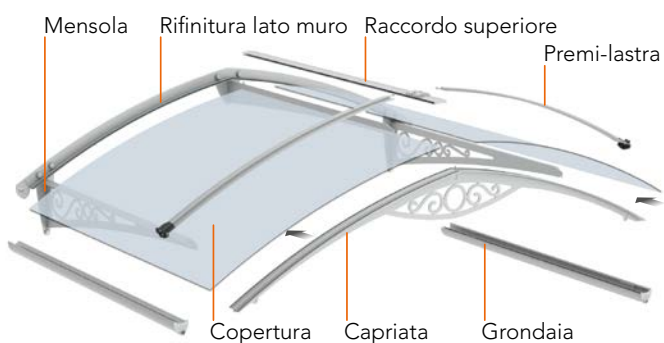

DIMENSIONI			
<b>LT</b> mt	<b>1,6</b>	<b>2,0</b>	<b>2,4</b>
<b>Sporgenza</b> mt	1,0	1,0	1,0
<b>HT</b> mm	470	540	610
<b>IM</b> mm	1400	1800	2200

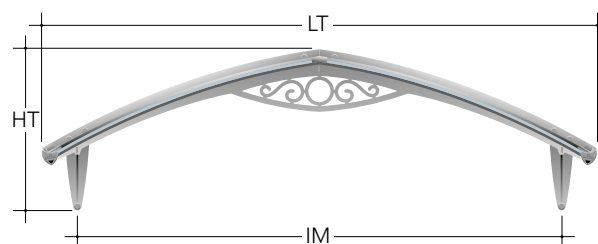

# LIBERTY MOD. LT-01



**Pensilina LIBERTY Mod. LT-01**  
Larghezza 2,30, sporgenza 1,30  
Struttura: Antracite P016V Grinz  
Copertura: Neutro satinato

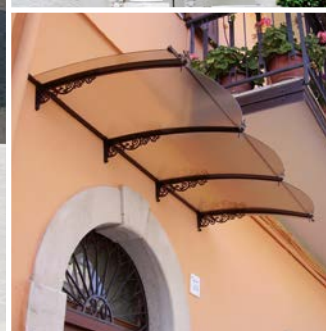
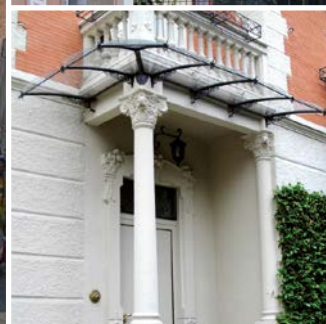

## CARATTERISTICHE TECNICHE

Pensilina a sbalzo disponibile nelle misure standard e su misura, composta da:

- Mensole portanti in acciaio sagomato dotate, nel loro intradosso, di apposito sistema premilastra in lega di alluminio 6060/T5 brevettato, con funzione di bloccaggio della copertura, senza interposizione di guarnizioni o fissaggi puntiformi per consentirne il libero movimento generato dalle escursioni termiche.
- Profilo di rifinitura a muro in lega di alluminio 6060/T5, atto a contenere la lastra di copertura, dotato di guarnizione per evitare le infiltrazioni di acqua fra muro e pensilina.
- Tiranti in lega di alluminio estruso 6060/T5, atti a distanziare le mensole e sorreggere le lastre di copertura dal lato estremo della sporgenza.
- Copertura in vetro acrilico anti-urto resistente ai raggi UV di spessore 4 mm, con forma arrotondata dalla parte spiovente, alloggiata all'interno delle scanalature ricavate nel profilo di rifinitura.

Prodotto fornito in Kit corredato di viteria in acciaio inox AISI 304 non a vista. Tutte le parti in metallo sono trattate con processi anti-corrosione verniciate a polveri di poliestere nei colori di serie o su richiesta.

## PERSONALIZZAZIONI



Variazione di pendenza



Larghezze su misura



**COLORE**  
DI SERIE



**Struttura:** Antracite P016V Grinz  
**Copertura:** Neutro satinato

**VARIANTI**  
COLORE



**Struttura:** RAL 3005 Grinz  
**Copertura:** Trasparente



**Struttura:** RAL 6005 Grinz  
**Copertura:** Verde bottiglia



**Struttura:** Ambra AK40V Grinz  
**Copertura:** Bronzo



**Struttura:** Antracite P016V Grinz  
**Copertura:** Solar control

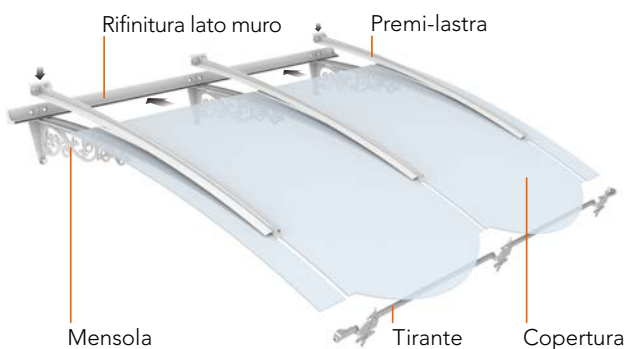

DIMENSIONI			
<b>S</b> mt	<b>0,7</b>	<b>1,0</b>	<b>1,3</b>
<b>A</b> mm	155	175	220
<b>C</b> mm	20	70	80

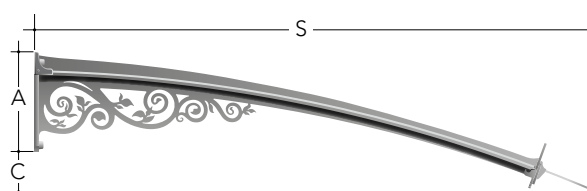



**Pensilina Mod. EGO' - F**  
 (con FLAP laterali non di serie)  
 Larghezza 1,60, sporgenza 0,95  
 Mensole: Antracite P016V Grinz  
 Grondaia: Argento satinato  
 Copertura: Frosted



PROTETTIVA

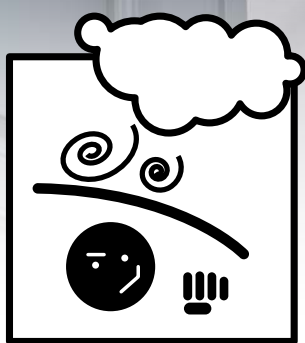

ROBUSTA



NON ARRUGGINISCE

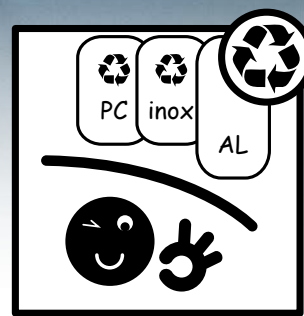

RICICLABILE 100%

## CARATTERISTICHE TECNICHE

Mensole portanti in acciaio trattate contro la corrosione, verniciate con polveri epossidiche colore antracite di serie (altri colori a richiesta). Grondaia e sovrastruttura in alluminio estruso 6060/T5, colore argento satinato (unica finitura disponibile). Copertura in policarbonato semitrasparente con protezione UV, in finitura Frosted (unica finitura disponibile). Viteria per l'installazione fornita di serie.

## PERSONALIZZAZIONI

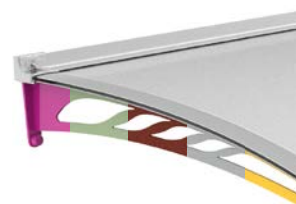

Mensole disponibili in tutte le finiture della cartella Aluform (a richiesta).



**CON IL SISTEMA MODULARE OTTENERE LARGHEZZE SU MISURA È SEMPLICISSIMO.**

PENSILINA **egò** è un sistema modulare che ti permette di realizzare rapidamente la soluzione più adatta alle tue esigenze. Combinando gli elementi della PENSILINA BASE e dei MODULI AGGIUNTIVI, disponibili in varie larghezze, potrai costruire con estrema facilità la tua pensilina nella misura desiderata. Con i FLAP laterali opzionali, puoi inoltre prolungare e rifinire la copertura della pensilina, un sistema funzionale per rendere unico il tuo ingresso.

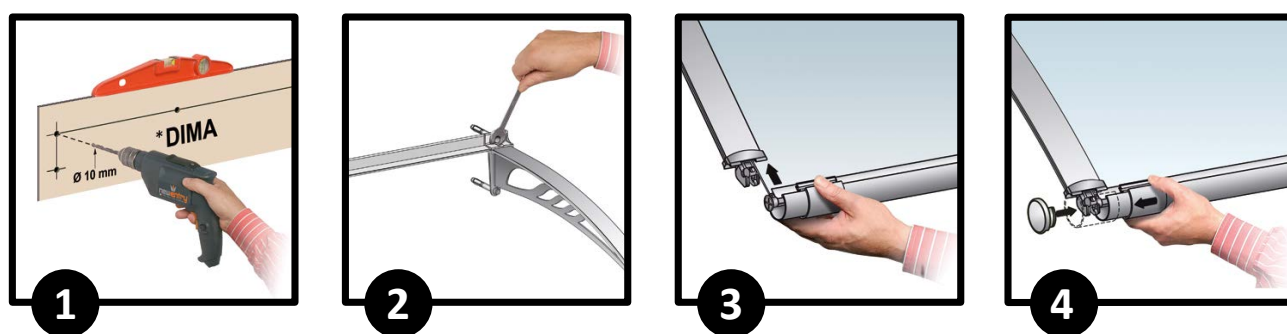
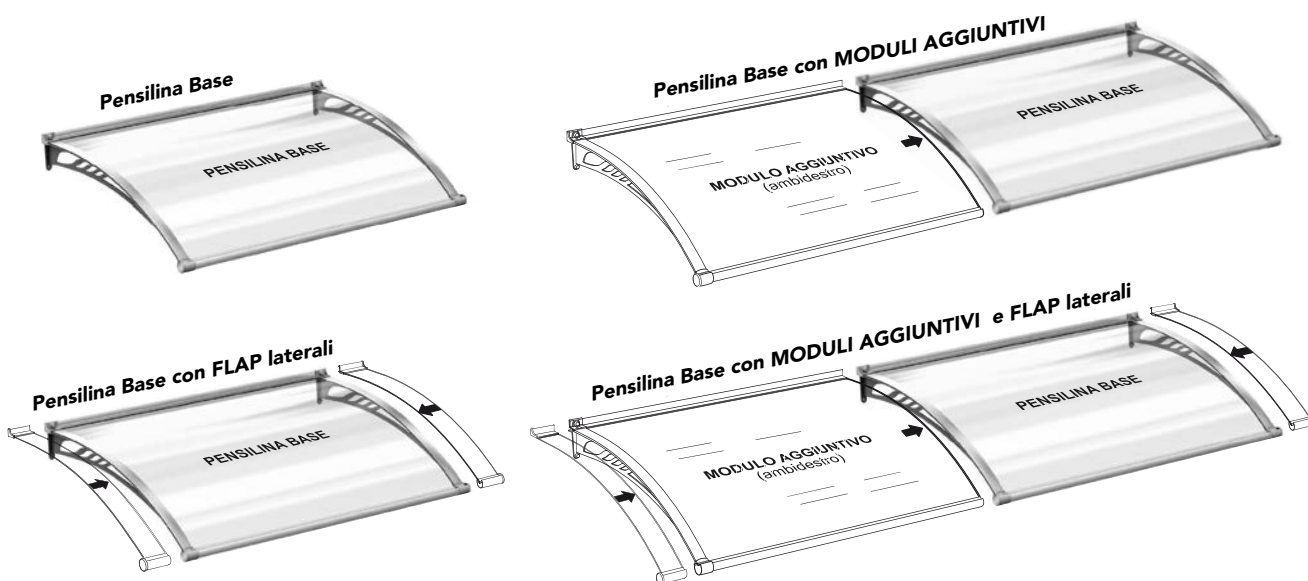

DIMENSIONI			
<b>S</b> mt	<b>0,65</b>	<b>0,95</b>	<b>1,25</b>
<b>A</b> mm	116	146	201
<b>C</b> mm	125	205	247

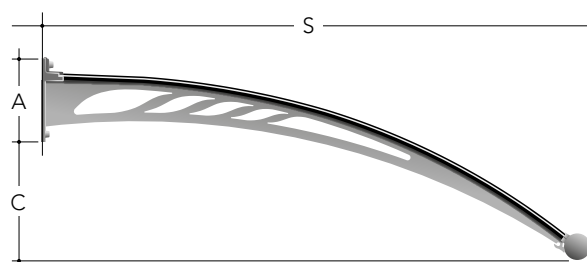

# DIMENSIONI

## TRENDY

MODELLO TR-01



## NEWSTYLE

MODELLO NS-01



## OLDSTYLE

MODELLO OS-01



S. 0,75 (CR 200 kg/mq)			S. 1,00 (CR 200 kg/mq)			S. 1,25 (CR 200 kg/mq)			S. 1,50 (CR 100 kg/mq)			S. 1,50 (CR 200 kg/mq) -SU RICHIESTA -		
Largh. Tot.	Moduli		Largh. Tot.	Moduli		Largh. Tot.	Moduli		Largh. Tot.	Moduli		Largh. Tot.	Moduli	
	N°	IM		N°	IM		N°	IM		N°	IM		N°	IM
1,40	1	1,10	1,50	1	1,20	2,00	2	0,85	2,30	2	1,00	2,00	2	0,85
1,70	1	1,40	2,00	2	0,85	2,30	2	1,00	3,30	3	1,00	2,85	3	0,85
2,20	2	0,95	2,70	2	1,20	3,30	3	1,00	4,30	4	1,00	3,70	4	0,85
3,10	2	1,40	3,90	3	1,20	4,30	4	1,00	5,30	5	1,00	4,55	5	0,85
4,50	3	1,40	5,10	4	1,20	5,30	5	1,00	6,30	6	1,00	5,40	6	0,85
5,90	4	1,40	6,30	5	1,20	6,30	6	1,00	7,30	7	1,00	6,25	7	0,85
7,30	5	1,40	7,50	6	1,20	7,30	7	1,00	8,30	8	1,00	7,10	8	0,85
8,70	6	1,40	8,70	7	1,20	8,30	8	1,00	9,30	9	1,00	7,95	9	0,85
10,10	7	1,40	9,90	8	1,20	9,30	9	1,00	10,30	10	1,00	8,80	10	0,85
11,50	8	1,40	11,10	9	1,20	10,30	10	1,00	11,30	11	1,00	9,65	11	0,85
12,90	9	1,40	12,30	10	1,20	11,30	11	1,00	12,30	12	1,00	10,50	12	0,85
14,30	10	1,40	13,50	11	1,20	12,30	12	1,00	13,30	13	1,00	11,35	13	0,85
15,70	11	1,40	14,70	12	1,20	13,30	13	1,00	14,30	14	1,00	12,20	14	0,85
17,10	12	1,40	15,90	13	1,20	14,30	14	1,00	15,30	15	1,00	13,05	15	0,85
18,50	13	1,40	17,10	14	1,20	15,30	15	1,00	16,30	16	1,00	13,90	16	0,85
19,90	14	1,40	18,30	15	1,20	16,30	16	1,00	17,30	17	1,00	14,75	17	0,85
21,30	15	1,40	19,50	16	1,20	17,30	17	1,00	18,30	18	1,00	15,60	18	0,85
22,70	16	1,40	20,70	17	1,20	18,30	18	1,00	19,30	19	1,00	16,45	19	0,85
24,10	17	1,40	21,90	18	1,20	19,30	19	1,00	20,30	20	1,00	17,30	20	0,85
25,50	18	1,40	23,10	19	1,20	20,30	20	1,00	21,30	21	1,00	18,15	21	0,85
26,90	19	1,40	24,30	20	1,20	21,30	21	1,00	22,30	22	1,00	19,00	22	0,85
28,30	20	1,40	25,50	21	1,20	22,30	22	1,00	23,30	23	1,00	19,85	23	0,85
29,70	21	1,40	26,70	22	1,20	23,30	23	1,00	24,30	24	1,00	20,70	24	0,85
31,10	22	1,40	27,90	23	1,20	24,30	24	1,00	25,30	25	1,00	21,55	25	0,85
32,50	23	1,40	29,10	24	1,20	25,30	25	1,00	26,30	26	1,00	22,40	26	0,85
33,90	24	1,40	30,30	25	1,20	26,30	26	1,00	27,30	27	1,00	23,25	27	0,85
35,30	25	1,40	31,50	26	1,20	27,30	27	1,00	28,30	28	1,00	24,10	28	0,85
36,70	26	1,40	32,70	27	1,20	28,30	28	1,00	29,30	29	1,00	24,95	29	0,85
38,10	27	1,40	33,90	28	1,20	29,30	29	1,00	30,30	30	1,00	25,80	30	0,85

### SPORGENZA PENSILINA (mt)

0,75 1,00 1,25 1,50

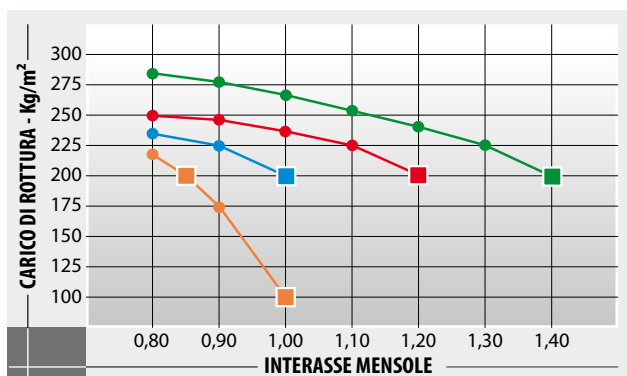

Ad eccezione dei modelli con sporgenza mt. 1,5, il cui carico di 200 kg/mq è su richiesta, tutte le altre pensiline sono realizzate di serie per sopportare un carico uniformemente distribuito di 200 kg/mq. (\*) A richiesta, riducendo gli interassi fra le mensole, è possibile aumentare i carichi.

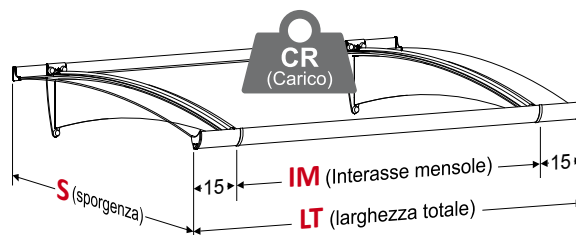

(\*) I carichi indicati sono garantiti nelle condizioni di prova statica come certificate da ISTDIL. La verifica, secondo la norma D.M. del 14-01-2008, è a cura dell'installatore.

**LIBERTY**  
MODELLO LT-01



<b>S. 0,70</b> (CR 200 kg/mq)			<b>S. 1,00</b> (CR 200 kg/mq)			<b>S. 1,30</b> (CR 200 kg/mq)		
Larghezza	Moduli		Larghezza	Moduli		Larghezza	Moduli	
	N°	IM		N°	IM		N°	IM
1,10	2	0,45	1,40	2	0,60	1,60	2	0,70
1,55	3	0,45	2,00	3	0,60	2,30	3	0,70
2,00	4	0,45	2,60	4	0,60	3,00	4	0,70
2,45	5	0,45	3,20	5	0,60	3,70	5	0,70
2,90	6	0,45	3,80	6	0,60	4,40	6	0,70
3,35	7	0,45	4,40	7	0,60	5,10	7	0,70
3,80	8	0,45	5,00	8	0,60	5,80	8	0,70
4,25	9	0,45	5,60	9	0,60	6,50	9	0,70
4,70	10	0,45	6,20	10	0,60	7,20	10	0,70
5,15	11	0,45	6,80	11	0,60	7,90	11	0,70
5,60	12	0,45	7,40	12	0,60	8,60	12	0,70
6,05	13	0,45	8,00	13	0,60	9,30	13	0,70
6,50	14	0,45	8,60	14	0,60	10,00	14	0,70
6,95	15	0,45	9,20	15	0,60	10,70	15	0,70
7,40	16	0,45	9,80	16	0,60	11,40	16	0,70
7,85	17	0,45	10,40	17	0,60	12,10	17	0,70
8,30	18	0,45	11,00	18	0,60	12,80	18	0,70
8,75	19	0,45	11,60	19	0,60	13,50	19	0,70
9,20	20	0,45	12,20	20	0,60	14,20	20	0,70
9,65	21	0,45	12,80	21	0,60	14,90	21	0,70
10,10	22	0,45	13,40	22	0,60	15,60	22	0,70
10,55	23	0,45	14,00	23	0,60	16,30	23	0,70
11,00	24	0,45	14,60	24	0,60	17,00	24	0,70
11,45	25	0,45	15,20	25	0,60	17,70	25	0,70
11,90	26	0,45	15,80	26	0,60	18,40	26	0,70
12,35	27	0,45	16,40	27	0,60	19,10	27	0,70
12,80	28	0,45	17,00	28	0,60	19,80	28	0,70
13,25	29	0,45	17,60	29	0,60	20,50	29	0,70
13,70	30	0,45	18,20	30	0,60	21,20	30	0,70

**SPORGENZA PENSILINA (mt)**

**0,70 1,00 1,30**

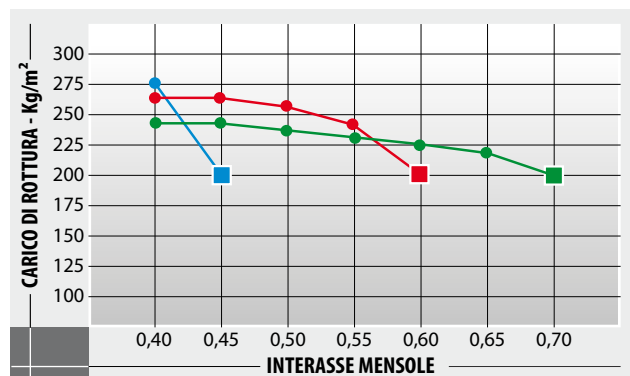

Realizzate di serie, per carico uniformemente distribuito di 200 kg/mq. (\*)

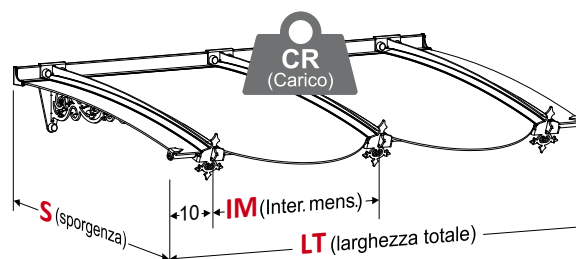

(\*) I carichi indicati sono garantiti nelle condizioni di prova statica come certificate da ISTDIL. La verifica, secondo la norma D.M. del 14-01-2008, è a cura dell'installatore.

# DIMENSIONI

## TRENDY

MODELLO TR-05



S. 1,00 - (CR 200 kg/mq)	
LT	IM
Larghezza Totale	Inter. Mens.
1,60	-
2,00	-

## NEWSTYLE

MODELLO NS-02



S. 1,00 - (CR 200 kg/mq)	
LT	IM
Larghezza Totale	Inter. Mens.
1,60	1,40
2,00	1,80
2,40	2,20

## OLDSTYLE

MODELLO OS-02



S. 1,00 - (CR 200 kg/mq)	
LT	IM
Larghezza Totale	Inter. Mens.
1,60	1,40
2,00	1,80
2,40	2,20

SPORGENZA PENSILINA (mt)

1,00

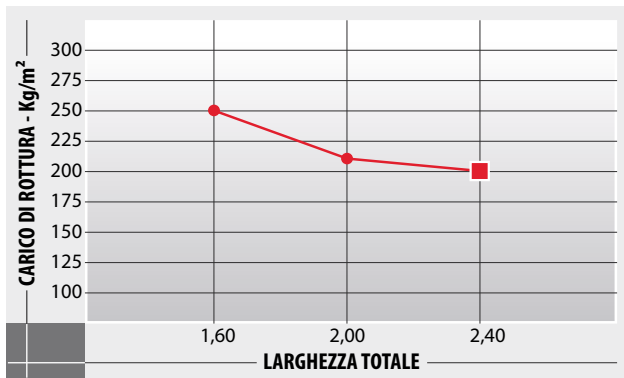

Realizzate di serie, per carico uniformemente distribuito di 200 kg/mq. (\*)

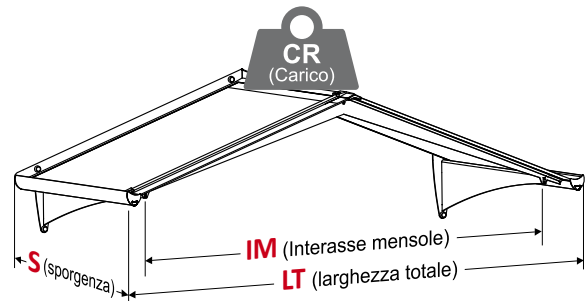

## EGO'



S. 0,65			S. 0,95			S. 1,25		
Tipologia Modulo	LM Largh. Mod.	IM Inter. Mod.	Tipologia Modulo	LM Largh. Mod.	IM Inter. Mod.	Tipologia Modulo	LM Largh. Mod.	IM Inter. Mod.
Base	1,46	1,40	Base	1,46	1,40	Base	1,26	1,20
	1,26	1,20		1,26	1,20		1,06	1,00
	1,06	1,00		1,06	1,00		0,86	0,80
	0,86	0,80		0,86	0,80			
Aggiuntivo	1,40	1,40	Aggiuntivo	1,40	1,40	Aggiuntivo	1,20	1,20
	1,20	1,20		1,20	1,20		1,00	1,00
	1,00	1,00		1,00	1,00		0,80	0,80
	0,80	0,80		0,80	0,80			
Flap	0,07 x 2		Flap	0,07 x 2		Flap	0,07 x 2	

SPORGENZA PENSILINA (mt)

0,65 0,95 1,25

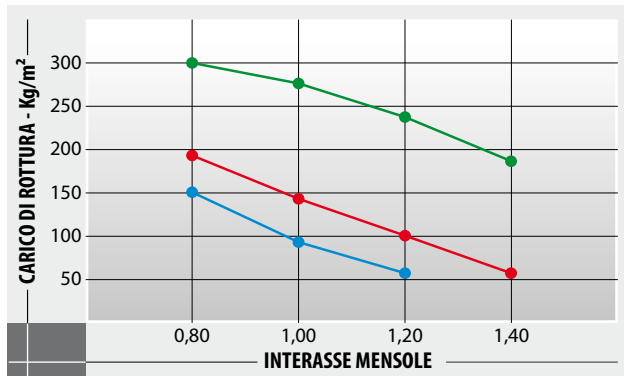

Realizzate di serie, per carico uniformemente distribuito come riportato nella tabella a fianco.

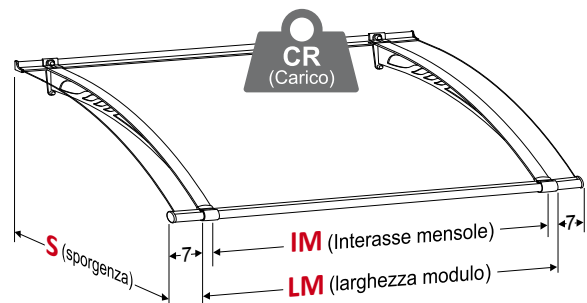

(\*) I carichi indicati sono garantiti nelle condizioni di prova statica come certificate da ISTDIL. La verifica, secondo la norma D.M. del 14-01-2008, è a cura dell'installatore.

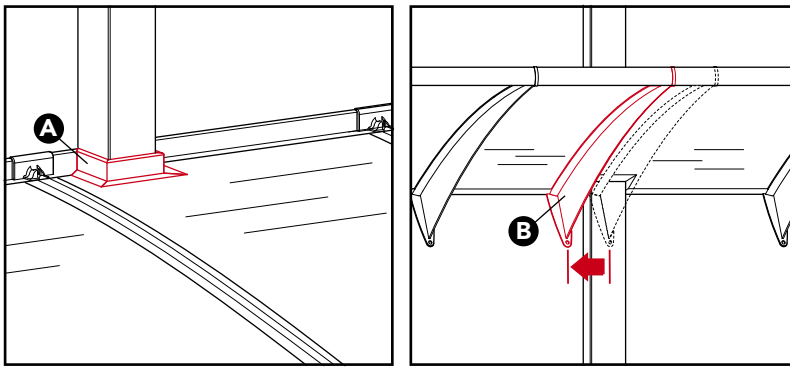

### LAVORAZIONI A RICHIESTA:

- A** - Incasso su profilo a muro e copertura, per sorpasso elementi discendenti come: tubi, cavi, pilastri, camini, ecc.
- B** - Mensola con interasse spostato rispetto al passo di serie.

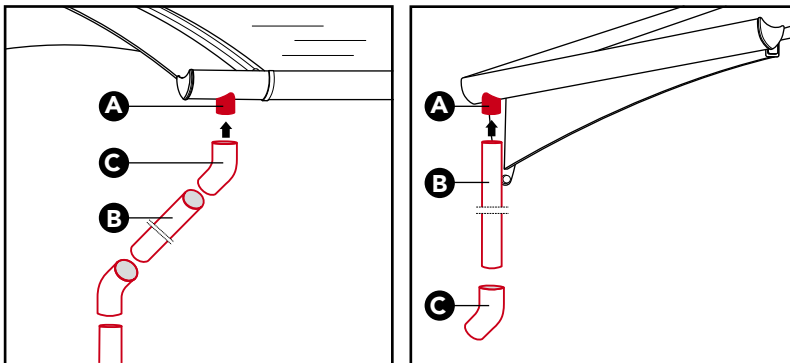

### CANALIZZAZIONI PER SCOLO ACQUA

- A** - Imbocco per tubazione di scolo su grondaia.
- B** - Tubazione di scolo  $\varnothing$  28 mm.
- C** - Curva 45° o 90° per tubazione  $\varnothing$  28 mm.

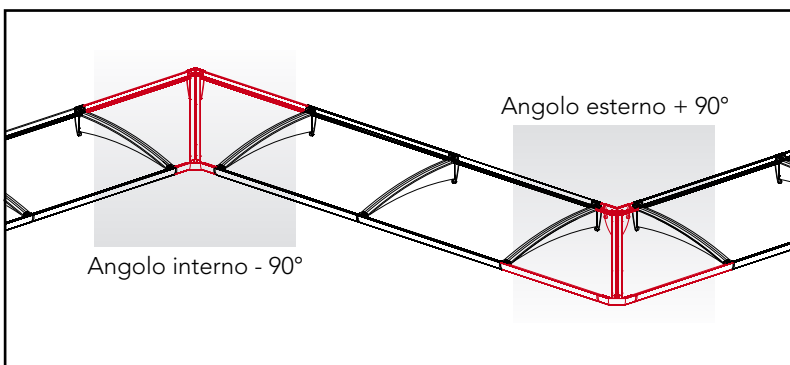

### PENSILINE AD ANGOLO

Disponibile per i modelli: TR-01, NS-01 e OS-01, sia nella gradazione standard di 90°, sia nella gradazione a richiesta.

- A** - Angolo esterno
- B** - Angolo interno
- C** - Variazione pendenza interna
- D** - Variazione pendenza esterna
- - - - Punto rilevazione misure

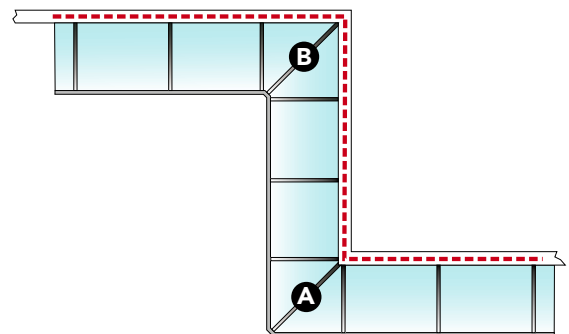
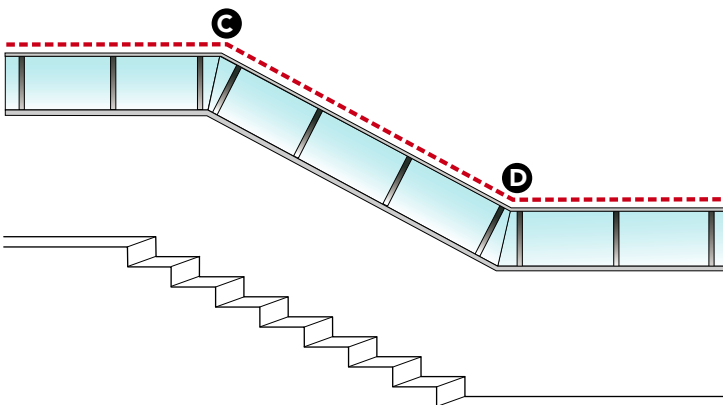

### RILIEVO MISURE DELLE PENSILINE CON ANGOLI E/O VARIAZIONI DI PENDENZA

Rilevare le misure nel punto indicato dalla linea rossa tratteggiata e nei punti di variazione di pendenza C e D, rilevare anche il grado di piega interna ed esterna.

## PRODOTTI E COMPLEMENTI



### KIT COPRICANCELLO

Struttura fornita in kit per applicazione pensiline su cancelli. Disponibile nelle dimensioni standard e su misura, composta da due colonne portanti in acciaio con altezza 1 o 2 metri, rifilabili a misura e profili orizzontali in lega di alluminio ox argento predisposti per il fissaggio delle pensiline di qualsiasi sporgenza e nella larghezza massima di due moduli. Struttura disponibile per i modelli: Trendy, Newstyle e Oldstyle. Le pensiline sono da considerare e ordinare a parte.

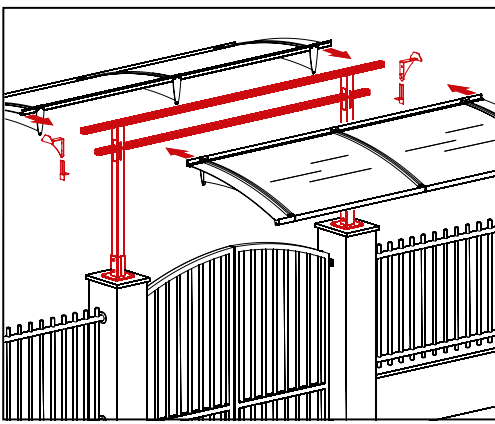

### PARETE LATERALE AMBIDESTRA "VELA"

Struttura sobria e minimale per un valido riparo laterale dell'ingresso da pioggia, grandine e vento, abbinabile a tutti i modelli di pensiline. Disponibile nelle diverse dimensioni standard, è composta da due mensole portanti in acciaio, struttura in alluminio e pannello in vetro acrilico di spessore 4 mm. Prodotto fornito di serie con struttura e mensole portanti di colore Silver e pannello neutro satinato. Tutte le parti in metallo sono trattate con processi anticorrosione e verniciate a polveri di poliestere nei colori di serie o su richiesta.

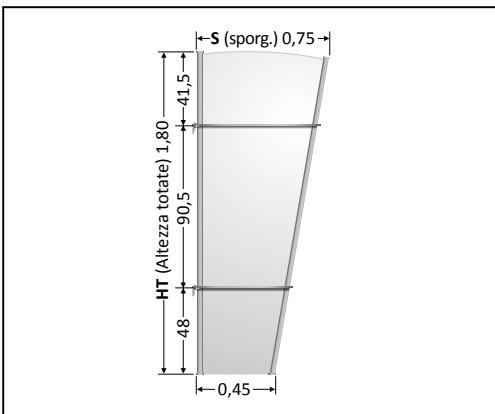





### COLORI DELLA STRUTTURA

La struttura delle pensiline è realizzata nelle finiture della gamma LAC e EXCLUSIVE, le stesse utilizzate per i pannelli della porta d'ingresso. L'esclusività di un abbinamento cromatico perfetto fra porte e pensilina che solo Aluform può offrire.



### COLORE DI SERIE



Neutro satinato

### CARATTERISTICHE E COLORI DELLE COPERTURE

La copertura delle pensiline è costituita da lastre in vetro acrilico antiurto "Poly-Plex". Per l'elevata resistenza ai raggi ultravioletti e l'ottimo grado di resistenza agli urti, le lastre in "Poly-Plex" rappresentano la migliore soluzione disponibile sul mercato per questo tipo di applicazioni.

### COLORI A RICHIESTA



Trasparente



Verde bottiglia



Bronzo



Solar control  
(Trasmittanza luminosa 50%)



Frosted

### CARATTERISTICHE DELLA COPERTURA **egò**

Copertura in policarbonato semi-trasparente con protezione UV, in finitura **Frosted**, unico colore e finitura disponibile per il modello EGO'.

**IMPORTANTE:** Per i noti limiti tecnologici di stampa, i colori della presente cartella hanno valore puramente indicativo, non possono pertanto rappresentare oggetto di raffronto per eventuali contestazioni. Per esigenze particolari vi invitiamo a richiedere un campione di materiale.

# COLORI E FINITURE

## Protezione strato dopo strato!

La resistenza dei prodotti Aluform agli agenti atmosferici ed alla corrosione è garantita dai diversi strati di trattamento dell'alluminio, conformi alle più rigorose norme di riferimento. Tutte le finiture sono realizzate con impianti interni all'avanguardia, senza uso di cromo e solventi, che assicurano risultati di altissima qualità e un ciclo di lavorazione a basso impatto ambientale.

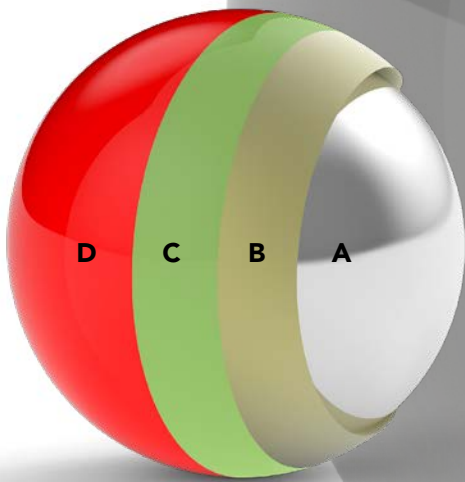

- A)** Lastra in alluminio
- B)** Fosfocromatazione
- C)** Verniciatura protettiva al titanio
- D)** Verniciatura a polveri poliesteri



## Vastissima gamma di colori e finiture

Un'infinità di colori e combinazioni con finiture laccate lucide, opache, raggrinzate e metallizzate per soddisfare ogni esigenza dell'architettura classica e contemporanea.

La collezione EFFECT, che riproduce fedelmente materiali naturali come il legno, si arricchisce delle nuove finiture tecniche effetto metallo e cemento.



### LAC

LACCATI RAL



### EXCLUSIVE

LACCATI SPECIALI



### SKIN

PELLICOLATI



### EFFECT

SUBLIMATI

#### IMPORTANTE:

Per limiti tecnologici di stampa, le finiture rappresentate in queste pagine sono da considerarsi indicative e non possono pertanto rappresentare elemento di paragone per eventuali contestazioni.

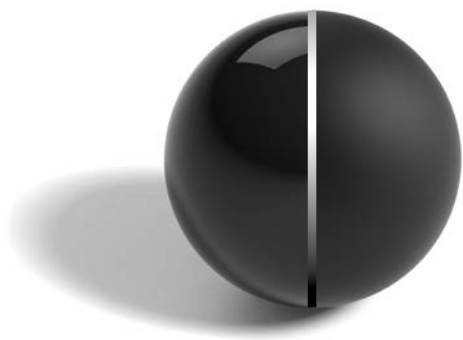

# LAC

## LACCATI RAL

---

Selezione colori della scala RAL in finitura lucida o raggrinzata opaca con caratteristiche antigraffio.

- Le finiture laccate RAL sono realizzate con vernici in polvere di poliestere polimerizzate a 180 gradi C.
- L'assortimento delle tinte RAL in pronta consegna è in costante evoluzione. Per qualsiasi esigenza che non trovi riscontro nella presente cartella, chiedete la disponibilità del codice RAL desiderato indicando la finitura superficiale: lucida, opaca o raggrinzata. In assenza di questa informazione, sia le tinte RAL in cartella, che quelle a richiesta, saranno realizzate in finitura lucida (standard).
- Per realizzare pannelli nei colori non appartenenti alla scala RAL, comunicare marca e codice del colore oppure inviare un campione di riferimento. Sarà nostra cura reperire sul mercato la vernice nel colore richiesto.
- E' anche possibile realizzare i pannelli con le vostre vernici, nel caso queste siano riservate o non reperibili sul mercato, basta inviarne 2 kg per ogni pannello. Insieme alla vernice e nello stesso documento di trasporto, inviare sempre un campione di riferimento colore, in assenza del quale non potranno essere accolte contestazioni.

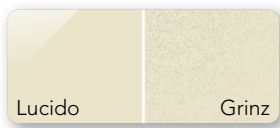

RAL 1013

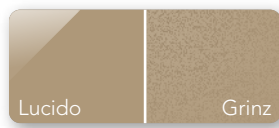

RAL 1019

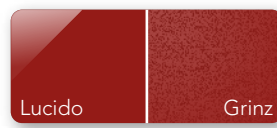

RAL 3003

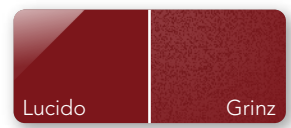

RAL 3004



RAL 3005



RAL 5003



RAL 5010

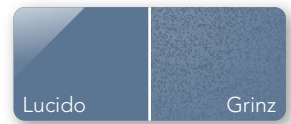

RAL 5014



RAL 6005

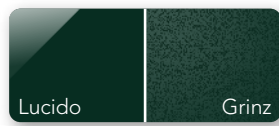

RAL 6009

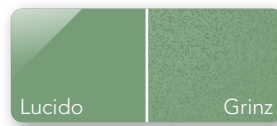

RAL 6021

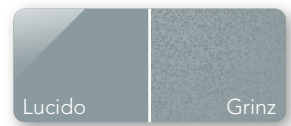

RAL 7001

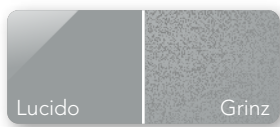

RAL 7004

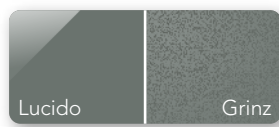

RAL 7005

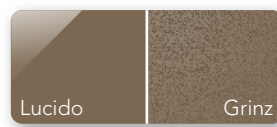

RAL 7006

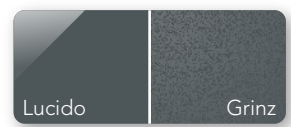

RAL 7011

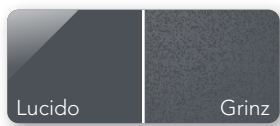

RAL 7015

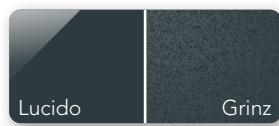

RAL 7016

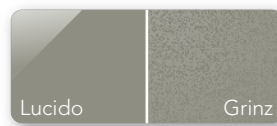

RAL 7030

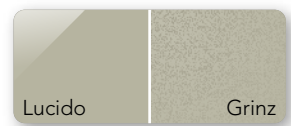

RAL 7032

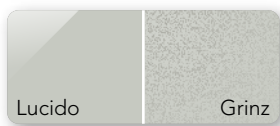

RAL 7035

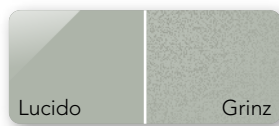

RAL 7038

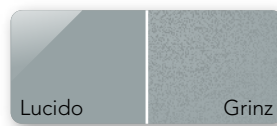

RAL 7040

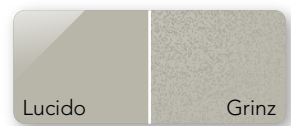

RAL 7044

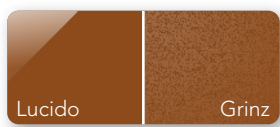

RAL 8003

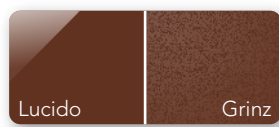

RAL 8011

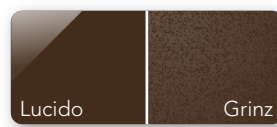

RAL 8014

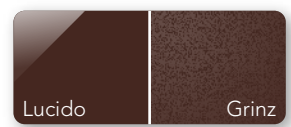

RAL 8017

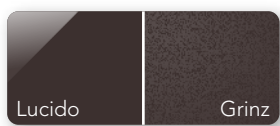

RAL 8019

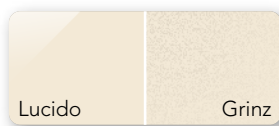

RAL 9001

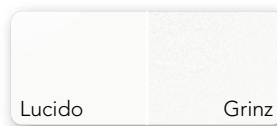

RAL 9003

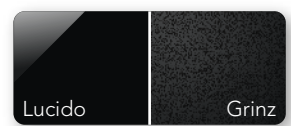

RAL 9005

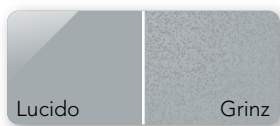

RAL 9006

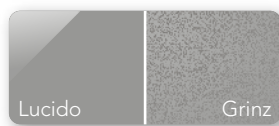

RAL 9007

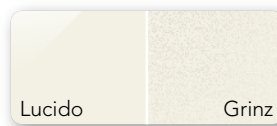

RAL 9010

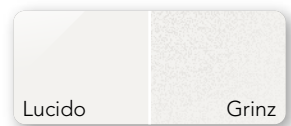

RAL 9016

INFINITY

STYLE

A FILO

EMOTION

NOVECENTO

INCYSO

VETRI E DECORI

MANIGLIE

PENSILINE

**COLORI**

SEZ. TECNICA



# EXCLUSIVE

## LACCATI SPECIALI

---

Il mondo dell'architettura è costantemente alla ricerca di nuove soluzioni. Con Exclusive proponiamo una selezione di finiture speciali che esaltano la materia e rendono le superfici morbide alla vista e ruvide al tatto.

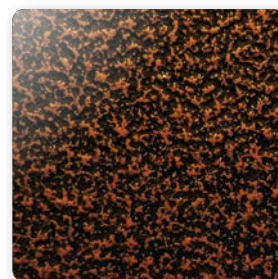

Rame bugnato AK02V



Grigio P7000 Mix



Verde P7100 Mix



Marrone P7200 Mix



Rosso P7300 Mix



Melon AK37V Grinz



Orange AK38V Grinz



Porpora AK39V Grinz

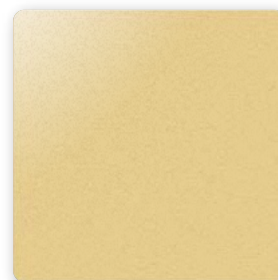

Avorio AK16V Grinz



Ambra AK40V Grinz



Bronzo TR03V Grinz



Antracite P016V Grinz

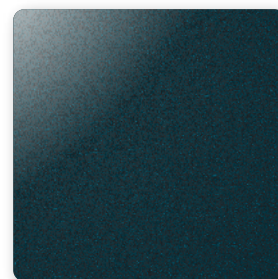

Bleu AK15V Grinz



Bianco P7503 Grinz Mix



Beige AK12V Grinz Mix



Grigio P7003 Grinz Mix

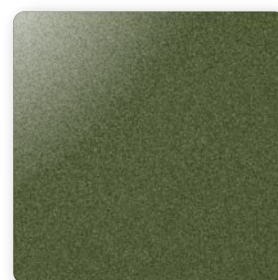

Salvia AK11V Grinz Mix



Verde P7103 Grinz Mix



Corten AK10V Grinz Mix



Corten V001V Grinz Mix

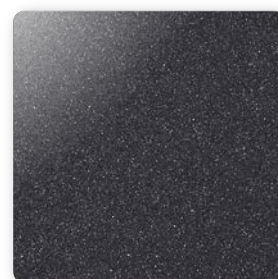

Marrone P7203 Grinz Mix

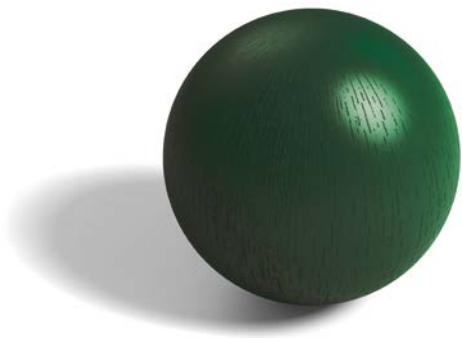

# SKIN

## PELLICOLATI

Finiture realizzate con pellicole decorative applicate tramite laminazione a freddo, direttamente sulle lastre di alluminio.

- Utilizziamo esclusivamente film decorativi Renolit e Hornschuch, i due maggiori produttori al mondo di pellicole acriliche per esterno, sinonimo di garanzia e qualità nel tempo.
- Oltre alla selezione di pellicole presenti in cartella, alle medesime condizioni, sono disponibili tutte le finiture indicate nella tabella sottostante. Per ulteriori esigenze, indicare marca e codice della finitura, sarà nostra cura comunicarne l'eventuale disponibilità e condizioni di fornitura.

Codici Hornschuch		Codici Renolit
Weiss F4361809 (*)	Walnuss Kolonial F4363062	Sapeli 2065 021-167
Macoree F4362001	Newcastle Oak Khaki F4363077	Sherwood G 49 158-011
Sapeli F4362002	Maigrüen F4365016	Sherwood W 49 201-011
Montana Eiche Tabak F4362007	Pastellgrüen F4365020	Siena PR 49 233-148
Staufereiche Terra F4362035	Tannengrüen F4365021	Siena PN 49 237-148
Staufereiche Kolonial F4362036	Beige F4565015 (*)	Dunkelgrün 11.61.09-179
Staufereiche Mocca F4362048	Altweiss F4565053	Moosgrün 6005 11.61.13-167
Eiche Mocca F4362075	Crème 4565054	Noce Gold 2178008-167
Eiche Kolonial F4362076	Brillantweiss F4565057	

(\*) Per queste finiture e quelle su richiesta, non sono disponibili le cornici per i pannelli a vetro ed i gocciolatoi. Consigliamo pertanto di abbinare a queste finiture, le cornici e/o i gocciolatoi in finitura effetto inox.





Weiss  
915205-168

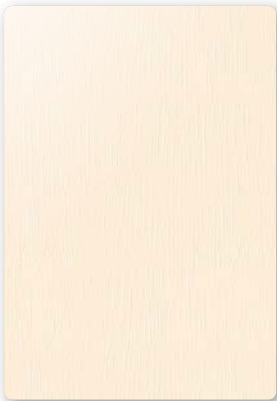

Cremeweiss  
1379 20.11.01-167



Dunkelgrun  
6125 11.61.09-167



Sheffield Oak Light  
F4563081



Siena  
PL 49 254-148



Winchester  
XA 49 240-148



Eiche Hell  
2052 090-167



Golden Oak  
2178 001-167



Nussbaum  
V 2178 007-167



Eiche Rustikal  
1 3149 008-167



Eiche Dunkel  
FL-F1 2052 089-167



Mahagoni  
2097 013-167



Black Cherry  
3202 001-167

Le venature del legno sono disposte in senso verticale rispetto al pannello



# EFFECT

## SUBLIMATI

---

L'alluminio sublimato, grazie alle migliori tecnologie e alla costante innovazione, riesce a trasmettere emozioni estetiche che superano spesso la bellezza dei materiali naturali che tende ad imitare.

Oltre alla gamma di finiture di nostra produzione presenti in questa cartella e sempre disponibili in pronta consegna, su richiesta, possiamo realizzare tali finiture direttamente presso le maggiori aziende presenti sul mercato indicate dal cliente. Ricordiamo che questo tipo di finiture spesso presentano differenze di tonalità che possono dipendere da diversi lotti di produzione, ma anche dall'applicazione su leghe diverse tra laminati ed estrusi: pertanto, queste particolari colorazioni sono da considerarsi realizzazioni uniche, irripetibili e incontestabili.



Corten RP101M



Ghisa RP102M



Cemento RP103M



Abete bianco RP14L



Rovere grigio RP10L



Ciliegio PVC - RP04L



Noce PVC - RP06L



Ciliegio chiaro RP03L



Ciliegio scuro RP02L



Castagno RP01L



Noce chiaro RP08L



Noce medio RP07L



Noce scuro RP05L

Le venature del legno sono disposte in senso verticale rispetto al pannello

# SEZIONI E SPESSORI

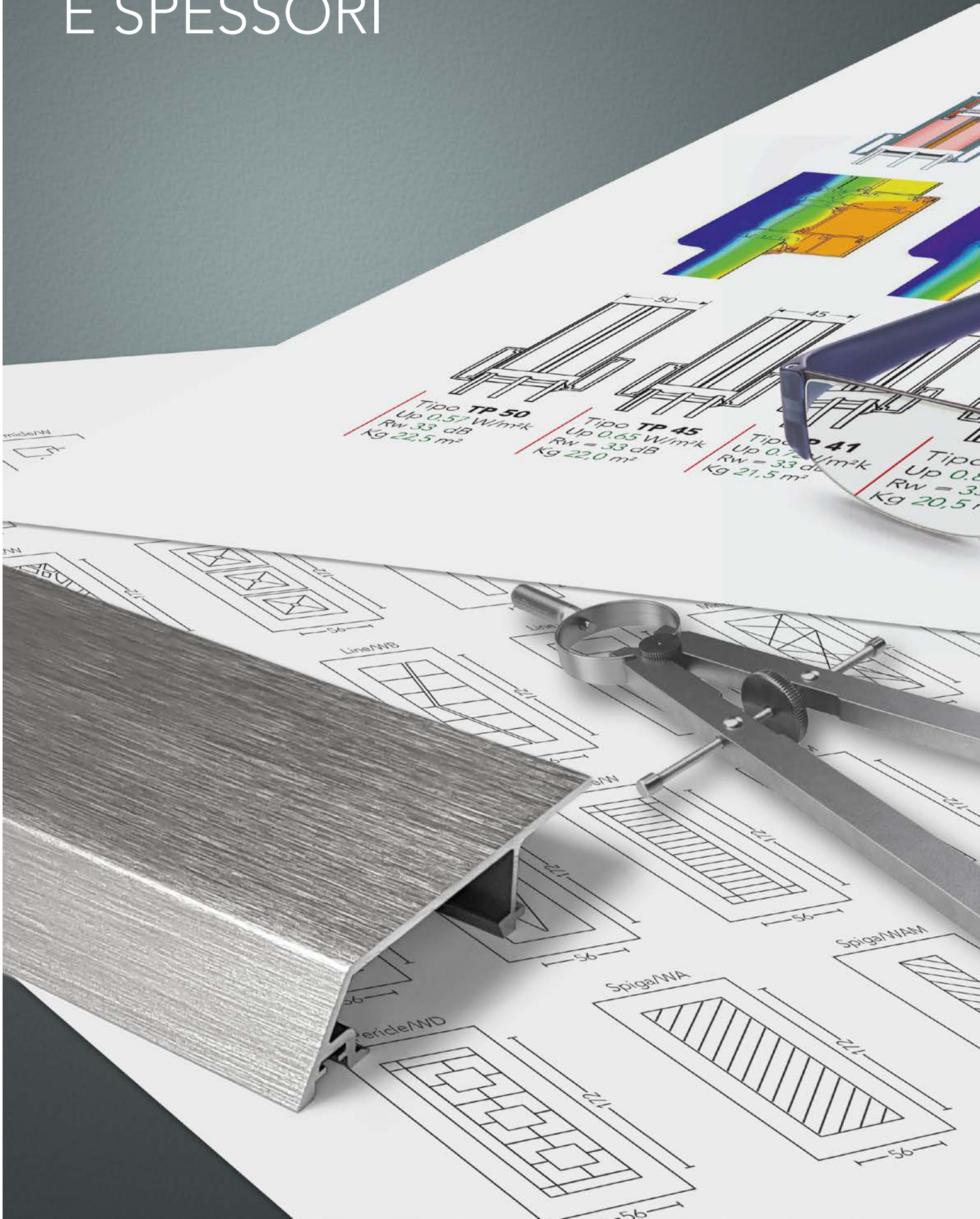



## SEZIONI E SPESSORI

PAG. 524

## PRODOTTI COMPLEMENTARI

PAG. 534

## MODULI ORDINE

PAG. 538



INFINITY

STYLE

A FILO

EMOTION

NOVECENTO

INCISO

VETRI E DECORI

MANIGLIE

PENSILINE

COLORI

SEZ. E SPESSORI

# SEZIONI

E SPESSORI

## MIGLIORAMENTO CONTINUO

DELLA FORMA E SOPRATTUTTO DELLA SOSTANZA

GARANZIA  
**20**  
ANNI

Aluform è da sempre sinonimo di soluzioni tecniche innovative. Dal primo pannello con isolante termico idrofugo in "PIRALL", a quello con barriera antirumore, fino al pannello con Giunto Elastico, un brevetto Aluform che riduce l'effetto "imbarcamento" dovuto alle dilatazioni termiche. Da quasi trent'anni, i prodotti Aluform si distinguono per qualità, affidabilità e capacità di proporre sempre soluzioni tecniche all'avanguardia in continua evoluzione. Per soddisfare le crescenti esigenze di un maggiore comfort abitativo e sicurezza, Aluform ha creato una nuova generazione di prodotti: fino a 9 strati di materiali innovativi dalle eccellenti qualità specifiche per garantire, in pochi millimetri di spessore, prestazioni termiche, acustiche, di robustezza e durata, sino ad oggi impensabili.

I pannelli Aluform sono testati, certificati e garantiti 20 anni contro il deterioramento dovuto ad eventuali infiltrazioni di umidità all'interno del nucleo. Ma la miglior testimonianza della qualità dei nostri prodotti sono gli oltre mezzo milione di pannelli Aluform che, dopo decenni di esposizione alle insidie del tempo, hanno mantenuto inalterata la loro bellezza e, soprattutto, la loro funzionalità.



BARRIERA ANTI RUMORE IN ELASTOMERO

+ **ABBATTIMENTO ACUSTICO**



GIUNTO ELASTICO VISCOSO IN NEOPRENE

+ **STABILITÀ ALLA DILATAZIONE TERMICA LINEARE**



LASTRE IN PIRALL® AD ELEVATO POTERE ISOLANTE

+ **ISOLAMENTO TERMICO**



LASTRA IN ERGAL

+ **ROBUSTEZZA AI TENTATIVI DI INTRUSIONE**



LASTRE IN ALLUMINIO SUPPORTATE

+ **PLANARITÀ E TENUTA DELLE VITI**



TRATTAMENTO DI VERNICIATURA A TRIPLO STRATO

+ **RESISTENZA A SALSINEDINE E CORROSIONE**



CORNICE INTERNA REMOVIBILE

**POSSIBILITÀ DI SOSTITUIRE I VETRI**

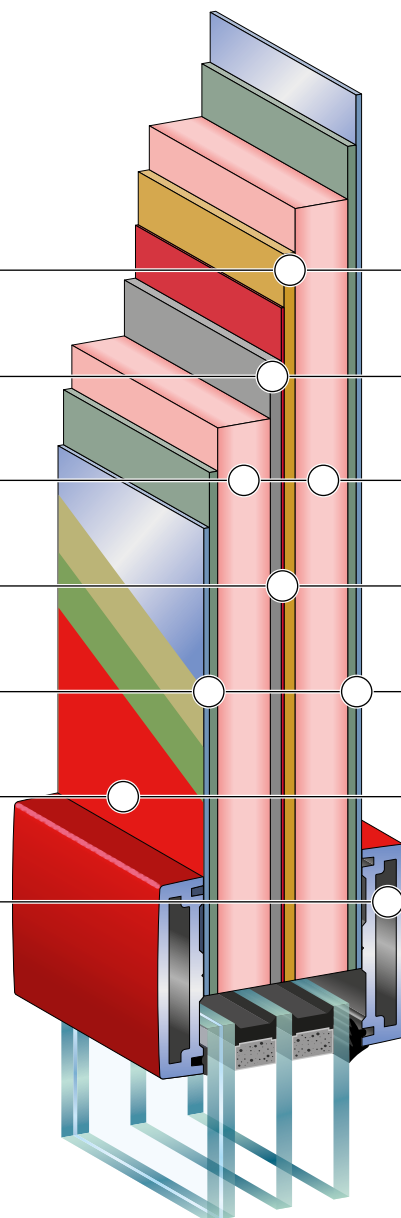

# LA GAMMA DI SOLUZIONI PIU' COMPLETA

PER PORTE DI OGNI GENERE

## EVO

SISTEMA ANTA A SCOMPARSA

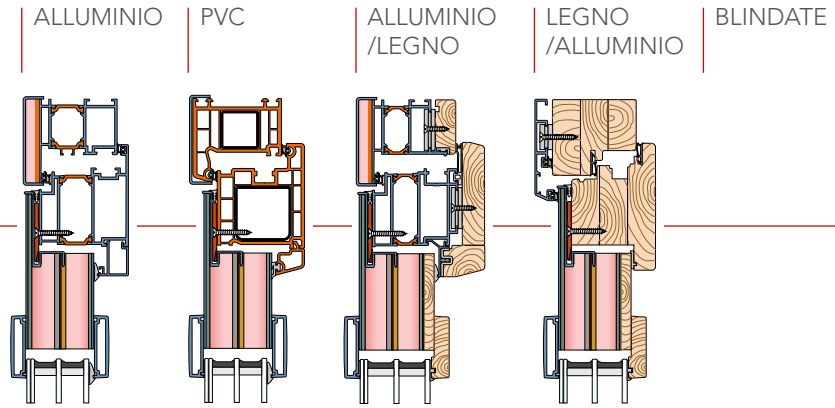

## TOP

SISTEMA STRUTTURALE

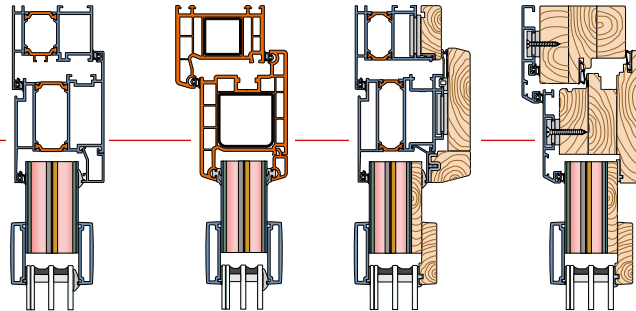

## PLUS

SISTEMA UNIVERSALE

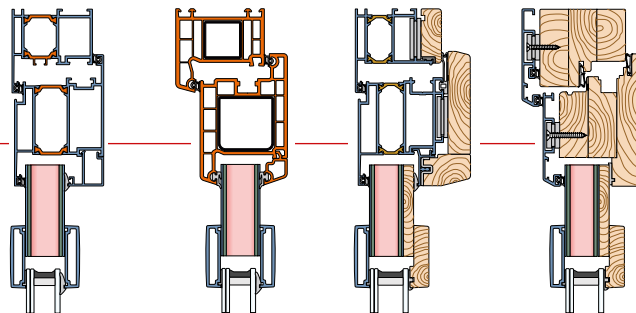

## KOVER

SISTEMA DI RIVESTIMENTO  
PER PORTE BLINDATE

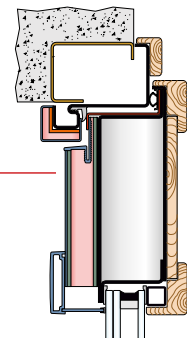

La stratigrafia e le caratteristiche dei pannelli, variano in funzione dello spessore e della tipologia. I valori di trasmittanza termica, abbattimento acustico, e peso indicati nelle rispettive tipologie si riferiscono al pannello cieco.

INFINITY

STYLE

A FILO

EMOTION

NOVECENTO

INCYSO

VETRI E DECORI

MANIGLIE

PENSILINE

COLORI

SEZ. TECNICA

# EVO

SISTEMA ANTA A SCOMPARSA  
PER PORTE IN ALLUMINIO E PVC



ALLUMINIO

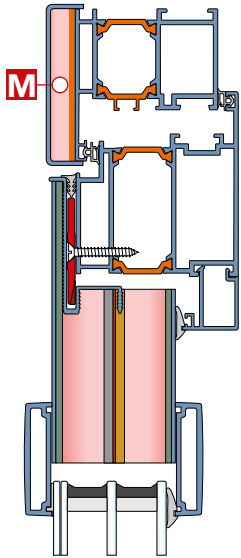

PVC

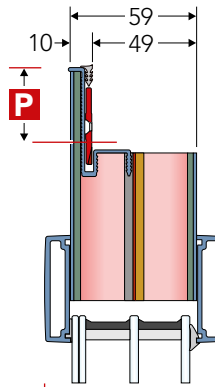
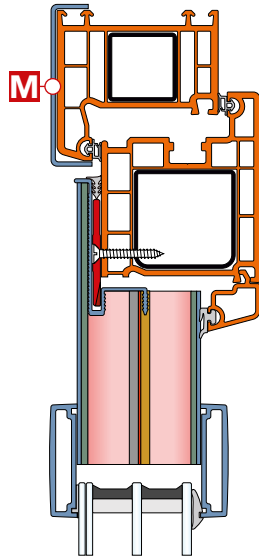

Tipo **EV 59**  
Up 0.47 W/m<sup>2</sup>k  
Rw 33 dB  
Kg 22,5 m<sup>2</sup>

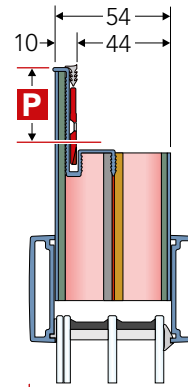

Tipo **EV 54**  
Up 0.52 W/m<sup>2</sup>k  
Rw 33 dB  
Kg 22,0 m<sup>2</sup>

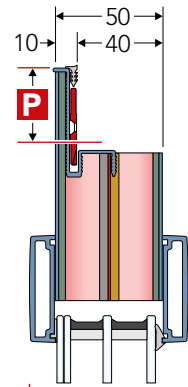

Tipo **EV 50**  
Up 0.57 W/m<sup>2</sup>k  
Rw 33 dB  
Kg 21,5 m<sup>2</sup>

# EVO-MIX

SISTEMA ANTA A SCOMPARSA  
PER PORTE INTERNO LEGNO



ALLUM./LEGNO

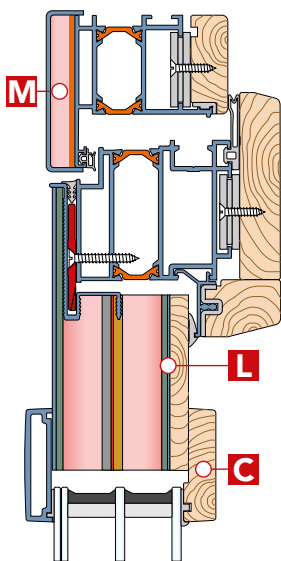

LEGNO/ALLUM.

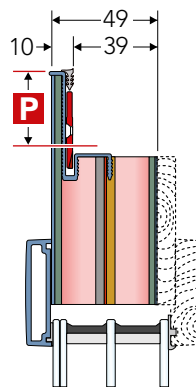
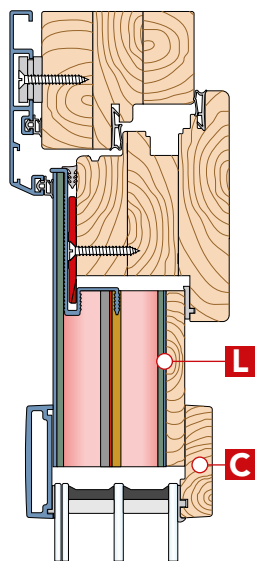

Tipo **EM 49**  
Up 0.57 W/m<sup>2</sup>k  
Rw 33 dB  
Kg 19,5 m<sup>2</sup>

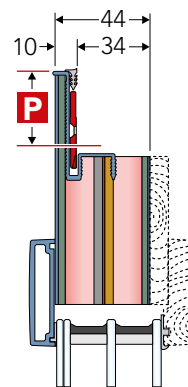

Tipo **EM 44**  
Up 0.65 W/m<sup>2</sup>k  
Rw 33 dB  
Kg 19,0 m<sup>2</sup>

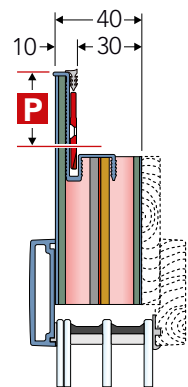

Tipo **EM 40**  
Up 0.73 W/m<sup>2</sup>k  
Rw 33 dB  
Kg 18,5 m<sup>2</sup>

**C:** cornice lato interno su richiesta, realizzabile in alluminio in tutte le finiture. **L:** lato in alluminio in finitura Primer (non verniciato) **M:** mostrine di rivestimento per telaio lato esterno. **P:** quota di sormonto del pannello da indicare nell'ordine.



## DIMENSIONI DEI PANNELLI

- Formato **standard** cm: **90 x 215**  
(mezza anta cm: 45 x 215).
- **Altri formati** cm:  
110 x 230, 110 x 250, 125 x 250  
(mezza anta cm: 55 x 230, 55 x 250).

### Pannelli da ordinare su misura.

## ISTRUZIONI PER L'ORDINE

Prima di compilare l'ordine, da inoltrare mediante l'apposito modulo, consultare anche le caratteristiche e le limitazioni tecniche specifiche di ciascuna collezione.

Indicare nell'ordine la misura finita del pannello e la quota (**P**) riferita al sormonto del pannello sul profilo dell'anta (vedi disegno a fianco). Per sfruttare la reversibilità consentita dalla maggior parte dei modelli, la lavorazione perimetrale (con il bordo in finitura argento) è sempre realizzata della stessa misura sui 4 lati del pannello. Nella parte inferiore dell'anta si consiglia di applicare il gocciolatoio.

Eventuali **accessori e componenti** da ordinare insieme al pannello:

- Mostrine per telaio (**M**) e/o gocciolatoio (vedi capitolo componenti alle pagine successive).
- Cornici in alluminio (**C**) per pannelli Evo-Mix, indicando nell'ordine la quota X;
- Vetri;
- Maniglie e accessori di chiusura.

## LAVORAZIONI E ASSEMBLAGGIO

Per realizzare porte con anta a scomparsa con profili tradizionali, che non adottano il sistema Aluform, e' sufficiente asportare l'aletta di battuta del vetro (vedi immagine sotto) ed utilizzare il sistema di fissaggio brevettato, fornito in dotazione con il pannello. Un sistema pratico e veloce che non richiede l'utilizzo di profili di riporto, colle, adesivi o viti in vista. Inoltre, il pannello può essere "caricato" come un vetro, smontato e rimontato o sostituito in qualsiasi momento.

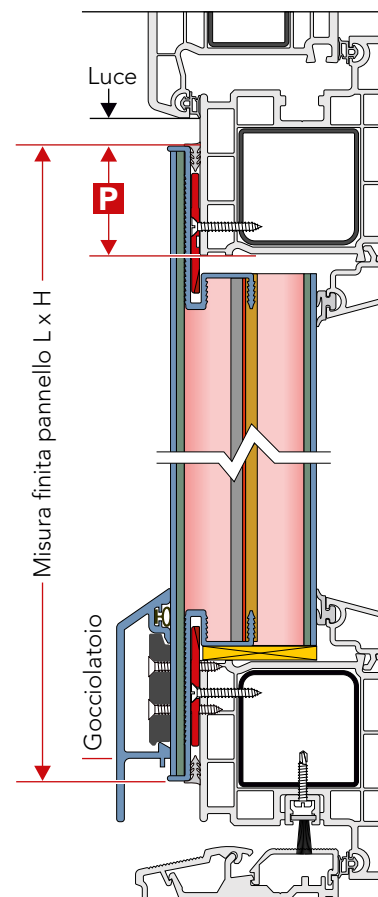
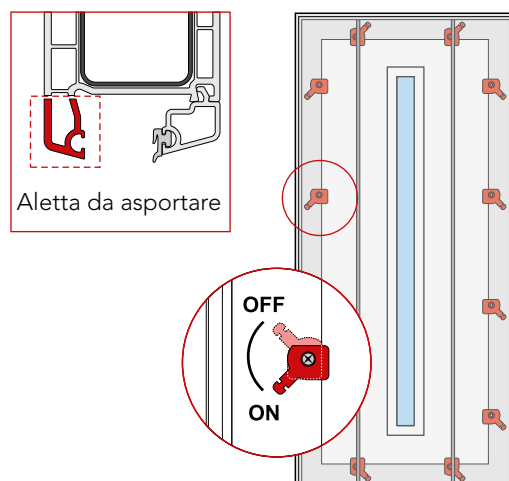

Cornice lato interno per pannelli Evo-Mix. **Su richiesta.**

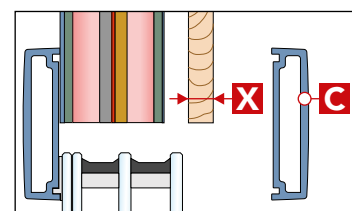

Mostrine per rivestimento telaio lato esterno. **Su richiesta.**

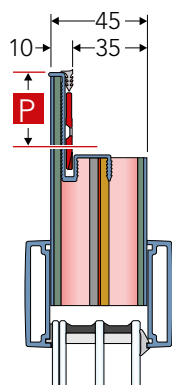

### Tipo **EV 45**

Up 0.65 W/m<sup>2</sup>k  
Rw 33 dB  
Kg 21,0 m<sup>2</sup>

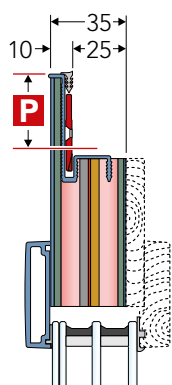

### Tipo **EM 35**

Up 0.86 W/m<sup>2</sup>k  
Rw 33 dB  
Kg 18,0 m<sup>2</sup>

# TOP

SISTEMA STRUTTURALE  
PER PORTE IN ALLUMINIO E PVC



ALLUMINIO

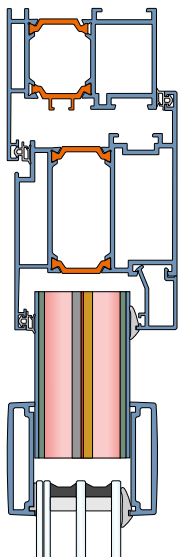

PVC

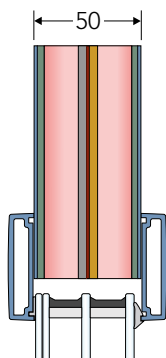
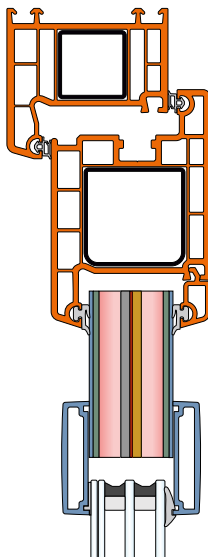

Tipo **TP 50**  
Up 0.57 W/m<sup>2</sup>k  
Rw 33 dB  
Kg 21,5 m<sup>2</sup>

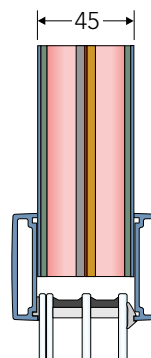

Tipo **TP 45**  
Up 0.65 W/m<sup>2</sup>k  
Rw 33 dB  
Kg 21,0 m<sup>2</sup>

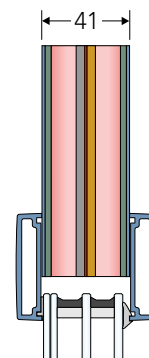

Tipo **TP 41**  
Up 0.73 W/m<sup>2</sup>k  
Rw 33 dB  
Kg 20,5 m<sup>2</sup>

# TOP-MIX

SISTEMA STRUTTURALE  
PER PORTE INTERNO LEGNO



ALLUM./LEGNO

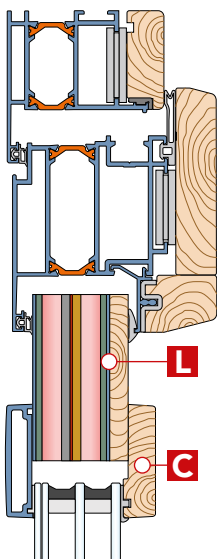

LEGNO/ALLUM.

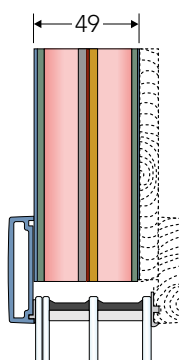
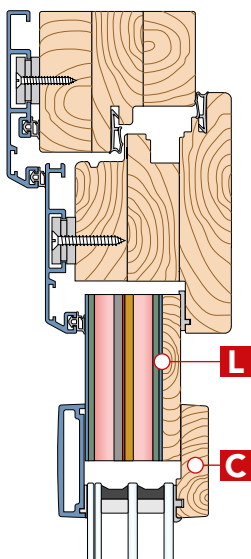

Tipo **TM 49**  
Up 0.57 W/m<sup>2</sup>k  
Rw 33 dB  
Kg 19,5 m<sup>2</sup>

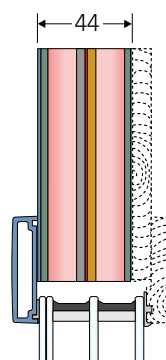

Tipo **TM 44**  
Up 0.65 W/m<sup>2</sup>k  
Rw 33 dB  
Kg 19,0 m<sup>2</sup>

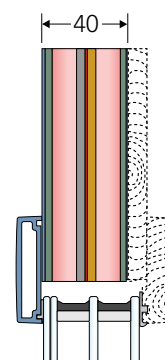

Tipo **TM 40**  
Up 0.73 W/m<sup>2</sup>k  
Rw 33 dB  
Kg 18,5 m<sup>2</sup>

**C**: cornice lato interno su richiesta, realizzabile in alluminio in tutte le finiture. **L**: lato in alluminio in finitura Primer (non verniciato) **M**: mostrine di rivestimento per telaio lato esterno. **P**: quota di sormonto del pannello da indicare nell'ordine.

## DIMENSIONI DEI PANNELLI

- Formato **standard** cm: **90 x 215**  
(mezza anta cm: 45 x 215).
- Formati **su richiesta** cm:  
110 x 230, 110 x 250, 125 x 250  
(mezza anta cm: 55 x 230, 55 x 250).
- Taglio a misura: **su richiesta**

## ISTRUZIONI PER L'ORDINE

Prima di compilare l'ordine, da inoltrare mediante l'apposito modulo, consultare anche le caratteristiche e le limitazioni tecniche specifiche di ciascuna collezione.

Il pannello viene fornito di serie nella misura standard: formati diversi e taglio a misura, su richiesta.

Eventuali **accessori e componenti** da ordinare insieme al pannello:

- Cornici in alluminio (**C**) per pannelli Top-Mix, indicando nell'ordine la quota X;
- Vetri;
- Maniglie e accessori di chiusura.

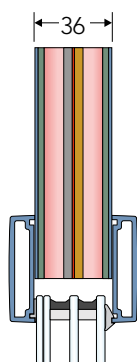

Tipo **TP 36**  
Up 0.86 W/m<sup>2</sup>k  
Rw 33 dB  
Kg 20,0 m<sup>2</sup>

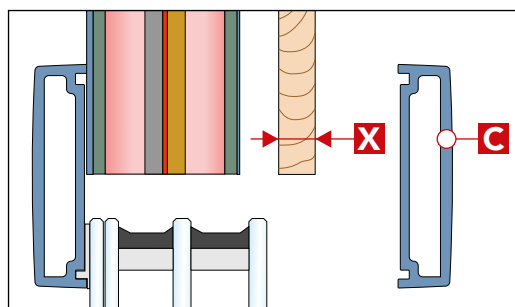

Cornice lato interno per pannelli Top-Mix.  
**Su richiesta**

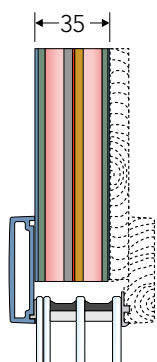

Tipo **TM 35**  
Up 0.86 W/m<sup>2</sup>k  
Rw 33 dB  
Kg 18,0 m<sup>2</sup>

# PLUS

SISTEMA UNIVERSALE  
PER PORTE IN ALLUMINIO E PVC



ALLUMINIO

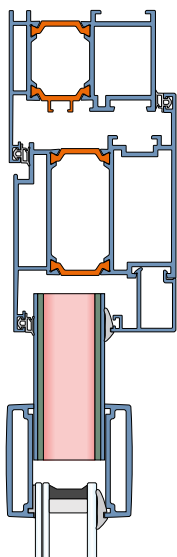

PVC

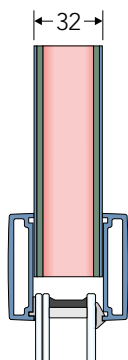
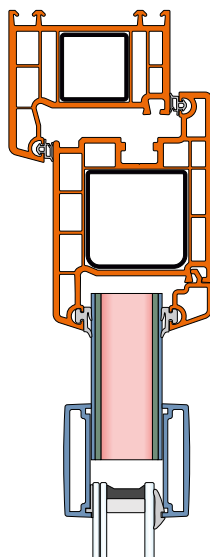

Tipo **PL 32**  
Up 0.81 W/m<sup>2</sup>k  
Kg 13,5 m<sup>2</sup>

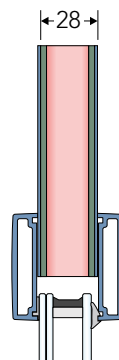

Tipo **PL 28**  
Up 0.98 W/m<sup>2</sup>k  
Kg 13,0 m<sup>2</sup>

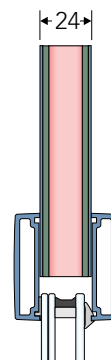

Tipo **PL 24**  
Up 1.2 W/m<sup>2</sup>k  
Kg 12,5 m<sup>2</sup>

# PLUS-MIX

SISTEMA UNIVERSALE  
PER PORTE INTERNO LEGNO



ALLUM./LEGNO

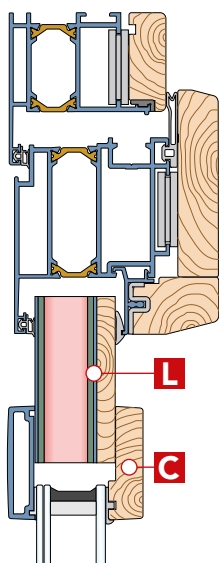

LEGNO/ALLUM.

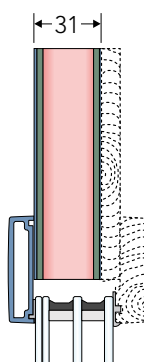
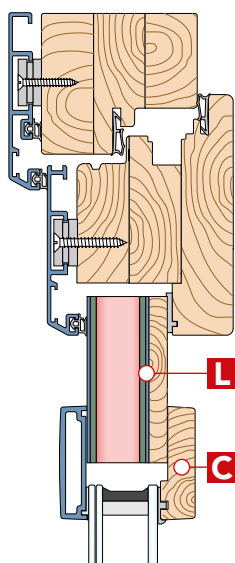

Tipo **PM 31**  
Up 0.81 W/m<sup>2</sup>k  
Kg 11,5 m<sup>2</sup>

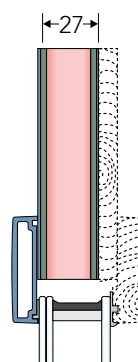

Tipo **PM 27**  
Up 0.98 W/m<sup>2</sup>k  
Kg 11,0 m<sup>2</sup>

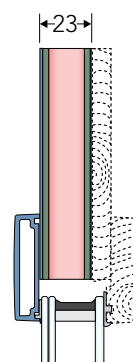

Tipo **PM 23**  
Up 1.2 W/m<sup>2</sup>k  
Kg 10,5 m<sup>2</sup>

**C:** cornice lato interno su richiesta, realizzabile in alluminio in tutte le finiture. **L:** lato in alluminio in finitura Primer (non verniciato) **M:** mostrine di rivestimento per telaio lato esterno. **P:** quota di sormonto del pannello da indicare nell'ordine.

## DIMENSIONI DEI PANNELLI

- Formato **standard** cm: **90 x 215**  
(mezza anta cm: 45 x 215).
- Formati **su richiesta** cm:  
110 x 230, 110 x 250, 125 x 250  
(mezza anta cm: 55 x 230, 55 x 250).
- Taglio a misura: **su richiesta**

## ISTRUZIONI PER L'ORDINE

Prima di compilare l'ordine, da inoltrare mediante l'apposito modulo, consultare anche le caratteristiche e le limitazioni tecniche specifiche di ciascuna collezione.

Il pannello viene fornito di serie nella misura standard: formati diversi e taglio a misura, su richiesta.

Eventuali **accessori e componenti** da ordinare insieme al pannello:

- Cornici in alluminio (**C**) per pannelli Plus-Mix, indicando nell'ordine la quota X;
- Vetri;
- Maniglie e accessori di chiusura.

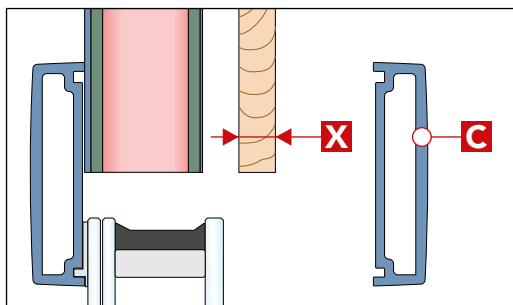

Cornice lato interno per pannelli Plus-Mix.  
**Su richiesta.**

# KOVER-EXTRATHERM

SISTEMA DI RIVESTIMENTO  
PER PORTE BLINDATE

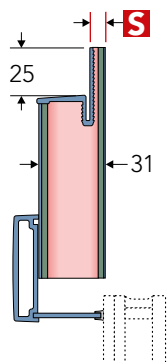
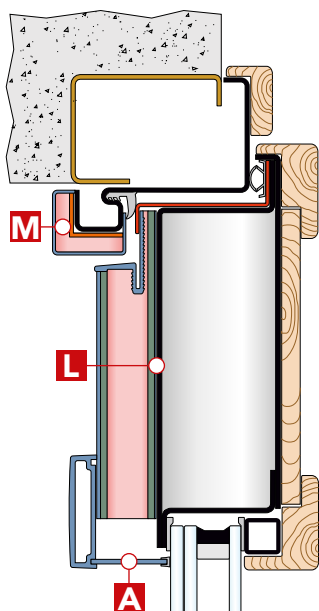

Tipo **KE 31**  
Up 0.81 W/m<sup>2</sup>k  
Kg 11,5 m<sup>2</sup>

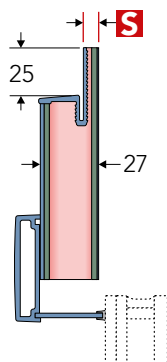

Tipo **KE 27**  
Up 0.98 W/m<sup>2</sup>k  
Kg 11,0 m<sup>2</sup>

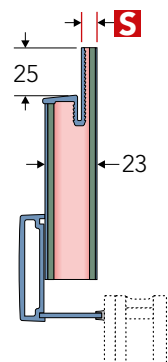

Tipo **KE 23**  
Up 1.2 W/m<sup>2</sup>k  
Kg 10,5 m<sup>2</sup>

# KOVER

SISTEMA DI RIVESTIMENTO  
PER PORTE BLINDATE

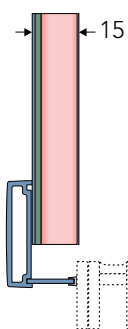
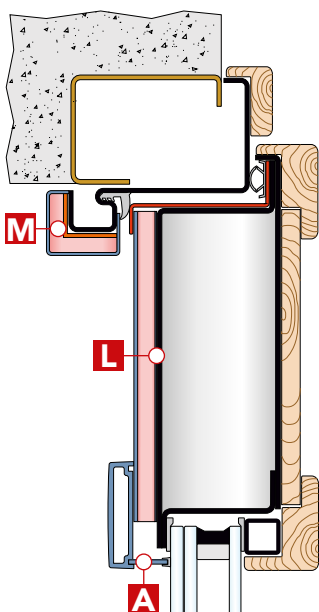

Tipo **KV 15**  
Up 1.6 W/m<sup>2</sup>k  
Kg 8,0 m<sup>2</sup>

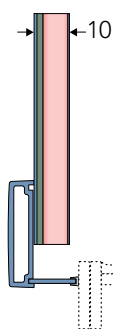

Tipo **KV 10**  
Up 2.9 W/m<sup>2</sup>k  
Kg 7,5 m<sup>2</sup>

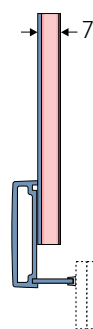

Tipo **KV 7**  
Up 3.1 W/m<sup>2</sup>k  
Kg 5,0 m<sup>2</sup>

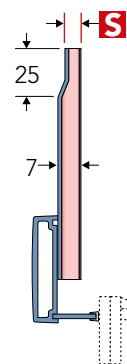

Tipo **KR 7**  
Up 3.1 W/m<sup>2</sup>k  
Kg 5,0 m<sup>2</sup>

**A:** aletta cingivetro (consigliata). **L:** lato in alluminio in finitura Primer (non verniciato) **M:** mostrine di rivestimento per telaio lato esterno. **S:** spessore del bordo ribassato da indicare nell'ordine.

## DIMENSIONI DEI PANNELLI

- Formato **standard** cm: **95 x 215**  
(mezza anta cm: 45 x 215).

- Formati **su richiesta** cm:  
110 x 230, 110 x 250, 125 x 250  
(mezza anta cm: 55 x 230, 55 x 250).

-Taglio a misura:

**di serie** per le tipologie con bordo ribassato;  
**su richiesta** per le tipologie a spessore uniforme.

## ISTRUZIONI PER L'ORDINE

Prima di compilare l'ordine, da inoltrare mediante l'apposito modulo, consultare anche le caratteristiche e le limitazioni tecniche specifiche di ciascuna collezione.

Per le **tipologie con bordo ribassato**, indicare nell'ordine la misura finita del pannello. Per sfruttare la reversibilità consentita dalla maggior parte dei modelli, la lavorazione perimetrale (con il bordo in finitura argento) è sempre realizzata della stessa misura sui 4 lati del pannello. Nella parte inferiore dell'anta si consiglia di applicare il gocciolatoio.

Per le **tipologie a spessore uniforme**, il pannello viene fornito di serie nella misura standard, formati diversi e taglio a misura, su richiesta. Nei modelli a vetri, per una migliore rifinitura perimetrale del vetro sul lato esterno, consigliamo di richiedere l'aletta cingivetro (**A**). In fase di ordine, comunicare la quota (**X**) come indicato nel disegno a fianco.

Eventuali **accessori e componenti** da ordinare insieme al pannello:

- Mostrine per telaio (**M**), gocciolatoio, coprifili, ecc. (vedi capitolo componenti alle pagine successive);

- Maniglie e accessori di chiusura.

## Note:

- Per le collezioni **Infinity** e **A Filo**, lo spessore minimo realizzabile del bordo ribassato della sezione Tipo **KR 7** è di 6 millimetri.

- Per le collezioni **Infinity** e **Style**, l'aletta cingivetro non è realizzabile. Una possibile soluzione per la rifinitura perimetrale del vetro sul lato esterno, è di adattare una guarnizione commerciale in gomma. Oppure ordinare il pannello completo di vetro satinato temprato spessore 4 mm, da anteporre al vetro della porta (vedi disegno a fianco).

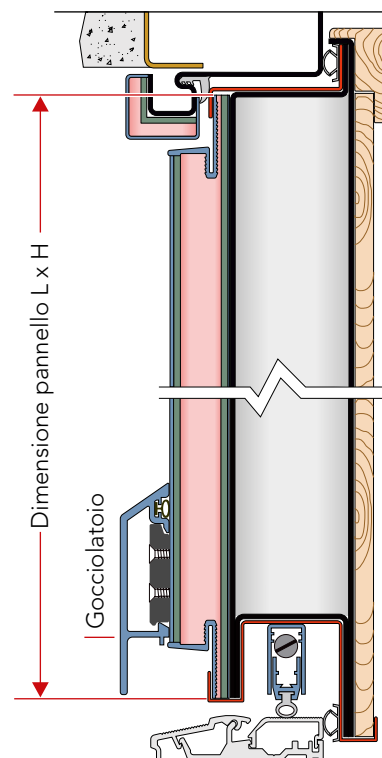

Particolare aletta cingivetro su pannelli a vetri delle collezioni **A Filo** e **Emotion**.

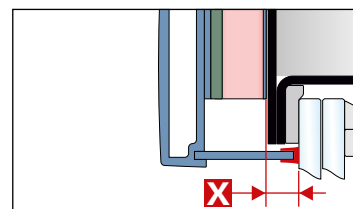

Particolare aletta cingivetro su pannelli a vetri della collezione **Novecento**.

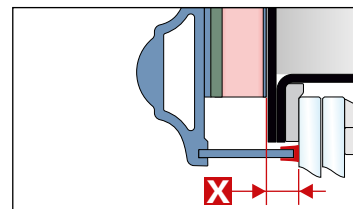

Particolare vetro satinato temprato sp. 4 mm, inserito su pannelli a vetri delle collezioni **Infinity** e **Style**.

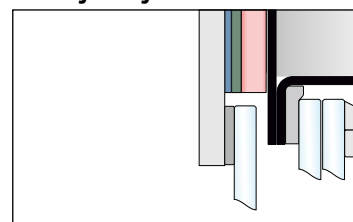

# COMPONENTI

## PER PORTE BLINDATE IN **TOTAL LOOK**

Una serie di componenti su misura e finiture in **Total Look** per rendere ancora più esclusiva e unica la porta d'ingresso. Aluform è l'ingresso dal design ricercato, completo e funzionale per chi non rinuncia alla qualità.

PORTA BLINDATA  
TRADIZIONALE



PORTA BLINDATA  
IN **TOTAL LOOK**

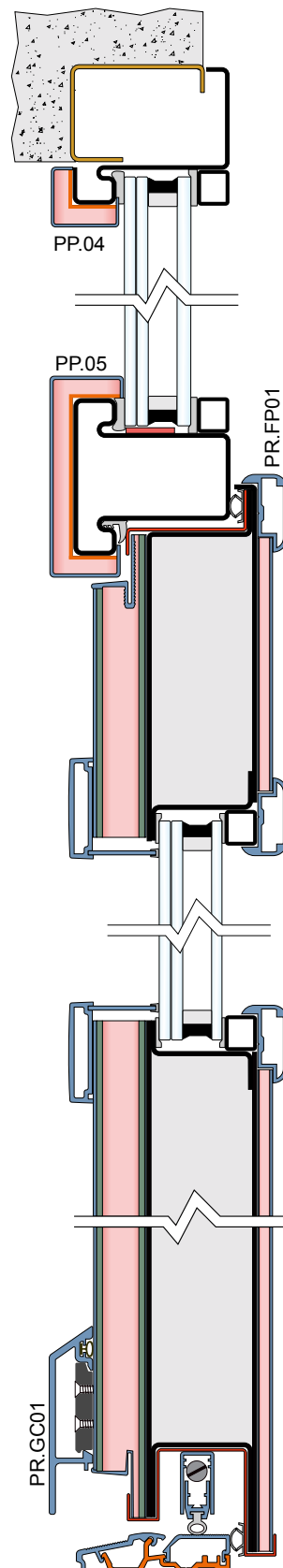

BATTUTA PORTE A DUE ANTE

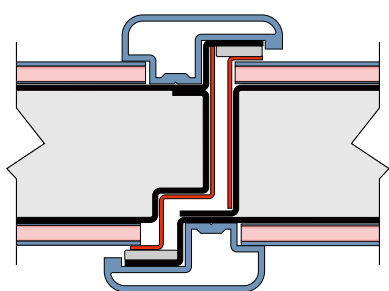

### Soluzione A

Profilo in alluminio estruso disponibile in due differenti sagome, adattabile alle maggiori marche di porte blindate.

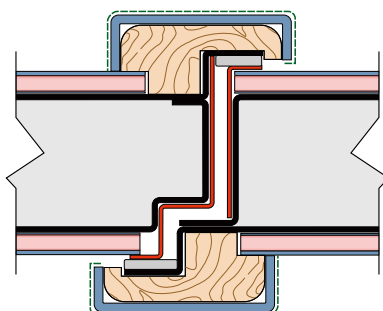

### Soluzione B

Profilo in alluminio pressopiegato (Art. PP.03) realizzato su misura da utilizzare come cover della battuta in legno standard.



## PROFILI IN ALLUMINIO ESTRUSO

PER BATTUTE PORTE DUE ANTE, APERTURE ESTERNE E GOCCIOLATOI

### Art. PR.BT01

Battuta per due ante (completo di tappi)

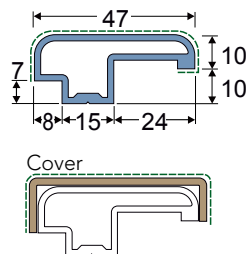

### Art. PR.BT03

Battuta per due ante

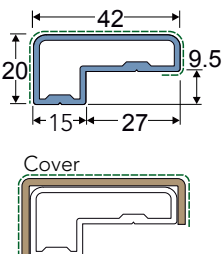

### Art. PR.FP01

Kit fermapannello apertura esterna (completo di tappi)

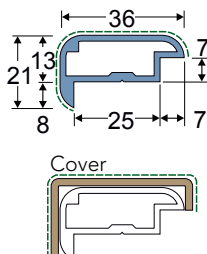

### Art. PR.GC01

Gocciolatoio (completo di tappi e fissaggi)

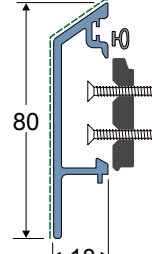

**IMPORTANTE!** I profili Art.: PR.BT01, PR.BT03 PR.FP01 nelle finiture effetto legno e Renolit, sono realizzati con cover di rivestimento

### LUNGHEZZA PROFILI

- Battute e kit fermapannello: di serie mm 2300. **Su richiesta:** maggiorata a mm 2500.
- Gocciolatoio: di serie mm 1100. **Su richiesta:** maggiorata a mm: 550 e 1250.

## PROFILI IN ALLUMINIO PRESSOPIEGATO

PER RIVESTIMENTO TELAI E COPRIFILO

Realizzati su misura di ogni forma e dimensione, in tutte le finiture della cartella Aluform, disponibili nella versione in alluminio nudo o supportato con isolante termico. Una serie di componenti per rifinire e, soprattutto, ottenere un miglioramento della trasmittanza termica dei telai, riducendo significativamente il fenomeno di condensa all'interno della porta.

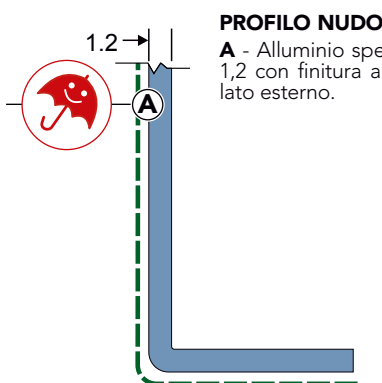

### PROFILO NUDO

**A** - Alluminio spessore mm 1,2 con finitura a scelta sul lato esterno.

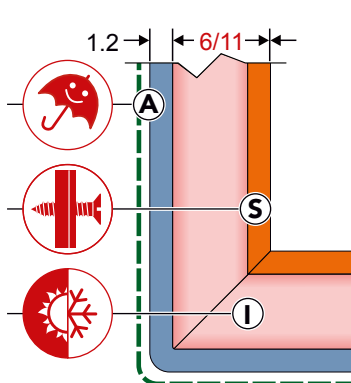

### PROFILO CON ISOLANTE TERMICO

**A** - Alluminio spessore mm 1,2 con finitura a scelta sul lato esterno.

**I** - Isolante termico in PIRALL spessore a scelta di mm 6 oppure mm 11.

**S** - Lastra in PVC supportato per favorire il fissaggio con viti o collanti.

### Valori di trasmittanza termica:

- Con isolamento di mm 6:  $U=3.0W/m^2k$
- Con isolamento di mm 11:  $U=1.7W/m^2k$

### Art. PP.01



### Art. PP.02

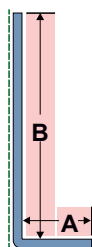

### Art. PP.03

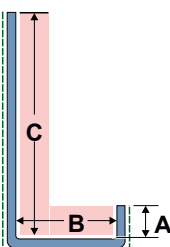

### Art. PP.04

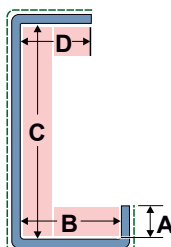

### Art. PP.05

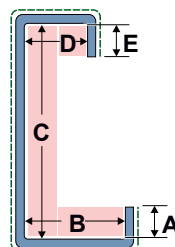

### IMPORTANTE!

- La misura minima della prima piega (quota A) non può essere inferiore a mm 4.
- Le misure indicate nell'ordine sono sempre riferite al lato interno del profilo, anche nella soluzione con isolamento termico.
- L'isolante termico, di 6 o 11 millimetri, viene applicato su richiesta nei lati del profilo indicati nell'ordine. E' possibile indicare spessori di isolamento diversi fra un lato e l'altro del profilo.
- Per eventuali sagome e tipologie di profili non previste, inviare disegno quotato.

### LUNGHEZZA PROFILI

- Di serie per le finiture laccate mm 2500, per le finiture effetto legno e renolit mm 2300.
- **Su richiesta:** per le finiture laccate maggiorata a mm 3000, per le finiture effetto legno e Renolit maggiorata a mm 2500.





Pannelli taylor made

# MINY

Per esprimere la tua personalità e dare alla tua casa uno stile unico anche su finestre, persiane e scuri, senza rinunciare alla sicurezza e all'affidabilità dei pannelli Aluform.

INFINITY

STYLE

A FILO

EMOTION

NOVECENTO

INCYSO

VETRI E DECORI

MANIGLIE

PENSILINE

COLORI

SEZ. TECNICA

# MINY

PANNELLI TAYLOR PER FINESTRE,  
PERSIANE, SCURI ESTERNI E INTERNI  
IN STILE CLASSICO E MODERNO

In stile classico, ispirato alla collezione Incyso, Infinity e A Filo, la collezione MINY è stata progettata per esprimere la tua personalità e dare alla tua casa uno stile unico, senza rinunciare alla sicurezza e all'affidabilità dei pannelli Aluform, anche nel resto degli infissi.



Finestre



Persiane



Scuri versione **TABLET**



Scuri versione **INCYSO**



Scuri versione **A FILO**



Scuri versione **INFINITY**

## ESEMPI DI UTILIZZO DEI PANNELLI **MINY**

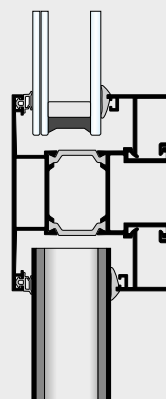

Sottotraversi  
di finestre in  
Alluminio e PVC

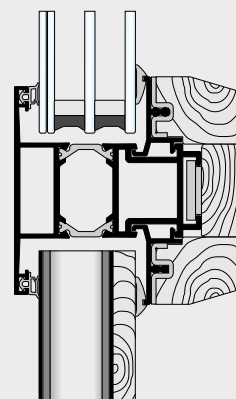

Sottotraversi  
di finestre  
interno Legno

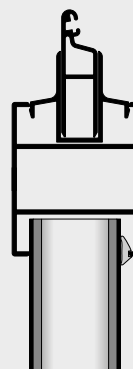

Sottotraversi  
di persiane

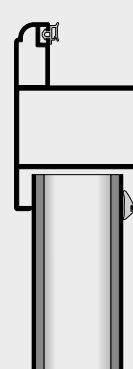

Scuri esterni con  
telaio a vista

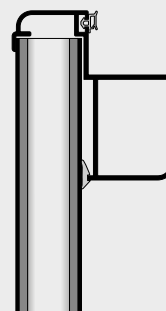

Scuri esterni con  
telaio a scomparsa



Scuretti interni

## PLUS

SISTEMA UNIVERSALE PER FINESTRE,  
SCURI E SCURETTI IN ALLUMINIO E PVC

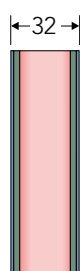

Tipo **PL 32**  
Up 0.81 W/m<sup>2</sup>k  
Kg 13,5 m<sup>2</sup>

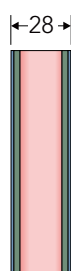

Tipo **PL 28**  
Up 0.98 W/m<sup>2</sup>k  
Kg 13,0 m<sup>2</sup>

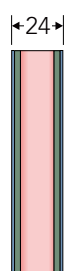

Tipo **PL 24**  
Up 1.2 W/m<sup>2</sup>k  
Kg 12,5 m<sup>2</sup>

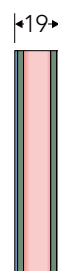

Tipo **PL 19**  
Up 1.6 W/m<sup>2</sup>k  
Kg 12,0 m<sup>2</sup>

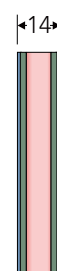

Tipo **PL 14**  
Up 2.7 W/m<sup>2</sup>k  
Kg 11,5 m<sup>2</sup>

## PLUS-MIX

SISTEMA UNIVERSALE PER FINESTRE  
INTERNO LEGNO

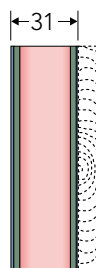

Tipo **PM 31**  
Up 0.81 W/m<sup>2</sup>k  
Kg 11,5 m<sup>2</sup>

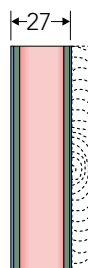

Tipo **PM 27**  
Up 0.98 W/m<sup>2</sup>k  
Kg 11,0 m<sup>2</sup>

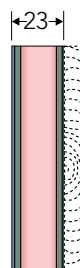

Tipo **PM 23**  
Up 1.2 W/m<sup>2</sup>k  
Kg 10,5 m<sup>2</sup>

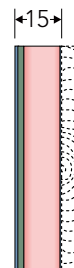

Tipo **KV 15**  
Up 1.6 W/m<sup>2</sup>k  
Kg 8,0 m<sup>2</sup>

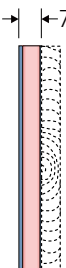

Tipo **KV 7**  
Up 3.1 W/m<sup>2</sup>k  
Kg 5,0 m<sup>2</sup>

# MINY VERSIONE MULTI

PANNELLI MULTIUSO PER FINESTRE E PERSIANE

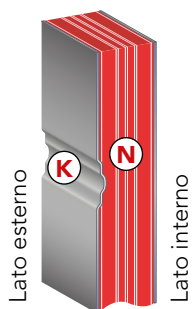

## CARATTERISTICHE

**K** - Lavorazione decorativa di mm 30 x 4 di profondità, ricavata sulla lastra di alluminio.

**I** - Lato interno liscio realizzato di serie dello stesso colore del lato esterno (o colore base per i modelli bicolore). **Su richiesta:** lato interno Double (stessa lavorazione del lato esterno) e colori diversi.

**N** - Nucleo costituito da un mix di materiali particolarmente performanti, disposti in più strati, con ottime proprietà di isolamento termico.

**Dimensioni:** realizzati di serie nei formati standard (vedere pagina a fianco) con lavorazioni decorative multiple a dimensioni fisse da sezionare in base alle esigenze. **Su richiesta:** pannelli nei formati standard con lavorazioni decorative multiple su misura.

**Sezioni e spessori:** Vedere a pag. 539.

**Limitazioni:** tutti i colori effetto legno e Renolit, hanno le venature disposte in senso verticale rispetto al pannello.

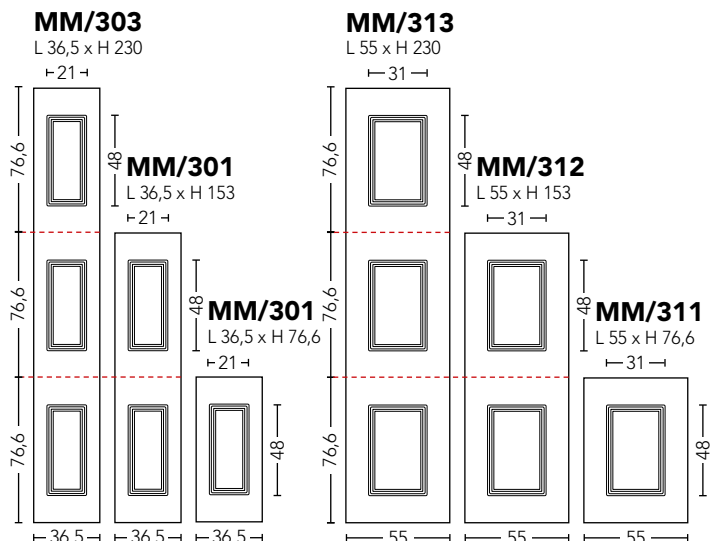
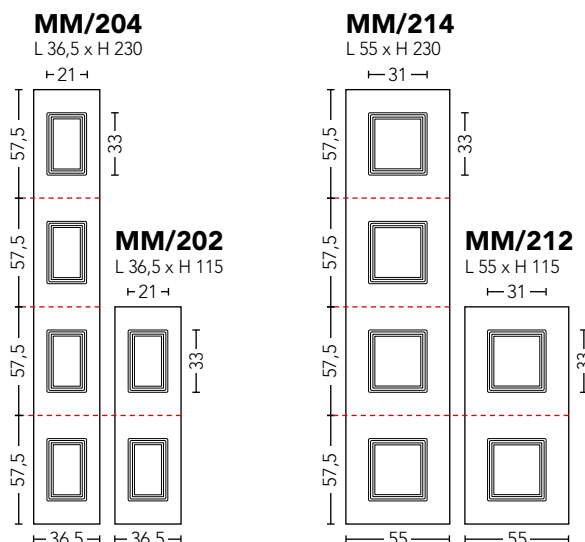
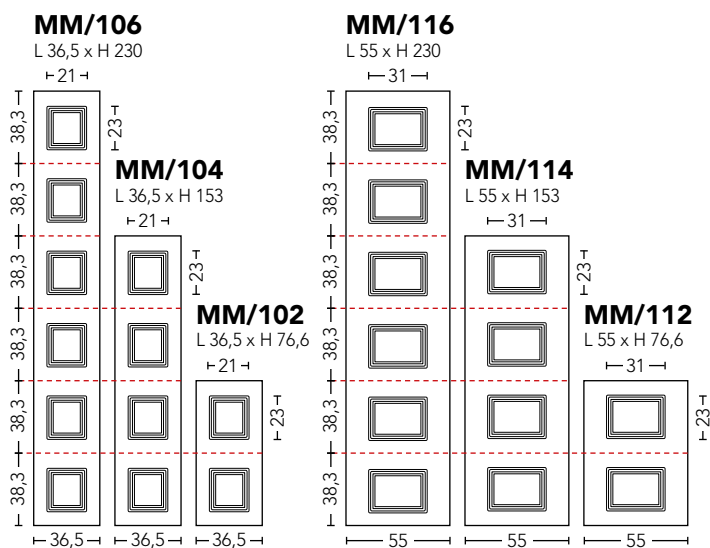

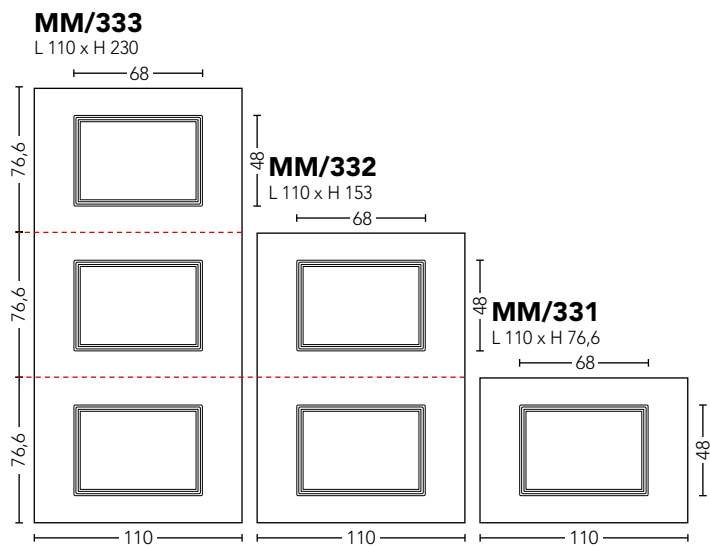
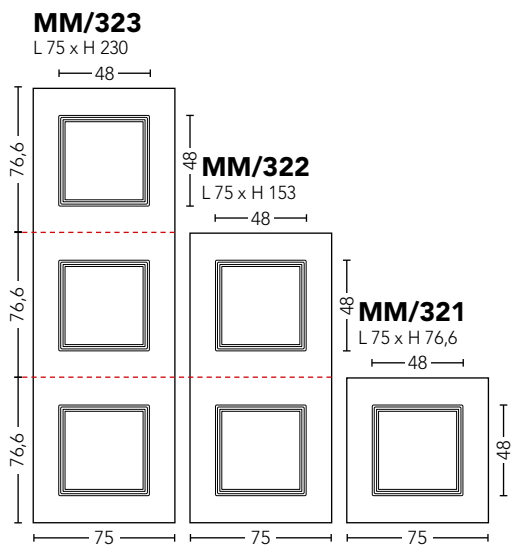
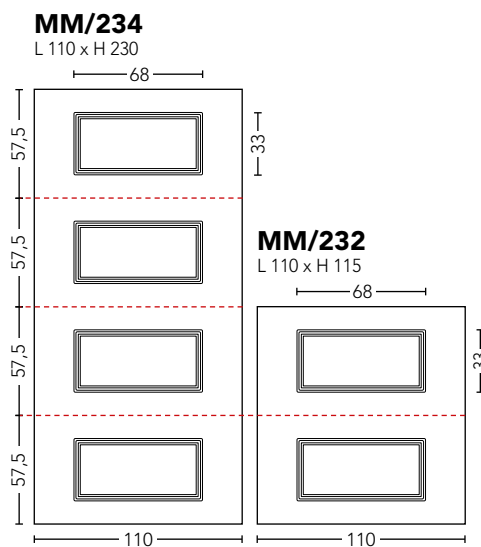
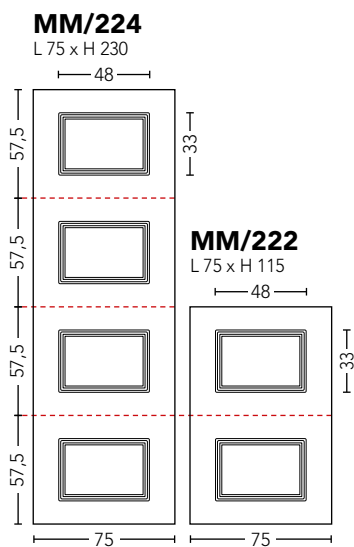
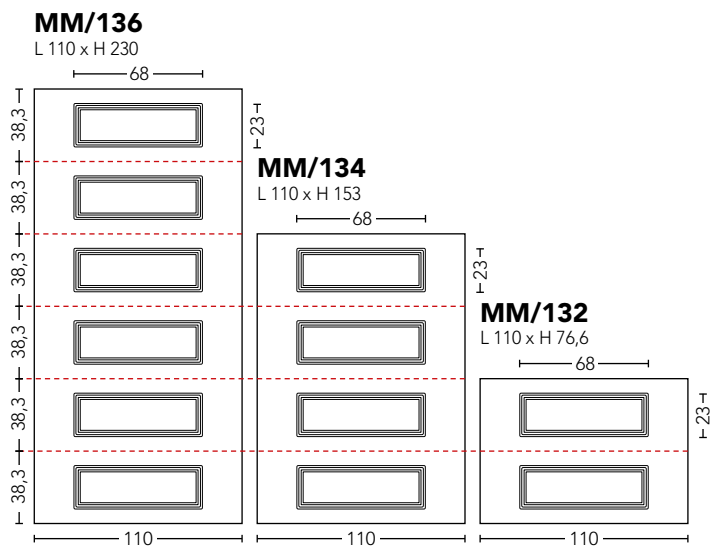
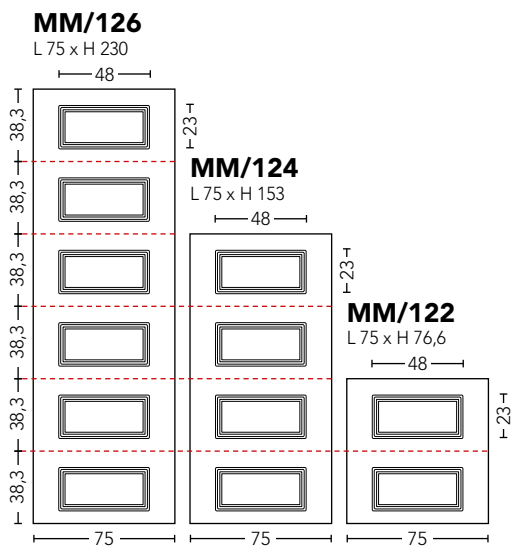

INFINITY

STYLE

A FILO

EMOTION

NOVECENTO

INCYSO

VETRI E DECORI

MANIGLIE

PENSILINE

COLORI

SEZ. TECNICA

# MINY VERSIONE TABLET

PANNELLI PER SCURI E SCURETTI

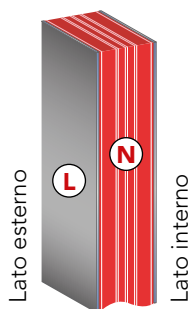

## CARATTERISTICHE

**L** - Pannello liscio su entrambi i lati, realizzato di serie dello stesso colore. **Su richiesta:** lato interno colori diversi.

**N** - Nucleo costituito da un mix di materiali particolarmente performanti, disposti in più strati, con ottime proprietà di isolamento termico.

**Dimensioni:** realizzati nei formati standard come indicati a fianco.

**Sezioni e spessori:** Vedere a pag. 539.

**Limitazioni:** tutti i colori effetto legno e Renolit, hanno le venature disposte in senso verticale rispetto al pannello.

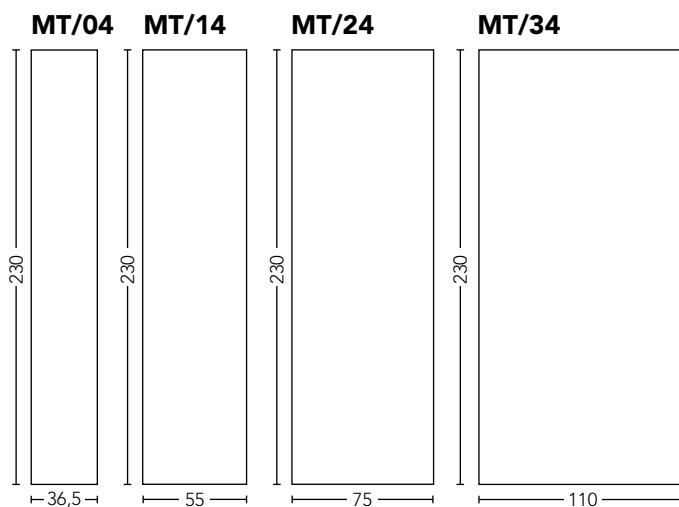
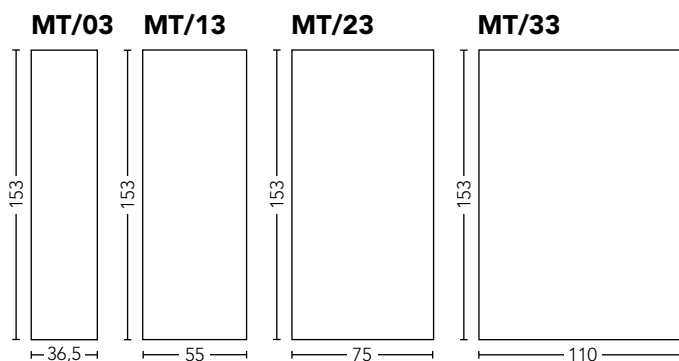
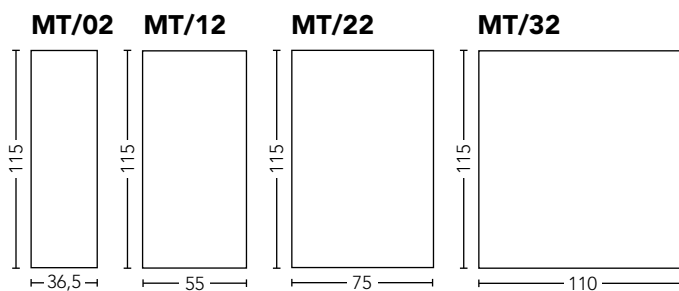
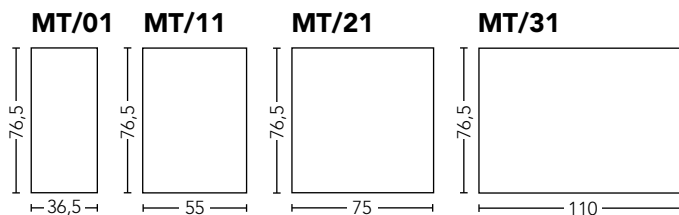



# MINY VERSIONE INCYSO

PANNELLI PER SCURI E SCURETTI

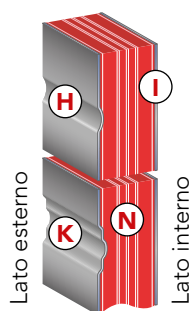

## CARATTERISTICHE

**H** - Lavorazione decorativa di mm 13 x 2 di profondità, ricavata sulla lastra di alluminio, realizzata in abbinamento alla lavorazione decorativa K, nei modelli con variante B.

**K** - Lavorazione decorativa di mm 30 x 4 di profondità, ricavata sulla lastra di alluminio.

**I** - Lato interno liscio realizzato di serie dello stesso colore del lato esterno (o colore base per i modelli bicolore). **Su richiesta:** lato interno Double (stessa lavorazione del lato esterno) e colori diversi.

**N** - Nucleo costituito da un mix di materiali particolarmente performanti, disposti in più strati, con ottime proprietà di isolamento termico.

**Dimensioni:** realizzati solo su misura.

**Sezioni e spessori:** Vedere a pag. 539.

**Limitazioni:** tutti i colori effetto legno e Renolit, hanno le venature disposte in senso verticale rispetto al pannello.

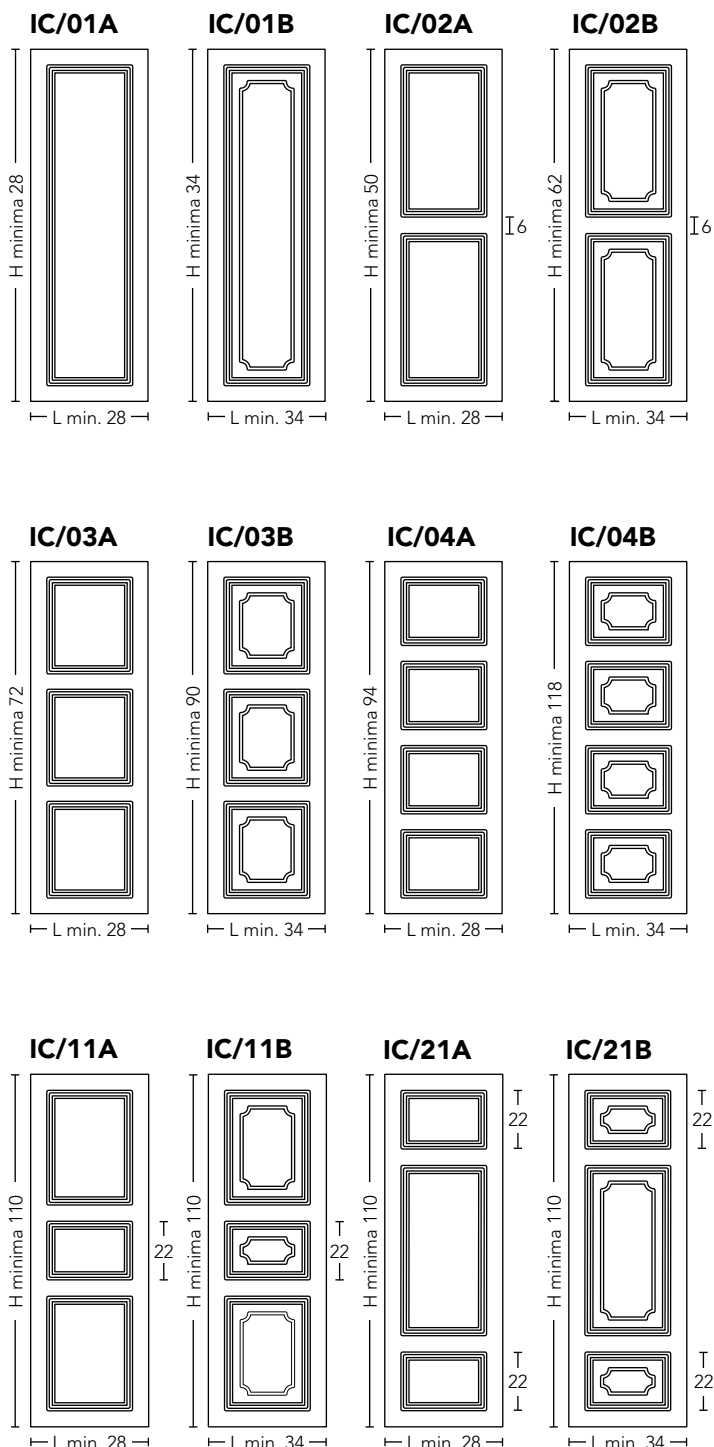

### Note:

Le lavorazioni decorative variano in proporzione alle dimensioni del pannello.

Le lavorazioni sono poste ad una distanza fissa di sei centimetri fra loro e dal bordo del pannello.

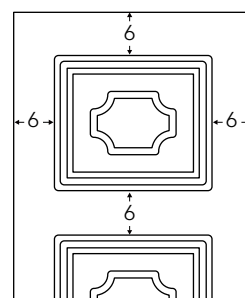

INFINITY

STYLE

A FILO

EMOTION

NOVECENTO

INCYSO

VETRI E DECORI

MANIGLIE

PENSILINE

COLORI

SEZ. TECNICA

# MINY VERSIONE A FILO

PANNELLI PER SCURI E SCURETTI

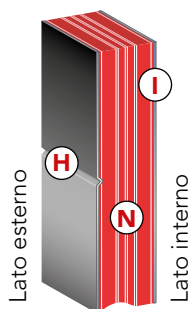

## CARATTERISTICHE

**H** - Lavorazione decorativa con bisellatura di mm 6 x 3 di profondità, ricavata sulla lastra di alluminio.

**I** - Lato interno liscio realizzato di serie dello stesso colore del lato esterno (o nel colore base per i modelli bicolore). **Su richiesta:** lato interno Double (stessa lavorazione del lato esterno) e colori diversi.

**N** - Nucleo costituito da un mix di materiali particolarmente performanti, disposti in più strati, con ottime proprietà di isolamento termico.

**Dimensioni:** realizzati solo su misura.

**Sezioni e spessori:** Vedere a pag. 539.

**Limitazioni:** tutti i colori effetto legno e Renolit, hanno le venature disposte in senso verticale rispetto al pannello.

### Modelli gruppo 1

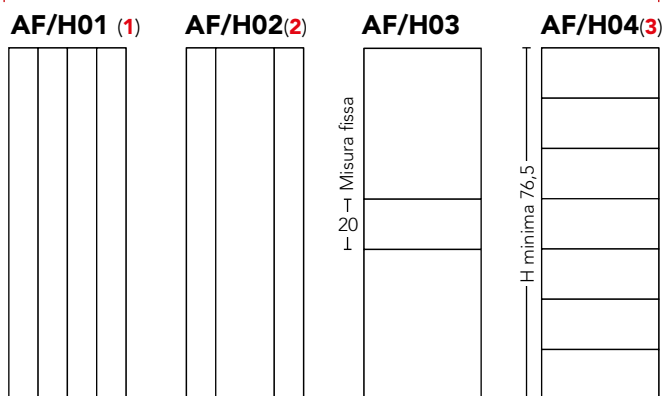

### Modelli gruppo 2

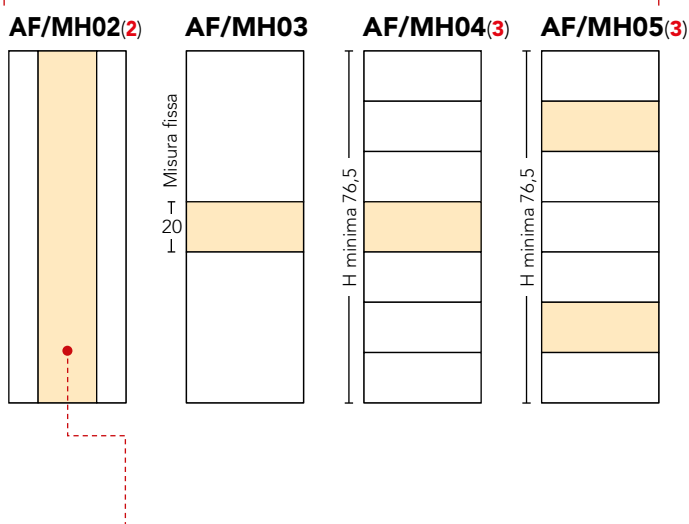

**Modelli bicolore.** I modelli realizzabili nelle finiture bicolore sono indicati nei rispettivi disegni con la parte evidenziata in colore giallo. Essa rappresenta la porzione del pannello che verrà realizzata nel 2° colore indicato nel modulo ordine. Tutto il resto del pannello, compreso il suo lato interno, sarà realizzato di serie nel colore base.

#### Note:

(1) - Larghezza delle doghe variabile fino ad un massimo di 10 cm. La loro quantità aumenta per scaglioni di **una unità** in funzione della larghezza del pannello.

(2) - Larghezza della doga centrale uguale alla metà della larghezza del pannello.

(3) - Altezza e quantità delle doghe variabile in funzione dell'altezza del pannello: fino a cm 135 n. 5 doghe, fino a cm 170 n. 7 doghe, fino a cm 250 n. 9 doghe.

# MINY VERSIONE INFINITY

PANNELLI PER SCURI E SCURETTI

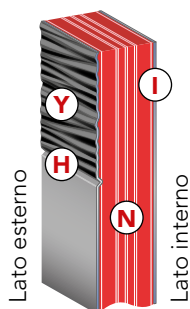

## CARATTERISTICHE

**H** - Lavorazione decorativa con bisellatura di mm 6 x 3 di profondità, ricavata sulla lastra di alluminio.

**I** - Lato interno liscio realizzato di serie dello stesso colore del lato esterno (o nel colore base per i modelli bicolore). **Su richiesta:** lato interno Double (stessa lavorazione del lato esterno) e colori diversi.

**N** - Nucleo costituito da un mix di materiali particolarmente performanti, disposti in più strati, con ottime proprietà di isolamento termico.

**Y** - Lavorazione decorativa Infinity con sinuose increspature realizzate sulla lastra di alluminio. La parte di pannello con questa lavorazione non è realizzabile nei colori della serie Skin (pellicolati) e colori legno fuori cartella.

**Dimensioni:** realizzati solo su misura.

**Sezioni e spessori:** Vedere a pag. 539.

**Limitazioni:** tutti i colori effetto legno e Renolit, hanno le venature disposte in senso verticale rispetto al pannello.

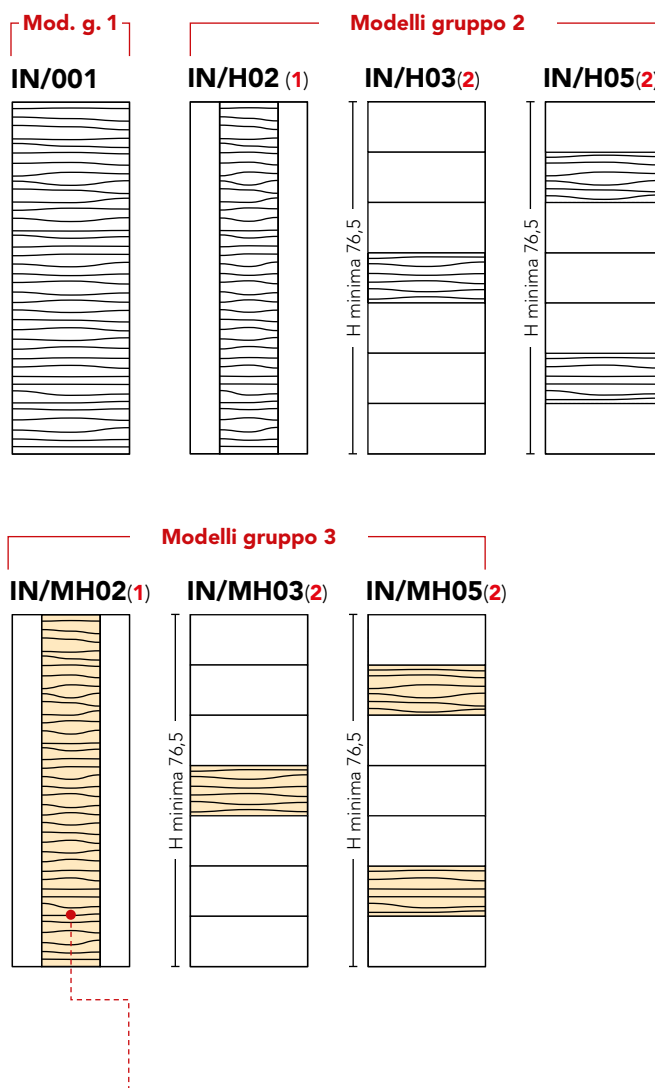

**Modelli bicolore.** I modelli realizzabili nelle finiture bicolore sono indicati nei rispettivi disegni con la parte evidenziata in colore giallo. Essa rappresenta la porzione del pannello che verrà realizzata nel 2° colore indicato nel modulo ordine. Tutto il resto del pannello, compreso il suo lato interno, sarà realizzato di serie nel colore base.

### Note:

(1) - Larghezza della doga centrale uguale alla metà della larghezza del pannello.

(2) - Altezza e quantità delle doghe variabile in funzione dell'altezza del pannello: fino a cm 135 n. 5 doghe, fino a cm 170 n. 7 doghe, fino a cm 250 n. 9 doghe.

Modello	Pag. cat.	Collez.ne	Vetro	Modello	Pag. cat.	Collez.ne	Vetro	Modello	Pag. cat.	Collez.ne	Vetro
<b>A</b>				<b>Alizar/KS</b>	376	Novec.	-	<b>Aries/K</b>	391	Novec.	-
<b>Abaco/K</b>	294	Novec.	-	<b>Amarcord/W</b>	270	Emotion	-	<b>Aries/KB</b>	390	Novec.	-
<b>Abaco/K1</b>	295	Novec.	<b>36</b>	<b>Amarcord/WD</b>	271	Emotion	-	<b>Aries/KC</b>	392	Novec.	-
<b>Abaco/KB</b>	297	Novec.	-	<b>Amarcord/WDX</b>	271	Emotion	-	<b>Aries/KS</b>	391	Novec.	-
<b>Abaco/KC</b>	296	Novec.	-	<b>Amarcord/WX</b>	271	Emotion	-	<b>Armide/Y</b>	415	Incyso	-
<b>Abaco/KM</b>	297	Novec.	-	<b>Ambra/F</b>	107	A Filo	-	<b>Asso/YM</b>	447	Incyso	-
<b>Abaco/KS</b>	295	Novec.	-	<b>Ambra/FB</b>	111	A Filo	-	<b>Asso/YS</b>	434	Incyso	-
<b>Adrar/H</b>	45	Infinity	-	<b>Ambra/FB1</b>	119	A Filo	<b>31</b>	<b>Astra/K</b>	314	Novec.	-
<b>Adrar/HS</b>	45	Infinity	-	<b>Ambra/FB4</b>	121	A Filo	<b>26</b>	<b>Astralis/W</b>	237	Emotion	-
<b>Adrar/MH</b>	44	Infinity	-	<b>Ambra/FB5</b>	123	A Filo	<b>40</b>	<b>Astralis/WX</b>	237	Emotion	-
<b>Adrar/MHS</b>	44	Infinity	-	<b>Ambra/FF</b>	125	A Filo	-	<b>Atacama/H</b>	23	Infinity	-
<b>Agry/Y</b>	448	Incyso	-	<b>Ambra/H</b>	107	A Filo	-	<b>Atacama/H1</b>	25	Infinity	<b>31</b>
<b>Agry/YM</b>	448	Incyso	-	<b>Ambra/HB</b>	111	A Filo	-	<b>Atacama/H2</b>	24	Infinity	<b>72</b>
<b>Agry/YS</b>	448	Incyso	-	<b>Ambra/HB1</b>	119	A Filo	<b>31</b>	<b>Atacama/H4</b>	25	Infinity	<b>70</b>
<b>Agus/Y</b>	438	Incyso	-	<b>Ambra/HB4</b>	121	A Filo	<b>26</b>	<b>Atacama/MH</b>	22	Infinity	-
<b>Agus/YM</b>	439	Incyso	-	<b>Ambra/HB5</b>	123	A Filo	<b>40</b>	<b>Atacama/MH1</b>	25	Infinity	<b>31</b>
<b>Agus/YS</b>	438	Incyso	-	<b>Ambra/HF</b>	125	A Filo	-	<b>Atacama/MH2</b>	24	Infinity	<b>72</b>
<b>Akira/Y</b>	417	Incyso	-	<b>Ambra/HPS</b>	118	A Filo	-	<b>Atacama/MH4</b>	25	Infinity	<b>70</b>
<b>Alchiba/W</b>	251	Emotion	-	<b>Ambra/MF</b>	107	A Filo	-	<b>Atlas/W</b>	213	Emotion	-
<b>Alchiba/WD</b>	250	Emotion	-	<b>Ambra/MFB</b>	111	A Filo	-	<b>Atlas/WS</b>	213	Emotion	-
<b>Aldebaran/K</b>	340	Novec.	-	<b>Ambra/MFB1</b>	119	A Filo	<b>31</b>	<b>Atlas/WSX</b>	213	Emotion	-
<b>Aldebaran/K2</b>	340	Novec.	<b>8</b>	<b>Ambra/MFB4</b>	121	A Filo	<b>26</b>	<b>Atlas/WX</b>	213	Emotion	-
<b>Aldebaran/KM</b>	341	Novec.	-	<b>Ambra/MFB5</b>	123	A Filo	<b>40</b>	<b>Auriga/K</b>	302	Novec.	-
<b>Aldebaran/KM1</b>	341	Novec.	<b>8</b>	<b>Ambra/MFF</b>	124	A Filo	-	<b>Auriga/KB</b>	304	Novec.	-
<b>Aldebaran/KS</b>	340	Novec.	-	<b>Ambra/MH</b>	107	A Filo	-	<b>Auriga/KB1</b>	304	Novec.	<b>33</b>
<b>Aldebaran/KS1</b>	340	Novec.	<b>8</b>	<b>Ambra/MH1</b>	108	A Filo	<b>31</b>	<b>Auriga/KBM</b>	303	Novec.	-
<b>Aleno/Y</b>	419	Incyso	-	<b>Ambra/MH4</b>	109	A Filo	<b>26</b>	<b>Auriga/KBS</b>	304	Novec.	-
<b>Alex/K</b>	320	Novec.	-	<b>Ambra/MH5</b>	109	A Filo	<b>40</b>	<b>Auriga/KC</b>	305	Novec.	-
<b>Alex/KB</b>	320	Novec.	-	<b>Ambra/MHAX</b>	115	A Filo	-	<b>Auriga/KCM</b>	305	Novec.	-
<b>Alex/KC</b>	320	Novec.	-	<b>Ambra/MHB</b>	110	A Filo	-	<b>Auriga/KCS</b>	305	Novec.	-
<b>Alex/KD</b>	320	Novec.	-	<b>Ambra/MHB1</b>	118	A Filo	<b>31</b>	<b>B</b>			
<b>Alfa/K</b>	384	Novec.	-	<b>Ambra/MHB4</b>	120	A Filo	<b>26</b>	<b>Basic/W</b>	273	Emotion	-
<b>Alfa/KBM3</b>	385	Novec.	<b>26</b>	<b>Ambra/MHB5</b>	122	A Filo	<b>40</b>	<b>Basic/WD1</b>	239	Emotion	<b>38</b>
<b>Alfa/KBM5</b>	385	Novec.	<b>26</b>	<b>Ambra/MHC1</b>	116	A Filo	<b>38</b>	<b>Basic/WM</b>	273	Emotion	-
<b>Alfa/KM</b>	385	Novec.	-	<b>Ambra/MHNCX</b>	115	A Filo	-	<b>Basic/WS</b>	272	Emotion	-
<b>Alfa/KS</b>	384	Novec.	-	<b>Ambra/MHPO</b>	112	A Filo	-	<b>Basileo/K</b>	370	Novec.	-
<b>Alfair/K</b>	338	Novec.	-	<b>Ambra/MHSM</b>	113	A Filo	-	<b>Basileo/K1</b>	371	Novec.	<b>16</b>
<b>Alfair/K2</b>	339	Novec.	<b>8</b>	<b>Ambra/MHSP</b>	112	A Filo	-	<b>Bellatrix/K</b>	354	Novec.	-
<b>Alfair/KM</b>	339	Novec.	-	<b>Ambra/MHSX</b>	114	A Filo	-	<b>Bellatrix/K1</b>	354	Novec.	<b>11</b>
<b>Alfair/KM1</b>	339	Novec.	<b>8</b>	<b>Ambra/MHTE</b>	113	A Filo	-	<b>Bellatrix/K3</b>	355	Novec.	<b>11 + 27</b>
<b>Alfair/KS</b>	338	Novec.	-	<b>Ambra/S4</b>	121	A Filo	<b>26</b>	<b>Bellatrix/K5</b>	355	Novec.	<b>11 + 27</b>
<b>Alfair/KS1</b>	339	Novec.	<b>8</b>	<b>Ametista/F</b>	107	A Filo	-	<b>Bellatrix/KM</b>	354	Novec.	-
<b>Algenib/K</b>	375	Novec.	-	<b>Ametista/FB</b>	106	A Filo	-	<b>Bellatrix/KM1</b>	354	Novec.	<b>15</b>
<b>Algenib/K2</b>	375	Novec.	<b>37</b>	<b>Ametista/FB1</b>	106	A Filo	<b>31</b>	<b>Bellatrix/KM2</b>	355	Novec.	<b>15 + 27</b>
<b>Algenib/K6</b>	375	Novec.	<b>26 + 37</b>	<b>Ametista/HB</b>	106	A Filo	-	<b>Bellatrix/KM3</b>	355	Novec.	<b>15 + 27</b>
<b>Algenib/KB</b>	372	Novec.	-	<b>Ametista/HB1</b>	106	A Filo	<b>31</b>	<b>Bellatrix/KS</b>	354	Novec.	-
<b>Algenib/KC</b>	372	Novec.	-	<b>Ametista/MFB</b>	106	A Filo	-	<b>Bellatrix/KS1</b>	354	Novec.	<b>15</b>
<b>Algenib/KD</b>	376	Novec.	-	<b>Ametista/MFB1</b>	106	A Filo	<b>31</b>	<b>Bellatrix/KS2</b>	355	Novec.	<b>15 + 27</b>
<b>Algenib/KE</b>	373	Novec.	-	<b>Ametista/MHB</b>	106	A Filo	-	<b>Bellatrix/KS3</b>	355	Novec.	<b>15 + 27</b>
<b>Algenib/KE1</b>	373	Novec.	<b>16</b>	<b>Ametista/MHB1</b>	106	A Filo	<b>31</b>	<b>Bilzen/Y</b>	418	Incyso	-
<b>Algenib/KM</b>	374	Novec.	-	<b>Andromeda/K</b>	292	Novec.	-	<b>Bimoon/W</b>	210	Emotion	-
<b>Algenib/KM1</b>	375	Novec.	<b>37</b>	<b>Andromeda/K1</b>	293	Novec.	<b>38</b>	<b>Bimoon/WX</b>	211	Emotion	-
<b>Algenib/KM3</b>	375	Novec.	<b>26 + 37</b>	<b>Andromeda/K4</b>	293	Novec.	<b>26</b>	<b>Blog/W</b>	222	Emotion	-
<b>Algenib/KS</b>	372	Novec.	-	<b>Antares/K</b>	363	Novec.	-	<b>Blog/W1</b>	223	Emotion	<b>77</b>
<b>Algenib/KS1</b>	375	Novec.	<b>37</b>	<b>Antares/KD</b>	329	Novec.	-	<b>Botein/W</b>	233	Emotion	-
<b>Algenib/KS3</b>	375	Novec.	<b>26 + 37</b>	<b>Antares/KD1</b>	328	Novec.	<b>7</b>	<b>Braille/W</b>	262	Emotion	-
<b>Alizar/K</b>	376	Novec.	-	<b>Antares/KM</b>	363	Novec.	-	<b>Braille/W1</b>	263	Emotion	<b>25</b>
<b>Alizar/KM</b>	377	Novec.	-	<b>Antares/KS</b>	363	Novec.	-	<b>Brunide/Y</b>	419	Incyso	-

Modello	Pag. cat.	Collez.ne	Vetro	Modello	Pag. cat.	Collez.ne	Vetro	Modello	Pag. cat.	Collez.ne	Vetro
<b>C</b>				<b>Diamond/MH1</b>	105	A Filo	<b>72</b>	<b>Gemini/K</b>	343	Novec.	-
<b>Cagy/Y</b>	441	Incyso	-	<b>Diamond/MHD</b>	105	A Filo	-	<b>Gemini/K1</b>	342	Novec.	<b>2</b>
<b>Calt/Y</b>	436	Incyso	-	<b>Diamond/MHD1</b>	104	A Filo	<b>72</b>	<b>Gemma/K</b>	347	Novec.	-
<b>Calt/YB</b>	437	Incyso	-	<b>Digit/W</b>	225	Emotion	-	<b>Gemma/K1</b>	346	Novec.	<b>11</b>
<b>Calt/YC</b>	437	Incyso	-	<b>Dorado/K</b>	387	Novec.	-	<b>Genius/W</b>	238	Emotion	-
<b>Calt/YM</b>	437	Incyso	-	<b>Dorado/K1</b>	387	Novec.	<b>25</b>	<b>Genius/WX</b>	239	Emotion	-
<b>Calt/YS</b>	436	Incyso	-	<b>Doss/Y</b>	446	Incyso	-	<b>Geo/K</b>	344	Novec.	-
<b>Caride/W</b>	260	Emotion	-	<b>E</b>				<b>Geo/K1</b>	344	Novec.	<b>8</b>
<b>Caride/WX</b>	260	Emotion	-	<b>Echo/K</b>	316	Novec.	-	<b>Giada/F</b>	150	A Filo	-
<b>Caser/Y</b>	440	Incyso	-	<b>Echo/Z</b>	69	Style	-	<b>Giada/FD</b>	151	A Filo	-
<b>Caser/YM</b>	441	Incyso	-	<b>Echo/Z1</b>	68	Style	<b>60</b>	<b>Giada/H</b>	151	A Filo	-
<b>Caser/YS</b>	440	Incyso	-	<b>Echo/ZX</b>	69	Style	-	<b>Giada/HD</b>	151	A Filo	-
<b>Cassiopea/K</b>	317	Novec.	-	<b>Egizy/W</b>	229	Emotion	-	<b>Gibson/H</b>	43	Infinity	-
<b>Cassiopea/Z</b>	71	Style	-	<b>Egizy/W1</b>	229	Emotion	<b>77</b>	<b>Gibson/HS</b>	43	Infinity	-
<b>Cassiopea/ZX</b>	71	Style	-	<b>Elisir/K</b>	318	Novec.	-	<b>Gibson/MH</b>	42	Infinity	-
<b>Cassiopea/ZX1</b>	70	Style	<b>53</b>	<b>Elisir/KB</b>	319	Novec.	-	<b>Gibson/MHS</b>	42	Infinity	-
<b>Castore/K</b>	386	Novec.	-	<b>Elisir/KC</b>	319	Novec.	-	<b>Gobi/H</b>	31	Infinity	-
<b>Castore/K1</b>	386	Novec.	<b>25</b>	<b>Enny/Y</b>	444	Incyso	-	<b>Gobi/H1</b>	33	Infinity	<b>31</b>
<b>Catany/Y</b>	442	Incyso	-	<b>Enny/YM</b>	445	Incyso	-	<b>Gobi/H3</b>	33	Infinity	<b>75</b>
<b>Catany/YB</b>	442	Incyso	-	<b>Enny/YS</b>	445	Incyso	-	<b>Gobi/H4</b>	32	Infinity	<b>67</b>
<b>Catany/YM</b>	442	Incyso	-	<b>Entry/Y</b>	443	Incyso	-	<b>Gobi/MH</b>	30	Infinity	-
<b>Catany/YS</b>	442	Incyso	-	<b>Eridano/K</b>	378	Novec.	-	<b>Gobi/MH1</b>	33	Infinity	<b>31</b>
<b>Channel/W</b>	257	Emotion	-	<b>Eridano/K2</b>	378	Novec.	<b>27</b>	<b>Gobi/MH3</b>	33	Infinity	<b>75</b>
<b>Channel/W2</b>	257	Emotion	<b>40</b>	<b>Eridano/K6</b>	379	Novec.	<b>27 + 26</b>	<b>Gobi/MH4</b>	32	Infinity	<b>67</b>
<b>Channel/W3</b>	257	Emotion	<b>40</b>	<b>Eridano/KM</b>	378	Novec.	-	<b>Gory/Y</b>	435	Incyso	-
<b>Cobalto/F</b>	149	A Filo	-	<b>Eridano/KM1</b>	379	Novec.	<b>27</b>	<b>Gradara/K</b>	366	Novec.	-
<b>Cobalto/F1</b>	145	A Filo	<b>77</b>	<b>Eridano/KM3</b>	379	Novec.	<b>27 + 26</b>	<b>Gradara/KB</b>	367	Novec.	-
<b>Cobalto/F3</b>	147	A Filo	<b>40</b>	<b>Eridano/KS</b>	378	Novec.	-	<b>Gradara/KB1</b>	367	Novec.	<b>36</b>
<b>Cobalto/FD</b>	149	A Filo	-	<b>Eridano/KS1</b>	378	Novec.	<b>27</b>	<b>H</b>			
<b>Cobalto/FD1</b>	145	A Filo	<b>77</b>	<b>Eridano/KS3</b>	379	Novec.	<b>27 + 26</b>	<b>Helly/Z</b>	67	Style	-
<b>Cobalto/FD3</b>	147	A Filo	<b>40</b>	<b>Ermes/K</b>	298	Novec.	-	<b>Helly/Z1</b>	66	Style	<b>60</b>
<b>Cobalto/H</b>	149	A Filo	-	<b>Ermes/K1</b>	299	Novec.	<b>34</b>	<b>Helly/ZX</b>	67	Style	-
<b>Cobalto/H1</b>	145	A Filo	<b>77</b>	<b>Ermes/KB</b>	300	Novec.	-	<b>Hidra/W</b>	243	Emotion	-
<b>Cobalto/H3</b>	147	A Filo	<b>40</b>	<b>Ermes/KB1</b>	300	Novec.	<b>34</b>	<b>Hidra/WX</b>	242	Emotion	-
<b>Cobalto/HD</b>	149	A Filo	-	<b>Ermes/KC</b>	301	Novec.	-	<b>I</b>			
<b>Cobalto/HD1</b>	145	A Filo	<b>77</b>	<b>Exagon/W</b>	249	Emotion	-	<b>Ikaro/K</b>	324	Novec.	-
<b>Cobalto/HD3</b>	147	A Filo	<b>40</b>	<b>Exagon/WX</b>	248	Emotion	-	<b>Ikaro/K1</b>	325	Novec.	<b>3</b>
<b>Cobalto/MF</b>	148	A Filo	-	<b>Exit/Y</b>	433	Incyso	-	<b>Ikaro/KB1</b>	325	Novec.	<b>14</b>
<b>Cobalto/MF1</b>	144	A Filo	<b>77</b>	<b>Exit/YM</b>	433	Incyso	-	<b>Impery/Y</b>	445	Incyso	-
<b>Cobalto/MF3</b>	146	A Filo	<b>40</b>	<b>Exit/YS</b>	433	Incyso	-	<b>Iris/K</b>	364	Novec.	-
<b>Cobalto/MFD</b>	148	A Filo	-	<b>F</b>				<b>Iris/K1</b>	365	Novec.	<b>25</b>
<b>Cobalto/MFD1</b>	145	A Filo	<b>77</b>	<b>Fendy/Z</b>	77	Style	-	<b>Iris/K3</b>	365	Novec.	<b>25</b>
<b>Cobalto/MFD3</b>	146	A Filo	<b>40</b>	<b>Fendy/Z1</b>	76	Style	<b>76</b>	<b>Iris/KC1</b>	365	Novec.	<b>25</b>
<b>Corallo/F</b>	153	A Filo	-	<b>Fendy/ZX</b>	77	Style	-	<b>Iris/Y</b>	416	Incyso	-
<b>Corallo/FS</b>	153	A Filo	-	<b>Flex/W</b>	226	Emotion	-	<b>J</b>			
<b>Corallo/H</b>	153	A Filo	-	<b>Flex/WB</b>	227	Emotion	-	<b>Joint/W</b>	264	Emotion	-
<b>Corallo/HS</b>	153	A Filo	-	<b>Flex/WB1</b>	227	Emotion	<b>77</b>	<b>Joint/WB</b>	265	Emotion	-
<b>Corallo/MF</b>	152	A Filo	-	<b>Flower/W</b>	217	Emotion	-	<b>Joint/WBX</b>	265	Emotion	-
<b>Corallo/MFS</b>	152	A Filo	-	<b>Flower/WD</b>	217	Emotion	-	<b>Joint/WC</b>	267	Emotion	-
<b>D</b>				<b>Flower/WDX</b>	216	Emotion	-	<b>Joint/WCX</b>	266	Emotion	-
<b>Deneb/K</b>	388	Novec.	-	<b>Flower/WX</b>	217	Emotion	-	<b>Joint/WD</b>	269	Emotion	-
<b>Deruta/K</b>	306	Novec.	-	<b>Forest/Y</b>	413	Incyso	-	<b>Joint/WD1</b>	269	Emotion	<b>77</b>
<b>Deruta/KB</b>	307	Novec.	-	<b>Frisè/W</b>	235	Emotion	-	<b>Joint/WDX</b>	268	Emotion	-
<b>Desire/W</b>	254	Emotion	-	<b>Frisè/WB</b>	235	Emotion	-	<b>Joint/WX</b>	264	Emotion	-
<b>Desire/WB</b>	255	Emotion	-	<b>Funny/W</b>	241	Emotion	-	<b>Jolly/HS1</b>	22	Infinity	<b>31</b>
<b>Desire/WBX</b>	255	Emotion	-	<b>Funny/WX</b>	240	Emotion	-	<b>Jolly/K</b>	403	Novec.	-
<b>Desire/WX</b>	254	Emotion	-	<b>G</b>				<b>Jolly/K1</b>	329	Novec.	<b>30</b>
<b>Diamond/MH</b>	105	A Filo	-	<b>Galaxy/W</b>	236	Emotion	-	<b>Jolly/KB</b>	331	Novec.	-

Modello	Pag. cat.	Collez.ne	Vetro	Modello	Pag. cat.	Collez.ne	Vetro	Modello	Pag. cat.	Collez.ne	Vetro
Jolly/KBG	392	Novec.	-	Labirint/W	230	Emotion	-	Mira/KM3	381	Novec.	<b>26 + 27</b>
Jolly/KBGM	392	Novec.	-	Libra/K	352	Novec.	-	Mira/KS	380	Novec.	-
Jolly/KG	292	Novec.	-	Libra/K1	353	Novec.	<b>11</b>	Mira/KS1	380	Novec.	<b>26</b>
Jolly/KG1	310	Novec.	<b>31</b>	Libra/KB	353	Novec.	-	Mira/KS2	381	Novec.	<b>26 + 27</b>
Jolly/KGM	393	Novec.	-	Line/Y	423	Incyso	-	Mira/KS3	381	Novec.	<b>26 + 27</b>
Jolly/KGM1	393	Novec.	<b>31</b>	Line/YB	423	Incyso	-	Miranda/K	356	Novec.	-
Jolly/KGM2	393	Novec.	<b>31</b>	Line/YC	422	Incyso	-	Miranda/K1	356	Novec.	<b>22</b>
Jolly/WG1	258	Emotion	<b>31</b>	Lira/K	396	Novec.	-	Miranda/K2	356	Novec.	<b>25 + 22</b>
Jolly/WM1	273	Emotion	<b>31</b>	Lira/KB	396	Novec.	-	Miranda/K3	357	Novec.	<b>25 + 22</b>
Jolly/WM2	273	Emotion	<b>31</b>	Lira/KBS	396	Novec.	-	Miranda/KB	357	Novec.	-
Jolly/YG	412	Incyso	-	Lira/KC	397	Novec.	-	Miranda/KB1	357	Novec.	<b>22</b>
Jolly/YGM	429	Incyso	-	Lira/KCS	397	Novec.	-	Mirror/Z	79	Style	-
Jolly/ZM	89	Style	-	Lira/KES	397	Novec.	-	Mirror/Z1	78	Style	<b>77</b>
Jolly/ZM1	88	Style	<b>31</b>	Lira/KFS	397	Novec.	-	Mirror/ZM	81	Style	-
Jolly/ZS	89	Style	-	Lira/KL	397	Novec.	-	Mirror/ZM1	80	Style	<b>77</b>
Jolly/ZS1	88	Style	<b>31</b>	Lira/KS	396	Novec.	-	Mirror/ZS	79	Style	-
Jolly/ZXM	89	Style	-	Lody/Y	436	Incyso	-	Mirror/ZS1	78	Style	<b>77</b>
Jolly/ZXS	89	Style	-	Luce/K1	394	Novec.	<b>77</b>	Mirror/ZX	79	Style	-
<b>K</b>				Luce/KD1	394	Novec.	<b>38</b>	Mirror/ZXM	81	Style	-
Kaffa/Y	412	Incyso	-	Luce/KE1	394	Novec.	<b>36</b>	Mirror/ZXS	79	Style	-
Kalahari/H	35	Infinity	-	Luce/KF3	395	Novec.	<b>25</b>	Mizar/K	377	Novec.	-
Kalahari/HD	35	Infinity	-	Luce/KH3	395	Novec.	<b>40</b>	Mizar/KM	377	Novec.	-
Kalahari/MH	35	Infinity	-	Luce/KH4	395	Novec.	<b>40</b>	Mizar/KS	377	Novec.	-
Kalahari/MHD	34	Infinity	-	Luce/KHS3	395	Novec.	<b>40</b>	Mojave/F	41	Infinity	-
Kalipso/K	321	Novec.	-	Luce/KHS4	395	Novec.	<b>40</b>	Mojave/MF	40	Infinity	-
Kalipso/KB	321	Novec.	-	Luce/KS1	394	Novec.	<b>77</b>	Moon/Z	73	Style	-
Kalipso/KC	321	Novec.	-	Luce/W1	274	Emotion	<b>77</b>	Moon/Z1	72	Style	<b>53</b>
Kalipso/KD	321	Novec.	-	Luce/WD1	219	Emotion	<b>38</b>	Moon/ZX	73	Style	-
Kalipso/KM	321	Novec.	-	Luce/WE1	274	Emotion	<b>36</b>	Moraga/Y	417	Incyso	-
Kalipso/KS	321	Novec.	-	Luce/WF3	275	Emotion	<b>25</b>	Moresco/Y	433	Incyso	-
Kanoa/Z	65	Style	-	Luce/WH3	275	Emotion	<b>40</b>	Moresco/YB	432	Incyso	-
Kanoa/Z1	64	Style	<b>75</b>	Luce/WH4	275	Emotion	<b>40</b>	<b>N</b>			
Kanoa/ZX	65	Style	-	Luce/WHS3	275	Emotion	<b>40</b>	Naos/Y	413	Incyso	-
Kardoa/Y	414	Incyso	-	Luce/WHS4	275	Emotion	<b>40</b>	Nasira/Y	417	Incyso	-
Kessel/Y	418	Incyso	-	Luce/WS1	274	Emotion	<b>77</b>	Niche/W	209	Emotion	-
Klio/K	308	Novec.	-	<b>M</b>				Niche/WS	209	Emotion	-
Klio/KB	309	Novec.	-	Madras/W	252	Emotion	-	Niche/WSX	209	Emotion	-
Klio/KD	308	Novec.	-	Madras/WM	253	Emotion	-	Niche/WX	209	Emotion	-
Klio/KM	309	Novec.	-	Madras/WMX	253	Emotion	-	Nysa/Y	426	Incyso	-
Klio/KS	309	Novec.	-	Madras/WS	252	Emotion	-	<b>O</b>			
Kreo/FA	178	A Filo	-	Madras/WSX	253	Emotion	-	Oblò/Z	75	Style	-
Kreo/FAS	179	A Filo	-	Madras/WX	253	Emotion	-	Oblò/Z1	74	Style	<b>51</b>
Kreo/HA	179	A Filo	-	Marsy/Y	440	Incyso	-	Oblò/ZX	75	Style	-
Kreo/HAS	179	A Filo	-	Messy/Y	439	Incyso	-	Osty/Y	443	Incyso	-
Kreo/MFA	179	A Filo	-	Minerva/K	351	Novec.	-	Over/Z	83	Style	-
Kreo/MFAS	179	A Filo	-	Minerva/K1	350	Novec.	<b>11</b>	Over/Z1	82	Style	<b>31</b>
Kreo/MFB	180	A Filo	-	Minerva/KM	351	Novec.	-	Over/ZM	83	Style	-
Kreo/MFB5	180	A Filo	<b>40</b>	Minerva/KM1	351	Novec.	<b>15</b>	Over/ZS	82	Style	-
Kreo/MFB5	180	A Filo	-	Minerva/KS	351	Novec.	-	Over/ZX	83	Style	-
Kreo/MHA	179	A Filo	-	Minerva/KS1	350	Novec.	<b>15</b>	<b>P</b>			
Kreo/MHAS	179	A Filo	-	Mintaka/Y	414	Incyso	-	Paler/Y	439	Incyso	-
Kreo/MHB	181	A Filo	-	Mira/K	380	Novec.	-	Palladio/K	326	Novec.	-
Kreo/MHB5	180	A Filo	<b>40</b>	Mira/K2	380	Novec.	<b>26</b>	Palladio/K1	327	Novec.	<b>35</b>
Kreo/MHBS	180	A Filo	-	Mira/K4	381	Novec.	<b>26 + 27</b>	Pegaso/K	322	Novec.	-
Kubo/Z	87	Style	-	Mira/K6	381	Novec.	<b>26 + 27</b>	Pegaso/KB	322	Novec.	-
Kubo/Z1	86	Style	<b>67</b>	Mira/KM	380	Novec.	-	Pegaso/KM	323	Novec.	-
Kubo/ZX	87	Style	-	Mira/KM1	380	Novec.	<b>26</b>	Pericle/Y	420	Incyso	-
<b>L</b>				Mira/KM2	381	Novec.	<b>26 + 27</b>	Pericle/YB	420	Incyso	-

Modello	Pag. cat.	Collez.ne	Vetro	Modello	Pag. cat.	Collez.ne	Vetro	Modello	Pag. cat.	Collez.ne	Vetro
Pericle/YC	421	Incyso	-	Quater/K	368	Novec.	-	Rigo/MFES	188	A Filo	-
Pericle/YD	421	Incyso	-	Quater/K4	369	Novec.	40	Rigo/MFF	188	A Filo	-
Pericle/YM	421	Incyso	-	Quater/KM	369	Novec.	-	Rigo/MFFS	188	A Filo	-
Pericle/YS	421	Incyso	-	Quater/KS	368	Novec.	-	Rigo/MFG	189	A Filo	-
Perseo/K	345	Novec.	-	<b>R</b>				Rigo/MFGS	189	A Filo	-
Perseo/K1	345	Novec.	8	Ragy/Y	434	Incyso	-	Rigo/MFH	191	A Filo	-
Point/W	232	Emotion	-	Regolo/KA	333	Novec.	-	Rigo/MFHS	191	A Filo	-
Polaris/K	310	Novec.	-	Regolo/KA1	332	Novec.	3	Rigo/MHB	183	A Filo	-
Polaris/K1	311	Novec.	27	Regolo/KB	334	Novec.	-	Rigo/MHBS	183	A Filo	-
Polaris/K2	311	Novec.	27 + 26	Regolo/KBM	334	Novec.	-	Rigo/MHC	184	A Filo	-
<b>Q</b>				Regolo/KBS	334	Novec.	-	Rigo/MHCS	184	A Filo	-
Quarzo/FC	165	A Filo	-	Regolo/KC	333	Novec.	-	Rigo/MHD	185	A Filo	-
Quarzo/FCS	165	A Filo	-	Regolo/KD	335	Novec.	-	Rigo/MHDS	185	A Filo	-
Quarzo/FD	167	A Filo	-	Regolo/KD1	335	Novec.	3	Rigo/MHE	187	A Filo	-
Quarzo/FDS	167	A Filo	-	Regolo/KDM1	335	Novec.	8	Rigo/MHES	187	A Filo	-
Quarzo/FE	169	A Filo	-	Regolo/KDS1	335	Novec.	8	Rigo/MHF	188	A Filo	-
Quarzo/FES	169	A Filo	-	Rigel/K	337	Novec.	-	Rigo/MHFS	188	A Filo	-
Quarzo/FF	170	A Filo	-	Rigel/K2	337	Novec.	2	Rigo/MHG	189	A Filo	-
Quarzo/FF5	171	A Filo	40	Rigel/KB	336	Novec.	-	Rigo/MHGS	189	A Filo	-
Quarzo/FFS	170	A Filo	-	Rigel/KM	337	Novec.	-	Rigo/MHH	191	A Filo	-
Quarzo/HC	165	A Filo	-	Rigel/KM1	337	Novec.	2	Rigo/MHHS	191	A Filo	-
Quarzo/HCS	165	A Filo	-	Rigel/KS	337	Novec.	-	Rome/Y	443	Incyso	-
Quarzo/HD	166	A Filo	-	Rigel/KS1	337	Novec.	2	Rotary/Z	57	Style	-
Quarzo/HDS	166	A Filo	-	Rigo/FB	183	A Filo	-	Rotary/Z4	56	Style	70
Quarzo/HE	169	A Filo	-	Rigo/FBS	183	A Filo	-	Rotary/ZX	57	Style	-
Quarzo/HES	169	A Filo	-	Rigo/FC	184	A Filo	-	Rubino/F	155	A Filo	-
Quarzo/HF	170	A Filo	-	Rigo/FCS	184	A Filo	-	Rubino/F1	157	A Filo	77
Quarzo/HF5	171	A Filo	40	Rigo/FD	185	A Filo	-	Rubino/FG	159	A Filo	-
Quarzo/HFS	170	A Filo	-	Rigo/FDS	185	A Filo	-	Rubino/FGS	159	A Filo	-
Quarzo/MFC	165	A Filo	-	Rigo/FE	186	A Filo	-	Rubino/FS	155	A Filo	-
Quarzo/MFCS	165	A Filo	-	Rigo/FES	186	A Filo	-	Rubino/FS1	157	A Filo	77
Quarzo/MFD	167	A Filo	-	Rigo/FF	188	A Filo	-	Rubino/H	155	A Filo	-
Quarzo/MFDS	167	A Filo	-	Rigo/FFS	188	A Filo	-	Rubino/H1	157	A Filo	77
Quarzo/MFE	169	A Filo	-	Rigo/FG	189	A Filo	-	Rubino/HG	159	A Filo	-
Quarzo/MFES	169	A Filo	-	Rigo/FGS	189	A Filo	-	Rubino/HGS	159	A Filo	-
Quarzo/MFF	174	A Filo	-	Rigo/FH	190	A Filo	-	Rubino/HS	155	A Filo	-
Quarzo/MFFS	174	A Filo	-	Rigo/FHS	190	A Filo	-	Rubino/HS1	157	A Filo	77
Quarzo/MFG	173	A Filo	-	Rigo/HB	183	A Filo	-	Rubino/MF	154	A Filo	-
Quarzo/MFGS	173	A Filo	-	Rigo/HBS	183	A Filo	-	Rubino/MF1	156	A Filo	77
Quarzo/MFL	175	A Filo	-	Rigo/HC	184	A Filo	-	Rubino/MFG	158	A Filo	-
Quarzo/MFLS	175	A Filo	-	Rigo/HCS	184	A Filo	-	Rubino/MFGS	158	A Filo	-
Quarzo/MHC	164	A Filo	-	Rigo/HD	185	A Filo	-	Rubino/MFS	156	A Filo	-
Quarzo/MHCS	164	A Filo	-	Rigo/HDS	185	A Filo	-	Rubino/MFS1	157	A Filo	77
Quarzo/MHD	166	A Filo	-	Rigo/HE	187	A Filo	-	Rubino/MH	155	A Filo	-
Quarzo/MHDS	166	A Filo	-	Rigo/HES	187	A Filo	-	Rubino/MH1	157	A Filo	77
Quarzo/MHE	168	A Filo	-	Rigo/HF	188	A Filo	-	Rubino/MHS	155	A Filo	-
Quarzo/MHES	169	A Filo	-	Rigo/HFS	188	A Filo	-	Rubino/MHS1	157	A Filo	77
Quarzo/MHF	174	A Filo	-	Rigo/HG	189	A Filo	-	<b>S</b>			
Quarzo/MHFS	174	A Filo	-	Rigo/HGS	189	A Filo	-	Sahara/H	19	Infinity	-
Quarzo/MHG	173	A Filo	-	Rigo/HH	191	A Filo	-	Sahara/HS	19	Infinity	-
Quarzo/MHG3	172	A Filo	39	Rigo/HHS	191	A Filo	-	Sahara/HS1	19	Infinity	31
Quarzo/MHGS	172	A Filo	-	Rigo/MFB	183	A Filo	-	Sandy/W	224	Emotion	-
Quarzo/MHL	175	A Filo	-	Rigo/MFBS	183	A Filo	-	Shangai/W	228	Emotion	-
Quarzo/MHLS	175	A Filo	-	Rigo/MFC	184	A Filo	-	Sien/Y	436	Incyso	-
Quasar/K	348	Novec.	-	Rigo/MFCS	184	A Filo	-	Sigma/K	389	Novec.	-
Quasar/K1	348	Novec.	11	Rigo/MFD	185	A Filo	-	Sigma/K1	389	Novec.	72
Quasar/KB	349	Novec.	-	Rigo/MFDS	185	A Filo	-	Silea/Y	447	Incyso	-
Quasar/KB3	349	Novec.	11 + 37	Rigo/MFE	187	A Filo	-	Simple/W	256	Emotion	-

Modello	Pag. cat.	Collez.ne	Vetro	Modello	Pag. cat.	Collez.ne	Vetro	Modello	Pag. cat.	Collez.ne	Vetro
Sira/Y	445	Incyso	-	Subra/Y	424	Incyso	-	Trilogy/WX	261	Emotion	-
Sirio/K	330	Novec.	-	Subra/YB	425	Incyso	-	<b>U</b>			
Sirio/K1	330	Novec.	3	Subra/YC	425	Incyso	-	Urania/K	323	Novec.	-
Sirio/KC	331	Novec.	-	Subra/YM	425	Incyso	-	Urbis/Y	445	Incyso	-
Sirio/KE	331	Novec.	-	Subra/YS	424	Incyso	-	<b>V</b>			
Smeraldo/H	177	A Filo	-	Sunray/Z	59	Style	-	Varesy/Y	449	Incyso	-
Smeraldo/MH	176	A Filo	-	Sunray/Z4	58	Style	70	Varesy/YB	449	Incyso	-
Smoky/W	220	Emotion	-	Sunray/ZX	59	Style	-	Varesy/YS	449	Incyso	-
Soffy/W	218	Emotion	-	<b>T</b>				Vele/Z	61	Style	-
Soffy/WX	219	Emotion	-	Tablet/Y	430	Incyso	-	Vele/Z2	60	Style	57 + 58
Sonora/F	37	Infinity	-	Tablet/YS	430	Incyso	-	Vele/ZX	61	Style	-
Sonora/F1	38	Infinity	77	Tacobo/Y	415	Incyso	-	Victoria/K	313	Novec.	-
Sonora/F3	39	Infinity	75	Taor/Y	439	Incyso	-	Victoria/K1	313	Novec.	22
Sonora/FD	36	Infinity	-	Taris/Y	415	Incyso	-	Vintage/W	247	Emotion	-
Sonora/FD1	38	Infinity	77	Tenerè/H	21	Infinity	-	<b>W</b>			
Sonora/FD3	39	Infinity	75	Tenerè/MH	20	Infinity	-	Wadirum/H	29	Infinity	-
Sonora/MF	37	Infinity	-	Tetris/W	233	Emotion	-	Wadirum/H1	27	Infinity	31
Sonora/MF1	38	Infinity	77	Tetris/W1	233	Emotion	67	Wadirum/H4	27	Infinity	67
Sonora/MF3	39	Infinity	75	Tiffany/Y	413	Incyso	-	Wadirum/MH	28	Infinity	-
Sonora/MFD	37	Infinity	-	Titano/K	382	Novec.	-	Wadirum/MH1	26	Infinity	31
Sonora/MFD1	38	Infinity	77	Titano/K2	383	Novec.	26	Wadirum/MH4	27	Infinity	67
Sonora/MFD3	39	Infinity	75	Titano/KM	383	Novec.	-	Wind/W	212	Emotion	-
Sorren/Y	435	Incyso	-	Titano/KM1	383	Novec.	26	Wind/WX	212	Emotion	-
Space/W	245	Emotion	-	Titano/KS	383	Novec.	-	Wood/W	225	Emotion	-
Space/WX	244	Emotion	-	Titano/KS1	383	Novec.	26	<b>Z</b>			
Spiga/YA	427	Incyso	-	Topazio/FD	163	A Filo	-	Zaffiro/F	127	A Filo	-
Spiga/YAM	427	Incyso	-	Topazio/FD3	163	A Filo	40	Zaffiro/F4	129	A Filo	26
Spiga/YAS	427	Incyso	-	Topazio/FDS	163	A Filo	-	Zaffiro/FB	133	A Filo	-
Spiga/YB	427	Incyso	-	Topazio/FDS3	163	A Filo	40	Zaffiro/FB1	131	A Filo	77
Spiga/YC	429	Incyso	-	Topazio/HD	162	A Filo	-	Zaffiro/FB2	135	A Filo	72
Spiga/YCM	429	Incyso	-	Topazio/HD3	163	A Filo	40	Zaffiro/FC	137	A Filo	-
Spiga/YCS	429	Incyso	-	Topazio/HDS	162	A Filo	-	Zaffiro/FD	139	A Filo	-
Spiga/YD	426	Incyso	-	Topazio/HDS3	163	A Filo	40	Zaffiro/FD3	141	A Filo	40
Spiga/YE	427	Incyso	-	Topazio/MFB	161	A Filo	-	Zaffiro/FE	142	A Filo	-
Spiga/YF	429	Incyso	-	Topazio/MFBS	161	A Filo	-	Zaffiro/FE5	143	A Filo	40
Spiga/YG	428	Incyso	-	Topazio/MFC	162	A Filo	-	Zaffiro/H	127	A Filo	-
Spiga/YGM	429	Incyso	-	Topazio/MFCS	162	A Filo	-	Zaffiro/H4	129	A Filo	26
Spiga/YGS	428	Incyso	-	Topazio/MFE	161	A Filo	-	Zaffiro/HB	133	A Filo	-
Spiga/YM	427	Incyso	-	Topazio/MFES	161	A Filo	-	Zaffiro/HB1	131	A Filo	77
Spiga/YS	427	Incyso	-	Topazio/MHB	160	A Filo	-	Zaffiro/HB2	135	A Filo	72
Spin/Z	63	Style	-	Topazio/MHBS	160	A Filo	-	Zaffiro/HC	137	A Filo	-
Spin/Z2	62	Style	57 + 58	Topazio/MHC	162	A Filo	-	Zaffiro/HD	139	A Filo	-
Spin/ZX	63	Style	-	Topazio/MHCS	162	A Filo	-	Zaffiro/HD3	141	A Filo	40
Stilus/K	312	Novec.	-	Topazio/MHCS	162	A Filo	-	Zaffiro/HE	142	A Filo	-
Stilus/K1	312	Novec.	16	Topazio/MHE	161	A Filo	-	Zaffiro/HE5	143	A Filo	40
Stone/W	215	Emotion	-	Topazio/MHES	161	A Filo	-	Zaffiro/MF	127	A Filo	-
Stone/WD	215	Emotion	-	Trapy/Y	447	Incyso	-	Zaffiro/MF4	129	A Filo	26
Stone/WDX	214	Emotion	-	Triade/K	358	Novec.	-	Zaffiro/MFB	132	A Filo	-
Stone/WX	215	Emotion	-	Triade/K1	359	Novec.	25	Zaffiro/MFB1	130	A Filo	77
Stream/W	231	Emotion	-	Triade/KB	362	Novec.	-	Zaffiro/MFB2	134	A Filo	72
Stream/W1	231	Emotion	72	Triade/KBM	362	Novec.	-	Zaffiro/MFC	136	A Filo	-
Strip/W	259	Emotion	-	Triade/KBS	362	Novec.	-	Zaffiro/MFD	138	A Filo	-
Strip/W1	258	Emotion	77	Triade/KC	360	Novec.	-	Zaffiro/MFD3	140	A Filo	40
Strip/WM	259	Emotion	-	Triade/KC1	361	Novec.	25	Zaffiro/MFE	142	A Filo	-
Strip/WMX	259	Emotion	-	Triade/YS	416	Incyso	-	Zaffiro/MFE5	143	A Filo	40
Strip/WS	259	Emotion	-	Triangolo/Z	85	Style	-	Zaffiro/MH	127	A Filo	-
Strip/WSX	259	Emotion	-	Triangolo/Z1	84	Style	72	Zaffiro/MH1	126	A Filo	31
Strip/WX	259	Emotion	-	Triangolo/ZX	85	Style	-	Zaffiro/MH4	128	A Filo	26
				Trilogy/W	261	Emotion	-				



# MODULI ORDINE

scaricabili su [www.royalpat.it](http://www.royalpat.it), sezione "moduli ordine"

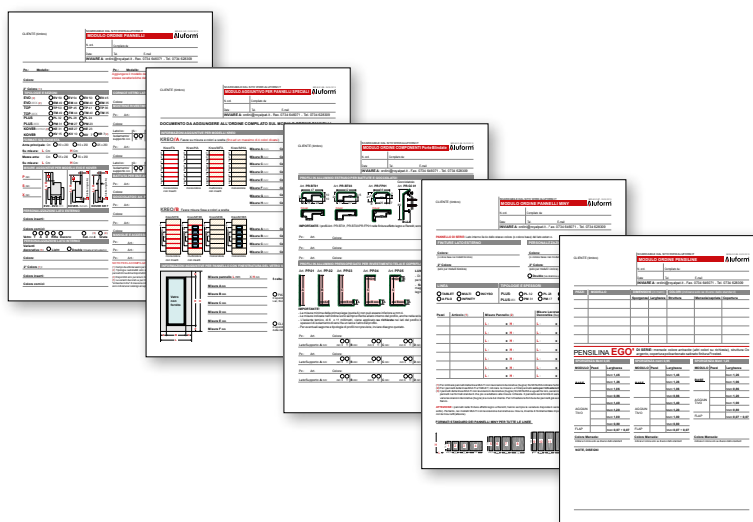

Al fine di evitare errori di interpretazione, gli ordini dovranno essere inoltrati tramite gli appositi moduli e trasmessi via Fax allo 0734 646071, oppure via e-mail a [ordini@royalpat.it](mailto:ordini@royalpat.it). Non saranno pertanto accolti eventuali reclami per ordini errati o incompleti inoltrati in altre forme.

Modifiche o annullamenti possono essere accolti entro le 24 ore successive alla data di ricevimento dell'ordine. Oltre tale termine l'ordine è considerato definitivo, senza possibilità di annullamento o modifiche.



#### **MODIFICHE AL PRODOTTO**

Aluform si riserva la facoltà di apportare modifiche tecniche ai prodotti senza obbligo di preavviso.

Il documento valido per qualsiasi riferimento è il catalogo on-line, costantemente aggiornato e consultabile sul sito [www.aluform.it](http://www.aluform.it)

#### **RIFERIMENTI**

Immagini e ambientazioni inserite in questo catalogo sono in parte frutto di elaborazioni al computer e hanno l'unico scopo di rappresentare i prodotti nel loro aspetto più emozionale e suggestivo. Luci, ombre, prospettive e limiti di stampa possono variare l'aspetto estetico del prodotto, e in modo ancora più significativo le tonalità dei colori, per i quali l'unico riferimento valido restano i rispettivi campioni.

#### **PROPRIETÀ INTELLETTUALE**

È vietata la riproduzione, la modifica anche parziale e in qualsiasi forma di testi, immagini, loghi e marchi contenuti in questo catalogo, senza autorizzazione scritta da parte di Royal Pat S.r.l. I modelli dei prodotti presentati in questo catalogo: porte, pannelli, maniglie, pensiline, ecc. sono protetti da brevetti di design, dei quali solo Royal Pat S.r.l. detiene ogni diritto esclusivo e interverrà a tutela dei propri diritti in caso di atti di concorrenza sleale per imitazione servile.

**Aluform®**

Edizione Aprile 2019  
Cod. MPC056

- Ideazione e progettazione grafica: Dam-co  
- Render e fotoinserimento: Royal Pat  
- Stampa: Arti Grafiche La Moderna

ALUFORM  
è un marchio



**ROYAL PAT** S.r.l. Unip.  
Via Campiglione, 20  
63900 FERMO  
Tel. 0734 628303  
Fax 0734 628201  
info@royalpat.it  
www.royalpat.it