

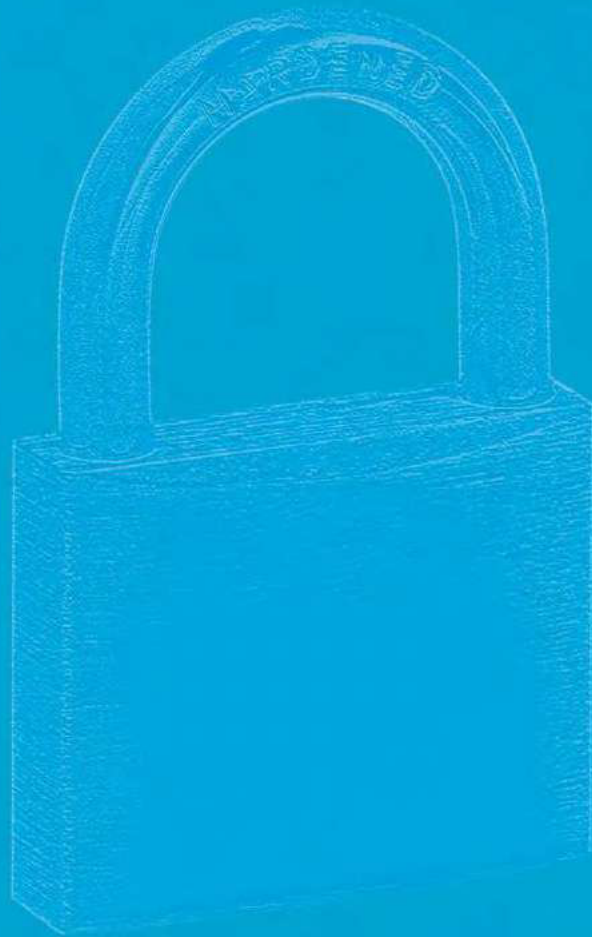

Catalogo Generale Italia 2018

Capitolo 3

Lucchetti



ASSA ABLOY

The global leader in
door opening solutions



Lucchetti standard

Lucchetti marini

Lucchetti a combinazione

Lucchetti a baionetta e in acciaio

Lucchetti corazzati e a campana

Lucchetti speciali di sicurezza

Lucchetti da viaggio

Mini lucchetti fashion

Accessori





Lucchetti standard



Yale pag. 98 – Corbin pag. 104

Lucchetti marini



Yale pag. 100 – Corbin pag. 105

Lucchetti a combinazione



Yale pag. 101 – Corbin pag. 106

Lucchetti a baionetta e in acciaio



Yale pag. 102 – Corbin pag. 106

Lucchetti corazzati e a campana

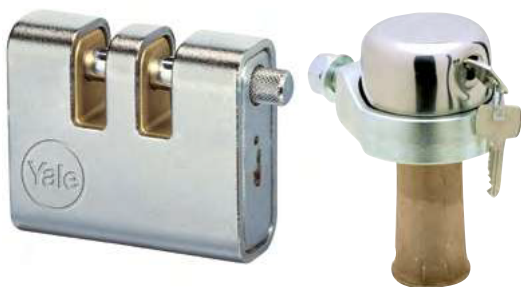

Yale pag. 103 – Corbin pag. 106

Lucchetti speciali di sicurezza



pag. 109





Indice Visuale



Lucchetti da viaggio



pag. 114

Mini lucchetti fashion



pag. 118



Accessori





pag. 119

Corrispondenze Corbin-Yale



Vecchia gamma	Gamma attuale	Compatibilità
		
Basic	Basic	Basic
PL 180	PL 110	Compatibile
PL 182	PL 112	Compatibile
-	-	-
-	PL 112	-
-	PL 122	-
-	PL 020	-
PL 381	PL 311	Compatibile
PL 281	PL 211	Compatibile
-	-	-
-	-	-
-	-	-
-	-	-

Vecchia gamma	Gamma attuale	Gamma attuale
		
Std	Top	Top
PL 010	Y 110	Non Compatibile
PL 012	Y 113	Non Compatibile
PL 015	Y 110/50	Non Compatibile
PL 100	Y 114	Non Compatibile
PL 102	Y 115	Non Compatibile
PL 020	Y 150/	Non Compatibile
PL 301	Y 114/	Non Compatibile
PL 201	Y 160ME	Compatibile
PL 202	Y 160ME	Compatibile
PL 431	Y 164	Compatibile
PL 400	Y 170	Compatibile
PL 801	Y 130	Non Compatibile



Lucchetti Yale

Lucchetti standard Y 110

Caratteristiche

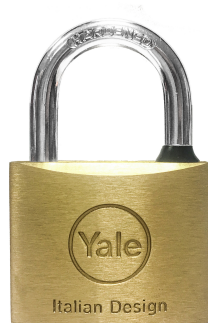
- Corpo in ottone
- Arco carbonitrurato
- Anello in gomma per proteggere i meccanismi interni
- N°2 chiavi
- Doppio sistema di chiusura per lucchetti con corpo > 30 mm
- Spina anti grimaldello per lucchetti con corpo > 30 mm
- KD e KA
- Retrofit Corbin
- Europadlock per mm 30, 40 e 50: serie dedicata



Codice	A (mm)	B (mm)	C (mm)	D (mm)	E (mm)	P	Chiave		
Y1100020X	21	25	11	3	11	4	Y01024001VX	12	45
Y1100025X	25	25	14	4	13	4	Y01024001VX	6	51
Y1100030X	30	28	16	5	15	4	Y01010001VX	6	91
Y1100040X	40	33	22	6	21	5	Y01013001VX	6	150
Y1100050X	50	39	25	8	26	5	Y01008001VX	6	280
Y1100060X	60	45	32	10	31	5	Y01008001VX	6	400
Y1100070X	70	51	37	11	37	6	Y01006001VX	6	635
Y1100020080X	21	25	11	3	11	4	Y01024001VX	6	71
Y1100025080X	25	25	14	4	13	4	Y01024001VX	6	83
Y1100030080X	30	28	16	5	15	4	Y01010001VX	6	120
Y1100040080X	40	33	22	6	21	5	Y01013001VX	6	180
Y1100050080X	50	39	25	8	26	5	Y01008001VX	12	315
Y1100060080X	60	45	32	10	31	5	Y01008001VX	6	460

Scatola

Blister

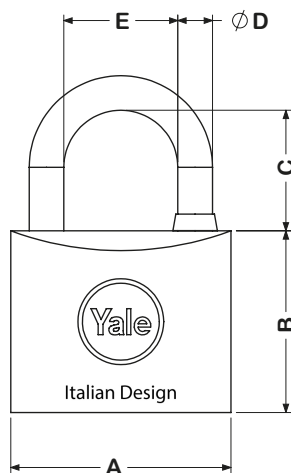

Lucchetti Yale

Lucchetti standard Y 113

Caratteristiche

- Corpo in ottone
- Arco carbonitrurato a lunga luce
- Anello in gomma per proteggere i meccanismi interni
- N°2 chiavi
- Doppio sistema di chiusura per lucchetti con corpo > 30 mm
- Spina anti grimaldello per lucchetti con corpo > 30 mm
- KD e KA
- Retrofit Corbin
- Europadlock per mm 30, 40 e 50: serie dedicata

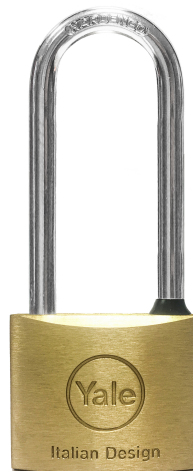

	Codice	A (mm)	B (mm)	C (mm)	D (mm)	E (mm)	P	Chiave		
Scatola	Y1130025X	25	25	28	4	11	4	Y01024001VX	12	45
	Y1130030X	30	26	40	5	15	4	Y01010001VX	6	51
	Y1130040X	40	33	66	6	20	5	Y01013001VX	6	91
	Y1130050X	50	39	91	8	26	5	Y01008001VX	6	150
	Y1130060X	60	45	128	10	31	5	Y01008001VX	6	280
Blister	Y1130025080X	25	26	28	4	11	4	Y01010001VX	6	71
	Y1130030080X	30	26	40	5	15	4	Y01010001VX	6	83
	Y1130040080X	40	33	66	6	20	5	Y01013001VX	6	120
	Y1130050080X	50	39	91	8	26	5	Y01008001VX	6	180
	Y1130060080X	60	45	128	10	31	5	Y01008001VX	12	315

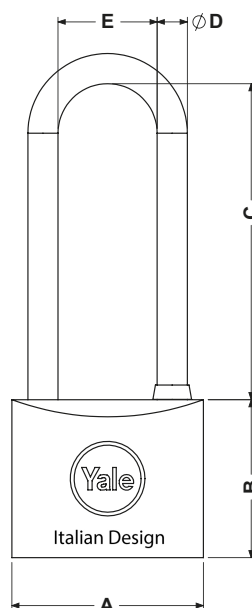

Lucchetti Yale

Lucchetti marini - Y 114

Caratteristiche

- Corpo in ottone cromato
- Arco in acciaio inox
- Anello in gomma per proteggere i meccanismi interni
- N°2 chiavi
- Doppio sistema di chiusura per lucchetti con corpo > 30 mm
- Spina anti grimaldello per lucchetti con corpo > 30 mm
- KD e KA

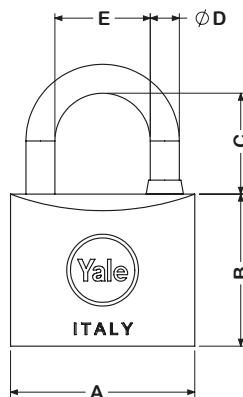

Codice	A (mm)	B (mm)	C (mm)	D (mm)	E (mm)	P	Chiave		
Y1140030X	30	28	16	5	15	4	Y01010001VX	12	45
Y1140040X	40	33	22	6	21	5	Y01013001VX	6	51
Y1140050X	50	39	25	8	26	5	Y01008001VX	6	91
Y1140030080X	30	28	16	5	15	4	Y01010001VX	6	71
Y1140040080X	40	33	22	6	21	5	Y01013001VX	6	83
Y1140050080X	50	39	25	8	26	5	Y01008001VX	6	120

Scatola

Blister

Lucchetti marini - Y 115

Caratteristiche

- Corpo in ottone cromato a lunga luce
- Anello in gomma per proteggere meccanismi interni
- Arco in acciaio inox
- N°2 chiavi
- Doppio sistema di chiusura per lucchetti con corpo > 30 mm
- Spina anti grimaldello per lucchetti con corpo > 30 mm
- KD e KA

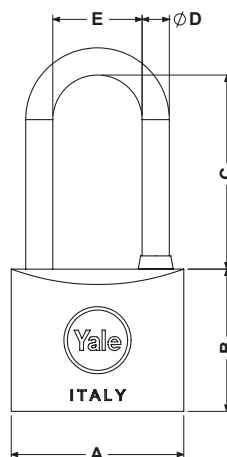

Codice	A (mm)	B (mm)	C (mm)	D (mm)	E (mm)	P	Chiave		
Y1150030X	30	28	40	5	15	4	Y01010001VX	12	90
Y1150040X	40	33	66	6	20	5	Y01013001VX	12	160
Y1150050X	50	39	91	8	26	5	Y01008001VX	12	280
Y1150030080X	30	28	40	5	15	4	Y01010001VX	12	100
Y1150040080X	40	33	66	6	20	5	Y01013001VX	12	170
Y1150050080X	50	39	91	8	26	5	Y01008001VX	12	290

Scatola

Blister

Lucchetti Yale

Lucchetti a combinazione Y 150



Caratteristiche

- Corpo in ottone massiccio
- Arco in acciaio cromato
- Combinazione variabile
- Confezione in blister

Cambio combinazione effettuabile con arco in posizione ruotata di 90°



Blister

Codice	A (mm)	B (mm)	C (mm)	D (mm)	E (mm)	 pz.	 gr.
YY150/22/120/1	22	32	21	3	8	6	40
YY150/22/120/2	22	32	21	3	8	6	80
YY150/30/125/1	31	41	26	4	14	6	120
YY150/40/130/1	40	48	28	6	19	6	220

Codice riga 1 & 2: combinazione a n°3 cifre

Codice riga 3 & 4: combinazione a n°4 cifre

Set di n°2 pz. su Yxxx/22/xxx/2

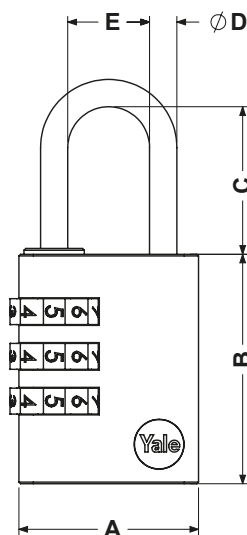

Lucchetti Yale



3

Lucchetti a baionetta Y 114

Caratteristiche

- Corpo in ottone
- Gancio carbonitrurato
- N°3 chiavi
- KD e KA

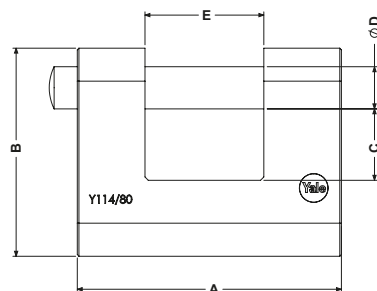

Codice	A (mm)	B (mm)	C (mm)	D (mm)	E (mm)	P	Chiave		
Y114/50/111/1	50	46	12	8	20	5	Y114/50/100	6	40
Y114/60/114/1	60	50	15	9	26	5	Y114/50/100	6	80
Y114/70/113/1	70	56	13	10	32	5	Y114/80/100	6	120
Y114/80/118/1	80	64	19	13	36	5	Y114/80/100	6	220
Y114/90/127/1	90	73	27	13	41	5	Y114/80/100	6	770

Blister

Lucchetti acciaio Y 164

Caratteristiche

- Corpo in acciaio carbonitrurato
- Gancio cementato temprato
- N°3 chiavi
- KD e KA
- Compatibile e Retrofit chiavi CORBIN Lucchetti GRIZZLY

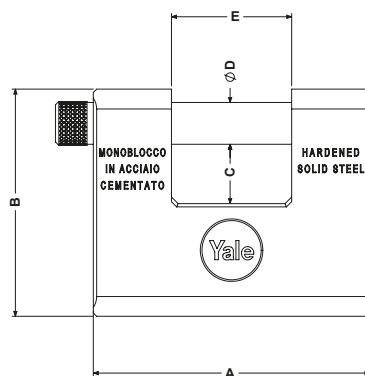

Codice	A (mm)	B (mm)	C (mm)	D (mm)	E (mm)	P	Chiave		
Y1640185	84	69	18	12,7	36,5	6	Y016C106	6	1.050

Scatola

Lucchetti Yale

Lucchetti corazzati Y 160ME

Caratteristiche

- 1 o 2 luci
- Corpo in ottone rivestito da corazza in acciaio carbonitrurato
- Gancio cementato temprato
- Dotati di doppio sistema di chiusura
- N°3 chiavi
- KD e KA
- Compatibile e Retrofit chiavi CORBIN Lucchetti CORAZZATI serie dedicata

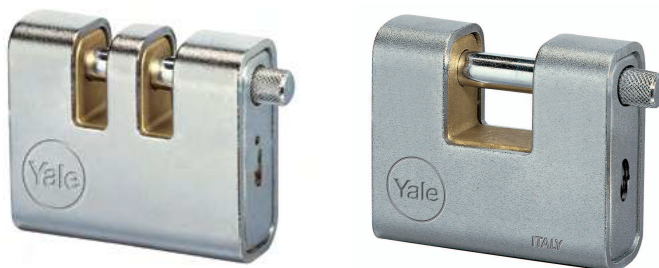

Scatola

Codice	A (mm)	B (mm)	C (mm)	D (mm)	E (mm)	P	Chiave		
Y160ME60	62	55	12	10	22	5	01008#000B084000	6	500
Y160ME80	82	69	14	11	30	5	01008#000B084000	6	500
Y160ME90	91	75	17	12	36	5	01008#000B084000	6	500
Y160ME82	81	69	10	11	12	5	01008#000B084000	6	500
Y160ME92	91	75	12	12	15	5	01008#000B084000	6	500

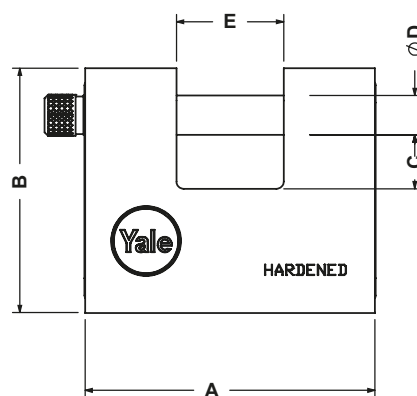
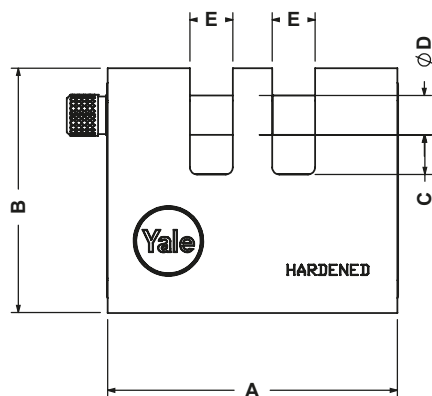

Lucchetti a campana Y 170

Caratteristiche

- Corpo in zama rivestito da corazza in acciaio inox
- Gancio di chiusura cementato temprato
- N°3 chiavi
- KD e KA
- Compatibile e Retrofit chiavi CORBIN Lucchetti CAMPANA



Scatola

Codice	Chiave		
Y1700081	01008#000B084000	1	2.350
Y1700181	01008#000B084000	1	1.320

(codice riga 2 per il solo lucchetto a campana)

Lucchetti Corbin



Lucchetti Corbin PL110

Caratteristiche

- Corpo in ottone
- Arco carbonitrurato
- N°2 chiavi
- Doppio sistema di chiusura per lucchetti con corpo > 30 mm
- Spina anti grimaldello per lucchetti con corpo > 30 mm
- KD e KA con cifratura obbligatoria
- Compatibile e Retrofit chiavi CORBIN Lucchetti PRIUM

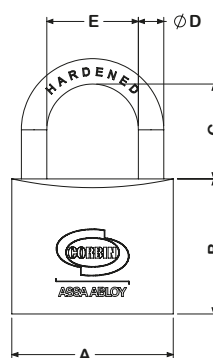

Codice	A (mm)	B (mm)	C (mm)	D (mm)	E (mm)	P	Chiave		
PL1102*00000000	20	20	12	3	10	3	PK75055010000V2	12	35
PL1102**00000000	25	25	14	4	14	4	PK75056010000V2	12	60
PL1103*00000000	30	28	17	5	15	4	PK75057010000V2	12	88
PL1104*00000000	40	33	23	6	23	5	PK75058010000V2	12	155
PL1105*00000000	50	40	30	8	28	5	PK75059010000V2	6	270
PL1106*00000000	60	42	38	9	32	5	PK75059010000V2	6	398
PL1107*00000000	70	48	42	11	40	5	PK75059010000V2	4	650

Scatola o Blister

* 0 per la scatola, 1 per il blister

** 5 per la scatola, 6 per il blister

Lucchetti Corbin PL112

Caratteristiche

- Corpo in ottone
- Arco carbonitrurato a lunga luce
- N°2 chiavi
- Doppio sistema di chiusura per lucchetti con corpo > 30 mm
- Spina anti grimaldello per lucchetti con corpo > 30 mm
- KD e KA con cifratura obbligatoria
- Compatibile e Retrofit chiavi CORBIN Lucchetti PRIUM

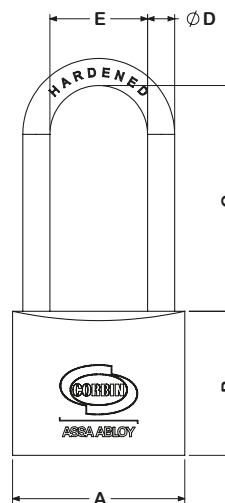

Codice	A (mm)	B (mm)	C (mm)	D (mm)	E (mm)	P	Chiave		
PL1122*00000000	20	20	23	3	10	3	PK75055010000V2	12	41
PL1122**00000000	25	25	25	4	14	4	PK75056010000V2	12	70
PL1123*00000000	30	28	32	5	15	4	PK75057010000V2	12	97
PL1124*00000000	40	33	41	6	23	5	PK75058010000V2	12	178
PL1125*00000000	50	40	80	8	28	5	PK75059010000V2	6	334

Scatola o Blister

* 0 per la scatola, 1 per il blister

** 5 per la scatola, 6 per il blister

Lucchetti Corbin



Lucchetti marini PL120

Caratteristiche

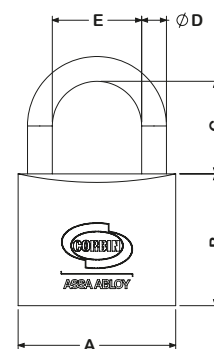
- Corpo in ottone cromato lucido
- Arco in ottone cromato lucido con anello in gomma per proteggere meccanismi interni
- N°2 chiavi
- Doppio sistema di chiusura per lucchetti con corpo > 30 mm
- Spina anti grimaldello per lucchetti con corpo > 30 mm
- KD e KA con cifratura obbligatoria



Scatola e Blister

Codice	A (mm)	B (mm)	C (mm)	D (mm)	E (mm)	P	Chiave		
PL1203*00000000	30	28	17	5	15	4	PK75057010000V2	12	88
PL1204*00000000	40	33	23	6	23	5	PK75058010000V2	12	155
PL1205*00000000	50	40	30	8	28	5	PK75059010000V2	6	270

* 0 per la scatola, 1 per il blister



Lucchetti marini PL122

Caratteristiche

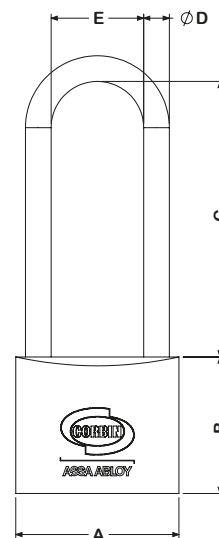
- Corpo in ottone cromato lucido
- Arco in ottone cromato lucido, a lunga luce, con anello in gomma per proteggere meccanismi interni
- N°2 chiavi
- Doppio sistema di chiusura per lucchetti con corpo > 30 mm
- Spina anti grimaldello per lucchetti con corpo > 30 mm
- Spina anti grimaldello da lucchetti > mm 30
- KD e KA con cifratura obbligatoria



Scatola e Blister

Codice	A (mm)	B (mm)	C (mm)	D (mm)	E (mm)	P	Chiave		
PL1223*00000000	30	28	32	5	15	4	PK75057010000V2	12	97
PL1224*00000000	40	33	41	6	23	5	PK75058010000V2	12	178
PL1225*00000000	50	40	80	8	28	5	PK75059010000V2	12	295

* 0 per la scatola, 1 per il blister

Lucchetti Corbin

3

Lucchetti Kombo PL020

Caratteristiche

- Gancio standard
- Corpo in ottone
- Arco acciaio cromato

Cambio combinazione effettuabile con arco in posizione ruotata di 180°

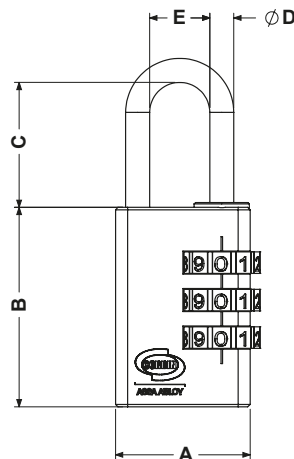

Codice	A (mm)	B (mm)	C (mm)	D (mm)	E (mm)	P			
PL02021000000V1	21	30	22	3	9	-	12	40	Blister
PL02031000000V1	30	41	26	5	13	-	12	120	
PL02041000000V1	38	49	30	6	19	-	12	220	

Lucchetti a baionetta PL311

Caratteristiche

- Corpo in ottone
- Gancio carbonitrurato
- N°3 chiavi
- KD e KA con cifratura obbligatoria
- Compatibile e Retrofit chiavi CORBIN Lucchetti PRIUM

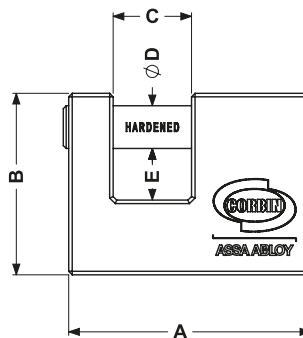

Codice	A (mm)	B (mm)	C (mm)	D (mm)	E (mm)	P	Chiave			
PL3115*00000000	50	37	15	8	12	5	PK75058010000V2	6	190	Scatola e Blister
PL3117*00000000	70	51	22	12	15	5	PK75059010000V2	6	530	
PL3119*00000000	90	57	36	12	18	5	PK75059010000V2	6	770	

* 0 per la scatola, 1 per il blister

Lucchetti corazzati PL211

Caratteristiche

- Corpo in ottone rivestito da corazzina in acciaio carbonitrurato
- Gancio carbonitrurato
- N°3 chiavi
- KD e KA con cifratura obbligatoria
- Compatibile e Retrofit chiavi CORBIN Lucchetti PRIUM

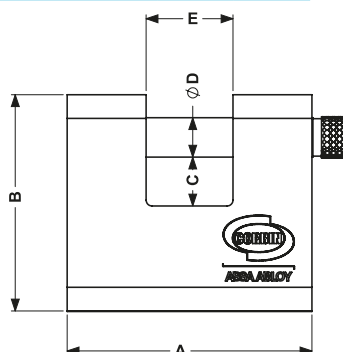

Codice	A (mm)	B (mm)	C (mm)	D (mm)	E (mm)	P	Chiave			
PL211600000000	62	55	12	10	22	5	PK75058010000V2	6	500	Scatola
PL211800000000	81	69	15	11	30	5	PK75059010000V2	6	815	
PL211900000000	91	75	19	12	36	5	PK75059010000V2	6	970	

Lucchetti speciali di sicurezza

Lucchetto speciale serie Y - Y120

Caratteristiche

- Corpo in ottone
- Arco in acciaio di Boron
- N°3 chiavi in ottone nichelato
- Per uso esterno
- Livello di sicurezza medio-alta
- Confezione in blister

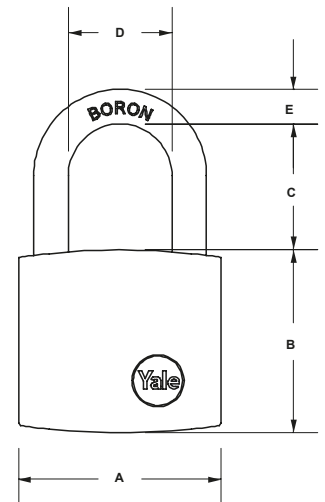

Blister

Codice	A (mm)	B (mm)	C (mm)	D (mm)	E (mm)	P		
YY120/40/125/1	41	37	25	20	7	5	1	250
YY120/50/127/1	70	46	26	25	9	5	1	440
YY120/50/163/1	62	52	34	35	10	5	1	490
YY120/60/135/1	62	52	34	35	10	5	1	610
YY120/70/141/1	71	52	41	40	11	5	1	740

Lucchetto speciale serie Y - Y121

Caratteristiche

- Corpo in ottone cromato satinato
- Arco in acciaio di Boron
- N°3 chiavi in ottone nichelato
- Per uso esterno
- Livello di sicurezza medio-alta
- Confezione in blister

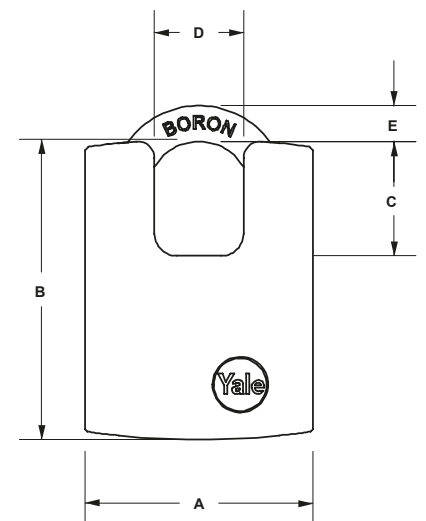

Blister

Codice	A (mm)	B (mm)	C (mm)	D (mm)	E (mm)	P		
YY121/40/125/1	47	62	7	22	21	5	1	268
YY121/50/132/1	58	77	9	23	24	5	1	485

Lucchetti speciali di sicurezza

3

Lucchetto speciale serie Y - Y122

Caratteristiche

- Corpo in ottone cromo satinato
- Arco in acciaio di Boron
- N°3 chiavi in ottone nichelato
- Per uso esterno
- Livello di sicurezza medio-alta
- Confezione in blister

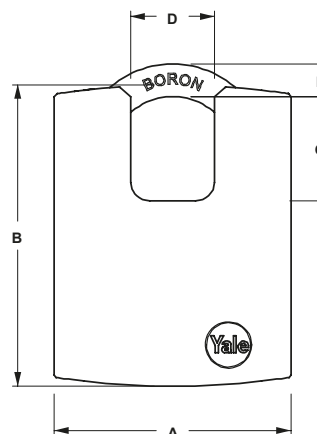

Codice	A (mm)	B (mm)	C (mm)	D (mm)	E (mm)	P	Pz.	gr.
YY122/50/123/1	51	65	7	23	19	5	1	400

Blister

Lucchetto speciale serie Y - Y210C

Caratteristiche

- Corpo in ottone cromato satinato
- Arco in acciaio di Boron
- N°3 chiavi in ottone nichelato
- Per uso esterno
- Livello di sicurezza medio-alta
- Confezione in blister

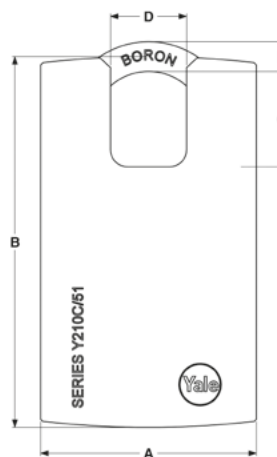

Codice	A (mm)	B (mm)	C (mm)	D (mm)	E (mm)	P	Pz.	gr.
YY210C/38/127/1	42	83	26	19	6	5	1	430
YY210C/51/127/1	51	88	27	20	10	5	1	600

Blister

Lucchetti speciali di sicurezza

Lucchetto speciale serie Y - Y124

Caratteristiche

- Corpo in ottone cromo satinato
- Arco in acciaio di Boron
- N°3 chiavi in ottone nichelato
- Per uso esterno
- Livello di sicurezza medio-alta
- Confezione in blister

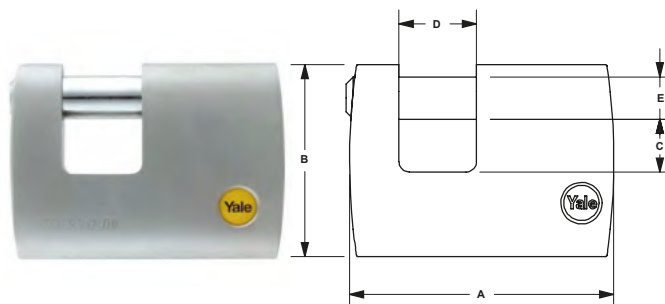

	Codice	A (mm)	B (mm)	C (mm)	D (mm)	E (mm)	P		
Blister	YY124/60/110/1	61	45	10	18	10	5	1	350
	YY124/70/115/1	75	56	15	22	12	5	1	580

Lucchetto speciale serie Y - Y210

Caratteristiche

- Corpo in ottone cromato satinato
- Arco in acciaio di Boron
- N°3 chiavi in ottone nichelato
- Per uso esterno
- Livello di sicurezza medio-alta
- Confezione in blister

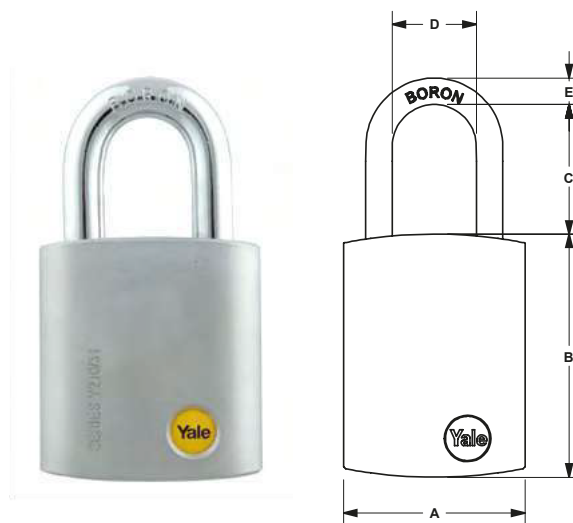

	Codice	A (mm)	B (mm)	C (mm)	D (mm)	E (mm)	P		
Blister	YY210/38/127/1	42	55	26	19	6	5	1	390
	YY210/51/127/1	51	55	27	20	10	5	1	510

Lucchetti speciali di sicurezza

3

Lucchetto speciale serie Y - Y220

Caratteristiche

- Corpo in ottone cromo satinato
- Arco in acciaio di Boron
- N°3 chiavi in ottone nichelato
- Per uso esterno
- Livello di sicurezza medio-alta
- Cover nero
- Tappino protettivo dell'ingresso chiave
- Confezione in blister

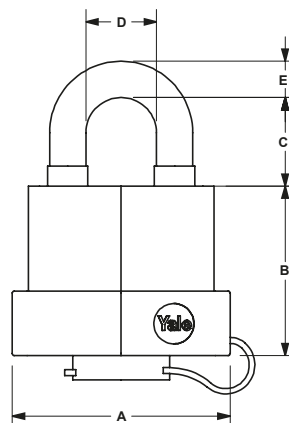

Codice	A (mm)	B (mm)	C (mm)	D (mm)	E (mm)	P		
YY220/51/118/1	53	49	22	18	6	5	1	328
YY220/61/123/1	62	54	26	21	10	5	1	529

Blister

Lucchetto speciale serie Y - Y879

Caratteristiche

- Corpo in zinco
- Arco in acciaio di Boron
- Per uso esterno
- Cover in plastica grigia e nera
- Sportello a protezione della combinazione e antipolvere
- Confezione in blister
- Combinazione

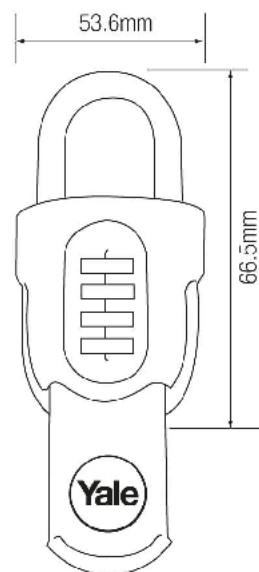

Codice	A (mm)	B (mm)	C (mm)	D (mm)	E (mm)	P		
YY879/55/130/1	42	83	26	19	6	-	1	-

Blister

Lucchetti speciali di sicurezza

Lucchetto speciale serie Y di alta sicurezza - Y300C

Caratteristiche

- Corpo in acciaio
- Arco in acciaio al molibdeno
- N°3 chiavi in ottone nichelato
- Per uso esterno
- Livello di sicurezza alta
- Confezione in blister

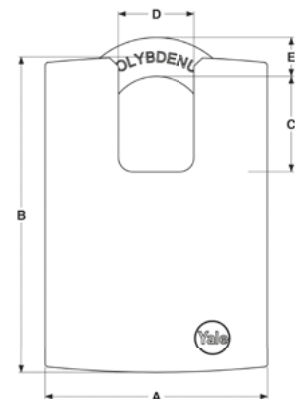

Codice	A (mm)	B (mm)	C (mm)	D (mm)	E (mm)	P	Pz.	gr.
YY300C/63/127/1	63	89,8	27	21,2	11	5	1	750

Blister

Lucchetto speciale serie Y - Y300

Caratteristiche

- Corpo in zinco
- Arco in acciaio di Boron
- Per uso esterno
- Cover in plastica grigia e nera
- Confezione in blister

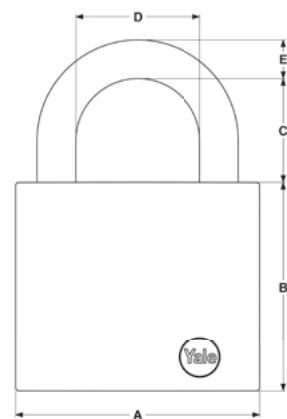

Codice	A (mm)	B (mm)	C (mm)	D (mm)	E (mm)	P	Pz.	gr.
YY300/63/127/1	63	54	27	32	10	5	1	660

Blister



Lucchetti speciali di sicurezza



Lucchetto speciale serie Y - Y330SS

Caratteristiche

- Corpo in acciaio inox
- Arco in acciaio inox
- N° 3 chiavi in ottone nichelato
- Per uso esterno
- Livello di sicurezza alta
- Confezione in blister

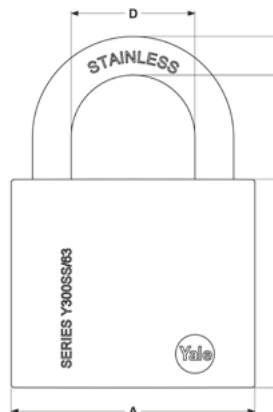

Codice	A (mm)	B (mm)	C (mm)	D (mm)	E (mm)	P		
Y300SS/63/127/1	63	54	27	32	10	5	1	660

Blister

Lucchetto speciale serie Y - Y90S

Caratteristiche

- Corpo in acciaio
- Arco in acciaio al molibdeno
- N° 3 chiavi in ottone nichelato
- Per uso esterno
- Livello di sicurezza alta
- Confezione in blister

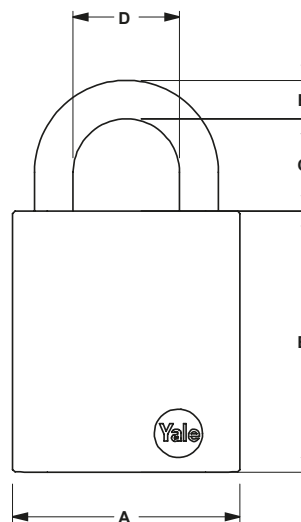

Codice	A (mm)	B (mm)	C (mm)	D (mm)	E (mm)	P		
YY90S/45/129/1	48	54	19	22	8	6	1	480

Blister



Lucchetti speciali di sicurezza

Lucchetto speciale serie Y - Y90SS

Caratteristiche

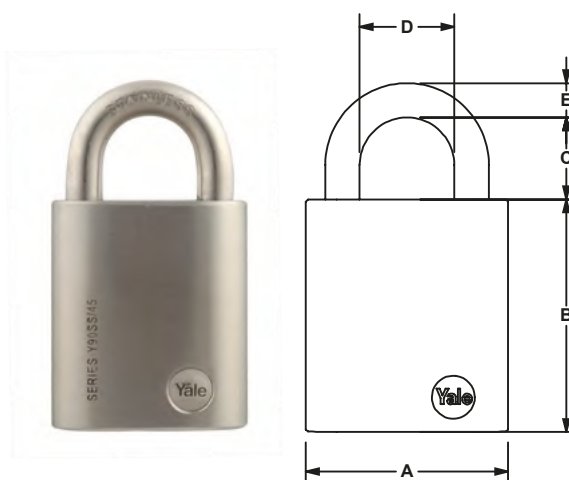
- Corpo in acciaio inox
- Arco in acciaio inox
- N° 3 chiavi in ottone nichelato
- Per uso esterno
- Livello di sicurezza alta
- Confezione in blister



	Codice	A (mm)	B (mm)	C (mm)	D (mm)	E (mm)	P		
Blister	YY90SS/45/129/1	47	54	19	22	8	6	1	470



Lucchetti da viaggio



Lucchetto da viaggio YP1

Caratteristiche

- Disponibile in 3 colori
- Consigliati per borse e valigie
- Confezione in blister
- Combinazione

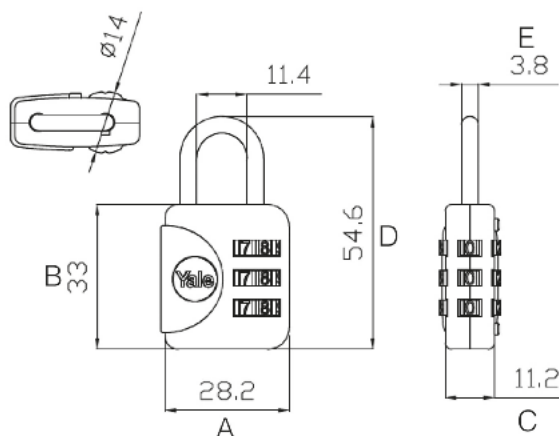

Codice	A (mm)	B (mm)	C (mm)	D (mm)	E (mm)	P		
YYP1/28/121/1G	28	33	11	54	3,8	-	6	-
YYP1/28/121/1R	28	33	11	54	3,8	-	6	-
YYP1/28/121/1Y	28	33	11	54	3,8	-	6	-

Blister

Lucchetto da viaggio YP2

Caratteristiche

- Disponibile in 3 colori
- Consigliati per borse e valigie
- Confezione in blister
- Combinazione

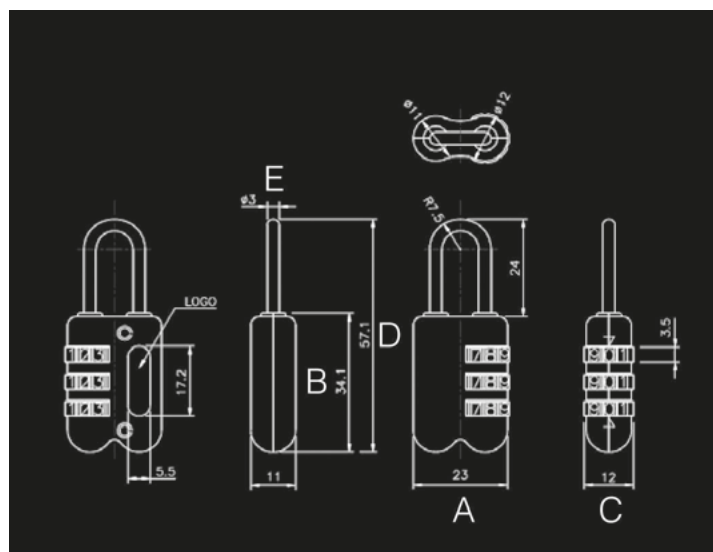

Codice	A (mm)	B (mm)	C (mm)	D (mm)	E (mm)	P		
YYP2/23/128/1G	23	34	12	57	3	-	6	-
YYP2/23/128/1R	23	34	12	57	3	-	6	-
YYP2/23/128/1Y	23	34	12	57	3	-	6	-

Blister

Lucchetti da viaggio

Lucchetto da viaggio con cavo metallico YR1

Caratteristiche

- Disponibile in 3 colori
- Consigliati per borse e valigie
- Confezione in blister
- Combinazione

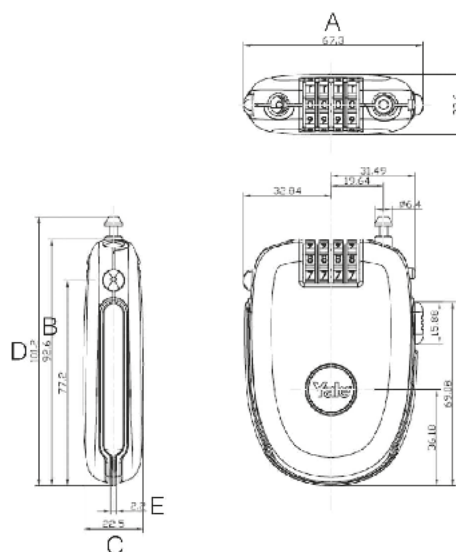

	Codice	A (mm)	B (mm)	C (mm)	D (mm)	E (mm)	P		
Blister	YYR1/64/3450/1	64	90	22	101	2,5	-	6	-

Lucchetto da viaggio con dispositivo TSA - YTL1

Caratteristiche

- Corpo in ABS
- Arco in Polipropilene
- Disponibile nei colori rosso e grigio
- Consigliati per borse e valigie
- Dotati di dispositivo Travel Security Administration (TSA)
- Dotati di dispositivo di ispezione
- Fascia di 2 metri di lunghezza
- Confezione in blister
- Combinazione
- Il TSA permette al personale di sicurezza aeroportuale di esaminare il contenuto bagaglio senza forzare il lucchetto

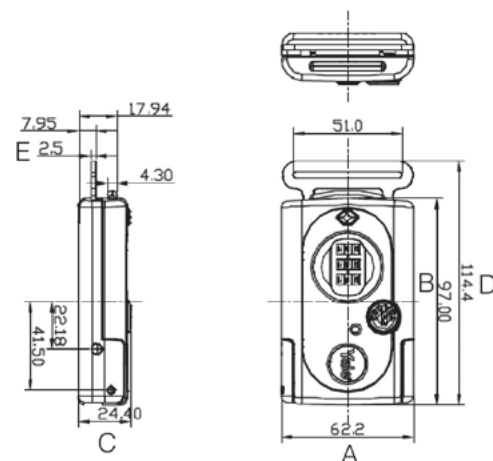

	Codice	A (mm)	B (mm)	C (mm)	D (mm)	E (mm)	P		
Blister	YYTL1/62/4/1G	62	97	22	114	2,5	-	6	-
	YYTL1/62/4/1R	62	97	22	114	2,5	-	6	-

Lucchetti da viaggio



Lucchetto da viaggio con dispositivo TSA - YTP1

Caratteristiche

- Corpo in zinco
- Arco in acciaio
- Consigliati per borse e valigie
- Dotati di dispositivo Travel Security Administration (TSA)
- Dotati di dispositivo di ispezione
- Confezione in blister
- Combinazione
- Il TSA permette al personale di sicurezza aeroportuale di esaminare il contenuto bagaglio senza forzare il lucchetto

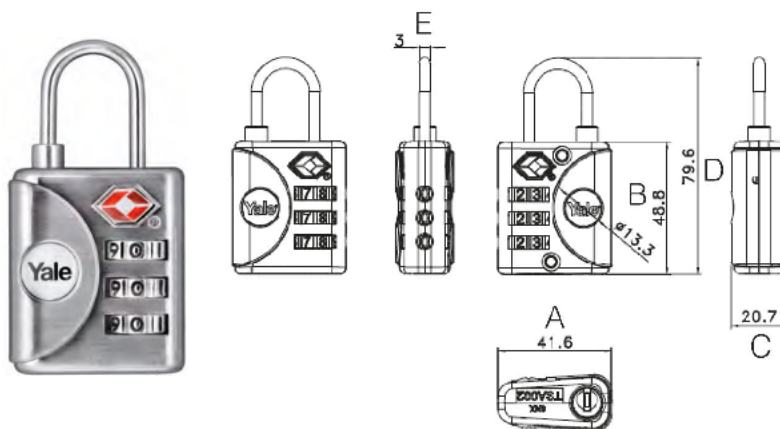

Codice	A (mm)	B (mm)	C (mm)	D (mm)	E (mm)	P		
YYTP1/32/119/1	42	49	21	79	3	-	6	-

Blister

Lucchetto da viaggio con dispositivo TSA - YTP2

Caratteristiche

- Corpo in zinco
- Arco in zinco
- Disponibile in 2 colori
- Consigliati per borse e valigie
- Dotati di dispositivo Travel Security Administration (TSA)
- Confezione in blister
- Combinazione
- Il TSA permette al personale di sicurezza aeroportuale di esaminare il contenuto bagaglio senza forzare il lucchetto

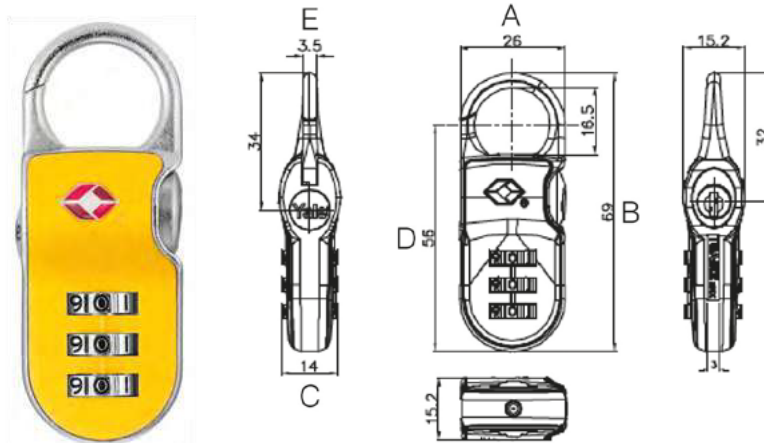

Codice	A (mm)	B (mm)	C (mm)	D (mm)	E (mm)	P		
YYTP2/26/216/1R	27	68	15	56	3,5	-	6	-
YYTP2/26/216/1Y	27	68	15	56	3,5	-	6	-

Blister



Lucchetti da viaggio

Lucchetto da viaggio con dispositivo TSA - YTP3

Caratteristiche

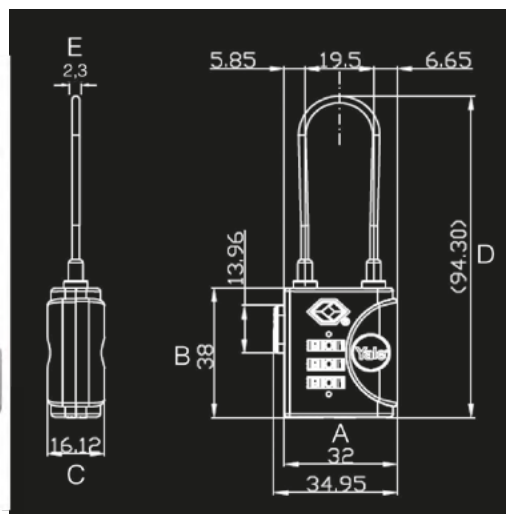
- Corpo in zinco
- Arco in acciaio
- Consigliati per borse e valigie
- Dotati di dispositivo Travel Security Administration (TSA)
- Confezione in blister
- Combinazione
- Il TSA permette al personale di sicurezza aeroportuale di esaminare il contenuto bagaglio senza forzare il lucchetto



Codice	A (mm)	B (mm)	C (mm)	D (mm)	E (mm)	P		
YYTP3/32/350/1	32	38	16	94	2,3	-	6	-

Blister



Mini lucchetti fashion





3

Lucchetto a combinazione Novelty - 28/2M/2P

Caratteristiche

- Corpo in zinco
- Disponibile in varie forme e colori
- Confezione in blister
- Combinazione



Codice	 pz.	 gr.
YY-NOVELTY-2B	5	-
YY-NOVELTY-2M	5	-
YY-NOVELTY-2P	5	-



Blister

Lucchetto a combinazione Novelty - 4B/4S

Caratteristiche

- Corpo in zinco
- Disponibile in varie forme e colori
- Confezione in blister
- Combinazione



Codice	 pz.	 gr.
YY-NOVELTY-4B	5	-
YY-NOVELTY-4S	5	-

Blister

Accessori

Coppia occhioli mobili

Caratteristiche

- Acciaio carbonitrurato e zincato





Codice	Confezione		
PAL400063000000	Scatola	6	460
Y0A160083080	Blister	6	460

Cravatte

Caratteristiche

- Acciaio carbonitrurato e zincato



Codice	mm	Chiave		
PAL240064000000	107x127x50,5	Scatola	6	450
Y0A160084080	107x127x50,5	Blister	4	450
PAL240065000000	147x167x50,5	Scatola	6	450
Y0A160085080	147x167x50,5	Blister	4	450

Campana squadra

Caratteristiche

- Acciaio zincato
- Rondella e bullone di fissaggio



Codice	mm	Confezione		
PAL44 00 46	-	-	1	-

Accessori

3

Gruppo occhioli a pavimento

Caratteristiche

- Perni in acciaio carbonitrurato/zincato
- Campana e ghiera in ottone



Codice	Confezione		
PAL400041000000	Scatola	1	1.143
YOA160091080	Blister	1	1.143
Y1600009111	Scatola	1	0.360

Gruppo occhioli a pavimento

Caratteristiche

- Staffa e perni in acciaio carbonitrurato/zincato
- Campana e ghiera in ottone



Codice	Confezione		
PAL400043000000	Scatola	1	1.975
YOA160093080	Blister	1	1.975

Coppia occhioli fissi

Caratteristiche

- Acciaio carbonitrurato e zincato



Codice	Confezione	Versione		
PAL400061000000	Scatola	Viti da 45 mm	6	280
YOA160081080	Blister	Viti da 45 mm	6	280
PAL400062000000	Scatola	Viti da 75 mm	6	320
YOA160082080	Blister	Viti da 75 mm	6	320

ASSA ABLOY is the global leader in door opening solutions, dedicated to satisfying end-user needs for security, safety and convenience

ASSA ABLOY

www.assaabloy.com

ASSA ABLOY Italia S.p.A.
Tel.: +39 051 6812411
Fax: +39 051 827486

info@assaabloy.it
www.assaabloy.it



Cod. HF02008 / 01-2018