



CATALOGO
2014



Meroni[®]
serrature



PROXIMA

**SERIE
NPXA**

PROXIMA **SUPPORTO ELETTRONICO PER PREMIAPRI** *CONTACTLESS ELECTRONIC SYSTEM*

PROXIMA CON PRIVACY *PROXIMA WITH PRIVACY*



NPXA	Supporto elettronico per PremiApri	<i>PremiApri contactless electronic system</i>
FINITURE		
NA	Verniciato argento	<i>Silver coating</i>
BO	Verniciato bianco	<i>White coating</i>
NE	Verniciato nero	<i>Black coating</i>
3	Verniciato oro (US3)	<i>Gold coating (US3)</i>
CONFIGURAZIONE		
40	Per Hotel	<i>For Hotel</i>
CONFEZIONI		
B	Con batteria	<i>With battery</i>
	Senza batteria	<i>Without battery</i>
	Scatola da 1 pz	<i>Boxed in 1's</i>
Si abbina con i pomoli:		
	Combina K40	<i>Combina K40</i>
	Forma F40	<i>Forma F40</i>
	Nova N40	<i>Nova N40</i>

PROXIMA SENZA PRIVACY *PROXIMA WITHOUT PRIVACY*



NPXA	Supporto elettronico per PremiApri	<i>PremiApri contactless electronic system</i>
FINITURE		
NA	Verniciato argento	<i>Silver coating</i>
BO	Verniciato bianco	<i>White coating</i>
NE	Verniciato nero	<i>Black coating</i>
3	Verniciato oro (US3)	<i>Gold coating (US3)</i>
CONFIGURAZIONE		
47	Per ufficio	<i>For office</i>
CONFEZIONI		
B	Con batteria	<i>With battery</i>
	Senza batteria	<i>Without battery</i>
	Scatola da 1 pz	<i>Boxed in 1's</i>
Si abbina con i pomoli:		
	Combina K47	<i>Combina K47</i>
	Forma F47	<i>Forma F47</i>
	Nova N47	<i>Nova N47</i>

CONTROLLO ACCESSI PER HOTEL HOTEL ACCESS CONTROL



NPXU	Controllo accessi per hotel	Hotel access control system
FINITURE		FINISHES
NA	Verniciato argento	Silver coating
BO	Verniciato bianco	White coating
NE	Verniciato nero	Black coating
3	Verniciato oro (US3)	Gold coating (US3)
CONFIGURAZIONE		CONFIGURATION
40	Per hotel	For hotel
Con batteria		With battery
B	Senza batteria	Without battery
CONFEZIONI		PACKAGING
	Scatola da 1 pz	Boxed in 1's
Si abbina con i pomoli:		Combinable with knobs:
	Combina K40	Combina K40
	Forma F40	Forma F40
	Nova N40	Nova N40



NPXPRGSWP	Letture e programmatore da banco	Dual interface card reader/programmer	€ 1.480,00
	Software di programmazione per hotel	Hotel property management system	

Da usare solo con NPXU

Only use with NPXU

CARTE PER SISTEMA NPXA - NPXU CARDS FOR NPXA - NPXU SYSTEMS

NGRCAPHO	Kit carte di programmazione per Hotel	Programming card kit for Hotel
	1 Carta "Assegna codice impianto"	1 Card "Assign ID Code"
	1 Carta "Programma nuova carta"	1 Card "Program new card"
	1 Carta "Stato batteria"	1 Card "Battery status"
	1 Carta "Elimina carta"	1 Card "Delete card"
NGRCAPOF	Kit carte di programmazione per ufficio	Programming card kit for offices
	1 Carta "Assegna codice impianto"	1 Card "Assign ID Code"
	1 Carta "Programma nuova carta"	1 Card "Program new card"
	1 Carta "Stato batteria"	1 Card "Battery status"
NGRCASER	Kit carte di servizio	Service card kit
	1 Carta "Carta di servizio"	1 Card "Service card"
	1 Carta "Elimina carta di servizio"	1 Card "Delete service card"
NGRCAUOF	Kit utente ufficio	Service card kit
	1 Carta "Utente"	1 Card "User"
	1 Carta "Elimina carta"	1 Card "Delete card"
NCAMF1UT	Carta singolo utente	Single user card
	1 Carta "Utente"	1 Card "User"

**SERIE
 NPXA**

K40 PER HOTEL FOR HOTEL

**SOLO CON PROXIMA
 ONLY WITH PROXIMA**

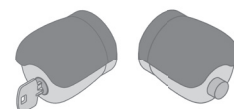

esterno
 outside

interno
 inside

FUNZIONE

Bloccabile o sbloccabile dall'esterno con chiave.
 Pomolo interno con bottone.
Con dispositivo di emergenza per lo sbloccaggio automatico.

FUNCTION

Locked or unlocked from outside by key.
 Inside knob with button.
With emergency device for automatic release.

K40	40/COMBINA senza scrocco senza controbordo	40/COMBINA without latch, without striking plate
FINITURE CORPO		BODY FINISHES
BO	Verniciato bianco	White coating
NA	Verniciato argento	Silver coating
NE	Verniciato nero	Black coating
15	Nickel opaco (US15)	Matt nickel (US15)
26	Cromo lucido (US26)	Polish chrome (US26)
6D	Cromo opaco (US26D)	Matt chrome (US26D)
3	Oro lucido (US3)	Polish gold (US3)
1	Pomolo inferiore in metallo	Knob body in metal
FINITURE TASTO		UPPER CAPS FINISHES
ST	Senza tasto	Without upper caps
BO	Kelon bianco	Kelon white
CG	Kelon grigio chiaro	Kelon light grey
DG	Kelon grigio scuro	Kelon dark grey
NE	Kelon nero	Kelon black
RA	Rivestito acero	Maple texture
RW	Rivestito wengè	Wengè texture
AV	Verniciato aragosta	Red lobster coating
AZ	Verniciato azzurro	Light blue coating
LB	Verniciato blu gomma	Rubber finish, blue coating
VA	Verniciato verde acido	Acid green coating
26	Cromo lucido (US26)	Polish chrome (US26)
3	Oro lucido (US3)	Polish gold (US3)
SCROCCO		TUBULAR LATCH
S	Senza Scrocco	Without tubular latch
	TB-60 entrata mm 60 (standard)	TB-60 backset 2 23/64" (standard)
T7	TB-70 entrata mm 70	TB-70 backset 2 3/4"
T8	TB-80 entrata mm 80	TB-80 backset 3 5/32"
T9	TB-127 entrata mm 127	TB-127 backset 5 1/64"
A6	TBA-60 antiscasso, entrata mm 60	TBA-60 security device, backset 2 23/64"
A7	TBA-70 antiscasso, entrata mm 70	TBA-70 security device, backset 2 3/4"
A8	TBA-80 antiscasso, entrata mm 80	TBA-80 security device, backset 3 5/32"
06	TB-060 bordo in acciaio entrata mm 60	TB-060 steel edge, backset 2 23/64"
07	TB-070 bordo in acciaio entrata mm 70	TB-070 steel edge, backset 2 3/4"
08	TB-080 bordo in acciaio entrata mm 80	TB-080 steel edge, backset 3 5/32"
6M	TBM-60 bordo mm 25 tondo magnetico	TBM-60 edge backset 2 23/64" magnetic
7M	TBM-70 bordo mm 25 tondo magnetico	TBM-70 edge backset 2 3/4" magnetic

K40 PER HOTEL FOR HOTEL

SOLO CON PROXIMA
ONLY WITH PROXIMA

SERIE
NPXA

PROXIMA

	BORDO SCROCCO		LATCH FOREND
	Quadro		Squared
T	Tondo		Round
	CIFRATURE		KEY-CHANGES
	KD chiavi differenti		KD keyed differently
A	KA chiavi uguali		KD keyed alike
M	MK chiave maestra		MK master key
G	GMK chiave maestra generale		GMK general master key
K	GGMK chiave gran maestra generale		GGMK grand general master key
	SPESSORI PORTE		DOOR THICKNESS
	mm 32 ÷ 60		1 17/64" ÷ 2 23/64"
+	mm 60 ÷ 70		2 23/64" ÷ 2 3/4"
>	> mm 70		> 2 3/4"
	CONTROBORDI		STRIKING PLATE
	Senza controbordo		Without striking plate
	P875 quadro (standard)		P875 square (standard)
T	P875/T arrotondato		P875/T round-edge
1	P896 rifilato		P896 without forend
1T	P896/T rifilato arrotondato		P896/T without forend, round-edge
91	P1291/R nylon nero, regolabile		P1291/R adjustable, black nylon

**SERIE
 NPXA**

K47 PER UFFICIO FOR OFFICE

**SOLO CON PROXIMA
 ONLY WITH PROXIMA**

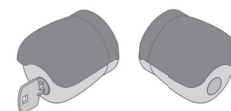

esterno
 outside

interno
 inside

FUNZIONE

Bloccabile o sbloccabile dall'esterno con chiave.
 Tasto interno sempre azionabile.

FUNCTION

Locked or unlocked from outside by key.
 Inside upper caps for free passage.

K47	47/COMBINA senza scrocco senza controbordo	47/COMBINA without latch, without striking plate
FINITURE CORPO		BODY FINISHES
BO	Verniciato bianco	White coating
NA	Verniciato argento	Silver coating
NE	Verniciato nero	Black coating
15	Nickel opaco (US15)	Matt nickel (US15)
26	Cromo lucido (US26)	Polish chrome (US26)
6D	Cromo opaco (US26D)	Matt chrome (US26D)
3	Oro lucido (US3)	Polish gold (US3)
1	Pomolo inferiore in metallo	Knob body in metal
FINITURE TASTO		UPPER CAPS FINISHES
ST	Senza tasto	Without upper caps
BO	Kelon bianco	Kelon white
CG	Kelon grigio chiaro	Kelon light grey
DG	Kelon grigio scuro	Kelon dark grey
NE	Kelon nero	Kelon black
RA	Rivestito acero	Maple texture
RW	Rivestito wengè	Wengè texture
AV	Verniciato aragosta	Red lobster coating
AZ	Verniciato azzurro	Light blue coating
LB	Verniciato blu gomma	Rubber finish, blue coating
VA	Verniciato verde acido	Acid green coating
26	Cromo lucido (US26)	Polish chrome (US26)
3	Oro lucido (US3)	Polish gold (US3)
SCROCCO		TUBULAR LATCH
S	Senza Scrocco	Without tubular latch
	TB-60 entrata mm 60 (standard)	TB-60 backset 2 23/64" (standard)
T7	TB-70 entrata mm 70	TB-70 backset 2 3/4"
T8	TB-80 entrata mm 80	TB-80 backset 3 5/32"
T9	TB-127 entrata mm 127	TB-127 backset 5 1/64"
A6	TBA-60 antiscasso, entrata mm 60	TBA-60 security device, backset 2 23/64"
A7	TBA-70 antiscasso, entrata mm 70	TBA-70 security device, backset 2 3/4"
A8	TBA-80 antiscasso, entrata mm 80	TBA-80 security device, backset 3 5/32"
06	TB-060 bordo in acciaio entrata mm 60	TB-060 steel edge, backset 2 23/64"
07	TB-070 bordo in acciaio entrata mm 70	TB-070 steel edge, backset 2 3/4"
08	TB-080 bordo in acciaio entrata mm 80	TB-080 steel edge, backset 3 5/32"
6M	TBM-60 bordo mm 25 tondo magnetico	TBM-60 edge backset 2 23/64" magnetic
7M	TBM-70 bordo mm 25 tondo magnetico	TBM-70 edge backset 2 3/4" magnetic

K47 PER UFFICIO FOR OFFICE

SOLO CON PROXIMA
ONLY WITH PROXIMA

SERIE
NPXA

PROXIMA

	BORDO SCROCCO		LATCH FOREND
	Quadro		Squared
T	Tondo		Round
	CIFRATURE		KEY-CHANGES
	KD chiavi differenti		KD keyed differently
A	KA chiavi uguali		KD keyed alike
M	MK chiave maestra		MK master key
G	GMK chiave maestra generale		GMK general master key
K	GGMK chiave gran maestra generale		GGMK grand general master key
	SPESSORI PORTE		DOOR THICKNESS
	mm 32 ÷ 60		1 17/64" ÷ 2 23/64"
+	mm 60 ÷ 70		2 23/64" ÷ 2 3/4"
>	> mm 70		> 2 3/4"
	CONTROBORDI		STRIKING PLATE
	Senza controbordo		Without striking plate
	P875 quadro (standard)		P875 square (standard)
T	P875/T arrotondato		P875/T round-edge
1	P896 rifilato		P896 without forend
1T	P896/T rifilato arrotondato		P896/T without forend, round-edge
91	P1291/R nylon nero, regolabile		P1291/R adjustable, black nylon

**SERIE
 NPXA**

**F40 PER HOTEL
 FOR HOTEL**

**SOLO CON PROXIMA
 ONLY WITH PROXIMA**

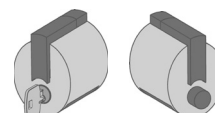

esterno
 outside

interno
 inside

FUNZIONE

Bloccabile o sbloccabile dall'esterno con chiave.
 Pomolo interno con bottone.
Con dispositivo di emergenza per lo sbloccaggio automatico.

FUNCTION

Locked or unlocked from outside by the key.
 outside knob with button.
With emergency device for automatic release.

F40 40/FORMA senza scrocco senza controbordo

40/FORMA without latch, without striking plate

FINITURE

3	Oro lucido (US3)
4K	Oro opaco (24K)
26	Cromo lucido (US26)
6D	Cromo opaco (US26D)
15	Nickel opaco (US15)
NA	Verniciato argento
BO	Polimero bianco
GR	Polimero grigio
NE	Polimero nero

FINISHES

Polish gold (US3)
Matt gold (24K)
Polish chrome (US26)
Matt chrome (US26D)
Matt nickel (US15)
Silver coating
Polymer white
Polymer grey
Polymer black

SCROCCO

S	Senza scrocco
	TB-60 entrata mm 60 (standard)
T7	TB-70 entrata mm 70
T8	TB-80 entrata mm 80
T9	TB-127 entrata mm 127
A6	TBA-60 antiscasso, entrata mm 60
A7	TBA-70 antiscasso, entrata mm 70
A8	TBA-80 antiscasso, entrata mm 80
06	TB-060 bordo in acciaio, entrata mm 60
07	TB-070 bordo in acciaio, entrata mm 70
08	TB-080 bordo in acciaio, entrata mm 80
6M	TBM-60 bordo mm 25 tondo magnetico
7M	TBM-70 bordo mm 25 tondo magnetico

TUBULAR LATCH

Without tubular latch
TB-60 backset 2 23/64" (standard)
TB-70 backset 2 3/4"
TB-80 backset 3 5/32"
TB-127 backset 5 1/64"
TBA-60 security device, backset 2 23/64"
TBA-70 security device, backset 2 3/4"
TBA-80 security device, backset 3 5/32"
TB-060 steel edge, backset 2 23/64"
TB-070 steel edge, backset 2 3/4"
TB-080 steel edge, backset 3 5/32"
TBM-60 edge backset 2 23/64" magnetic
TBM-70 edge backset 2 3/4" magnetic

BORDO SCROCCO

	Quadro
T	Tondo

LATCH FOREND

Squared
Round

Larghezza mm 22

Width 55/64"

CIFRATURE

	KD chiavi differenti
A	KA chiavi uguali
M	MK chiave maestra
G	GMK chiave maestra generale
K	GGMK chiave gran maestra generale

KEY-CHANGES

KD keyed differently
KA keyed alike
MK master key
GMK general master key
GGMK grand general master key

SPessori PORTE

	mm 32 ÷ 60
+	mm 60 ÷ 70
>	> mm 70

DOOR THICKNESS

1 17/64" ÷ 2 23/64"
2 23/64" ÷ 2 3/4"
> 2 3/4"

CONTROBORDI

C	Senza controbordo
	P875 quadro
T	P875/T arrotondato
1	P896 rifilato
1T	P896/T rifilato arrotondato
91	P1291/R nylon nero regolabile

STRIKING PLATE

Without striking plate
P875 square
P875/T round-edge
P896 without forend
P896/T without forend, round-edge
P1291/R adjustable, black nylon

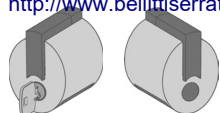

esterno
outside

interno
inside

F47 PER UFFICIO FOR OFFICE

SOLO CON PROXIMA
ONLY WITH PROXIMA

SERIE
NPXA

PROXIMA

FUNZIONE

Bloccabile o sbloccabile dall'esterno con chiave.
 Pulsante interno sempre azionabile.

FUNCTION

Locked or unlocked from outside by key.
 Inside push-button for free passage.

F47 47/FORMA senza scrocco senza controbordo

47/FORMA without latch, without striking plate

FINITURE

3	Oro lucido (US3)
4K	Oro opaco (24K)
26	Cromo lucido (US26)
6D	Cromo opaco (US26D)
15	Nickel opaco (US15)
NA	Verniciato argento
BO	Polimero bianco
GR	Polimero grigio
NE	Polimero nero

FINISHES

Polish gold (US3)
Matt gold (24K)
Polish chrome (US26)
Matt chrome (US26D)
Matt nickel (US15)
Silver coating
Polymer white
Polymer grey
Polymer black

SCROCCO

Senza scrocco

S	Senza scrocco
T7	TB-60 entrata mm 60 (standard)
T8	TB-70 entrata mm 70
T9	TB-80 entrata mm 80
A6	TB-127 entrata mm 127
A7	TBA-60 antiscasso, entrata mm 60
A8	TBA-70 antiscasso, entrata mm 70
06	TBA-80 antiscasso, entrata mm 80
07	TB-060 bordo in acciaio, entrata mm 60
08	TB-070 bordo in acciaio, entrata mm 70
6M	TB-080 bordo in acciaio, entrata mm 80
7M	TBM-60 bordo mm 25 tondo magnetico
	TBM-70 bordo mm 25 tondo magnetico

TUBULAR LATCH

Without tubular latch

TB-60	backset 2 23/64" (standard)
TB-70	backset 2 3/4"
TB-80	backset 3 5/32"
TB-127	backset 5 1/64"
TBA-60	security device, backset 2 23/64"
TBA-70	security device, backset 2 3/4"
TBA-80	security device, backset 3 5/32"
TB-060	steel edge, backset 2 23/64"
TB-070	steel edge, backset 2 3/4"
TB-080	steel edge, backset 3 5/32"
TBM-60	edge backset 2 23/64" magnetic
TBM-70	edge backset 2 3/4" magnetic

BORDO SCROCCO

Quadro
 Tondo

LATCH FOREND

Squared
 Round

Larghezza mm 22

Width 55/64"

CIFRATURE

A	KD chiavi differenti
M	KA chiavi uguali
G	MK chiave maestra
K	GMK chiave maestra generale
	GGMK chiave gran maestra generale

KEY-CHANGES

KD	keyed differently
KA	keyed alike
MK	master key
GMK	general master key
GGMK	grand general master key

SPessori PORTE

mm 32 ÷ 60
 + mm 60 ÷ 70
 > mm 70

DOOR THICKNESS

1 17/64" ÷ 2 23/64"
 2 23/64" ÷ 2 3/4"
 > 2 3/4"

CONTROBORDI

Senza controbordo
P875 quadro
T P875/T arrotondato
1 P896 rifilato
1T P896/T rifilato arrotondato
91 P1291/R nylon nero regolabile

STRIKING PLATE

Without striking plate
P875 square
P875/T round-edge
P896 without forend
P896/T without forend, round-edge
P1291/R adjustable, black nylon

**SERIE
 NPXA**

N40 PER HOTEL FOR HOTEL

**SOLO CON PROXIMA
 ONLY WITH PROXIMA**

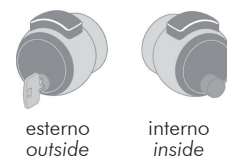

FUNZIONE

Bloccabile o sbloccabile dall'esterno con chiave.
 Pomolo interno con girevole.

FUNCTION

Locked or unlocked from outside by key.
 Inside knob with turnthumb.

N40 40/NOVA senza scrocco senza controbordo

40/NOVA without latch, without striking plate

FINITURE

BO	Verniciato bianco
NA	Verniciato argento
NE	Verniciato nero
PE	Verniciato grigio perla
3	Ottone lucido (US3)
4	Ottone satinato (US4)
26	Ottone cromo lucido (US26)
6D	Ottone cromo satinato
2B	Acciaio inox satinato

FINISHES

White coating
Silver coating
Black coating
Pearl grey coating
Polish brass (US3)
Satin brass (US4)
Polish chrome brass (US26)
Satin chrome brass (US26D)
Satin stainless steel

G Adatto per GL

Suitable to GL

SCROCCO

S	Senza scrocco
T7	TB-60 entrata mm 60 (standard)
T8	TB-70 entrata mm 70
T9	TB-80 entrata mm 80
A6	TB-127 entrata mm 127
A7	TBA-60 antiscasso, entrata mm 60
A8	TBA-70 antiscasso, entrata mm 70
06	TBA-80 antiscasso, entrata mm 80
07	TB-060 bordo in acciaio entrata mm 60
08	TB-070 bordo in acciaio, entrata mm 70
6M	TB-080 bordo in acciaio, entrata mm 80
7M	TBM-60 bordo mm 25 tondo magnetico
	TBM-70 bordo mm 25 tondo magnetico

TUBULAR LATCH

Without tubular latch
TB-60 backset 2 23/64" (standard)
TB-70 backset 2 3/4"
TB-80 backset 3 5/32"
TB-127 backset 5 1/64"
TBA-60 security device, backset 2 23/64"
TBA-70 security device, backset 2 3/4"
TBA-80 security device, backset 3 5/32"
TB-060 steel edge, backset 2 23/64"
TB-070 steel edge, backset 2 3/4"
TB-080 steel edge, backset 3 5/32"
TBM-60 edge backset 2 23/64" magnetic
TBM-70 edge backset 2 3/4" magnetic

BORDO SCROCCO

T	Quadro
	Tondo

LATCH FOREND

Squared
Round

Larghezza mm 22

Width 55/64"

CIFRATURE

A	KD chiavi differenti
M	KA chiavi uguali
G	MK chiave maestra
K	GMK chiave maestra generale
	GGMK chiave gran maestra generale

KEY-CHANGES

KD keyed differently
KA keyed alike
MK master key
GMK general master key
GGMK grand general master key

SPessori PORTE

+	mm 32 ÷ 60
>	mm 60 ÷ 70
	> mm 70

DOOR THICKNESS

1 17/64" ÷ 2 23/64"
2 23/64" ÷ 2 3/4"
> 2 3/4"

CONTROBORDI

C	Senza controbordo
T	P875 standard, quadro
1	P875/T arrotondato
1T	P896 refillato
91	P896/T refillato, arrotondato
	P1291/R nylon nero regolabile

STRIKING PLATE

Without striking plate
P875 standard, squared
P875/T round-edge
P896 without forend
P896/T without forend, round-edge
P1291/R adjustable, black nylon



esterno
outside



interno
inside

N47 PER UFFICIO FOR OFFICE

SOLO CON PROXIMA
ONLY WITH PROXIMA

SERIE
NPXA

PROXIMA

FUNZIONE

Bloccabile o sbloccabile dall'esterno con chiave.
 Pulsante interno sempre azionabile.

FUNCTION

Locked or unlocked from outside by key.
 Inside push-button for free passage.

N47 47/NOVA senza scrocco senza controbordo

47/NOVA without latch, without striking plate

FINITURE

BO	Verniciato bianco
NA	Verniciato argento
NE	Verniciato nero
PE	Verniciato grigio perla
3	Ottone lucido (US3)
4	Ottone satinato (US4)
26	Ottone cromo lucido (US26)
6D	Ottone cromo satinato
2B	Acciaio inox satinato

FINISHES

White coating
Silver coating
Black coating
Pearl grey coating
Polish brass (US3)
Satin brass (US4)
Polish chrome brass (US26)
Satin chrome brass (US26D)
Satin stainless steel

G Adatto per GL

Suitable to GL

SCROCCO

S	Senza scrocco
T7	TB-60 entrata mm 60 (standard)
T8	TB-70 entrata mm 70
T9	TB-80 entrata mm 80
A6	TB-127 entrata mm 127
A7	TBA-60 antiscasso, entrata mm 60
A8	TBA-70 antiscasso, entrata mm 70
06	TBA-80 antiscasso, entrata mm 80
07	TB-060 bordo in acciaio entrata mm 60
08	TB-070 bordo in acciaio, entrata mm 70
6M	TB-080 bordo in acciaio, entrata mm 80
7M	TBM-60 bordo mm 25 tondo magnetico
	TBM-70 bordo mm 25 tondo magnetico

TUBULAR LATCH

Without tubular latch
TB-60 backset 2 23/64" (standard)
TB-70 backset 2 3/4"
TB-80 backset 3 5/32"
TB-127 backset 5 1/64"
TBA-60 security device, backset 2 23/64"
TBA-70 security device, backset 2 3/4"
TBA-80 security device, backset 3 5/32"
TB-060 steel edge, backset 2 23/64"
TB-070 steel edge, backset 2 3/4"
TB-080 steel edge, backset 3 5/32"
TBM-60 edge backset 2 23/64" magnetic
TBM-70 edge backset 2 3/4" magnetic

BORDO SCROCCO

T	Quadro
	Tondo

LATCH FOREND

Squared
Round

Larghezza mm 22

Width 55/64"

CIFRATURE

A	KD chiavi differenti
M	KA chiavi uguali
G	MK chiave maestra
K	GMK chiave maestra generale
	GGMK chiave gran maestra generale

KEY-CHANGES

KD keyed differently
KA keyed alike
MK master key
GMK general master key
GGMK grand general master key

SPessori PORTE

	mm 32 ÷ 60
+	mm 60 ÷ 70
>	> mm 70

DOOR THICKNESS

1 17/64" ÷ 2 23/64"
2 23/64" ÷ 2 3/4"
> 2 3/4"

CONTROBORDI

C	Senza controbordo
T	P875 standard, quadro
1	P875/T arrotondato
1T	P896 refilato
91	P896/T refilato, arrotondato
	P1291/R nylon nero regolabile

STRIKING PLATE

Without striking plate
P875 standard, squared
P875/T round-edge
P896 without forend
P896/T without forend, round-edge
P1291/R adjustable, black nylon

info e preventivi
<http://www.bellittiserrature.it/contact.asp>

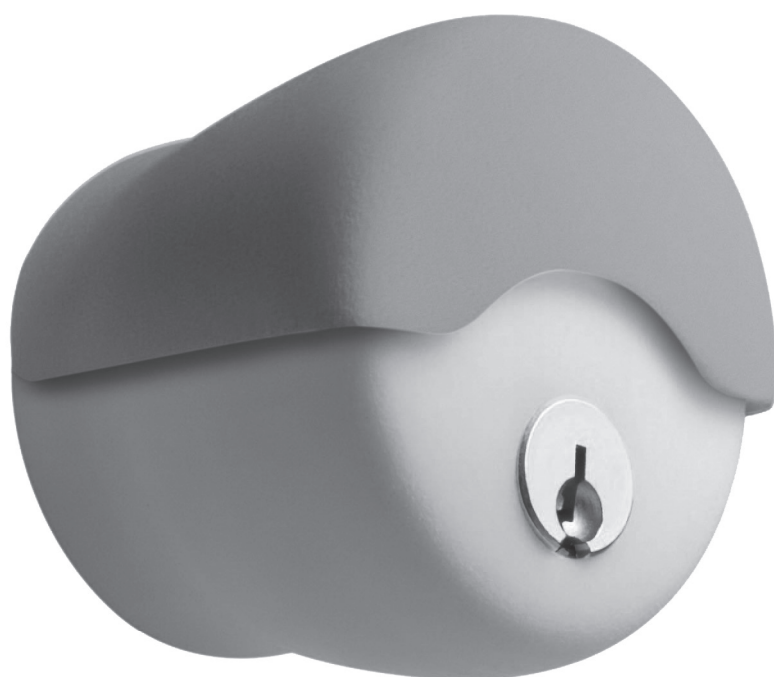

COMBINA

SERIE
K

K11 PER LOCALI DI PASSAGGIO FOR PASSAGEWAYS

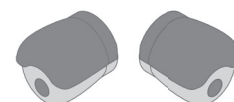

esterno
 outside

interno
 inside

FUNZIONE

Entrambi i tasti sono sempre azionabili

FUNCTION

Outside and inside upper caps for free passage.

K11	11/COMBINA senza scrocco senza controbordo	11/COMBINA without latch, without striking plate
	FINITURE CORPO	BODY FINISHES
BO	Verniciato bianco	White coating
NA	Verniciato argento	Silver coating
NE	Verniciato nero	Black coating
15	Nickel opaco (US15)	Matt nickel (US15)
26	Cromo lucido (US26)	Polish chrome (US26)
6D	Cromo opaco (US26D)	Matt chrome (US26D)
3	Oro lucido (US3)	Polish gold (US3)
CG	Grigio chiaro (polimero antibatterico)	Light grey (antibacterial polymer)
1	Pomolo inferiore in metallo	Knob body in metal
	FINITURE TASTO	UPPER CAPS FINISHES
ST	Senza tasto	Without upper caps
BO	Kelon bianco	Kelon white
CG	Kelon grigio chiaro	Kelon light grey
DG	Kelon grigio scuro	Kelon dark grey
NE	Kelon nero	Kelon black
RA	Rivestito acero	Maple texture
RW	Rivestito wengè	Wengè texture
AV	Verniciato aragosta	Red lobster coating
AZ	Verniciato azzurro	Light blue coating
LB	Verniciato blu gomma	Rubber finish, blue coating
VA	Verniciato verde acido	Acid green coating
26	Cromo lucido (US26)	Polish chrome (US26)
3	Oro lucido (US3)	Polish gold (US3)
ABO	Bianco (polimero antibatterico)	White (antibacterial polymer)
	SCROCCO	TUBULAR LATCH
S	Senza Scrocco	Without tubular latch
	TB-60 entrata mm 60 (standard)	TB-60 backset 2 23/64" (standard)
T7	TB-70 entrata mm 70	TB-70 backset 2 3/4"
T8	TB-80 entrata mm 80	TB-80 backset 3 5/32"
T9	TB-127 entrata mm 127	TB-127 backset 5 1/64"
A6	TBA-60 antiscasso, entrata mm 60	TBA-60 security device, backset 2 23/64"
A7	TBA-70 antiscasso, entrata mm 70	TBA-70 security device, backset 2 3/4"
A8	TBA-80 antiscasso, entrata mm 80	TBA-80 security device, backset 3 5/32"
O6	TB-060 bordo in acciaio entrata mm 60	TB-060 steel edge, backset 2 23/64"
O7	TB-070 bordo in acciaio entrata mm 70	TB-070 steel edge, backset 2 3/4"
O8	TB-080 bordo in acciaio entrata mm 80	TB-080 steel edge, backset 3 5/32"
6M	TBM-60 bordo mm 25 tondo magnetico	TBM-60 edge backset 2 23/64" magnetic
7M	TBM-70 bordo mm 25 tondo magnetico	TBM-70 edge backset 2 3/4" magnetic

K11 PER LOCALI DI PASSAGGIO FOR PASSAGEWAYS

SERIE
K

COMBINA

BORDO SCROCCO	LATCH FOREND
T Quadro Tondo	Squared Round
Larghezza mm 22	With 55/64"
SPESSORI PORTE	DOOR THICKNESS
mm 32 ÷ 60	1 17/64" ÷ 2 23/64"
+ mm 60 ÷ 70	2 23/64" ÷ 2 3/4"
> > mm 70	> 2 3/4"
CONTROBORDI	STRIKING PLATE
Senza controbordo	Without striking plate
C P875 quadro (standard)	P875 square (standard)
T P875/T arrotondato	P875/T round-edge
1 P896 refilato	P896 without forend
1T P896/T refilato arrotondato	P896/T without forend, round-edge
91 P1291/R nylon nero, regolabile	P1291/R adjustable, black nylon

SERIE
K

K12 PER BAGNI FOR BATHROOMS

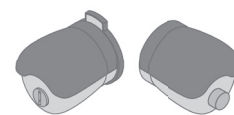

esterno
outside

interno
inside

FUNZIONE

Apertura esterna con chiave d'emergenza, moneta, cacciavite, o qualsiasi attrezzo simile.

Pomolo interno con bottone che aziona il segnalatore di occupato.

Con dispositivo di emergenza per lo sbloccaggio automatico.

FUNCTION

Locked from outside by emergency key, coin, screwdriver or any other similar tool.

Inside knob with button acting on occupancy indicator.

With emergency device for automatic release.

K12

12/COMBINA senza scrocco senza controbordo

12/COMBINA without latch, without striking plate

FINITURE CORPO

BODY FINISHES

BO

Verniciato bianco

White coating

NA

Verniciato argento

Silver coating

NE

Verniciato nero

Black coating

15

Nickel opaco (US15)

Matt nickel (US15)

26

Cromo lucido (US26)

Polish chrome (US26)

6D

Cromo opaco (US26D)

Matt chrome (US26D)

3

Oro lucido (US3)

Polish gold (US3)

CG

Grigio chiaro (**polimero antibatterico**)

Light grey (**antibacterial polymer**)

1

Pomolo inferiore in metallo

Knob body in metal

FINITURE TASTO

UPPER CAPS FINISHES

ST

Senza tasto

Without upper caps

BO

Kelon bianco

Kelon white

CG

Kelon grigio chiaro

Kelon light grey

DG

Kelon grigio scuro

Kelon dark grey

NE

Kelon nero

Kelon black

RA

Rivestito acero

Maple texture

RW

Rivestito wengè

Wengè texture

AV

Verniciato aragosta

Red lobster coating

AZ

Verniciato azzurro

Light blue coating

LB

Verniciato blu gomma

Rubber finish, blue coating

VA

Verniciato verde acido

Acid green coating

26

Cromo lucido (US26)

Polish chrome (US26)

3

Oro lucido (US3)

Polish gold (US3)

ABO

Bianco (**polimero antibatterico**)

White (**antibacterial polymer**)

SCROCCO

TUBULAR LATCH

S

Senza Scrocco

Without tubular latch

T7

TB-60 entrata mm 60 (standard)

TB-60 backset 2 23/64" (standard)

T8

TB-70 entrata mm 70

TB-70 backset 2 3/4"

T9

TB-80 entrata mm 80

TB-80 backset 3 5/32"

A6

TB-127 entrata mm 127

TB-127 backset 5 1/64"

A7

TBA-60 antiscasso, entrata mm 60

TBA-60 security device, backset 2 23/64"

A8

TBA-70 antiscasso, entrata mm 70

TBA-70 security device, backset 2 3/4"

06

TBA-80 antiscasso, entrata mm 80

TBA-80 security device, backset 3 5/32"

07

TB-060 bordo in acciaio entrata mm 60

TB-060 steel edge, backset 2 23/64"

08

TB-070 bordo in acciaio entrata mm 70

TB-070 steel edge, backset 2 3/4"

6M

TB-080 bordo in acciaio entrata mm 80

TB-080 steel edge, backset 3 5/32"

7M

TBM-60 bordo mm 25 tondo magnetico

TBM-60 edge backset 2 23/64" magnetic

TBM-70 bordo mm 25 tondo magnetico

TBM-70 edge backset 2 3/4" magnetic

K12 PER BAGNI FOR BATHROOMS

SERIE
K

COMBINA

T	BORDO SCROCCO Quadro Tondo	LATCH FOREND Squared Round
	Larghezza mm 22	With 55/64"
+	SPESSORI PORTE mm 32 ÷ 60 mm 60 ÷ 70 > mm 70	DOOR THICKNESS 1 17/64" ÷ 2 23/64" 2 23/64" ÷ 2 3/4" > 2 3/4"
C	CONTROBORDI Senza controbordo	STRIKING PLATE Without striking plate
T	P875 quadro (standard)	P875 square (standard)
1	P875/T arrotondato	P875/T round-edge
1T	P896 refilato	P896 without forend
91	P896/T refilato arrotondato	P896/T without forend, round-edge
	P1291/R nylon nero, regolabile	P1291/R adjustable, black nylon

SERIE
K

K13 PER INGRESSO E UFFICI FOR ENTRANCES AND OFFICES

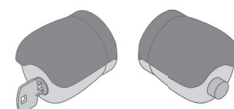

esterno
 outside

interno
 inside

FUNZIONE

Bloccabile o sbloccabile dall'esterno con chiave.
 Pomolo interno con bottone.
Con dispositivo di emergenza per lo sbloccaggio automatico.

FUNCTION

Locked or unlocked from outside by key.
 Inside knob with button.
With emergency device for automatic release.

K13	13/COMBINA senza scrocco senza controbordo	13/COMBINA without latch, without striking plate
FINITURE CORPO		BODY FINISHES
BO	Verniciato bianco	White coating
NA	Verniciato argento	Silver coating
NE	Verniciato nero	Black coating
15	Nickel opaco (US15)	Matt nickel (US15)
26	Cromo lucido (US26)	Polish chrome (US26)
6D	Cromo opaco (US26D)	Matt chrome (US26D)
3	Oro lucido (US3)	Polish gold (US3)
CG	Grigio chiaro (polimero antibatterico)	Light grey (antibacterial polymer)
1	Pomolo inferiore in metallo	Knob body in metal
FINITURE TASTO		UPPER CAPS FINISHES
ST	Senza tasto	Without upper caps
BO	Kelon bianco	Kelon white
CG	Kelon grigio chiaro	Kelon light grey
DG	Kelon grigio scuro	Kelon dark grey
NE	Kelon nero	Kelon black
RA	Rivestito acero	Maple texture
RW	Rivestito wengè	Wengè texture
AV	Verniciato aragosta	Red lobster coating
AZ	Verniciato azzurro	Light blue coating
LB	Verniciato blu gomma	Rubber finish, blue coating
VA	Verniciato verde acido	Acid green coating
26	Cromo lucido (US26)	Polish chrome (US26)
3	Oro lucido (US3)	Polish gold (US3)
ABO	Bianco (polimero antibatterico)	White (antibacterial polymer)
SCROCCO		TUBULAR LATCH
S	Senza Scrocco	Without tubular latch
	TB-60 entrata mm 60 (standard)	TB-60 backset 2 23/64" (standard)
T7	TB-70 entrata mm 70	TB-70 backset 2 3/4"
T8	TB-80 entrata mm 80	TB-80 backset 3 5/32"
T9	TB-127 entrata mm 127	TB-127 backset 5 1/64"
A6	TBA-60 antiscasso, entrata mm 60	TBA-60 security device, backset 2 23/64"
A7	TBA-70 antiscasso, entrata mm 70	TBA-70 security device, backset 2 3/4"
A8	TBA-80 antiscasso, entrata mm 80	TBA-80 security device, backset 3 5/32"
06	TB-060 bordo in acciaio entrata mm 60	TB-060 steel edge, backset 2 23/64"
07	TB-070 bordo in acciaio entrata mm 70	TB-070 steel edge, backset 2 3/4"
08	TB-080 bordo in acciaio entrata mm 80	TB-080 steel edge, backset 3 5/32"
6M	TBM-60 bordo mm 25 tondo magnetico	TBM-60 edge backset 2 23/64" magnetic
7M	TBM-70 bordo mm 25 tondo magnetico	TBM-70 edge backset 2 3/4" magnetic

K13 PER INGRESSO E UFFICI FOR ENTRANCES AND OFFICES

SERIE
K

COMBINA

	BORDO SCROCCO		LATCH FOREND
	Quadro		Squared
T	Tondo		Round
	CIFRATURE		KEY-CHANGES
	KD chiavi differenti		KD keyed differently
A	KA chiavi uguali		KD keyed alike
M	MK chiave maestra		MK master key
G	GMK chiave maestra generale		GMK general master key
K	GGMK chiave gran maestra generale		GGMK grand general master key
	SPESSORI PORTE		DOOR THICKNESS
	mm 32 ÷ 60		1 17/64" ÷ 2 23/64"
+	mm 60 ÷ 70		2 23/64" ÷ 2 3/4"
>	> mm 70		> 2 3/4"
	CONTROBORDI		STRIKING PLATE
	Senza controbordo		Without striking plate
	P875 quadro (standard)		P875 square (standard)
T	P875/T arrotondato		P875/T round-edge
1	P896 rifilato		P896 without forend
1T	P896/T rifilato arrotondato		P896/T without forend, round-edge
91	P1291/R nylon nero, regolabile		P1291/R adjustable, black nylon

SERIE
K

K15 PER INGRESSO E UFFICI FOR ENTRANCES AND OFFICES

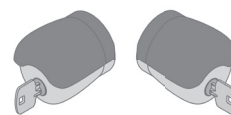

esterno
outside

interno
inside

FUNZIONE

Bloccabile o sbloccabile da entrambi i lati con chiave.

FUNCTION

Locked or unlocked from both sides by key.

K15	15/COMBINA senza scrocco senza controbordo	15/COMBINA without latch, without striking plate
FINITURE CORPO		BODY FINISHES
BO	Verniciato bianco	White coating
NA	Verniciato argento	Silver coating
NE	Verniciato nero	Black coating
15	Nickel opaco (US15)	Matt nickel (US15)
26	Cromo lucido (US26)	Polish chrome (US26)
6D	Cromo opaco (US26D)	Matt chrome (US26D)
3	Oro lucido (US3)	Polish gold (US3)
CG	Grigio chiaro (polimero antibatterico)	Light grey (antibacterial polymer)
1	Pomolo inferiore in metallo	Knob body in metal
FINITURE TASTO		UPPER CAPS FINISHES
ST	Senza tasto	Without upper caps
BO	Kelon bianco	Kelon white
CG	Kelon grigio chiaro	Kelon light grey
DG	Kelon grigio scuro	Kelon dark grey
NE	Kelon nero	Kelon black
RA	Rivestito acero	Maple texture
RW	Rivestito wengè	Wengè texture
AV	Verniciato aragosta	Red lobster coating
AZ	Verniciato azzurro	Light blue coating
LB	Verniciato blu gomma	Rubber finish, blue coating
VA	Verniciato verde acido	Acid green coating
26	Cromo lucido (US26)	Polish chrome (US26)
3	Oro lucido (US3)	Polish gold (US3)
ABO	Bianco (polimero antibatterico)	White (antibacterial polymer)
SCROCCO		TUBULAR LATCH
S	Senza Scrocco	Without tubular latch
	TB-60 entrata mm 60 (standard)	TB-60 backset 2 23/64" (standard)
T7	TB-70 entrata mm 70	TB-70 backset 2 3/4"
T8	TB-80 entrata mm 80	TB-80 backset 3 5/32"
T9	TB-127 entrata mm 127	TB-127 backset 5 1/64"
A6	TBA-60 antiscasso, entrata mm 60	TBA-60 security device, backset 2 23/64"
A7	TBA-70 antiscasso, entrata mm 70	TBA-70 security device, backset 2 3/4"
A8	TBA-80 antiscasso, entrata mm 80	TBA-80 security device, backset 3 5/32"
O6	TB-060 bordo in acciaio entrata mm 60	TB-060 steel edge, backset 2 23/64"
O7	TB-070 bordo in acciaio entrata mm 70	TB-070 steel edge, backset 2 3/4"
O8	TB-080 bordo in acciaio entrata mm 80	TB-080 steel edge, backset 3 5/32"
6M	TBM-60 bordo mm 25 tondo magnetico	TBM-60 edge backset 2 23/64" magnetic
7M	TBM-70 bordo mm 25 tondo magnetico	TBM-70 edge backset 2 3/4" magnetic

K15 PER INGRESSO E UFFICI FOR ENTRANCES AND OFFICES

SERIE
K

COMBINA

	BORDO SCROCCO		LATCH FOREND
	Quadro		Squared
T	Tondo		Round
	CIFRATURE		KEY-CHANGES
	KD chiavi differenti		KD keyed differently
A	KA chiavi uguali		KD keyed alike
M	MK chiave maestra		MK master key
G	GMK chiave maestra generale		GMK general master key
K	GGMK chiave gran maestra generale		GGMK grand general master key
	SPESSORI PORTE		DOOR THICKNESS
	mm 32 ÷ 60		1 17/64" ÷ 2 23/64"
+	mm 60 ÷ 70		2 23/64" ÷ 2 3/4"
>	> mm 70		> 2 3/4"
	CONTROBORDI		STRIKING PLATE
C	Senza controbordo		Without striking plate
	P875 quadro (standard)		P875 square (standard)
T	P875/T arrotondato		P875/T round-edge
1	P896 refilato		P896 without forend
1T	P896/T refilato arrotondato		P896/T without forend, round-edge
91	P1291/R nylon nero, regolabile		P1291/R adjustable, black nylon

SERIE
K

K17 PER AULE SCOLASTICHE E UFFICI FOR CLASSROOMS AND OFFICES

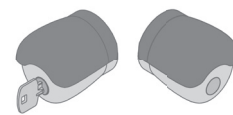

esterno
outside

interno
inside

FUNZIONE

Bloccabile o sbloccabile dall'esterno con chiave.
 Tasto interno sempre azionabile.

FUNCTION

Locked or unlocked from outside by key.
 Inside upper caps for free passage.

K17	17/COMBINA senza scrocco senza controbordo	17/COMBINA without latch, without striking plate
FINITURE CORPO		BODY FINISHES
BO	Verniciato bianco	White coating
NA	Verniciato argento	Silver coating
NE	Verniciato nero	Black coating
15	Nickel opaco (US15)	Matt nickel (US15)
26	Cromo lucido (US26)	Polish chrome (US26)
6D	Cromo opaco (US26D)	Matt chrome (US26D)
3	Oro lucido (US3)	Polish gold (US3)
CG	Grigio chiaro (polimero antibatterico)	Light grey (antibacterial polymer)
1	Pomolo inferiore in metallo	Knob body in metal
FINITURE TASTO		UPPER CAPS FINISHES
ST	Senza tasto	Without upper caps
BO	Kelon bianco	Kelon white
CG	Kelon grigio chiaro	Kelon light grey
DG	Kelon grigio scuro	Kelon dark grey
NE	Kelon nero	Kelon black
RA	Rivestito acero	Maple texture
RW	Rivestito wengè	Wengè texture
AV	Verniciato aragosta	Red lobster coating
AZ	Verniciato azzurro	Light blue coating
LB	Verniciato blu gomma	Rubber finish, blue coating
VA	Verniciato verde acido	Acid green coating
26	Cromo lucido (US26)	Polish chrome (US26)
3	Oro lucido (US3)	Polish gold (US3)
ABO	Bianco (polimero antibatterico)	White (antibacterial polymer)
SCROCCO		TUBULAR LATCH
S	Senza Scrocco	Without tubular latch
	TB-60 entrata mm 60 (standard)	TB-60 backset 2 23/64" (standard)
T7	TB-70 entrata mm 70	TB-70 backset 2 3/4"
T8	TB-80 entrata mm 80	TB-80 backset 3 5/32"
T9	TB-127 entrata mm 127	TB-127 backset 5 1/64"
A6	TBA-60 antiscasso, entrata mm 60	TBA-60 security device, backset 2 23/64"
A7	TBA-70 antiscasso, entrata mm 70	TBA-70 security device, backset 2 3/4"
A8	TBA-80 antiscasso, entrata mm 80	TBA-80 security device, backset 3 5/32"
O6	TB-060 bordo in acciaio entrata mm 60	TB-060 steel edge, backset 2 23/64"
O7	TB-070 bordo in acciaio entrata mm 70	TB-070 steel edge, backset 2 3/4"
O8	TB-080 bordo in acciaio entrata mm 80	TB-080 steel edge, backset 3 5/32"
6M	TBM-60 bordo mm 25 tondo magnetico	TBM-60 edge backset 2 23/64" magnetic
7M	TBM-70 bordo mm 25 tondo magnetico	TBM-70 edge backset 2 3/4" magnetic

K17 PER AULE SCOLASTICHE E UFFICI FOR CLASSROOMS AND OFFICES

SERIE
K

COMBINA

	BORDO SCROCCO		LATCH FOREND
	Quadro		Squared
T	Tondo		Round
	CIFRATURE		KEY-CHANGES
	KD chiavi differenti		KD keyed differently
A	KA chiavi uguali		KD keyed alike
M	MK chiave maestra		MK master key
G	GMK chiave maestra generale		GMK general master key
K	GGMK chiave gran maestra generale		GGMK grand general master key
	SPESSORI PORTE		DOOR THICKNESS
	mm 32 ÷ 60		1 17/64" ÷ 2 23/64"
+	mm 60 ÷ 70		2 23/64" ÷ 2 3/4"
>	> mm 70		> 2 3/4"
	CONTROBORDI		STRIKING PLATE
C	Senza controbordo		Without striking plate
	P875 quadro (standard)		P875 square (standard)
T	P875/T arrotondato		P875/T round-edge
1	P896 refilato		P896 without forend
1T	P896/T refilato arrotondato		P896/T without forend, round-edge
91	P1291/R nylon nero, regolabile		P1291/R adjustable, black nylon

SERIE
K

K20 PER APPLICAZIONI VARIE FOR DIFFERENT APPLICATIONS

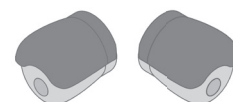

FUNZIONE

Doppia impugnatura fissa senza pulsante

FUNCTION

Double fixed knob

K20	20/COMBINA	20/COMBINA
	FINITURE CORPO	BODY FINISHES
BO	Verniciato bianco	White coating
NA	Verniciato argento	Silver coating
NE	Verniciato nero	Black coating
15	Nickel opaco (US15)	Matt nickel (US15)
26	Cromo lucido (US26)	Polish chrome (US26)
6D	Cromo opaco (US26D)	Matt chrome (US26D)
3	Oro lucido (US3)	Polish gold (US3)
CG	Grigio chiaro (polimero antibatterico)	Light grey (antibacterial polymer)
1	Pomolo inferiore in metallo	Knob body in metal
	FINITURE TASTO	UPPER CAPS FINISHES
ST	Senza tasto	Without upper caps
BO	Kelon bianco	Kelon white
CG	Kelon grigio chiaro	Kelon light grey
DG	Kelon grigio scuro	Kelon dark grey
NE	Kelon nero	Kelon black
RA	Rivestito acero	Maple texture
RW	Rivestito wengè	Wengè texture
AV	Verniciato aragosta	Red lobster coating
AZ	Verniciato azzurro	Light blue coating
LB	Verniciato blu gomma	Rubber finish, blue coating
VA	Verniciato verde acido	Acid green coating
26	Cromo lucido (US26)	Polish chrome (US26)
3	Oro lucido (US3)	Polish gold (US3)
ABO	Bianco (polimero antibatterico)	White (antibacterial polymer)



K21 PER APPLICAZIONI VARIE FOR DIFFERENT APPLICATIONS

SERIE
K

FUNZIONE

Impugnatura esterna fissa senza pulsante

FUNCTION

Outside fixed knob

K21

21/COMBINA

21/COMBINA

FINITURE CORPO

BODY FINISHES

BO

Verniciato bianco

White coating

NA

Verniciato argento

Silver coating

NE

Verniciato nero

Black coating

15

Nichel opaco (US15)

Matt nickel (US15)

26

Cromo lucido (US26)

Polish chrome (US26)

6D

Cromo opaco (US26D)

Matt chrome (US26D)

3

Oro lucido (US3)

Polish gold (US3)

CG

Grigio chiaro (**polimero antibatterico**)

Light grey (**antibacterial polymer**)

1

Pomolo inferiore in metallo

Knob body in metal

FINITURE TASTO

UPPER CAPS FINISHES

ST

Senza tasto

Without upper caps

BO

Kelon bianco

Kelon white

CG

Kelon grigio chiaro

Kelon light grey

DG

Kelon grigio scuro

Kelon dark grey

NE

Kelon nero

Kelon black

RA

Rivestito acero

Maple texture

RW

Rivestito wengè

Wengè texture

AV

Verniciato aragosta

Red lobster coating

AZ

Verniciato azzurro

Light blue coating

LB

Verniciato blu gomma

Rubber finish, blue coating

VA

Verniciato verde acido

Acid green coating

26

Cromo lucido (US26)

Polish chrome (US26)

3

Oro lucido (US3)

Polish gold (US3)

ABO

Bianco (**polimero antibatterico**)

White (**antibacterial polymer**)

SERIE
K

K24 PER CAMERE D'ALBERGO FOR HOTEL ROOMS

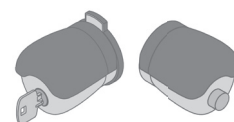

esterno
 outside

interno
 inside

FUNZIONE

Pomolo esterno con tasto fisso, apertura solo con chiave.

Pomolo interno con bottone che aziona il segnalatore di occupato.

Con dispositivo di emergenza per lo sbloccaggio automatico.

FUNCTION

Outside knob with upper cap fixed, unlocked only by key.

Inside knob with button acting on occupancy indicator.

With emergency device for automatic release.

K24

24/COMBINA senza scrocco senza controbordo

24/COMBINA without latch, without striking plate

FINITURE CORPO

BO
NA
NE
15
26
6D
3
CG

Verniciato bianco
 Verniciato argento
 Verniciato nero
 Nickel opaco (US15)
 Cromo lucido (US26)
 Cromo opaco (US26D)
 Oro lucido (US3)
 Grigio chiaro (**polimero antibatterico**)

BODY FINISHES

White coating
 Silver coating
 Black coating
 Matt nickel (US15)
 Polish chrome (US26)
 Matt chrome (US26D)
 Polish gold (US3)
 Light grey (**antibacterial polymer**)

1

Pomolo inferiore in metallo

Knob body in metal

FINITURE TASTO

ST
BO
CG
DG
NE
RA
RW
AV
AZ
LB
VA
26
3
ABO

Senza tasto
 Kelon bianco
 Kelon grigio chiaro
 Kelon grigio scuro
 Kelon nero
 Rivestito acero
 Rivestito wengè
 Verniciato aragosta
 Verniciato azzurro
 Verniciato blu gomma
 Verniciato verde acido
 Cromo lucido (US26)
 Oro lucido (US3)
 Bianco (**polimero antibatterico**)

UPPER CAPS FINISHES

Without upper caps
 Kelon white
 Kelon light grey
 Kelon dark grey
 Kelon black
 Maple texture
 Wengè texture
 Red lobster coating
 Light blue coating
 Rubber finish, blue coating
 Acid green coating
 Polish chrome (US26)
 Polish gold (US3)
 White (**antibacterial polymer**)

SCROCCO

S
T7
T8
T9
A6
A7
A8
O6
O7
O8
6M
7M

Senza Scrocco
 TB-60 entrata mm 60 (standard)
 TB-70 entrata mm 70
 TB-80 entrata mm 80
 TB-127 entrata mm 127
 TBA-60 antiscasso, entrata mm 60
 TBA-70 antiscasso, entrata mm 70
 TBA-80 antiscasso, entrata mm 80
 TB-060 bordo in acciaio entrata mm 60
 TB-070 bordo in acciaio entrata mm 70
 TB-080 bordo in acciaio entrata mm 80
 TBM-60 bordo mm 25 tondo magnetico
 TBM-70 bordo mm 25 tondo magnetico

TUBULAR LATCH

Without tubular latch
 TB-60 backset 2 23/64" (standard)
 TB-70 backset 2 3/4"
 TB-80 backset 3 5/32"
 TB-127 backset 5 1/64"
 TBA-60 security device, backset 2 23/64"
 TBA-70 security device, backset 2 3/4"
 TBA-80 security device, backset 3 5/32"
 TB-060 steel edge, backset 2 23/64"
 TB-070 steel edge, backset 2 3/4"
 TB-080 steel edge, backset 3 5/32"
 TBM-60 edge backset 2 23/64" magnetic
 TBM-70 edge backset 2 3/4" magnetic

K24 PER CAMERE D'ALBERGO FOR HOTEL ROOMS

SERIE
K

COMBINA

	BORDO SCROCCO		LATCH FOREND
	Quadro		Squared
T	Tondo		Round
	CIFRATURE		KEY-CHANGES
	KD chiavi differenti		KD keyed differently
A	KA chiavi uguali		KD keyed alike
M	MK chiave maestra		MK master key
G	GMK chiave maestra generale		GMK general master key
K	GGMK chiave gran maestra generale		GGMK grand general master key
	SPESSORI PORTE		DOOR THICKNESS
	mm 32 ÷ 60		1 17/64" ÷ 2 23/64"
+	mm 60 ÷ 70		2 23/64" ÷ 2 3/4"
>	> mm 70		> 2 3/4"
	CONTROBORDI		STRIKING PLATE
	Senza controbordo		Without striking plate
	P875 quadro (standard)		P875 square (standard)
T	P875/T arrotondato		P875/T round-edge
1	P896 refilato		P896 without forend
1T	P896/T refilato arrotondato		P896/T without forend, round-edge
91	P1291/R nylon nero, regolabile		P1291/R adjustable, black nylon

SERIE
K

ACCESSORI COMBINA PER VETRO COMBINA GLASS ACCESSORIES

FGLA 70

FGLA



NA
NE
BO
GR
3
15
26
6D

**Scrocco con antiscasso
per porte vetro**

FINITURE

Verniciato argento
Verniciato nero
Verniciato bianco
Grigio
Oro lucido (US3)
Nickel opaco (US15)
Cromo lucido (US26)
Cromo opaco (US26D)

**Latch with security device
for glass doors**

FINISHES

Silver coating
Black coating
White coating
Grey
Polish gold (US3)
Matt nickel (US15)
Polish chrome (US26)
Matt chrome (US26D)

FGL 1

FGL1



NA
NE
BO
GR
3
15
26
6D

**Piastra controbordo
per porte vetro**

FINITURE

Verniciato argento
Verniciato nero
Verniciato bianco
Grigio
Oro lucido (US3)
Nickel opaco (US15)
Cromo lucido (US26)
Cromo opaco (US26D)

**Striking plate
for double glass doors**

FINISHES

Silver coating
Black coating
White coating
Grey
Polish gold (US3)
Matt nickel (US15)
Polish chrome (US26)
Matt chrome (US26D)

FGLR

FGLR



NA
NE

**Scrocco per porta vetro
con profilo in alluminio**

FINITURE

Verniciato argento
Verniciato nero

**Latch for glass doors
with aluminium profile**

FINISHES

Silver coating
Black coating

FGLAD

FGLAD



84
NE
GR

**Adattatore porte vetro
con profilo in alluminio**

DIMENSIONI

mm 41
mm 84

FINITURE

Verniciato nero
Grigio

**Glass door adapter
with aluminium profile**

SIZE

mm 41
Grey

FINISHES

Black coating
Grey

ACCESSORI COMBINA COMBINA ACCESSORIES

SERIE
K

COMBINA

KGTA

Coppia tasti

Couple of upper caps

BO
CG
DG
NE
RA
RW
AV
AZ
LB
VA
26
3

FINITURE STANDARD

Kelon bianco
 Kelon grigio chiaro
 Kelon grigio scuro
 Kelon nero
 Rivestito acero
 Rivestito wengè
 Verniciato aragosta
 Verniciato azzurro
 Verniciato blu gomma
 Verniciato verde acido
 Cromo lucido (US26)
 Oro lucido (US3)

STANDARD FINISHES

Kelon white
 Kelon light grey
 Kelon dark grey
 Kelon black
 Maple texture
 Wengè texture
 Red lobster coating
 Light blue coating
 Rubber finish, blue coating
 Acid green coating
 Polish chrome (US26)
 Polish gold (US3)

AM
BV
GP
VV
GG
LR
OR
VP
RR
RC

FINITURE A RICHIESTA (*)

Amaranto metallizzato
 Blu pastello
 Giallo pastello
 Verde pastello
 Verde scuro gommato
 Rosso gommato
 Arancione gommato
 Verde perla
 Rivestito radica
 Rivestito carbonio

FINISHES ON REQUEST (*)

Metalized amaranth
 Blue
 Yellow
 Green
 Rubber finish, dark green
 Rubber finish, red
 Rubber finish, orange
 Pearl green
 Brier texture
 Carbon fibre

C

Confezione 5 coppie
 con 1 chiave di rimozione

Packaging: 5 pair
 and removal key

(*) Quantità minima per ordine
 50 coppie

(*) Minimum order quantity
 50 pair

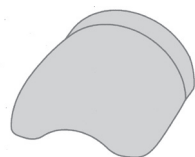

KUTST

Chiave rimozione tasto

Upper caps removal key

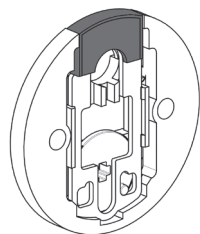

KSG

Segnalatore di occupato

Polimero grigio

Occupancy indicator

Polymer grey

12

Art. 12 Ø 54,40 mm

Art. 12 Ø 54,40 mm

24

Art. 24 Ø 54,40 mm

Art. 24 Ø 54,40 mm

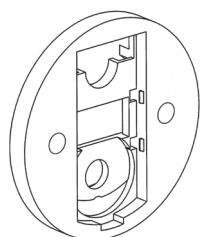

KROSE

Rosetta in nylon

Polimero grigio

Nylon rose

Polymer grey

Ø 54,40 mm

Ø 54,40 mm

Ø 54,40 mm

info e preventivi
<http://www.bellittiserrature.it/contact.asp>



FORMA

info e preventivi
<http://www.bellittiserrature.it/contact.asp>

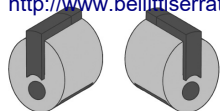

esterno
outside

interno
inside

F11 PER LOCALI DI PASSAGGIO FOR PASSAGEWAYS

SERIE
F

FUNZIONE

Entrambi i pulsanti sempre azionabili.

FUNCTION

Outside and inside push-buttons for free passage.

F11 11/FORMA senza scrocco senza controbordo

11/FORMA without latch, without striking plate

FINITURE

3	Oro lucido (US3)
4K	Oro opaco (24K)
26	Cromo lucido (US26)
6D	Cromo opaco (US26D)
15	Nickel opaco (US15)
NA	Verniciato argento
BO	Polimero bianco
GR	Polimero grigio
NE	Polimero nero

FINISHES

Polish gold (US3)
Matt gold (24K)
Polish chrome (US26)
Matt chrome (US26D)
Matt nickel (US15)
Silver coating
Polymer white
Polymer grey
Polymer black

SCROCCO

S	Senza scrocco
	TB-60 entrata mm 60 (standard)
T7	TB-70 entrata mm 70
T8	TB-80 entrata mm 80
T9	TB-127 entrata mm 127
A6	TBA-60 antiscasso, entrata mm 60
A7	TBA-70 antiscasso, entrata mm 70
A8	TBA-80 antiscasso, entrata mm 80
06	TB-060 bordo in acciaio, entrata mm 60
07	TB-070 bordo in acciaio, entrata mm 70
08	TB-080 bordo in acciaio, entrata mm 80
6M	TBM-60 bordo mm 25 tondo magnetico
7M	TBM-70 bordo mm 25 tondo magnetico

TUBULAR LATCH

Without tubular latch
TB-60 backset 2 23/64" (standard)
TB-70 backset 2 3/4"
TB-80 backset 3 5/32"
TB-127 backset 5 1/64"
TBA-60 security device, backset 2 23/64"
TBA-70 security device, backset 2 3/4"
TBA-80 security device, backset 3 5/32"
TB-060 steel edge, backset 2 23/64"
TB-070 steel edge, backset 2 3/4"
TB-080 steel edge, backset 3 5/32"
TBM-60 edge backset 2 23/64" magnetic extra € 15,00
TBM-70 edge backset 2 3/4" magnetic extra € 15,50

BORDO SCROCCO

	Quadro
T	Tondo

LATCH FOREND

Squared
Round

Larghezza mm 22

Width 55/64"

SPESSORI PORTE

	mm 32 ÷ 60
+	mm 60 ÷ 70
>	> mm 70

DOOR THICKNESS

1 17/64" ÷ 2 23/64"
2 23/64" ÷ 2 3/4"
> 2 3/4"

CONTROBORDI

C	Senza controbordo
	P875 quadro
T	P875/T arrotondato
1	P896 refilato
1T	P896/T refilato arrotondato
91	P1291/R nylon nero regolabile

STRIKING PLATE

Without striking plate
P875 square
P875/T round-edge
P896 without forend
P896/T without forend, round-edge
P1291/R adjustable, black nylon

SERIE
F

F12 PER BAGNO FOR BATHROOMS

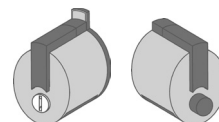

esterno
 outside

interno
 inside

FUNZIONE

Apertura esterna con chiave d'emergenza, moneta, cacciavite, o qualsiasi attrezzo simile. Pomolo interno con bottone che aziona il segnalatore di occupato se utilizzato.

Con dispositivo di emergenza per lo sbloccaggio automatico.

FUNCTION

Unlocked from outside by emergency key, coin, screwdriver or any other similar tool. Inside knob with button acting on occupancy indicator if provided.

With emergency device for automatic release.

F12 12/FORMA senza scrocco senza controbordo

12/FORMA without latch, without striking plate

FINITURE

3	Oro lucido (US3)
4K	Oro opaco (24K)
26	Cromo lucido (US26)
6D	Cromo opaco (US26D)
15	Nickel opaco (US15)
NA	Verniciato argento
BO	Polimero bianco
GR	Polimero grigio
NE	Polimero nero

FINISHES

Polish gold (US3)
Matt gold (24K)
Polish chrome (US26)
Matt chrome (US26D)
Matt nickel (US15)
Silver coating
Polymer white
Polymer grey
Polymer black

SCROCCO

S	Senza scrocco
T7	TB-60 entrata mm 60 (standard)
T8	TB-70 entrata mm 70
T9	TB-80 entrata mm 80
A6	TB-127 entrata mm 127
A7	TBA-60 antiscasso, entrata mm 60
A8	TBA-70 antiscasso, entrata mm 70
06	TBA-80 antiscasso, entrata mm 80
07	TB-060 bordo in acciaio, entrata mm 60
08	TB-070 bordo in acciaio, entrata mm 70
6M	TB-080 bordo in acciaio, entrata mm 80
7M	TBM-60 bordo mm 25 tondo magnetico
	TBM-70 bordo mm 25 tondo magnetico

TUBULAR LATCH

Without tubular latch
TB-60 backset 2 23/64" (standard)
TB-70 backset 2 3/4"
TB-80 backset 3 5/32"
TB-127 backset 5 1/64"
TBA-60 security device, backset 2 23/64"
TBA-70 security device, backset 2 3/4"
TBA-80 security device, backset 3 5/32"
TB-060 steel edge, backset 2 23/64"
TB-070 steel edge, backset 2 3/4"
TB-080 steel edge, backset 3 5/32"
TBM-60 edge backset 2 23/64" magnetic
TBM-70 edge backset 2 3/4" magnetic

BORDO SCROCCO

T	Quadro	Squared
	Tondo	Round

LATCH FOREND

Larghezza mm 22

Width 55/64"

SPESSORI PORTE

+	mm 32 ÷ 60	1 17/64" ÷ 2 23/64"
>	mm 60 ÷ 70	2 23/64" ÷ 2 3/4"
	> mm 70	> 2 3/4"

DOOR THICKNESS

CONTROBORDI

C	Senza controbordo	Without striking plate
T	P875 quadro	P875 square
1	P875/T arrotondato	P875/T round-edge
1T	P896 rifilato	P896 without forend
91	P896/T rifilato arrotondato	P896/T without forend, round-edge
	P1291/R nylon nero regolabile	P1291/R adjustable, black nylon

STRIKING PLATE

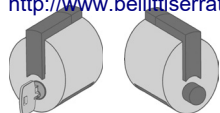

esterno
outside

interno
inside

F13 PER INGRESSO E UFFICI FOR ENTRANCES AND OFFICES

SERIE
F

FUNZIONE

Bloccabile o sbloccabile dall'esterno con chiave.
 Pomolo interno con bottone.

Con dispositivo di emergenza per lo sbloccaggio automatico.

FUNCTION

Locked or unlocked from outside by the key.
 Outside knob with button.

With emergency device for automatic release.

F13 13/FORMA senza scrocco senza controbordo

13/FORMA without latch, without striking plate

FINITURE

3	Oro lucido (US3)
4K	Oro opaco (24K)
26	Cromo lucido (US26)
6D	Cromo opaco (US26D)
15	Nickel opaco (US15)
NA	Verniciato argento
BO	Polimero bianco
GR	Polimero grigio
NE	Polimero nero

FINISHES

Polish gold (US3)
Matt gold (24K)
Polish chrome (US26)
Matt chrome (US26D)
Matt nickel (US15)
Silver coating
Polymer white
Polymer grey
Polymer black

SCROCCO

S	Senza scrocco
T7	TB-60 entrata mm 60 (standard)
T8	TB-70 entrata mm 70
T9	TB-80 entrata mm 80
A6	TB-127 entrata mm 127
A7	TBA-60 antiscasso, entrata mm 60
A8	TBA-70 antiscasso, entrata mm 70
06	TBA-80 antiscasso, entrata mm 80
07	TB-060 bordo in acciaio, entrata mm 60
08	TB-070 bordo in acciaio, entrata mm 70
6M	TB-080 bordo in acciaio, entrata mm 80
7M	TBM-60 bordo mm 25 tondo magnetico
	TBM-70 bordo mm 25 tondo magnetico

TUBULAR LATCH

Without tubular latch
TB-60 backset 2 23/64" (standard)
TB-70 backset 2 3/4"
TB-80 backset 3 5/32"
TB-127 backset 5 1/64"
TBA-60 security device, backset 2 23/64"
TBA-70 security device, backset 2 3/4"
TBA-80 security device, backset 3 5/32"
TB-060 steel edge, backset 2 23/64"
TB-070 steel edge, backset 2 3/4"
TB-080 steel edge, backset 3 5/32"
TBM-60 edge backset 2 23/64" magnetic
TBM-70 edge backset 2 3/4" magnetic

BORDO SCROCCO

T	Quadro
	Tondo

LATCH FOREND

Squared
Round

Larghezza mm 22

Width 55/64"

CIFRATURE

A	KD chiavi differenti
M	KA chiavi uguali
G	MK chiave maestra
K	GMK chiave maestra generale
	GGMK chiave gran maestra generale

KEY-CHANGES

KD keyed differently
KA keyed alike
MK master key
GMK general master key
GGMK grand general master key

SPessori PORTE

	mm 32 ÷ 60
+	mm 60 ÷ 70
>	> mm 70

DOOR THICKNESS

1 17/64" ÷ 2 23/64"
2 23/64" ÷ 2 3/4"
> 2 3/4"

CONTROBORDI

C	Senza controbordo
T	P875 quadro
1	P875/T arrotondato
1T	P896 refilato
91	P896/T refilato arrotondato
	P1291/R nylon nero regolabile

STRIKING PLATE

Without striking plate
P875 square
P875/T round-edge
P896 without forend
P896/T without forend, round-edge
P1291/R adjustable, black nylon

SERIE
F

F15 PER INGRESSO E UFFICI FOR ENTRANCES AND OFFICES

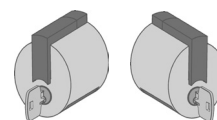

esterno
 outside

interno
 inside

FUNZIONE

Bloccabile o sbloccabile da entrambi i lati con chiave.

FUNCTION

Locked or unlocked from both sides by key.

F15	15/FORMA senza scrocco senza controbordo	15/FORMA without latch, without striking plate
FINITURE		FINISHES
3	Oro lucido (US3)	Polish gold (US3)
4K	Oro opaco (24K)	Matt gold (24K)
26	Cromo lucido (US26)	Polish chrome (US26)
6D	Cromo opaco (US26D)	Matt chrome (US26D)
15	Nickel opaco (US15)	Matt nickel (US15)
NA	Verniciato argento	Silver coating
BO	Polimero bianco	Polymer white
GR	Polimero grigio	Polymer grey
NE	Polimero nero	Polymer black
SCROCCO		TUBULAR LATCH
S	Senza scrocco	Without tubular latch
	TB-60 entrata mm 60 (standard)	TB-60 backset 2 23/64" (standard)
T7	TB-70 entrata mm 70	TB-70 backset 2 3/4"
T8	TB-80 entrata mm 80	TB-80 backset 3 5/32"
T9	TB-127 entrata mm 127	TB-127 backset 5 1/64"
A6	TBA-60 antiscasso, entrata mm 60	TBA-60 security device, backset 2 23/64"
A7	TBA-70 antiscasso, entrata mm 70	TBA-70 security device, backset 2 3/4"
A8	TBA-80 antiscasso, entrata mm 80	TBA-80 security device, backset 3 5/32"
06	TB-060 bordo in acciaio, entrata mm 60	TB-060 steel edge, backset 2 23/64"
07	TB-070 bordo in acciaio, entrata mm 70	TB-070 steel edge, backset 2 3/4"
08	TB-080 bordo in acciaio, entrata mm 80	TB-080 steel edge, backset 3 5/32"
6M	TBM-60 bordo mm 25 tondo magnetico	TBM-60 edge backset 2 23/64" magnetic
7M	TBM-70 bordo mm 25 tondo magnetico	TBM-70 edge backset 2 3/4" magnetic
BORDO SCROCCO		LATCH FOREND
	Quadro	Squared
T	Tondo	Round
	Larghezza mm 22	Width 55/64"
CIFRATURE		KEY-CHANGES
	KD chiavi differenti	KD keyed differently
A	KA chiavi uguali	KA keyed alike
M	MK chiave maestra	MK master key
G	GMK chiave maestra generale	GMK general master key
K	GGMK chiave gran maestra generale	GGMK grand general master key
SPessori PORTE		DOOR THICKNESS
	mm 32 ÷ 60	1 17/64" ÷ 2 23/64"
+	mm 60 ÷ 70	2 23/64" ÷ 2 3/4"
>	> mm 70	> 2 3/4"
CONTROBORDI		STRIKING PLATE
C	Senza controbordo	Without striking plate
	P875 quadro	P875 square
T	P875/T arrotondato	P875/T round-edge
1	P896 rifilato	P896 without forend
1T	P896/T rifilato arrotondato	P896/T without forend, round-edge
91	P1291/R nylon nero regolabile	P1291/R adjustable, black nylon

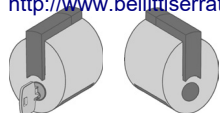

esterno
outside

interno
inside

F17 PER AULE SCOLASTICHE E UFFICI FOR CLASSROOMS AND OFFICES

SERIE
F

FUNZIONE

Bloccabile o sbloccabile dall'esterno con chiave.
 Pulsante interno sempre azionabile.

FUNCTION

Locked or unlocked from outside by key.
 Inside push-button for free passage.

F17 17/FORMA senza scrocco senza controbordo

17/FORMA without latch, without striking plate

FINITURE

3	Oro lucido (US3)
4K	Oro opaco (24K)
26	Cromo lucido (US26)
6D	Cromo opaco (US26D)
15	Nickel opaco (US15)
NA	Verniciato argento
BO	Polimero bianco
GR	Polimero grigio
NE	Polimero nero

FINISHES

Polish gold (US3)
Matt gold (24K)
Polish chrome (US26)
Matt chrome (US26D)
Matt nickel (US15)
Silver coating
Polymer white
Polymer grey
Polymer black

SCROCCO

S	Senza scrocco
	TB-60 entrata mm 60 (standard)
T7	TB-70 entrata mm 70
T8	TB-80 entrata mm 80
T9	TB-127 entrata mm 127
A6	TBA-60 antiscasso, entrata mm 60
A7	TBA-70 antiscasso, entrata mm 70
A8	TBA-80 antiscasso, entrata mm 80
06	TB-060 bordo in acciaio, entrata mm 60
07	TB-070 bordo in acciaio, entrata mm 70
08	TB-080 bordo in acciaio, entrata mm 80
6M	TBM-60 bordo mm 25 tondo magnetico
7M	TBM-70 bordo mm 25 tondo magnetico

TUBULAR LATCH

Without tubular latch
TB-60 backset 2 23/64" (standard)
TB-70 backset 2 3/4"
TB-80 backset 3 5/32"
TB-127 backset 5 1/64"
TBA-60 security device, backset 2 23/64"
TBA-70 security device, backset 2 3/4"
TBA-80 security device, backset 3 5/32"
TB-060 steel edge, backset 2 23/64"
TB-070 steel edge, backset 2 3/4"
TB-080 steel edge, backset 3 5/32"
TBM-60 edge backset 2 23/64" magnetic
TBM-70 edge backset 2 3/4" magnetic

BORDO SCROCCO

	Quadro
T	Tondo

LATCH FOREND

Squared
Round

Larghezza mm 22

Width 55/64"

CIFRATURE

	KD chiavi differenti
A	KA chiavi uguali
M	MK chiave maestra
G	GMK chiave maestra generale
K	GGMK chiave gran maestra generale

KEY-CHANGES

KD keyed differently
KA keyed alike
MK master key
GMK general master key
GGMK grand general master key

SPessori PORTE

	mm 32 ÷ 60
+	mm 60 ÷ 70
>	> mm 70

DOOR THICKNESS

1 17/64" ÷ 2 23/64"
2 23/64" ÷ 2 3/4"
> 2 3/4"

CONTROBORDI

C	Senza controbordo
	P875 quadro
T	P875/T arrotondato
1	P896 rifilato
1T	P896/T rifilato arrotondato
91	P1291/R nylon nero regolabile

STRIKING PLATE

Without striking plate
P875 square
P875/T round-edge
P896 without forend
P896/T without forend, round-edge
P1291/R adjustable, black nylon

SERIE
F

F20 APPLICAZIONI VARIE DIFFERENT APPLICATIONS

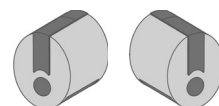

FUNZIONE

Doppia impugnatura fissa senza pulsante.

FUNCTION

Double fixed knob.

F20

20/FORMA

20/FORMA

FINITURE

FINISHES

3
4K
26
6D
15
NA
BO
GR
NE

Oro lucido (US3)
Oro opaco (24K)
Cromo lucido (US26)
Cromo opaco (US26D)
Nickel opaco (US15)
Verniciato argento
Polimero bianco
Polimero grigio
Polimero nero

Polish gold (US3)
Matt gold (24K)
Polish chrome (US26)
Matt chrome (US26D)
Matt nickel (US15)
Silver coating
Polymer white
Polymer grey
Polymer black



F21 APPLICAZIONI VARIE DIFFERENT APPLICATIONS

SERIE
F

FUNZIONE

Impugnatura esterna fissa senza pulsante.

FUNCTION

Outside fixed knob.

F21

21/FORMA

21/FORMA

FINITURE

FINISHES

3	Oro lucido (US3)	Polish gold (US3)
4K	Oro opaco (24K)	Matt gold (24K)
26	Cromo lucido (US26)	Polish chrome (US26)
6D	Cromo opaco (US26D)	Matt chrome (US26D)
15	Nickel opaco (US15)	Matt nickel (US15)
NA	Verniciato argento	Silver coating
BO	Polimero bianco	Polymer white
GR	Polimero grigio	Polymer grey
NE	Polimero nero	Polymer black

SERIE
F

F24 PER CAMERE D'ALBERGO FOR HOTELS ROOMS

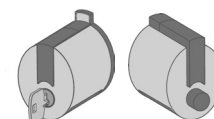

esterno
 outside

interno
 inside

FUNZIONE

Pomolo esterno senza pulsante, apertura solo con chiave.

Pomolo interno con bottone che aziona il segnalatore di occupato se utilizzato.

Con dispositivo di emergenza per lo sbloccaggio automatico.

FUNCTION

Outside knob without push-button, unlocked only by key.

Inside knob with button acting on occupancy indicator if provided.

With emergency device for automatic release.

F24

24/FORMA senza scrocco senza controbordo

24/FORMA without latch, without striking plate

FINITURE

FINISHES

3 Oro lucido (US3)

Polish gold (US3)

4K Oro opaco (24K)

Matt gold (24K)

26 Cromo lucido (US26)

Polish chrome (US26)

6D Cromo opaco (US26D)

Matt chrome (US26D)

15 Nickel opaco (US15)

Matt nickel (US15)

NA Verniciato argento

Silver coating

BO Polimero bianco

Polymer white

GR Polimero grigio

Polymer grey

NE Polimero nero

Polymer black

SCROCCO

TUBULAR LATCH

Senza scrocco

Without tubular latch

S TB-60 entrata mm 60 (standard)

TB-60 backset 2 23/64" (standard)

T7 TB-70 entrata mm 70

TB-70 backset 2 3/4"

T8 TB-80 entrata mm 80

TB-80 backset 3 5/32"

T9 TB-127 entrata mm 127

TB-127 backset 5 1/64"

A6 TBA-60 antiscasso, entrata mm 60

TBA-60 security device, backset 2 23/64"

A7 TBA-70 antiscasso, entrata mm 70

TBA-70 security device, backset 2 3/4"

A8 TBA-80 antiscasso, entrata mm 80

TBA-80 security device, backset 3 5/32"

06 TB-060 bordo in acciaio, entrata mm 60

TB-060 steel edge, backset 2 23/64"

07 TB-070 bordo in acciaio, entrata mm 70

TB-070 steel edge, backset 2 3/4"

08 TB-080 bordo in acciaio, entrata mm 80

TB-080 steel edge, backset 3 5/32"

6M TBM-60 bordo mm 25 tondo magnetico

TBM-60 edge backset 2 23/64" magnetic

7M TBM-70 bordo mm 25 tondo magnetico

TBM-70 edge backset 2 3/4" magnetic

BORDO SCROCCO

LATCH FOREND

Quadro

Squared

T Tondo

Round

Larghezza mm 22

Width 55/64"

CIFRATURE

KEY-CHANGES

KD chiavi differenti

KD keyed differently

A **KA** chiavi uguali

KA keyed alike

M **MK** chiave maestra

MK master key

G **GMK** chiave maestra generale

GMK general master key

K **GGMK** chiave gran maestra generale

GGMK grand general master key

SPessori PORTE

DOOR THICKNESS

mm 32 ÷ 60

1 17/64" ÷ 2 23/64"

+ mm 60 ÷ 70

2 23/64" ÷ 2 3/4"

> > mm 70

> 2 3/4"

CONTROBORDI

STRIKING PLATE

Senza controbordo

Without striking plate

P875 quadro

P875 square

T **P875/T** arrotondato

P875/T round-edge

1 **P896** rifilato

P896 without forend

1T **P896/T** rifilato arrotondato

P896/T without forend, round-edge

91 **P1291/R** nylon nero regolabile

P1291/R adjustable, black nylon

ACCESSORI FORMA PER VETRO FORMA GLASS ACCESSORIES

SERIE
F

FGLA 70



FGLA
NA
NE
BO
GR
3
4K
15
26
6D

Scrocco con antiscasso per porte vetro

FINITURE

Verniciato argento
 Verniciato nero
 Verniciato bianco
 Grigio
 Oro lucido (US3)
 Oro opaco (24K)
 Nickel opaco (US15)
 Cromo lucido (US26)
 Cromo opaco (US26D)

Latch with security device for glass doors

FINISHES

Silver coating
 Black coating
 White coating
 Grey
 Polish gold (US3)
 Matt gold (24K)
 Matt nickel (US15)
 Polish chrome (US26)
 Matt chrome (US26D)

FGL 1



FGL1
NA
NE
BO
GR
3
4K
15
26
6D

Piastra controbordo per porte vetro

FINITURE

Verniciato argento
 Verniciato nero
 Verniciato bianco
 Grigio
 Oro lucido (US3)
 Oro opaco (24K)
 Nickel opaco (US15)
 Cromo lucido (US26)
 Cromo opaco (US26D)

Striking plate for double glass doors

FINISHES

Silver coating
 Black coating
 White coating
 Grey
 Polish gold (US3)
 Matt gold (24K)
 Matt nickel (US15)
 Polish chrome (US26)
 Matt chrome (US26D)

FGLR



FGLR
NA
NE

Scrocco per porta vetro con profilo in alluminio

FINITURE

Verniciato argento
 Verniciato nero

Latch for glass doors with aluminium profile

FINISHES

Silver coating
 Black coating

FGLAD



FGLAD
84
NE
GR

Adattatore porte vetro con profilo in alluminio

DIMENSIONI

mm 41
 mm 84

FINITURE

Verniciato nero
 Grigio

Glass door adapter with aluminium profile

€ 4,00

SIZE

mm 41
 Grey

FINISHES

Black coating
 Grey

SERIE
F

ACCESSORI FORMA FORMA ACCESSORIES

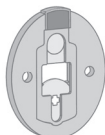
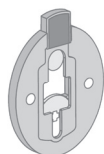

FSG

Segnalatore di occupato

Occupancy indicator

Polimero grigio

Polymer grey

12

Art.12 mm 61x50

Art.12 2 13/32" x 1 31/32"

24

Art.24 mm 61x50

Art.24 2 13/32" x 1 31/32"

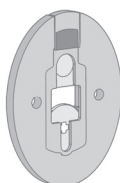
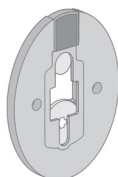

FROSESG

Rosetta segnalatore

Rose/Occupancy indicator

Polimero grigio

Polymer grey

12

Art.12 mm 75x58

Art.12 2 61/64" x 2 9/32"

24

Art.24 mm 75x58

Art.24 2 61/64" x 2 9/32"

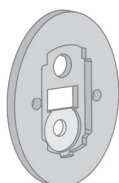

FROSE

Rosetta

Rose

Polimero grigio

Polymer grey

mm 75x58

2 61/64" x 2 9/32"

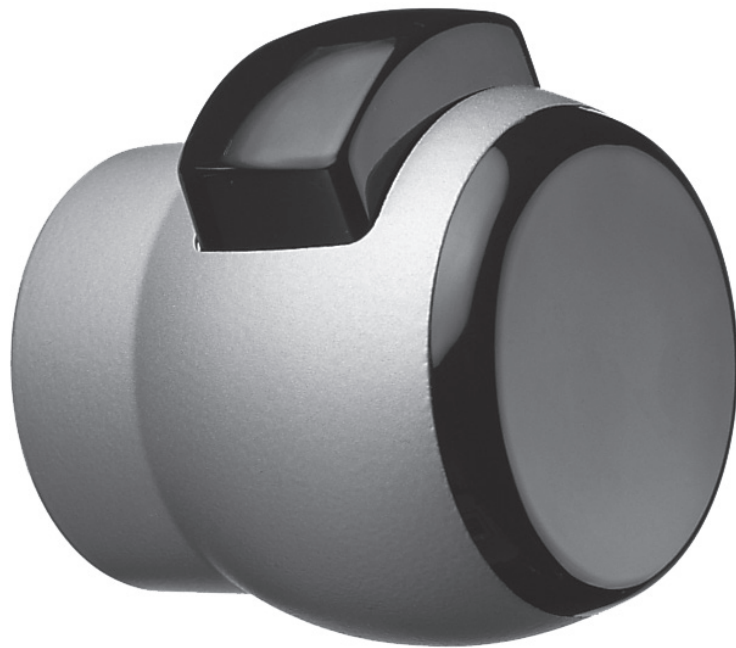

NOVA

info e preventivi
<http://www.bellittiserrature.it/contact.asp>



esterno
outside



interno
inside

N11 PER LOCALI DI PASSAGGIO FOR PASSAGEWAYS

SERIE
N

FUNZIONE

Entrambi i pulsanti sempre azionabili.

FUNCTION

Outside and inside push-buttons for free passage.

N11 11/NOVA senza scrocco senza controbordo

11/NOVA without latch, without striking plate

FINITURE

BO	Verniciato bianco
NA	Verniciato argento
NE	Verniciato nero
PE	Verniciato grigio perla
3	Ottone lucido (US3)
4	Ottone satinato (US4)
26	Ottone cromo lucido (US26)
6D	Ottone cromo satinato (US26D)
2B	Acciaio inox satinato

FINISHES

White coating
Silver coating
Black coating
Pearl grey coating
Polish brass (US3)
Satin brass (US4)
Polish chrome brass (US26)
Satin chrome brass (US26D)
Satin stainless steel

G Adatto per GL

Suitable to GL

SCROCCO

S	Senza scrocco
T7	TB-60 entrata mm 60 (standard)
T8	TB-70 entrata mm 70
T9	TB-80 entrata mm 80
A6	TB-127 entrata mm 127
A7	TBA-60 antiscasso, entrata mm 60
A8	TBA-70 antiscasso, entrata mm 70
06	TBA-80 antiscasso, entrata mm 80
07	TB-060 bordo in acciaio, entrata mm 60
08	TB-070 bordo in acciaio, entrata mm 70
6M	TB-080 bordo in acciaio, entrata mm 80
7M	TBM-60 bordo mm 25 tondo magnetico
	TBM-70 bordo mm 25 tondo magnetico

TUBULAR LATCH

Without tubular latch
TB-60 backset 2 23/64" (standard)
TB-70 backset 2 3/4"
TB-80 backset 3 5/32"
TB-127 backset 5 1/64"
TBA-60 security device, backset 2 23/64"
TBA-70 security device, backset 2 3/4"
TBA-80 security device, backset 3 5/32"
TB-060 steel edge, backset 2 23/64"
TB-070 steel edge, backset 2 3/4"
TB-080 steel edge, backset 3 5/32"
TBM-60 edge backset 2 23/64" magnetic
TBM-70 edge backset 2 3/4" magnetic

BORDO SCROCCO

T	Quadro
	Tondo

LATCH FOREND

Squared
Round

Larghezza mm 22

Width 55/64"

SPessori PORTE

	mm 32 ÷ 60
+	mm 60 ÷ 70
>	> mm 70

DOOR THICKNESS

1 17/64" ÷ 2 23/64"
2 23/64" ÷ 2 3/4"
> 2 3/4"

CONTROBORDI

C	Senza controbordo
T	P875 standard, quadro
1	P875/T arrotondato
1T	P896 refilato
91	P896/T refilato, arrotondato
	P1291/R nylon nero, regolabile

STRIKING PLATE

Without striking plate
P875 standard, squared
P875/T round-edge
P896 without forend
P896/T without forend, round-edge
P1291/R adjustable, black nylon

NOVA

SERIE
N

N12 PER BAGNO FOR BATHROOMS



esterno
 outside

interno
 inside

FUNZIONE

Apertura esterna con chiave d'emergenza, moneta, cacciavite, o qualsiasi attrezzo simile.
 Pomolo interno con girevole che aziona il segnalatore di occupato se utilizzato.

FUNCTION

Unlocked from outside by emergency key, coin, screw-driver or any other similar tool.
 Inside knob with thumbturn acting on occupancy indicator if provided.

N12 12/NOVA senza scrocco senza controbordo

12/NOVA without latch, without striking plate

A Dispositivo di emergenza Emergency device

FINITURE

FINISHES

BO	Verniciato bianco	White coating
NA	Verniciato argento	Silver coating
NE	Verniciato nero	Black coating
PE	Verniciato grigio perla	Pearl grey coating
3	Ottone lucido (US3)	Polish brass (US3)
4	Ottone satinato (US4)	Satin brass (US4)
26	Ottone cromo lucido (US26)	Polish chrome brass (US26)
6D	Ottone cromo satinato (US26D)	Satin chrome brass (US26D)
2B	Acciaio inox satinato	Satin stainless steel

G Adatto per GL Suitable to GL

SCROCCO

TUBULAR LATCH

S	Senza scrocco	Without tubular latch
T7	TB-60 entrata mm 60 (standard)	TB-60 backset 2 23/64" (standard)
T8	TB-70 entrata mm 70	TB-70 backset 2 3/4"
T9	TB-80 entrata mm 80	TB-80 backset 3 5/32"
A6	TB-127 entrata mm 127	TB-127 backset 5 1/64"
A7	TBA-60 antiscasso, entrata mm 60	TBA-60 security device, backset 2 23/64"
A8	TBA-70 antiscasso, entrata mm 70	TBA-70 security device, backset 2 3/4"
06	TBA-80 antiscasso, entrata mm 80	TBA-80 security device, backset 3 5/32"
07	TB-060 bordo in acciaio, entrata mm 60	TB-060 steel edge, backset 2 23/64"
08	TB-070 bordo in acciaio, entrata mm 70	TB-070 steel edge, backset 2 3/4"
08	TB-080 bordo in acciaio, entrata mm 80	TB-080 steel edge, backset 3 5/32"
6M	TBM-60 bordo mm 25 tondo magnetico	TBM-60 edge backset 2 23/64" magnetic
7M	TBM-70 bordo mm 25 tondo magnetico	TBM-70 edge backset 2 3/4" magnetic

BORDO SCROCCO

LATCH FOREND

T	Quadro Squared
	Tondo Round

Larghezza mm 22 Width 55/64"

SPESSORI PORTE

DOOR THICKNESS

	mm 32 ÷ 60	1 17/64" ÷ 2 23/64"
+	mm 60 ÷ 70	2 23/64" ÷ 2 3/4"
>	> mm 70	> 2 3/4"

CONTROBORDI

STRIKING PLATE

C	Senza controbordo	Without striking plate
	P875 standard, quadro	P875 standard, squared
T	P875/T arrotondato	P875/T round-edge
1	P896 rifilato	P896 without forend
1T	P896/T rifilato, arrotondato	P896/T without forend, round-edge
91	P1291/R nylon nero, regolabile	P1291/R adjustable, black nylon



esterno
outside



interno
inside

N13 PER INGRESSO E UFFICI FOR ENTRANCES AND OFFICES

SERIE
N

FUNZIONE

Bloccabile o sbloccabile dall'esterno con chiave.
 Pomolo interno con girevole.

FUNCTION

Locked or unlocked from outside by key.
 Inside knob with turnthumb.

N13 13/NOVA senza scrocco senza controbordo

13/NOVA without latch, without striking plate

FINITURE

BO	Verniciato bianco
NA	Verniciato argento
NE	Verniciato nero
PE	Verniciato grigio perla
3	Ottone lucido (US3)
4	Ottone satinato (US4)
26	Ottone cromo lucido (US26)
6D	Ottone cromo satinato
2B	Acciaio inox satinato

FINISHES

White coating
Silver coating
Black coating
Pearl grey coating
Polish brass (US3)
Satin brass (US4)
Polish chrome brass (US26)
Satin chrome brass (US26D)
Satin stainless steel

G Adatto per GL

Suitable to GL

SCROCCO

S	Senza scrocco
T7	TB-60 entrata mm 60 (standard)
T8	TB-70 entrata mm 70
T9	TB-80 entrata mm 80
A6	TB-127 entrata mm 127
A7	TBA-60 antiscasso, entrata mm 60
A8	TBA-70 antiscasso, entrata mm 70
06	TBA-80 antiscasso, entrata mm 80
07	TB-060 bordo in acciaio entrata mm 60
08	TB-070 bordo in acciaio, entrata mm 70
6M	TB-080 bordo in acciaio, entrata mm 80
7M	TBM-60 bordo mm 25 tondo magnetico
	TBM-70 bordo mm 25 tondo magnetico

TUBULAR LATCH

Without tubular latch
TB-60 backset 2 23/64" (standard)
TB-70 backset 2 3/4"
TB-80 backset 3 5/32"
TB-127 backset 5 1/64"
TBA-60 security device, backset 2 23/64"
TBA-70 security device, backset 2 3/4"
TBA-80 security device, backset 3 5/32"
TB-060 steel edge, backset 2 23/64"
TB-070 steel edge, backset 2 3/4"
TB-080 steel edge, backset 3 5/32"
TBM-60 edge backset 2 23/64" magnetic
TBM-70 edge backset 2 3/4" magnetic

BORDO SCROCCO

T	Quadro
	Tondo

LATCH FOREND

Squared
Round

Larghezza mm 22

Width 55/64"

CIFRATURE

A	KD chiavi differenti
M	KA chiavi uguali
G	MK chiave maestra
K	GMK chiave maestra generale
	GGMK chiave gran maestra generale

KEY-CHANGES

KD keyed differently
KA keyed alike
MK master key
GMK general master key
GGMK grand general master key

SPESSORI PORTE

+	mm 32 ÷ 60
>	mm 60 ÷ 70
	> mm 70

DOOR THICKNESS

1 17/64" ÷ 2 23/64"
2 23/64" ÷ 2 3/4"
> 2 3/4"

CONTROBORDI

C	Senza controbordo
T	P875 standard, quadro
1	P875/T arrotondato
1T	P896 refilato
91	P896/T refilato, arrotondato
	P1291/R nylon nero regolabile

STRIKING PLATE

Without striking plate
P875 standard, squared
P875/T round-edge
P896 without forend
P896/T without forend, round-edge
P1291/R adjustable, black nylon

SERIE
N

N14 PER CAMERE D'ALBERGO FOR HOTEL ROOMS

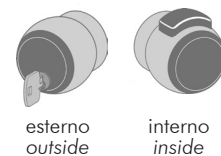

FUNZIONE

Pomolo esterno senza pulsante con piastra di sicurezza.

Apertura solo con chiave.

Pulsante interno sempre azionabile.

FUNCTION

Outside knob without push-button, with security plate.

Unlocked only from outside by key.

Inside push-button for free passage.

N14

14/NOVA senza scrocco senza controbordo

14/NOVA without latch, without striking plate

FINITURE

BO
NA
NE
PE
3
4
26
6D
2B

Verniciato bianco
 Verniciato argento
 Verniciato nero
 Verniciato grigio perla
 Ottone lucido (US3)
 Ottone satinato (US4)
 Ottone cromo lucido (US26)
 Ottone cromo satinato
 Acciaio inox satinato

FINISHES

White coating
 Silver coating
 Black coating
 Pearl grey coating
 Polish brass (US3)
 Satin brass (US4)
 Polish chrome brass (US26)
 Satin chrome brass (US26D)
 Satin stainless steel

G

Adatto per GL

Suitable to GL

SCROCCO

S
T7
T8
T9
A6
A7
A8
06
07
08
6M
7M

Senza scrocco
 TB-60 entrata mm 60 (standard)
 TB-70 entrata mm 70
 TB-80 entrata mm 80
 TB-127 entrata mm 127
 TBA-60 antiscasso, entrata mm 60
 TBA-70 antiscasso, entrata mm 70
 TBA-80 antiscasso, entrata mm 80
 TB-060 bordo in acciaio entrata mm 60
 TB-070 bordo in acciaio, entrata mm 70
 TB-080 bordo in acciaio, entrata mm 80
 TBM-60 bordo mm 25 tondo magnetico
 TBM-70 bordo mm 25 tondo magnetico

TUBULAR LATCH

Without tubular latch
 TB-60 backset 2 23/64" (standard)
 TB-70 backset 2 3/4"
 TB-80 backset 3 5/32"
 TB-127 backset 5 1/64"
 TBA-60 security device, backset 2 23/64"
 TBA-70 security device, backset 2 3/4"
 TBA-80 security device, backset 3 5/32"
 TB-060 steel edge, backset 2 23/64"
 TB-070 steel edge, backset 2 3/4"
 TB-080 steel edge, backset 3 5/32"
 TBM-60 edge backset 2 23/64" magnetic
 TBM-70 edge backset 2 3/4" magnetic

BORDO SCROCCO

T

Quadro
 Tondo

LATCH FOREND

Squared
 Round

Larghezza mm 22

Width 55/64"

CIFRATURE

A
M
G
K

KD chiavi differenti
 KA chiavi uguali
 MK chiave maestra
 GMK chiave maestra generale
 GGМК chiave gran maestra generale

KEY-CHANGES

KD keyed differently
 KA keyed alike
 MK master key
 GMK general master key
 GGМК grand general master key

SPessori PORTE

+
>

mm 32 ÷ 60
 mm 60 ÷ 70
 > mm 70

DOOR THICKNESS

1 17/64" ÷ 2 23/64"
 2 23/64" ÷ 2 3/4"
 > 2 3/4"

CONTROBORDI

C
T
1
1T
91

Senza controbordo
 P875 standard, quadro
 P875/T arrotondato
 P896 rifilato
 P896/T rifilato, arrotondato
 P1291/R nylon nero regolabile

STRIKING PLATE

Without striking plate
 P875 standard, squared
 P875/T round-edge
 P896 without forend
 P896/T without forend, round-edge
 P1291/R adjustable, black nylon



esterno
outside



interno
inside

N15 PER INGRESSO E UFFICI FOR ENTRANCES AND OFFICES

SERIE
N

FUNZIONE

FUNCTION

Locked or unlocked from both sides
by key.

N15 15/NOVA senza scrocco senza controbordo

15/NOVA without latch, without striking plate

FINITURE

FINISHES

BO	Verniciato bianco	White coating
NA	Verniciato argento	Silver coating
NE	Verniciato nero	Black coating
PE	Verniciato grigio perla	Pearl grey coating
3	Ottone lucido (US3)	Polish brass (US3)
4	Ottone satinato (US4)	Satin brass (US4)
26	Ottone cromo lucido (US26)	Polish chrome brass (US26)
6D	Ottone cromo satinato	Satin chrome brass (US26D)
2B	Acciaio inox satinato	Satin stainless steel

G Adatto per GL

Suitable to GL

SCROCCO

TUBULAR LATCH

S	Senza scrocco	Without tubular latch
TB-60	entrata mm 60 (standard)	backset 2 23/64" (standard)
TB-70	entrata mm 70	backset 2 3/4"
TB-80	entrata mm 80	backset 3 5/32"
T9	entrata mm 127	backset 5 1/64"
A6	antiscasso, entrata mm 60	security device, backset 2 23/64"
A7	antiscasso, entrata mm 70	security device, backset 2 3/4"
A8	antiscasso, entrata mm 80	security device, backset 3 5/32"
06	borco in acciaio entrata mm 60	steel edge, backset 2 23/64"
07	borco in acciaio, entrata mm 70	steel edge, backset 2 3/4"
08	borco in acciaio, entrata mm 80	steel edge, backset 3 5/32"
6M	borco mm 25 tondo magnetico	edge backset 2 23/64" magnetic
7M	borco mm 25 tondo magnetico	edge backset 2 3/4" magnetic

BORDO SCROCCO

LATCH FOREND

T	Quadro	Squared
	Tondo	Round

Larghezza mm 22

Width 55/64"

CIFRATURE

KEY-CHANGES

A	KD chiavi differenti	keyed differently
M	KA chiavi uguali	keyed alike
G	MK chiave maestra	master key
K	GMK chiave maestra generale	general master key
	GGMK chiave gran maestra generale	grand general master key

SPessori PORTE

DOOR THICKNESS

	mm 32 ÷ 60	1 17/64" ÷ 2 23/64"
+	mm 60 ÷ 70	2 23/64" ÷ 2 3/4"
>	> mm 70	> 2 3/4"

CONTROBORDI

STRIKING PLATE

C	Senza controbordo	Without striking plate
T	P875 standard, quadro	P875 standard, squared
1	P875/T arrotondato	P875/T round-edge
1T	P896 rifilato	P896 without forend
91	P896/T rifilato, arrotondato	P896/T without forend, round-edge
	P1291/R nylon nero regolabile	P1291/R adjustable, black nylon

SERIE
N

N17 PER AULE SCOLASTICHE E UFFICI FOR CLASSROOMS AND OFFICES

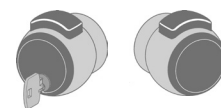

esterno
outside

interno
inside

FUNZIONE

Bloccabile o sbloccabile dall'esterno con chiave.
 Pulsante interno sempre azionabile.

FUNCTION

Locked or unlocked from outside by key.
 Inside push-button for free passage.

N17 17/NOVA senza scrocco senza controbordo

17/NOVA without latch, without striking plate

FINITURE

BO	Verniciato bianco
NA	Verniciato argento
NE	Verniciato nero
PE	Verniciato grigio perla
3	Ottone lucido (US3)
4	Ottone satinato (US4)
26	Ottone cromo lucido (US26)
6D	Ottone cromo satinato
2B	Acciaio inox satinato

FINISHES

White coating
Silver coating
Black coating
Pearl grey coating
Polish brass (US3)
Satin brass (US4)
Polish chrome brass (US26)
Satin chrome brass (US26D)
Satin stainless steel

G Adatto per GL

Suitable to GL

SCROCCO

S	Senza scrocco
T7	TB-60 entrata mm 60 (standard)
T8	TB-70 entrata mm 70
T9	TB-80 entrata mm 80
A6	TB-127 entrata mm 127
A7	TBA-60 antiscasso, entrata mm 60
A8	TBA-70 antiscasso, entrata mm 70
06	TBA-80 antiscasso, entrata mm 80
07	TB-060 bordo in acciaio entrata mm 60
08	TB-070 bordo in acciaio, entrata mm 70
6M	TB-080 bordo in acciaio, entrata mm 80
7M	TBM-60 bordo mm 25 tondo magnetico
	TBM-70 bordo mm 25 tondo magnetico

TUBULAR LATCH

Without tubular latch
TB-60 backset 2 23/64" (standard)
TB-70 backset 2 3/4"
TB-80 backset 3 5/32"
TB-127 backset 5 1/64"
TBA-60 security device, backset 2 23/64"
TBA-70 security device, backset 2 3/4"
TBA-80 security device, backset 3 5/32"
TB-060 steel edge, backset 2 23/64"
TB-070 steel edge, backset 2 3/4"
TB-080 steel edge, backset 3 5/32"
TBM-60 edge backset 2 23/64" magnetic
TBM-70 edge backset 2 3/4" magnetic

BORDO SCROCCO

T	Quadro
	Tondo

LATCH FOREND

Squared
Round

Larghezza mm 22

Width 55/64"

CIFRATURE

A	KD chiavi differenti
M	KA chiavi uguali
G	MK chiave maestra
K	GMK chiave maestra generale
	GGMK chiave gran maestra generale

KEY-CHANGES

KD keyed differently
KA keyed alike
MK master key
GMK general master key
GGMK grand general master key

SPessori PORTE

+	mm 32 ÷ 60
>	mm 60 ÷ 70
	> mm 70

DOOR THICKNESS

1 17/64" ÷ 2 23/64"
2 23/64" ÷ 2 3/4"
> 2 3/4"

CONTROBORDI

C	Senza controbordo
T	P875 standard, quadro
1	P875/T arrotondato
1T	P896 rifilato
91	P896/T rifilato, arrotondato
	P1291/R nylon nero regolabile

STRIKING PLATE

Without striking plate
P875 standard, squared
P875/T round-edge
P896 without forend
P896/T without forend, round-edge
P1291/R adjustable, black nylon

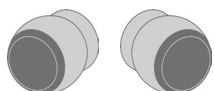

esterno
outside

interno
inside

N20 APPLICAZIONI VARIE DIFFERENT APPLICATIONS

SERIE
N

FUNZIONE

Doppia impugnatura fissa senza pulsante.

FUNCTION

Double fixed knob.

N20

20/NOVA

20/NOVA

FINITURE

BO	Verniciato bianco
NA	Verniciato argento
NE	Verniciato nero
PE	Verniciato grigio perla
3	Ottone lucido (US3)
4	Ottone satinato (US4)
26	Ottone cromo lucido (US26)
6D	Ottone cromo satinato (US26D)
2B	Acciaio inox satinato

FINISHES

White coating
Silver coating
Black coating
Pearl grey coating
Polish brass (US3)
Satin brass (US4)
Polish chrome brass (US26)
Satin chrome brass (US26D)
Satin stainless steel

NOVA

SERIE
N

N21

APPLICAZIONI VARIE
DIFFERENT APPLICATIONS

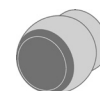

esterno
outside

FUNZIONE

Impugnatura esterna fissa senza pulsante.

FUNCTION

Outside fixed knob.

N21

21/NOVA

21/NOVA

FINITURE

FINISHES

BO	Verniciato bianco	White coating
NA	Verniciato argento	Silver coating
NE	Verniciato nero	Black coating
PE	Verniciato grigio perla	Pearl grey coating
3	Ottone lucido (US3)	Polish brass (US3)
4	Ottone satinato (US4)	Satin brass (US4)
26	Ottone cromo lucido (US26)	Polish chrome brass (US26)
6D	Ottone cromo satinato (US26D)	Satin chrome brass (US26D)
2B	Acciaio inox satinato	Satin stainless steel



esterno
outside



interno
inside

N24 PER CAMERE D'ALBERGO FOR HOTEL ROOMS

SERIE
N

FUNZIONE

Pomolo esterno senza pulsante, apertura solo con chiave.

Pomolo interno con girevole che aziona il segnalatore di occupato se utilizzato.

FUNCTION

Outside knob without push-button, unlocked only by key.

Inside knob with thumbturn acting on occupancy indicator if provided.

N24

24/NOVA senza scrocco senza controbordo

24/NOVA without latch, without striking plate

A

Dispositivo di emergenza

Emergency device

FINITURE

Verniciato bianco

Verniciato argento

Verniciato nero

Verniciato grigio perla

Ottone lucido (US3)

Ottone satinato (US4)

Ottone cromo lucido (US26)

Ottone cromo satinato

Acciaio inox satinato

FINISHES

White coating

Silver coating

Black coating

Pearl grey coating

Polish brass (US3)

Satin brass (US4)

Polish chrome brass (US26)

Satin chrome brass (US26D)

Satin stainless steel

G

Adatto per GL

Suitable to GL

SCROCCO

Senza scrocco

TB-60 entrata mm 60 (standard)

TB-70 entrata mm 70

TB-80 entrata mm 80

TB-127 entrata mm 127

TBA-60 antiscasso, entrata mm 60

TBA-70 antiscasso, entrata mm 70

TBA-80 antiscasso, entrata mm 80

TB-060 bordo in acciaio entrata mm 60

TB-070 bordo in acciaio, entrata mm 70

TB-080 bordo in acciaio, entrata mm 80

TBM-60 bordo mm 25 tondo magnetico

TBM-70 bordo mm 25 tondo magnetico

TUBULAR LATCH

Without tubular latch

TB-60 backset 2 23/64" (standard)

TB-70 backset 2 3/4"

TB-80 backset 3 5/32"

TB-127 backset 5 1/64"

TBA-60 security device, backset 2 23/64"

TBA-70 security device, backset 2 3/4"

TBA-80 security device, backset 3 5/32"

TB-060 steel edge, backset 2 23/64"

TB-070 steel edge, backset 2 3/4"

TB-080 steel edge, backset 3 5/32"

TBM-60 edge backset 2 23/64" magnetic

TBM-70 edge backset 2 3/4" magnetic

BORDO SCROCCO

Quadro

Tondo

LATCH FOREND

Squared

Round

Larghezza mm 22

Width 55/64"

CIFRATURE

KD chiavi differenti

KA chiavi uguali

MK chiave maestra

GMK chiave maestra generale

GGMK chiave gran maestra generale

KEY-CHANGES

KD keyed differently

KA keyed alike

MK master key

GMK general master key

GGMK grand general master key

SPESSORI PORTE

mm 32 ÷ 60

mm 60 ÷ 70

> mm 70

DOOR THICKNESS

1 17/64" ÷ 2 23/64"

2 23/64" ÷ 2 3/4"

> 2 3/4"

CONTROBORDI

Senza controbordo

P875 standard, quadro

P875/T arrotondato

P896 refilato

P896/T refilato, arrotondato

P1291/R nylon nero regolabile

STRIKING PLATE

Without striking plate

P875 standard, squared

P875/T round-edge

P896 without forend

P896/T without forend, round-edge

P1291/R adjustable, black nylon

C

T

1

1T

91

GLA 70

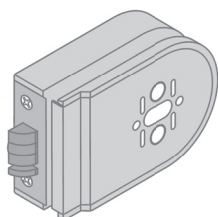

NGLA

**Scrocco con anticasso
per porte vetro**

**Latch with security device
for glass doors**

NA

Verniciato argento

FINISHES

Silver coating

NE

Verniciato nero

Black coating

3

Ottone lucido (US3)

Polish brass (US3)

4

Ottone satinato (US4)

Satin brass (US4)

26

Ottone cromo lucido (US26)

Polish chrome brass (US26)

6D

Ottone cromo satinato (US26D)

Satin chrome brass (US26D)

GL 1

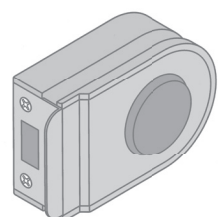

NGL1

**Piastra controbordo
per porte vetro**

**Striking plate
for double glass doors**

NA

Verniciato argento

FINISHES

Silver coating

NE

Verniciato nero

Black coating

3

Ottone lucido (US3)

Polish brass (US3)

4

Ottone satinato (US4)

Satin brass (US4)

26

Ottone cromo lucido (US26)

Polish chrome brass (US26)

6D

Ottone cromo satinato (US26D)

Satin chrome brass (US26D)

NSG

Segnalatore di occupato

Occupancy indicator



NA

Verniciato argento

FINISHES

Silver coating

NE

Verniciato nero

Black coating

3

Ottone lucido (US3)

Polish brass (US3)

4

Ottone satinato (US4)

Satin brass (US4)

26

Ottone cromo lucido (US26)

Polish chrome brass (US26)

6D

Ottone cromo satinato (US26D)

Satin chrome brass (US26D)

1071



NROSE1071

Rosetta

Polimero nero

Rose

Polymer black

1216



NROSE1216

Rosetta

Polimero nero

Rose

Polymer black

M01A

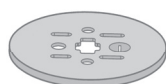

NM01N

Rosetta

Polimero nero e metallo

Rose

Polymer black and metal

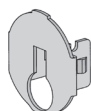

NPIFRO

Piastra di sicurezza

Acciaio zincato

Safety plate

Zinc plated steel

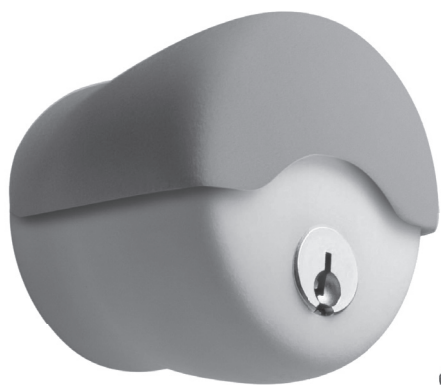

COMBINA



FORMA

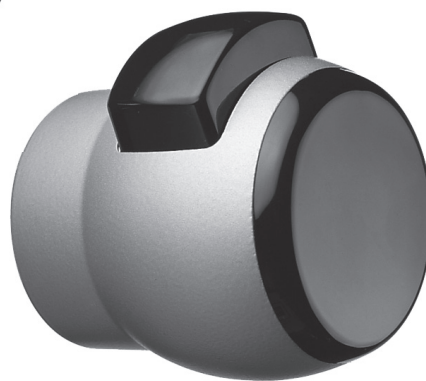

NOVA

info e preventivi
<http://www.bellittiserrature.it/contact.asp>

CONTROBORDI STRIKING PLATES

SERIE
KFN

P875

NCBP875

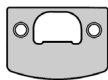

4

15

Controbordo quadro (standard)

Ottone

FINITURE

Ottone decapato (US4)

Ottone nichelato (US15)

Square striking plate (standard)

Brass

FINISHES

Pickled brass (US4)

Nickel plated brass (US15)

P875/T

NCBP875T

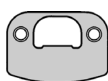

4

15

Controbordo tondo

Ottone

FINITURE

Ottone decapato (US4)

Ottone nichelato (US15)

Round-edge striking plate

Brass

FINISHES

Pickled brass (US4)

Nickel plated brass (US15)

P896

NCBP896

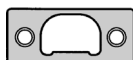

4

15

Controbordo refilato quadro per porte con battuta

Ottone

FINITURE

Ottone decapato (US4)

Ottone nichelato (US15)

Square striking plate without forend for rebated doors

Brass

FINISHES

Pickled brass (US4)

Nickel plated brass (US15)

P896/T

NCBP896T

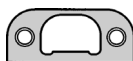

4

15

Controbordo refilato tondo per porte con battuta

Ottone

FINITURE

Ottone decapato (US4)

Ottone nichelato (US15)

Round-edge striking plate without forend for rebated doors

Brass

FINISHES

Pickled brass (US4)

Nickel plated brass (US15)

P1047

NCBP1047

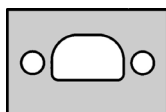

4

15

Controbordo rettangolare piano

Ottone

FINITURE

Ottone decapato (US4)

Ottone nichelato (US15)

Flat rectangular striking plate

Brass

FINISHES

Pickled brass (US4)

Nickel plated brass (US15)

SERIE
KFN

CONTROBORDI STRIKING PLATES

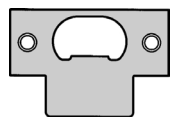

P1156

NCBP1156

Controbordo

Acciaio

Striking plate

Steel

FINITURE

Zincato

FINISHES

Zinc plated

Z



P1278

NCBP278

Controbordo a squadra

Acciaio

Square-edge striking plate

Steel

FINITURE

Nichelato (US15)

FINISHES

Nickel plated (US15)

15



P1613

NCBP1613

Controbordo

FINITURE

Nichelato (US15)

Striking plate

FINISHES

Nickel plated (US15)

15



P1036

NCBP1036

Controbordo

Polimero

COLORI

Nero

Striking plate

Polymer

COLOURS

Black



P1287

NCBP1287

**Controbordo per profilati
in alluminio**

Polimero

COLORI

Nero

**Striking plate
for aluminium profiles**

Polymer

COLOURS

Black

CONTROBORDI STRIKING PLATES

SERIE
KFN

P1288

NCBP1288



Controbordo per profilati
in alluminio

Striking plate
for aluminium profiles

Polimero

Polymer

COLORI

COLOURS

Nero

Black

P1289

NCBP1289



Controbordo per profilati
in alluminio

Striking plate
for aluminium profiles

Polimero

Polymer

COLORI

COLOURS

Nero

Black

P1290

NCBP1290



Controbordo per profilati
in alluminio

Striking plate
for aluminium profiles

Polimero

Polymer

COLORI

COLOURS

Nero

Black

P1291/R

NCBP1291R

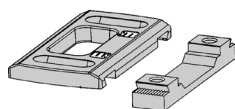

Controbordo regolabile
per profilati in alluminio

Adjustable striking plate
for aluminium profiles

Polimero nero

Black Polymer

SERIE
KFN

SOTTOBORDI FOREND UNDERPLATES

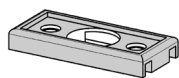

P2285

NDISCR2285

**Sottobordo per profilati
in alluminio**

Polimero nera

**Forend underplate
for aluminium profiles**

Black Polymer

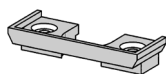

P2286

NDISCR2286

**Sottobordo per profilati
in alluminio**

Polimero nera

**Forend underplate
for aluminium profiles**

Black Polymer

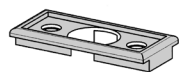

P2287

NDISCR2287

**Sottobordo per profilati
in alluminio**

Polimero nera

**Forend underplate
for aluminium profiles**

Black Polymer

TB

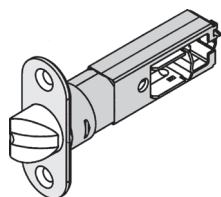
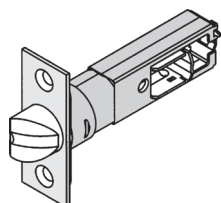

NTB

Scrocco tubolare

Bordo in acciaio

Tubular latch

Steel edge plate

60
60T
70
70T
80
80T
127
127T

ENTRATA

mm 60
 mm 60 tondo
 mm 70
 mm 70 tondo
 mm 80
 mm 80 tondo
 mm 127
 mm 127 tondo

BACKSET

2 3/8"
 2 3/8" Round plate
 2 3/4"
 2 3/4" Round plate
 3 1/8"
 3 1/8" Round plate
 5"
 5" Round plate

BORDO

Larghezza mm 22

25

Larghezza mm 25

FOREND PLATE

Width 55/64"

Width 63/64"

4

FINITURE

Acciaio ottonato (US4)
 Acciaio nichelato (US15)

FINISHES

Pickled steel (US4)
 Nickel plated steel (US15)

TBA

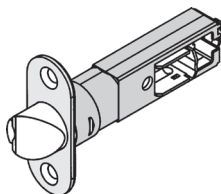
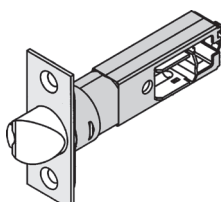

NTBA

Scrocco tubolare con anticasso

Bordo in acciaio

Tubular latch with security device

Steel edge plate

60
60T
70
70T
80
80T

ENTRATA

mm 60
 mm 60 tondo
 mm 70
 mm 70 tondo
 mm 80
 mm 80 tondo

BACKSET

2 3/8"
 2 3/8" Round plate
 2 3/4"
 2 3/4" Round plate
 3 1/8"
 3 1/8" Round plate

BORDO

Larghezza mm 22

25

Larghezza mm 25

FOREND PLATE

Width 55/64"

Width 63/64"

4

FINITURE

Acciaio ottonato (US4)
 Acciaio nichelato (US15)

FINISHES

Pickled steel (US4)
 Nickel plated steel (US15)

TB0

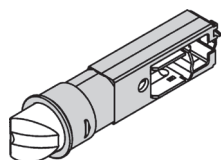

NTB0

Scrocco tubolare

Bordo in acciaio

Tubular latch

Steel edge plate

60
70
80

ENTRATA

mm 60
 mm 70
 mm 80

BACKSET

2 3/8"
 2 3/4"
 3 1/8"

TBM

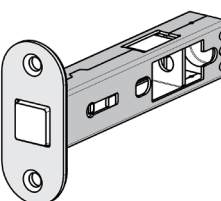

NTBM

Scrocco magnetico tubolare

Magnetic latch tubular

60T
70T

ENTRATA

mm 60 tondo
 mm 70 tondo

BACKSET

2 3/8" Round plate
 2 3/4" Round plate

25

BORDO

Larghezza mm 25

FOREND PLATE

Width 63/64"

15

FINITURE

Acciaio nichelato (US15)

FINISHES

Nickel steel (US15)

P900

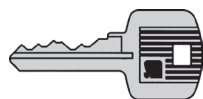

- NP900
- PS
- C
- CPS
- CC
- CCPS
- G

Chiave

Ottone nichelato

CIFRATURE

Grezza profilo standard
 Grezza profilo speciale
 Cifrata oltre la dotazione
 Cifrata oltre la dotazione
 Cifrata su codice o campione
 min 2 pz. profilo standard
 Cifrata su codice o campione
 min 2 pz. profilo speciale

CONFEZIONI

100 pz.

Key

Nickel plated brass

KEY-CHANGES

Blank standard profile
 Blank special profile
 Extra cut key standard profile
 Extra cut key special profile
 Extra cut key standard profile
 on code or sample min 2 pcs
 Extra cut key special profile
 on code or sample min 2 pcs

PACKAGING

Boxed in 100's

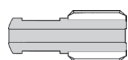

- NPRSPE70
- Z

Prolunga slitta (asimmetrica)

Acciaio

SPessori

mm 70

FINITURE

Zincato

Slide extension (asymmetrical)

Steel

THICKNESS

2 3/4"

FINISHES

Zinc plated

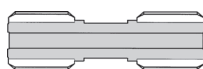

- NPRSPE>S
- Z

Prolunga slitta (simmetrica)

Acciaio

SPessori

> mm 70

FINITURE

Zincato

Slide extension (symmetrical)

Steel

THICKNESS

> 2 3/4"

FINISHES

Zinc plated

	EXTRA	EXTRA
	Cilindro speciale	Special cylinder
	Versione handicap (solo per serie NOVA)	Handicap version (only NOVA series)
	Versione antifuoco (omologato UL - ULC)	Fire version (tested UL - ULC)



pigio 1

info e preventivi
<http://www.bellittiserrature.it/contact.asp>

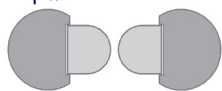

esterno
outside

interno
inside

P11 PER LOCALI DI PASSAGGIO FOR PASSAGEWAYS

ex Pigio A00

SERIE
P1

FUNZIONE

Entrambe le maniglie sempre azionabili.

FUNCTION

Outside and inside handles for free passage.

P11

Pigio 11 senza scrocco senza controbordo

Pigio 11 without latch, without striking plate

CG

Verniciato grigio chiaro

FINISHES

Light grey coating

DG

Verniciato grigio scuro

Dark grey coating

GF

Verniciato grafite

Graphite coating

VERSIONE

1

Pigio 1

VERSION

Pigio 1

FINITURE MANIGLIA

CG

ABS grigio chiaro

HANDLE FINISHES

ABS, light grey

NE

ABS nero

ABS, black

NG

Nero gommato

Rubber finish, black

ABO

Bianco (polimero antibatterico)

White (antibacterial polymer)

SCROCCO

S

Senza scrocco

TUBULAR LATCH

Without tubular latch

T6

TB-60 entrata mm 60 (standard)

TB-60 backset 2 23/64" (standard)

T7

TB-70 entrata mm 70

TB-70 backset 2 3/4"

T8

TB-80 entrata mm 80

TB-80 backset 3 5/32"

T127

TB-127 entrata mm 127

TB-127 backset 5 1/64"

A6

TBA-60 antiscasso, entrata mm 60

TBA-60 security device, backset 2 23/64"

A7

TBA-70 antiscasso, entrata mm 70

TBA-70 security device, backset 2 3/4"

A8

TBA-80 antiscasso, entrata mm 80

TBA-80 security device, backset 3 5/32"

BORDO SCROCCO

25

Larghezza mm 22

LATCH FOREND

Width 55/64"

Larghezza mm 25

Width 63/64"

Quadro

Square

T

Tondo

Round

CONTROBORDI

C

Senza controbordo

STRIKING PLATE

Without striking plate

Art.1215 quadro

Art.1215 square

10

Art.1210 tondo

Art.1210 round

11

Art.1211 quadro

Art.1211 square

12

Art.1212 tondo

Art.1212 round

91

Art.1291/R nylon nero regolabile

Art.1291/R adjustable, black nylon

ACCESSORI

GL

Set per legno

ACCESSORIES

Kit for wooden door

GA

Set per alluminio

Kit for aluminium door

GC

Set completo

Kit complete

SPessori PORTE

L

mm 30 ÷ 56 destro

DOOR THICKNESS

1 3/16" ÷ 2 13/64" right

mm 40 ÷ 70 destro

1 37/64" ÷ 2 3/4" right

SERIE
P1

P12 PER BAGNI FOR BATHROOMS

ex Pigio A30

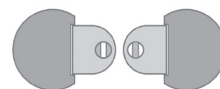

esterno
 outside

interno
 inside

FUNZIONE

Apertura esterna con moneta, cacciavite, o qualsiasi attrezzo simile.

Maniglia interna con girevole che aziona il segnalatore di occupato se utilizzato.

FUNCTION

Unlocked from outside by coin, screwdriver, or any other similar tool.

Inside handle with thumbturn acting on occupancy indicator if provided.

P12

Pigio 12 senza scrocco senza controbordo

Pigio 12 without latch, without striking plate

FINITURE

CG

Verniciato grigio chiaro

FINISHES

Light grey coating

DG

Verniciato grigio scuro

Dark grey coating

GF

Verniciato grafite

Graphite coating

VERSIONE

1

Pigio 1

VERSION

Pigio 1

FINITURE MANIGLIA

CG

ABS grigio chiaro

HANDLE FINISHES

ABS, light grey

NE

ABS nero

ABS, black

NG

Nero gommato

Rubber finish, black

ABO

Bianco (polimero antibatterico)

White (antibacterial polymer)

SCROCCO

S

Senza scrocco

TUBULAR LATCH

Without tubular latch

T6

TB-60 entrata mm 60 (standard)

TB-60 backset 2 23/64" (standard)

T7

TB-70 entrata mm 70

TB-70 backset 2 3/4"

T8

TB-80 entrata mm 80

TB-80 backset 3 5/32"

T127

TB-127 entrata mm 127

TB-127 backset 5 1/64"

A6

TBA-60 antiscasso, entrata mm 60

TBA-60 security device, backset 2 23/64"

A7

TBA-70 antiscasso, entrata mm 70

TBA-70 security device, backset 2 3/4"

A8

TBA-80 antiscasso, entrata mm 80

TBA-80 security device, backset 3 5/32"

BORDO SCROCCO

25

Larghezza mm 22

Larghezza mm 25

LATCH FOREND

Width 55/64"

Width 63/64"

Quadro

Square

T

Tondo

Round

CONTROBORDI

C

Senza controbordo

STRIKING PLATE

Without striking plate

10

Art.1215 quadro

Art.1215 square

11

Art.1210 tondo

Art.1210 round

11

Art.1211 quadro

Art.1211 square

12

Art.1212 tondo

Art.1212 round

91

Art.1291/R nylon nero regolabile

Art.1291/R adjustable, black nylon

ACCESSORI

GL

Set per legno

ACCESSORIES

Kit for wooden door

GA

Set per alluminio

Kit for aluminium door

GC

Set completo

Kit complete

SPESSORI PORTE

L

mm 30 ÷ 56 destro

DOOR THICKNESS

1 3/16" ÷ 2 13/64" right

mm 40 ÷ 70 destro

1 37/64" ÷ 2 3/4" right

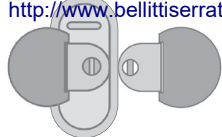

esterno
outside

interno
inside

P12E PER BAGNI FOR BATHROOMS

ex Pigio A37

SERIE
P1

FUNZIONE

Apertura esterna con moneta, cacciavite, o qualsiasi attrezzo simile.

Maniglia interna con girevole che aziona il segnalatore occupato

Con funzione di tipo antipanico UNI EN 179

FUNCTION

Unlocked from outside by coin, screwdriver or any other similar tool.

Inside handle with thumbturn acting on occupancy indicator

Anti-panic function UNI EN 179

Pigio 12/E without latch, without striking plate

P12E

Pigio 12/E senza scrocco senza controbordo

FINITURE

CG Verniciato grigio chiaro

DG Verniciato grigio scuro

GF Verniciato grafite

FINISHES

Light grey coating

Dark grey coating

Graphite coating

CG

DG

GF

VERSIONE

1 Pigio 1

VERSION

Pigio 1

1

FINITURE MANIGLIA

CG ABS grigio chiaro

NE ABS nero

NG Nero gommato

ABO Bianco (polimero antibatterico)

HANDLE FINISHES

ABS, light grey

ABS, black

Rubber finish, black

White (antibacterial polymer)

CG

NE

NG

ABO

SCROCCO

Senza scrocco

TUBULAR LATCH

Without tubular latch

S Senza scrocco

T6 TB-60 entrata mm 60 (standard)

T7 TB-70 entrata mm 70

T8 TB-80 entrata mm 80

T127 TB-127 entrata mm 127

A6 TBA-60 antiscasso, entrata mm 60

A7 TBA-70 antiscasso, entrata mm 70

A8 TBA-80 antiscasso, entrata mm 80

TB-60 backset 2 23/64" (standard)

TB-70 backset 2 3/4"

TB-80 backset 3 5/32"

TB-127 backset 5 1/64"

TBA-60 security device, backset 2 23/64"

TBA-70 security device, backset 2 3/4"

TBA-80 security device, backset 3 5/32"

S

T6

T7

T8

T127

A6

A7

A8

BORDO SCROCCO

Larghezza mm 22

Larghezza mm 25

LATCH FOREND

Width 55/64"

Width 63/64"

25

Quadro

Tondo

Square

Round

T

CONTROBORDI

Senza controbordo

Art.1215 quadro

Art.1210 tondo

Art.1211 quadro

Art.1212 tondo

Art.1291/R nylon nero regolabile

STRIKING PLATE

Without striking plate

Art.1215 square

Art.1210 round

Art.1211 square

Art.1212 round

Art.1291/R adjustable, black nylon

C

10

11

12

91

ACCESSORI

Set per legno

Set per alluminio Art. P12/E

Set completo

ACCESSORIES

Kit for wooden door

Kit for aluminium door Art. P12/E

Kit complete

GL

G37

GC

SPessori PORTE

mm 30 ÷ 56 destro

mm 40 ÷ 70 destro

DOOR THICKNESS

1 3/16" ÷ 2 13/64" right

1 37/64" ÷ 2 3/4" right

L

SERIE
P1

P13 PER INGRESSO E UFFICI FOR ENTRANCES AND OFFICES

ex Pigio A20

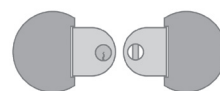

esterno
 outside

interno
 inside

FUNZIONE

Bloccabile o sbloccabile dall'esterno con chiave.
 Maniglia interna con girevole.

FUNCTION

Locked or unlocked from outside by key.
 Inside handle with thumbturn.

P13

Pigio 13 senza scrocco senza controbordo

Pigio 13 without latch, without striking plate

CG

Verniciato grigio chiaro

FINISHES

Light grey coating

DG

Verniciato grigio scuro

Dark grey coating

GF

Verniciato grafite

Graphite coating

VERSIONE

1

Pigio 1

VERSION

Pigio 1

FINITURE MANIGLIA

CG

ABS grigio chiaro

HANDLE FINISHES

ABS, light grey

NE

ABS nero

ABS, black

NG

Nero gommato

Rubber finish, black

ABO

Bianco (polimero antibatterico)

White (antibacterial polymer)

SCROCCO

S

Senza scrocco

TUBULAR LATCH

Without tubular latch

T6

TB-60 entrata mm 60 (standard)

TB-60 backset 2 23/64" (standard)

T7

TB-70 entrata mm 70

TB-70 backset 2 3/4"

T8

TB-80 entrata mm 80

TB-80 backset 3 5/32"

T127

TB-127 entrata mm 127

TB-127 backset 5 1/64"

A6

TBA-60 antiscasso, entrata mm 60

TBA-60 security device, backset 2 23/64"

A7

TBA-70 antiscasso, entrata mm 70

TBA-70 security device, backset 2 3/4"

A8

TBA-80 antiscasso, entrata mm 80

TBA-80 security device, backset 3 5/32"

BORDO SCROCCO

25

Larghezza mm 22

LATCH FOREND

Width 55/64"

Larghezza mm 25

Width 63/64"

Quadro

Square

T

Tondo

Round

CIFRATURE

A

KD chiavi differenti

KEY-CHANGES

KD keyed differently

M

KA chiavi uguali

KA keyed alike

G

MK chiave maestra

MK master key

K

GMK chiave maestra generale

GMK general master key

GGMK chiave gran maestra generale

GGMK grand general master key

CONTROBORDI

C

Senza controbordo

STRIKING PLATE

Without striking plate

10

Art.1215 quadro

Art.1215 square

11

Art.1210 tondo

Art.1210 round

12

Art.1211 quadro

Art.1211 square

91

Art.1212 tondo

Art.1212 round

Art.1291/R nylon nero regolabile

Art.1291/R adjustable, black nylon

ACCESSORI

GL

Set per legno

ACCESSORIES

Kit for wooden door

GA

Set per alluminio

Kit for aluminium door

GC

Set completo

Kit complete

SPESSORI PORTE

SX

mm 30 ÷ 56 destro

DOOR THICKNESS

1 3/16" ÷ 2 13/64" right

L

mm 30 ÷ 56 sinistro

1 3/16" ÷ 2 13/64" left

LSX

mm 40 ÷ 70 destro

1 37/64" ÷ 2 3/4" right

mm 40 ÷ 70 sinistro

1 37/64" ÷ 2 3/4" left

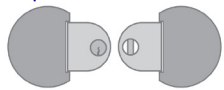

esterno
outside

interno
inside

P13E PER INGRESSO E UFFICI FOR ENTRANCES AND OFFICES

ex Pigio A25

SERIE
P1

FUNZIONE

Bloccabile o sbloccabile dall'esterno con chiave.
 Maniglia interna con girevole.

Con funzione di tipo antipanico UNI EN 179

FUNCTION

Locked or unlocked from outside by key.
 Inside handle with thumbturn.

Anti-panic function UNI EN 179

P13E

Pigio 13/E senza scrocco senza controbordo

Pigio 13/E without latch, without striking plate

CG

Verniciato grigio chiaro

FINISHES

Light grey coating

DG

Verniciato grigio scuro

Dark grey coating

GF

Verniciato grafite

Graphite coating

VERSIONE

Pigio 1

VERSION

Pigio 1

1

FINITURE MANIGLIA

ABS grigio chiaro

HANDLE FINISHES

ABS, light grey

CG

ABS nero

ABS, black

NE

Nero gommato

Rubber finish, black

NG

Bianco (polimero antibatterico)

White (antibacterial polymer)

ABO

SCROCCO

Senza scrocco

TUBULAR LATCH

Without tubular latch

S

T6

TB-60 entrata mm 60 (standard)

TB-60 backset 2 23/64" (standard)

T7

TB-70 entrata mm 70

TB-70 backset 2 3/4"

T8

TB-80 entrata mm 80

TB-80 backset 3 5/32"

T127

TB-127 entrata mm 127

TB-127 backset 5 1/64"

A6

TBA-60 antiscasso, entrata mm 60

TBA-60 security device, backset 2 23/64"

A7

TBA-70 antiscasso, entrata mm 70

TBA-70 security device, backset 2 3/4"

A8

TBA-80 antiscasso, entrata mm 80

TBA-80 security device, backset 3 5/32"

BORDO SCROCCO

Larghezza mm 22

LATCH FOREND

Width 55/64"

Larghezza mm 25

Width 63/64"

25

Quadro

Square

Tondo

Round

T

CIFRATURE

KD chiavi differenti

KEY-CHANGES

KD keyed differently

KA chiavi uguali

KA keyed alike

MK chiave maestra

MK master key

GMK chiave maestra generale

GMK general master key

GGMK chiave gran maestra generale

GGMK grand general master key

CONTROBORDI

Senza controbordo

STRIKING PLATE

Without striking plate

Art.1215 quadro

Art.1215 square

Art.1210 tondo

Art.1210 round

Art.1211 quadro

Art.1211 square

Art.1212 tondo

Art.1212 round

Art.1291/R nylon nero regolabile

Art.1291/R adjustable, black nylon

ACCESSORI

Set per legno

ACCESSORIES

Kit for wooden door

Set per alluminio

Kit for aluminium door

Set completo

Kit complete

SPESSORI PORTE

mm 30 ÷ 56 destro

DOOR THICKNESS

1 3/16" ÷ 2 13/64" right

mm 30 ÷ 56 sinistro

1 3/16" ÷ 2 13/64" left

mm 40 ÷ 70 destro

1 37/64" ÷ 2 3/4" right

mm 40 ÷ 70 sinistro

1 37/64" ÷ 2 3/4" left

GL

GA

GC

SX

L

LSX

SERIE
P1

P14 PER CAMERE D'ALBERGO FOR HOTEL ROOMS

ex Pigio A40

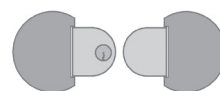

esterno
outside

interno
inside

FUNZIONE

Maniglia esterna sempre fissa, sbloccabile solo dall'esterno con chiave.

Maniglia interna sempre azionabile.

Con funzione di tipo antipanico UNI EN 179

FUNCTION

Fixed outside handle, unlocked only from outside by key.

Inside handle for free passage.

Anti-panic function UNI EN 179

P14

Pigio 14 senza scrocco senza controbordo

Pigio 14 without latch, without striking plate

CG

Verniciato grigio chiaro

FINISHES

Light grey coating

DG

Verniciato grigio scuro

Dark grey coating

GF

Verniciato grafite

Graphite coating

VERSIONE

1

Pigio 1

VERSION

Pigio 1

CG

ABS grigio chiaro

HANDLE FINISHES

ABS, light grey

NE

ABS nero

ABS, black

NG

Nero gommato

Rubber finish, black

ABO

Bianco (polimero antibatterico)

White (antibacterial polymer)

SCROCCO

S

Senza scrocco

TUBULAR LATCH

Without tubular latch

T6

TB-60 entrata mm 60 (standard)

TB-60 backset 2 23/64" (standard)

T7

TB-70 entrata mm 70

TB-70 backset 2 3/4"

T8

TB-80 entrata mm 80

TB-80 backset 3 5/32"

T127

TB-127 entrata mm 127

TB-127 backset 5 1/64"

A6

TBA-60 antiscasso, entrata mm 60

TBA-60 security device, backset 2 23/64"

A7

TBA-70 antiscasso, entrata mm 70

TBA-70 security device, backset 2 3/4"

A8

TBA-80 antiscasso, entrata mm 80

TBA-80 security device, backset 3 5/32"

BORDO SCROCCO

25

Larghezza mm 22

Larghezza mm 25

LATCH FOREND

Width 55/64"

Width 63/64"

Quadro

Square

T

Tondo

Round

CIFRATURE

A

KD chiavi differenti

KEY-CHANGES

KD keyed differently

M

KA chiavi uguali

KA keyed alike

G

MK chiave maestra

MK master key

K

GMK chiave maestra generale

GMK general master key

GGMK chiave gran maestra generale

GGMK grand general master key

CONTROBORDI

C

Senza controbordo

STRIKING PLATE

Without striking plate

10

Art.1215 quadro

Art.1215 square

11

Art.1210 tondo

Art.1210 round

12

Art.1211 quadro

Art.1211 square

91

Art.1212 tondo

Art.1212 round

Art.1291/R nylon nero regolabile

Art.1291/R adjustable, black nylon

ACCESSORI

GL

Set per legno

ACCESSORIES

Kit for wooden door

GA

Set per alluminio

Kit for aluminium door

GC

Set completo

Kit complete

SPESSORI PORTE

SX

mm 30 ÷ 56 destro

DOOR THICKNESS

1 3/16" ÷ 2 13/64" right

L

mm 30 ÷ 56 sinistro

1 3/16" ÷ 2 13/64" left

LSX

mm 40 ÷ 70 destro

1 37/64" ÷ 2 3/4" right

mm 40 ÷ 70 sinistro

1 37/64" ÷ 2 3/4" left

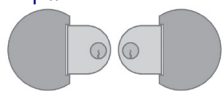

esterno
outside

interno
inside

P15 PER INGRESSO E UFFICI FOR ENTRANCES AND OFFICES

SERIE
P1

ex Pigio A10

FUNZIONE

Bloccabile o sbloccabile da entrambi i lati con chiave.

FUNCTION

Locked or unlocked from both sides by key.

P15 Pigio 15 senza scrocco senza controbordo

Pigio 15 without latch, without striking plate

FINITURE

CG Verniciato grigio chiaro
DG Verniciato grigio scuro
GF Verniciato grafite

FINISHES

Light grey coating
 Dark grey coating
 Graphite coating

VERSIONE

1 Pigio 1

VERSION

Pigio 1

FINITURE MANIGLIA

CG ABS grigio chiaro
NE ABS nero
NG Nero gommato
ABO Bianco (polimero antibatterico)

HANDLE FINISHES

ABS, light grey
 ABS, black
 Rubber finish, black
 White (antibacterial polymer)

SCROCCO

S Senza scrocco
T6 TB-60 entrata mm 60 (standard)
T7 TB-70 entrata mm 70
T8 TB-80 entrata mm 80
T127 TB-127 entrata mm 127
A6 TBA-60 antiscasso, entrata mm 60
A7 TBA-70 antiscasso, entrata mm 70
A8 TBA-80 antiscasso, entrata mm 80

TUBULAR LATCH

Without tubular latch
 TB-60 backset 2 23/64" (standard)
 TB-70 backset 2 3/4"
 TB-80 backset 3 5/32"
 TB-127 backset 5 1/64"
 TBA-60 security device, backset 2 23/64"
 TBA-70 security device, backset 2 3/4"
 TBA-80 security device, backset 3 5/32"

BORDO SCROCCO

25 Larghezza mm 22
 Larghezza mm 25

LATCH FOREND

Width 55/64"
 Width 63/64"

T Quadro
 Tondo

Square
 Round

CIFRATURE

A KD chiavi differenti
M KA chiavi uguali
G MK chiave maestra
K GMK chiave maestra generale
 GG MK chiave gran maestra generale

KEY-CHANGES

KD keyed differently
 KA keyed alike
 MK master key
 GMK general master key
 GG MK grand general master key

CONTROBORDI

C Senza controbordo
10 Art.1215 quadro
11 Art.1210 tondo
12 Art.1211 quadro
91 Art.1212 tondo
 Art.1291/R nylon nero regolabile

STRIKING PLATE

Without striking plate
 Art.1215 square
 Art.1210 round
 Art.1211 square
 Art.1212 round
 Art.1291/R adjustable, black nylon

ACCESSORI

GL Set per legno
GA Set per alluminio
GC Set completo

ACCESSORIES

Kit for wooden door
 Kit for aluminium door
 Kit complete

SPESSORI PORTE

SX mm 30 ÷ 56 destro
L mm 30 ÷ 56 sinistro
LSX mm 40 ÷ 70 destro
 mm 40 ÷ 70 sinistro

DOOR THICKNESS

1 3/16" ÷ 2 13/64" right
 1 3/16" ÷ 2 13/64" left
 1 37/64" ÷ 2 3/4" right
 1 37/64" ÷ 2 3/4" left

SERIE
P1

P17 PER AULE SCOLASTICHE E UFFICI FOR CLASSROOMS AND OFFICES

ex Pigio A05

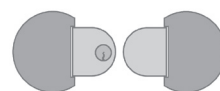

esterno
 outside

interno
 inside

FUNZIONE

Bloccabile o sbloccabile dall'esterno con chiave.
 Maniglia interna sempre azionabile.

Con funzione di tipo antipanico UNI EN 179

FUNCTION

Locked or unlocked from outside by key.
 Inside handle for free passage.

Anti-panic function UNI EN 179

P17 Pigio 17 senza scrocco senza controbordo

Pigio 17 without latch, without striking plate

CG Verniciato grigio chiaro
DG Verniciato grigio scuro
GF Verniciato grafite

FINISHES
 Light grey coating
 Dark grey coating
 Graphite coating

VERSIONE
1 Pigio 1

VERSION
 Pigio 1

FINITURE MANIGLIA
CG ABS grigio chiaro
NE ABS nero
NG Nero gommato
ABO Bianco (polimero antibatterico)

HANDLE FINISHES
 ABS, light grey
 ABS, black
 Rubber finish, black
 White (antibacterial polymer)

SCROCCO
S Senza scrocco
T6 TB-60 entrata mm 60 (standard)
T7 TB-70 entrata mm 70
T8 TB-80 entrata mm 80
T127 TB-127 entrata mm 127
A6 TBA-60 antiscasso, entrata mm 60
A7 TBA-70 antiscasso, entrata mm 70
A8 TBA-80 antiscasso, entrata mm 80

TUBULAR LATCH
 Without tubular latch
 TB-60 backset 2 23/64" (standard)
 TB-70 backset 2 3/4"
 TB-80 backset 3 5/32"
 TB-127 backset 5 1/64"
 TBA-60 security device, backset 2 23/64"
 TBA-70 security device, backset 2 3/4"
 TBA-80 security device, backset 3 5/32"

BORDO SCROCCO
25 Larghezza mm 22
 Larghezza mm 25

LATCH FOREND
 Width 55/64"
 Width 63/64"

T Quadro
 Tondo

Square
 Round

CIFRATURE
KD chiavi differenti
KA chiavi uguali
MK chiave maestra
G GMK chiave maestra generale
K GGMK chiave gran maestra generale

KEY-CHANGES
 KD keyed differently
 KA keyed alike
 MK master key
 GMK general master key
 GGMK grand general master key

CONTROBORDI
C Senza controbordo
10 Art.1215 quadro
11 Art.1210 tondo
12 Art.1211 quadro
91 Art.1212 tondo
 Art.1291/R nylon nero regolabile

STRIKING PLATE
 Without striking plate
 Art.1215 square
 Art.1210 round
 Art.1211 square
 Art.1212 round
 Art.1291/R adjustable, black nylon

ACCESSORI
GL Set per legno
GA Set per alluminio
GC Set completo

ACCESSORIES
 Kit for wooden door
 Kit for aluminium door
 Kit complete

SPESSORI PORTE
SX mm 30 ÷ 56 destro
L mm 30 ÷ 56 sinistro
LSX mm 40 ÷ 70 destro
 mm 40 ÷ 70 sinistro

DOOR THICKNESS
 1 3/16" ÷ 2 13/64" right
 1 3/16" ÷ 2 13/64" left
 1 37/64" ÷ 2 3/4" right
 1 37/64" ÷ 2 3/4" left



esterno
outside

interno
inside

P20 PER APPLICAZIONI VARIE FOR DIFFERENT APPLICATIONS

SERIE
P1

ex Pigio A70

FUNZIONE

Doppia maniglia fissa.

FUNCTION

Double fixed handle.

P20

Pigio 20

Pigio 20

CG

FINITURE CORPO

Verniciato grigio chiaro

BODY FINISHES

Light grey coating

DG

Verniciato grigio scuro

Dark grey coating

GF

Verniciato grafite

Graphite coating

VERSIONE

VERSION

1

Pigio 1

Pigio 1

CG

FINITURE MANIGLIA

ABS grigio chiaro

HANDLE FINISHES

ABS, light grey

NE

ABS nero

ABS black

NG

Nero gommato

Rubber finish, black

ABO

Bianco (polimero antibatterico)

White (antibacterial polymer)

SERIE
P1

P21 PER APPLICAZIONI VARIE FOR DIFFERENT APPLICATIONS

ex Pigio A60

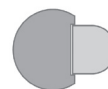

esterno
outside

FUNZIONE

Maniglia esterna fissa.
Piastra interna per fissaggio.

FUNCTION

Outside fixed handle.
Inside fixing plate.

P21

Pigio 21

Pigio 21

CG

Verniciato grigio chiaro

BODY FINISHES

Light grey coating

DG

Verniciato grigio scuro

Dark grey coating

GF

Verniciato grafite

Graphite coating

VERSIONE

1

Pigio 1

VERSION

Pigio 1

CG

ABS grigio chiaro

HANDLE FINISHES

ABS, light grey

NE

ABS nero

ABS black

NG

Nero gommato

Rubber finish, black

ABO

Bianco (polimero antibatterico)

White (antibacterial polymer)



esterno
outside

interno
inside

P24 PER CAMERE D'ALBERGO FOR HOTEL ROOMS

ex Pigio A50

SERIE
P1

FUNZIONE

Maniglia esterna senza pulsante, apertura solo con chiave.

Maniglia interna con girevole che aziona il segnalatore di occupato.

Con funzione di tipo antipanico UNI EN 179

P24

Pigio 24 senza scrocco senza controbordo

FINITURE

CG

Verniciato grigio chiaro

DG

Verniciato grigio scuro

GF

Verniciato grafite

VERSIONE

1

Pigio 1

FINITURE MANIGLIA

CG

ABS grigio chiaro

NE

ABS nero

NG

Nero gommato

ABO

Bianco (polimero antibatterico)

SCROCCO

S

Senza scrocco

T6

TB-60 entrata mm 60 (standard)

T7

TB-70 entrata mm 70

T8

TB-80 entrata mm 80

T127

TB-127 entrata mm 127

A6

TBA-60 antiscasso, entrata mm 60

A7

TBA-70 antiscasso, entrata mm 70

A8

TBA-80 antiscasso, entrata mm 80

BORDO SCROCCO

25

Larghezza mm 22

Larghezza mm 25

T

Quadro

Tondo

CIFRATURE

A

KD chiavi differenti

M

KA chiavi uguali

G

MK chiave maestra

K

GMK chiave maestra generale

GGMK chiave gran maestra generale

CONTROBORDI

C

Senza controbordo

10

Art.1215 quadro

11

Art.1210 tondo

12

Art.1211 quadro

91

Art.1212 tondo

Art.1291/R nylon nero regolabile

ACCESSORI

GL

Set per legno

G37

Set per alluminio

GC

Set completo

SPESSORI PORTE

SX

mm 30 ÷ 56 destro

L

mm 30 ÷ 56 sinistro

LSX

mm 40 ÷ 70 destro

mm 40 ÷ 70 sinistro

FUNCTION

Outside fixed handle, unlocked only by key.

Inside handle with tumblers acting on occupancy indicator.

Anti-panic function UNI EN 179

Pigio 24 without latch, without striking plate

FINISHES

Light grey coating

Dark grey coating

Graphite coating

VERSION

Pigio 1

HANDLE FINISHES

ABS, light grey

ABS, black

Rubber finish, black

White (antibacterial polymer)

TUBULAR LATCH

Without tubular latch

TB-60 backset 2 23/64" (standard)

TB-70 backset 2 3/4"

TB-80 backset 3 5/32"

TB-127 backset 5 1/64"

TBA-60 security device, backset 2 23/64"

TBA-70 security device, backset 2 3/4"

TBA-80 security device, backset 3 5/32"

LATCH FOREND

Width 55/64"

Width 63/64"

Square

Round

KEY-CHANGES

KD keyed differently

KA keyed alike

MK master key

GMK general master key

GGMK grand general master key

STRIKING PLATE

Without striking plate

Art.1215 square

Art.1210 round

Art.1211 square

Art.1212 round

Art.1291/R adjustable, black nylon

ACCESSORIES

Kit for wooden door

Kit for aluminium door

Kit complete

DOOR THICKNESS

1 3/16" ÷ 2 13/64" right

1 3/16" ÷ 2 13/64" left

1 37/64" ÷ 2 3/4" right

1 37/64" ÷ 2 3/4" left

SERIE
P1

FINITURE MANIGLIE A RICHIESTA
HANDLES FINISHING ON REQUEST

Per serratura

For lock

AP
VE

ABS amaranto
ABS verde scuro

ABS, amaranth
ABS, dark green

i

Quantità minima per ordine 50 pz

Minimum order quantity 50 pcs



pigio 2

info e preventivi
<http://www.bellittiserrature.it/contact.asp>

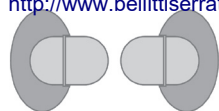

esterno
outside

interno
inside

P11 PER LOCALI DI PASSAGGIO FOR PASSAGEWAYS

ex Pigio B00

SERIE
P2

FUNZIONE

Entrambe le maniglie sempre azionabili.

FUNCTION

Outside and inside handles for free passage.

P11 Pigio 11 senza scrocco senza controbordo

Pigio 11 without latch, without striking plate

FINITURE

CG Verniciato grigio chiaro

FINISHES
Light grey coating

DG Verniciato grigio scuro

Dark grey coating

6D Verniciato cromo opaco (US26D)

Matt chrome coating (US26D)

VERSIONE

2 Pigio 2

VERSION

Pigio 2

FINITURE MANIGLIA

CG ABS grigio chiaro

HANDLE FINISHES

ABS, light grey

DG ABS grigio scuro

ABS, dark grey

BO ABS bianco

ABS, white

NG Nero gommato

Rubber finish, black

SCROCCO

S Senza scrocco

TUBULAR LATCH

Without tubular latch

T6 TB-60 entrata mm 60 (standard)

TB-60 backset 2 23/64" (standard)

T7 TB-70 entrata mm 70

TB-70 backset 2 3/4"

T8 TB-80 entrata mm 80

TB-80 backset 3 5/32"

T127 TB-127 entrata mm 127

TB-127 backset 5 1/64"

A6 TBA-60 antiscasso, entrata mm 60

TBA-60 security device, backset 2 23/64"

A7 TBA-70 antiscasso, entrata mm 70

TBA-70 security device, backset 2 3/4"

A8 TBA-80 antiscasso, entrata mm 80

TBA-80 security device, backset 3 5/32"

BORDO SCROCCO

25 Larghezza mm 22

LATCH FOREND

Width 55/64"

Larghezza mm 25

Width 63/64"

T Quadro

Square

Tondo

Round

CONTROBORDI

C Senza controbordo

STRIKING PLATE

Without striking plate

Art.1215 quadro

Art.1215 square

10 Art.1210 tondo

Art.1210 round

11 Art.1211 quadro

Art.1211 square

12 Art.1212 tondo

Art.1212 round

91 Art.1291/R nylon nero regolabile

Art.1291/R adjustable, black nylon

ACCESSORI

GL Set per legno

ACCESSORIES

Kit for wooden door

GA Set per alluminio

Kit for aluminium door

GC Set completo

Kit complete

SPESSORI PORTE

L mm 30 ÷ 56 destro

DOOR THICKNESS

1 3/16" ÷ 2 13/64" right

mm 40 ÷ 70 destro

1 37/64" ÷ 2 3/4" right

SERIE
P2

P12 PER BAGNI FOR BATHROOMS

ex Pigio B30

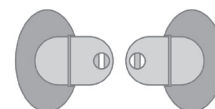

esterno
 outside

interno
 inside

FUNZIONE

Apertura esterna con moneta, cacciavite, o qualsiasi attrezzo simile.

Maniglia interna con girevole che aziona il segnalatore di occupato se utilizzato.

FUNCTION

Unlocked from outside by coin, screwdriver, or any other similar tool.

Inside handle with thumbturn acting on occupancy indicator if provided.

P12

Pigio 12 senza scrocco senza controbordo

Pigio 12 without latch, without striking plate

FINITURE

CG

Verniciato grigio chiaro

FINISHES

Light grey coating

DG

Verniciato grigio scuro

Dark grey coating

6D

Verniciato cromo opaco (US26D)

Matt chrome coating (US26D)

VERSIONE

2

Pigio 2

VERSION

Pigio 2

FINITURE MANIGLIA

CG

ABS grigio chiaro

HANDLE FINISHES

ABS, light grey

DG

ABS grigio scuro

ABS, dark grey

BO

ABS bianco

ABS, white

NG

Nero gommatto

Rubber finish, black

SCROCCO

S

Senza scrocco

TUBULAR LATCH

Without tubular latch

T6

TB-60 entrata mm 60 (standard)

TB-60 backset 2 23/64" (standard)

T7

TB-70 entrata mm 70

TB-70 backset 2 3/4"

T8

TB-80 entrata mm 80

TB-80 backset 3 5/32"

T127

TB-127 entrata mm 127

TB-127 backset 5 1/64"

A6

TBA-60 antiscasso, entrata mm 60

TBA-60 security device, backset 2 23/64"

A7

TBA-70 antiscasso, entrata mm 70

TBA-70 security device, backset 2 3/4"

A8

TBA-80 antiscasso, entrata mm 80

TBA-80 security device, backset 3 5/32"

BORDO SCROCCO

25

Larghezza mm 22

Larghezza mm 25

LATCH FOREND

Width 55/64"

Width 63/64"

Quadro

Square

T

Tondo

Round

CONTROBORDI

C

Senza controbordo

STRIKING PLATE

Without striking plate

10

Art.1215 quadro

Art.1215 square

11

Art.1210 tondo

Art.1210 round

11

Art.1211 quadro

Art.1211 square

12

Art.1212 tondo

Art.1212 round

91

Art.1291/R nylon nero regolabile

Art.1291/R adjustable, black nylon

ACCESSORI

GL

Set per legno

ACCESSORIES

Kit for wooden door

GA

Set per alluminio

Kit for aluminium door

GC

Set completo

Kit complete

SPESSORI PORTE

L

mm 30 ÷ 56 destro

DOOR THICKNESS

1 3/16" ÷ 2 13/64" right

mm 40 ÷ 70 destro

1 37/64" ÷ 2 3/4" right



esterno
outside

interno
inside

P12E PER BAGNI FOR BATHROOMS

ex Pigio B37

SERIE
P2

FUNZIONE

Apertura esterna con moneta, cacciavite, o qualsiasi attrezzo simile.

Maniglia interna con girevole che aziona il segnalatore occupato

Con funzione di tipo antipanico UNI EN 179

FUNCTION

Unlocked from outside by coin, screwdriver or any other similar tool.

Inside handle with thumbturn acting on occupancy indicator

Anti-panic function UNI EN 179

Pigio 12/E without latch, without striking plate

Pigio 12/E senza scrocco senza controbordo

FINITURE

Verniciato grigio chiaro

Verniciato grigio scuro

Verniciato cromo opaco (US26D)

FINISHES

Light grey coating

Dark grey coating

Matt chrome coating (US26D)

VERSIONE

Pigio 2

VERSION

Pigio 2

FINITURE MANIGLIA

ABS grigio chiaro

ABS grigio scuro

ABS bianco

Nero gommato

HANDLE FINISHES

ABS, light grey

ABS, dark grey

ABS, white

Rubber finish, black

SCROCCO

Senza scrocco

TB-60 entrata mm 60 (standard)

TB-70 entrata mm 70

TB-80 entrata mm 80

TB-127 entrata mm 127

TBA-60 antiscasso, entrata mm 60

TBA-70 antiscasso, entrata mm 70

TBA-80 antiscasso, entrata mm 80

TUBULAR LATCH

Without tubular latch

TB-60 backset 2 23/64" (standard)

TB-70 backset 2 3/4"

TB-80 backset 3 5/32"

TB-127 backset 5 1/64"

TBA-60 security device, backset 2 23/64"

TBA-70 security device, backset 2 3/4"

TBA-80 security device, backset 3 5/32"

BORDO SCROCCO

Larghezza mm 22

Larghezza mm 25

LATCH FOREND

Width 55/64"

Width 63/64"

Quadro

Square

Tondo

Round

CONTROBORDI

Senza controbordo

Art.1215 quadro

Art.1210 tondo

Art.1211 quadro

Art.1212 tondo

Art.1291/R nylon nero regolabile

STRIKING PLATE

Without striking plate

Art.1215 square

Art.1210 round

Art.1211 square

Art.1212 round

Art.1291/R adjustable, black nylon

ACCESSORI

Set per legno

Set per alluminio

Set completo

ACCESSORIES

Kit for wooden door

Kit for aluminium door

Kit complete

SPessori PORTE

mm 30 ÷ 56 destro

mm 40 ÷ 70 destro

DOOR THICKNESS

1 3/16" ÷ 2 13/64" right

1 37/64" ÷ 2 3/4" right

SERIE
P2

P13 PER INGRESSO E UFFICI FOR ENTRANCES AND OFFICES

ex Pigio B20

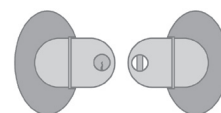

esterno
 outside

interno
 inside

FUNZIONE

Bloccabile o sbloccabile dall'esterno con chiave.
 Maniglia interna con girevole..

FUNCTION

Locked or unlocked from outside by key.
 Inside handle with thumbturn.

P13

Pigio 13 senza scrocco senza controbordo

Pigio 13 without latch, without striking plate

CG

Verniciato grigio chiaro

FINISHES

Light grey coating

DG

Verniciato grigio scuro

Dark grey coating

6D

Verniciato cromo opaco (US26D)

Matt chrome coating (US26D)

VERSIONE

Pigio 2

VERSION

Pigio 2

2

FINITURE MANIGLIA

CG

ABS grigio chiaro

HANDLE FINISHES

ABS, light grey

DG

ABS grigio scuro

ABS, dark grey

BO

ABS bianco

ABS, white

NG

Nero gommato

Rubber finish, black

SCROCCO

Senza scrocco

TUBULAR LATCH

Without tubular latch

S

T6

TB-60 entrata mm 60 (standard)

TB-60 backset 2 23/64" (standard)

T7

TB-70 entrata mm 70

TB-70 backset 2 3/4"

T8

TB-80 entrata mm 80

TB-80 backset 3 5/32"

T127

TB-127 entrata mm 127

TB-127 backset 127 mm

A6

TBA-60 antiscasso, entrata mm 60

TBA-60 security device, backset 2 23/64"

A7

TBA-70 antiscasso, entrata mm 70

TBA-70 security device, backset 2 3/4"

A8

TBA-80 antiscasso, entrata mm 80

TBA-80 security device, backset 3 5/32"

BORDO SCROCCO

Larghezza mm 22

LATCH FOREND

Width 55/64"

25

Larghezza mm 25

Width 63/64"

Quadro

Square

T

Tondo

Round

CIFRATURE

KD chiavi differenti

KEY-CHANGES

KD keyed differently

KA chiavi uguali

KA keyed alike

A

MK chiave maestra

MK master key

M

GMK chiave maestra generale

GMK general master key

G

GGMK chiave gran maestra generale

GGMK grand general master key

K

CONTROBORDI

Senza controbordo

STRIKING PLATE

Without striking plate

C

Art.1215 quadro

Art.1215 square

10

Art.1210 tondo

Art.1210 round

11

Art.1211 quadro

Art.1211 square

12

Art.1212 tondo

Art.1212 round

91

Art.1291/R nylon nero regolabile

Art.1291/R adjustable, black nylon

ACCESSORI

Set per legno

ACCESSORIES

Kit for wooden door

GL

Set per alluminio

Kit for aluminium door

GA

GC

Set completo

Kit complete

SPESSORI PORTE

mm 30 ÷ 56 destro

DOOR THICKNESS

1 3/16" ÷ 2 13/64" right

SX

mm 30 ÷ 56 sinistro

1 3/16" ÷ 2 13/64" left

L

mm 40 ÷ 70 destro

1 37/64" ÷ 2 3/4" right

LSX

mm 40 ÷ 70 sinistro

1 37/64" ÷ 2 3/4" left

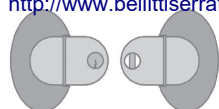

esterno
outside

interno
inside

P13E PER INGRESSO E UFFICI FOR ENTRANCES AND OFFICES

ex Pigio B25

SERIE
P2

FUNZIONE

Bloccabile o sbloccabile dall'esterno con chiave.
 Maniglia interna con girevole.

Con funzione di tipo antipanico UNI EN 179

FUNCTION

Locked or unlocked from outside by key.
 Inside handle with thumbturn.

Anti-panic function UNI EN 179

P13E

Pigio 13/E senza scrocco senza controbordo

Pigio 13/E without latch, without striking plate

CG

Verniciato grigio chiaro

FINISHES

Light grey coating

DG

Verniciato grigio scuro

Dark grey coating

6D

Verniciato cromo opaco (US26D)

Matt chrome coating (US26D)

VERSIONE

Pigio 2

VERSION

Pigio 2

2

FINITURE MANIGLIA

CG

ABS grigio chiaro

HANDLE FINISHES

ABS, light grey

DG

ABS grigio scuro

ABS, dark grey

BO

ABS bianco

ABS, white

NG

Nero gommato

Rubber finish, black

SCROCCO

Senza scrocco

TUBULAR LATCH

Without tubular latch

S

T6

TB-60 entrata mm 60 (standard)

TB-60 backset 2 23/64" (standard)

T7

TB-70 entrata mm 70

TB-70 backset 2 3/4"

T8

TB-80 entrata mm 80

TB-80 backset 3 5/32"

T127

TB-127 entrata mm 127

TB-127 backset 127 mm

A6

TBA-60 antiscasso, entrata mm 60

TBA-60 security device, backset 2 23/64"

A7

TBA-70 antiscasso, entrata mm 70

TBA-70 security device, backset 2 3/4"

A8

TBA-80 antiscasso, entrata mm 80

TBA-80 security device, backset 3 5/32"

BORDO SCROCCO

Larghezza mm 22

LATCH FOREND

Width 55/64"

25

Larghezza mm 25

Width 63/64"

Quadro

Square

T

Tondo

Round

CIFRATURE

KD chiavi differenti

KEY-CHANGES

KD keyed differently

KA chiavi uguali

KA keyed alike

MK chiave maestra

MK master key

GMK chiave maestra generale

GMK general master key

GGMK chiave gran maestra generale

GGMK grand general master key

CONTROBORDI

Senza controbordo

STRIKING PLATE

Without striking plate

C

Art.1215 quadro

Art.1215 square

10

Art.1210 tondo

Art.1210 round

11

Art.1211 quadro

Art.1211 square

12

Art.1212 tondo

Art.1212 round

91

Art.1291/R nylon nero regolabile

Art.1291/R adjustable, black nylon

ACCESSORI

Set per legno

ACCESSORIES

Kit for wooden door

GL

Set per alluminio

Kit for aluminium door

GA

GC

Set completo

Kit complete

SPESSORI PORTE

mm 30 ÷ 56 destro

DOOR THICKNESS

1 3/16" ÷ 2 13/64" right

SX

mm 30 ÷ 56 sinistro

1 3/16" ÷ 2 13/64" left

L

mm 40 ÷ 70 destro

1 37/64" ÷ 2 3/4" right

LSX

mm 40 ÷ 70 sinistro

1 37/64" ÷ 2 3/4" left

SERIE
P2

P14 PER CAMERE D'ALBERGO FOR HOTEL ROOMS

ex Pigio B40

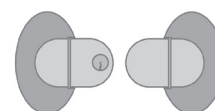

esterno
 outside

interno
 inside

FUNZIONE

Maniglia esterna sempre fissa, sbloccabile solo dall'esterno con chiave.

Maniglia interna sempre azionabile.

Con funzione di tipo antipanico UNI EN 179

FUNCTION

Fixed outside handle, unlocked only from outside by key.

Inside handle for free passage.

Anti-panic function UNI EN 179

P14 Pigio 14 senza scrocco senza controbordo

Pigio 14 without latch, without striking plate

FINITURE

CG	Verniciato grigio chiaro
DG	Verniciato grigio scuro
6D	Verniciato cromo opaco (US26D)

FINISHES

Light grey coating
Dark grey coating
Matt chrome coating (US26D)

VERSIONE

2 Pigio 2

VERSION

Pigio 2

FINITURE MANIGLIA

CG	ABS grigio chiaro
DG	ABS grigio scuro
BO	ABS bianco
NG	Nero gommato

HANDLE FINISHES

ABS, light grey
ABS, dark grey
ABS, white
Rubber finish, black

SCROCCO

S	Senza scrocco
T6	TB-60 entrata mm 60 (standard)
T7	TB-70 entrata mm 70
T8	TB-80 entrata mm 80
T127	TB-127 entrata mm 127
A6	TBA-60 antiscasso, entrata mm 60
A7	TBA-70 antiscasso, entrata mm 70
A8	TBA-80 antiscasso, entrata mm 80

TUBULAR LATCH

Without tubular latch
TB-60 backset 2 23/64" (standard)
TB-70 backset 2 3/4"
TB-80 backset 3 5/32"
TB-127 backset 127 mm
TBA-60 security device, backset 2 23/64"
TBA-70 security device, backset 2 3/4"
TBA-80 security device, backset 3 5/32"

BORDO SCROCCO

25	Larghezza mm 22
	Larghezza mm 25

LATCH FOREND

Width 55/64"
Width 63/64"

Quadro

Square

Tondo

Round

CIFRATURE

A	KD chiavi differenti
M	KA chiavi uguali
G	MK chiave maestra
K	GMK chiave maestra generale
	GGMK chiave gran maestra generale

KEY-CHANGES

KD	keyed differently
KA	keyed alike
MK	master key
GMK	general master key
GGMK	grand general master key

CONTROBORDI

C	Senza controbordo
10	Art.1215 quadro
11	Art.1210 tondo
12	Art.1211 quadro
91	Art.1212 tondo
	Art.1291/R nylon nero regolabile

STRIKING PLATE

Without striking plate
Art.1215 square
Art.1210 round
Art.1211 square
Art.1212 round
Art.1291/R adjustable, black nylon

ACCESSORI

GL	Set per legno
GA	Set per alluminio
GC	Set completo

ACCESSORIES

Kit for wooden door
Kit for aluminium door
Kit complete

SPESSORI PORTE

SX	mm 30 ÷ 56 destro
L	mm 30 ÷ 56 sinistro
LSX	mm 40 ÷ 70 destro
	mm 40 ÷ 70 sinistro

DOOR THICKNESS

1 3/16" ÷ 2 13/64" right
1 3/16" ÷ 2 13/64" left
1 37/64" ÷ 2 3/4" right
1 37/64" ÷ 2 3/4" left

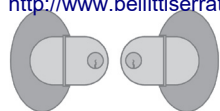

esterno
outside

interno
inside

P15 PER INGRESSO E UFFICI FOR ENTRANCES AND OFFICES

ex Pigio B10

SERIE
P2

FUNZIONE

Bloccabile o sbloccabile da entrambi i lati con chiave.

FUNCTION

Locked or unlocked from both sides by key.

P15 Pigio 15 senza scrocco senza controbordo

Pigio 15 without latch, without striking plate

FINITURE

CG Verniciato grigio chiaro
DG Verniciato grigio scuro
6D Verniciato cromo opaco (US26D)

FINISHES

Light grey coating
 Dark grey coating
 Matt chrome coating (US26D)

VERSIONE

2 Pigio 2

VERSION

Pigio 2

FINITURE MANIGLIA

CG ABS grigio chiaro
DG ABS grigio scuro
BO ABS bianco
NG Nero gommatato

HANDLE FINISHES

ABS, light grey
 ABS, dark grey
 ABS, white
 Rubber finish, black

SCROCCO

S Senza scrocco
T6 TB-60 entrata mm 60 (standard)
T7 TB-70 entrata mm 70
T8 TB-80 entrata mm 80
T127 TB-127 entrata mm 127
A6 TBA-60 antiscasso, entrata mm 60
A7 TBA-70 antiscasso, entrata mm 70
A8 TBA-80 antiscasso, entrata mm 80

TUBULAR LATCH

Without tubular latch
 TB-60 backset 2 23/64" (standard)
 TB-70 backset 2 3/4"
 TB-80 backset 3 5/32"
 TB-127 backset 127 mm
 TBA-60 security device, backset 2 23/64"
 TBA-70 security device, backset 2 3/4"
 TBA-80 security device, backset 3 5/32"

BORDO SCROCCO

25 Larghezza mm 22
 Larghezza mm 25

LATCH FOREND

Width 55/64"
 Width 63/64"

T Quadro
 Tondo

Square
 Round

CIFRATURE

A KD chiavi differenti
M KA chiavi uguali
G MK chiave maestra
K GMK chiave maestra generale
 GGMK chiave gran maestra generale

KEY-CHANGES

KD keyed differently
 KA keyed alike
 MK master key
 GMK general master key
 GGMK grand general master key

CONTROBORDI

C Senza controbordo
10 Art.1215 quadro
11 Art.1210 tondo
12 Art.1211 quadro
91 Art.1212 tondo
 Art.1291/R nylon nero regolabile

STRIKING PLATE

Without striking plate
 Art.1215 square
 Art.1210 round
 Art.1211 square
 Art.1212 round
 Art.1291/R adjustable, black nylon

ACCESSORI

GL Set per legno
GA Set per alluminio
GC Set completo

ACCESSORIES

Kit for wooden door
 Kit for aluminium door
 Kit complete

SPESSORI PORTE

SX mm 30 ÷ 56 destro
L mm 30 ÷ 56 sinistro
LSX mm 40 ÷ 70 destro
 mm 40 ÷ 70 sinistro

DOOR THICKNESS

1 3/16" ÷ 2 13/64" right
 1 3/16" ÷ 2 13/64" left
 1 37/64" ÷ 2 3/4" right
 1 37/64" ÷ 2 3/4" left

SERIE
P2

P17 PER AULE SCOLASTICHE E UFFICI FOR CLASSROOMS AND OFFICES

ex Pigio B05

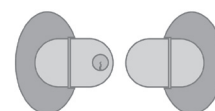

esterno
 outside

interno
 inside

FUNZIONE

Bloccabile o sbloccabile dall'esterno con chiave.
 Maniglia interna sempre azionabile.

Con funzione di tipo antipanico UNI EN 179

FUNCTION

Locked or unlocked from outside by key.
 Inside handle for free passage.

Anti-panic function UNI EN 179

P17

Pigio 17 senza scrocco senza controbordo

Pigio 17 without tubular latch and striking plate

FINITURE

CG

Verniciato grigio chiaro

FINISHES

Light grey coating

DG

Verniciato grigio scuro

Dark grey coating

6D

Verniciato cromo opaco (US26D)

Matt chrome coating (US26D)

VERSIONE

2

Pigio 2

VERSION

Pigio 2

FINITURE MANIGLIA

CG

ABS grigio chiaro

HANDLE FINISHES

ABS, light grey

DG

ABS grigio scuro

ABS, dark grey

BO

ABS bianco

ABS, white

NG

Nero gommatato

Rubber finish, black

SCROCCO

S

Senza scrocco

TUBULAR LATCH

Without tubular latch

T6

TB-60 entrata mm 60 (standard)

TB-60 backset 2 23/64" (standard)

T7

TB-70 entrata mm 70

TB-70 backset 2 3/4"

T8

TB-80 entrata mm 80

TB-80 backset 3 5/32"

T127

TB-127 entrata mm 127

TB-127 backset 127 mm

A6

TBA-60 antiscasso, entrata mm 60

TBA-60 security device, backset 2 23/64"

A7

TBA-70 antiscasso, entrata mm 70

TBA-70 security device, backset 2 3/4"

A8

TBA-80 antiscasso, entrata mm 80

TBA-80 security device, backset 3 5/32"

BORDO SCROCCO

25

Larghezza mm 22

LATCH FOREND

Width 55/64"

Larghezza mm 25

Width 63/64"

Quadro

Square

T

Tondo

Round

CIFRATURE

A

KD chiavi differenti

KEY-CHANGES

KD keyed differently

M

KA chiavi uguali

KA keyed alike

G

MK chiave maestra

MK master key

K

GMK chiave maestra generale

GMK general master key

GGMK chiave gran maestra generale

GGMK grand general master key

CONTROBORDI

C

Senza controbordo

STRIKING PLATE

Without striking plate

10

Art.1215 quadro

Art.1215 square

11

Art.1210 tondo

Art.1210 round

12

Art.1211 quadro

Art.1211 square

91

Art.1212 tondo

Art.1212 round

Art.1291/R nylon nero regolabile

Art.1291/R adjustable, black nylon

ACCESSORI

GL

Set per legno

ACCESSORIES

Kit for wooden door

GA

Set per alluminio

Kit for aluminium door

GC

Set completo

Kit complete

SPESSORI PORTE

SX

mm 30 ÷ 56 destro

DOOR THICKNESS

1 3/16" ÷ 2 13/64" right

L

mm 30 ÷ 56 sinistro

1 3/16" ÷ 2 13/64" left

LSX

mm 40 ÷ 70 destro

1 37/64" ÷ 2 3/4" right

mm 40 ÷ 70 sinistro

1 37/64" ÷ 2 3/4" left

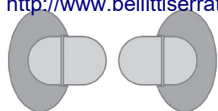

esterno
outside

interno
inside

P20 PER APPLICAZIONI VARIE FOR DIFFERENT APPLICATIONS

SERIE
P2

ex Pigio B70

FUNZIONE

Doppia maniglia fissa.

FUNCTION

Double fixed handle.

P20

Pigio 20

Pigio 20

CG

Verniciato grigio chiaro

BODY FINISHES

Light grey coating

DG

Verniciato grigio scuro

Dark grey coating

6D

Verniciato cromo opaco

Matt chrome coating

VERSIONE

VERSION

2

Pigio 2

Pigio 2

BO

ABS bianco

HANDLE FINISHES

ABS, white

CG

ABS grigio chiaro

ABS, light grey

DG

ABS grigio scuro

ABS, dark grey

NG

Nero gommato

Rubber finish, black

SERIE
P21

P21 PER APPLICAZIONI VARIE FOR DIFFERENT APPLICATIONS

ex Pigio B60



esterno
outside

FUNZIONE

Maniglia esterna fissa.
Piastra interna per fissaggio.

FUNCTION

Outside fixed handle.
Inside fixing plate.

P21

Pigio 21

Pigio 21

CG

Verniciato grigio chiaro

BODY FINISHES

Light grey coating

DG

Verniciato grigio scuro

Dark grey coating

6D

Verniciato cromo opaco

Matt chrome coating

VERSIONE

VERSION

2

Pigio 2

Pigio 2

BO

ABS bianco

HANDLE FINISHES

ABS, white

CG

ABS grigio chiaro

ABS, light grey

DG

ABS grigio scuro

ABS, dark grey

NG

Nero gommato

Rubber finish, black



esterno
outside

interno
inside

P24 PER CAMERE D'ALBERGO FOR HOTEL ROOMS

**SERIE
P2**

ex Pigio B50

FUNZIONE

Maniglia esterna senza pulsante, apertura solo con chiave.

Maniglia interna con girevole che aziona il segnalatore di occupato.

Con funzione di tipo antipanico UNI EN 179

P24

Pigio 24 senza scrocco senza controbordo

FINITURE

CG

Verniciato grigio chiaro

DG

Verniciato grigio scuro

6D

Verniciato cromo opaco (US26D)

VERSIONE

2

Pigio 2

FINITURE MANIGLIA

CG

ABS grigio chiaro

DG

ABS grigio scuro

BO

ABS bianco

NG

Nero gommato

SCROCCO

S

Senza scrocco

T6

TB-60 entrata mm 60 (standard)

T7

TB-70 entrata mm 70

T8

TB-80 entrata mm 80

T127

TB-127 entrata mm 127

A6

TBA-60 antiscasso, entrata mm 60

A7

TBA-70 antiscasso, entrata mm 70

A8

TBA-80 antiscasso, entrata mm 80

BORDO SCROCCO

25

Larghezza mm 22

Larghezza mm 25

T

Quadro

Tondo

CIFRATURE

A

KD chiavi differenti

M

KA chiavi uguali

G

MK chiave maestra

K

GMK chiave maestra generale

GGMK chiave gran maestra generale

CONTROBORDI

C

Senza controbordo

10

Art.1215 quadro

11

Art.1210 tondo

12

Art.1211 quadro

91

Art.1212 tondo

Art.1291/R nylon nero regolabile

ACCESSORI

GL

Set per legno

G37

Set per alluminio

GC

Set completo

SPESSORI PORTE

SX

mm 30 ÷ 56 destro

L

mm 30 ÷ 56 sinistro

LSX

mm 40 ÷ 70 destro

mm 40 ÷ 70 sinistro

FUNCTION

Outside fixed handle, unlocked only by key.

Inside handle with tumbturn acting on occupancy indicator.

Anti-panic function UNI EN 179

Pigio 24 without latch, without striking plate

FINISHES

Light grey coating

Dark grey coating

Matt chrome coating (US26D)

VERSION

Pigio 2

HANDLE FINISHES

ABS, light grey

ABS, dark grey

ABS, white

Rubber finish, black

TUBULAR LATCH

Without tubular latch

TB-60 backset 2 23/64" (standard)

TB-70 backset 2 3/4"

TB-80 backset 3 5/32"

TB-127 backset 127 mm

TBA-60 security device, backset 2 23/64"

TBA-70 security device, backset 2 3/4"

TBA-80 security device, backset 3 5/32"

LATCH FOREND

Width 55/64"

Width 63/64"

Square

Round

KEY-CHANGES

KD keyed differently

KA keyed alike

MK master key

GMK general master key

GGMK grand general master key

STRIKING PLATE

Without striking plate

Art.1215 square

Art.1210 round

Art.1211 square

Art.1212 round

Art.1291/R adjustable, black nylon

ACCESSORIES

Kit for wooden door

Kit for aluminium door

Kit complete

DOOR THICKNESS

1 3/16" ÷ 2 13/64" right

1 3/16" ÷ 2 13/64" left

1 37/64" ÷ 2 3/4" right

1 37/64" ÷ 2 3/4" left

SERIE
P2

FINITURE MANIGLIE A RICHIESTA
HANDLES FINISHING ON REQUEST

Per serratura

For lock

AV	Aragosta pastello	Lobster red
AZ	Azzurro pastello	Light blue
BP	Bianco perla	Pearl white
BV	Blu pastello	Blue
LB	Blu gommato	Rubber finish, blue
LR	Rosso gommato	Rubber finish, red
VA	Verde acido	Acid green
VP	Verde perla	Pearl green
VV	Verde pastello	Green

i

Quantità minima per ordine 50 pz

Minimum order quantity 50 pcs



pigio 3

info e preventivi
<http://www.bellittiserrature.it/contact.asp>

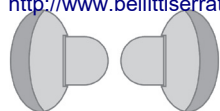

esterno
outside

interno
inside

P11 PER LOCALI DI PASSAGGIO FOR PASSAGEWAYS

ex Pigio C00

SERIE
P3

FUNZIONE

Entrambe le maniglie sempre azionabili.

FUNCTION

Outside and inside handles for free passage.

P11 Pigio 11 senza scrocco senza controbordo

Pigio 11 without latch, without striking plate

FINITURE

6D Verniciato cromo opaco (US26D)

FINISHES

Matt chrome coating (US26D)

VERSIONE

3 Pigio 3

VERSION

Pigio 3

FINITURE MANIGLIA

G4 Grigio gommato

NG Nero gommato

AM Amaranto metallizzato

HANDLE FINISHES

Rubber finish, grey

Rubber finish, black

Metalized amaranth coating

SCROCCO

S Senza scrocco

T6 TB-60 mm 60 (standard)

T7 TB-70 mm 70

T8 TB-80 mm 80

T127 TB-127 mm 127

A6 TBA-60 antiscasso, entrata mm 60

A7 TBA-70 antiscasso, entrata mm 70

A8 TBA-80 antiscasso, entrata mm 80

TUBULAR LATCH

Without tubular latch

TB-60 backset 2 23/64" (standard)

TB-70 backset 2 3/4"

TB-80 backset 3 5/32"

TB-127 backset 5 1/64"

TBA-60 security device, backset 2 23/64"

TBA-70 security device, backset 2 3/4"

TBA-80 security device, backset 3 5/32"

BORDO SCROCCO

Larghezza mm 22

25 Larghezza mm 25

LATCH FOREND

Width 55/64"

Width 63/64"

Quadro

T Tondo

Square

Round

CONTROBORDI

Senza controbordo

Art.1215 quadro

Art.1210 tondo

Art.1211 quadro

Art.1212 tondo

Art.1291/R nylon nero regolabile

STRIKING PLATE

Without striking plate

Art.1215 square

Art.1210 round

Art.1211 square

Art.1212 round

Art.1291/R adjustable, black nylon

ACCESSORI

GL Set per legno

GA Set per alluminio

GC Set completo

ACCESSORIES

Kit for wooden door

Kit for aluminium door

Kit complete

SPessori PORTE

mm 30 ÷ 56 destro

L mm 40 ÷ 70 destro

DOOR THICKNESS

1 3/16" ÷ 2 13/64" right

1 37/64" ÷ 2 3/4" right

SERIE
P3

P12 PER BAGNI FOR BATHROOMS

ex Pigio C30

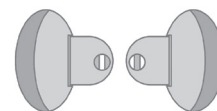

esterno
outside

interno
inside

FUNZIONE

Apertura esterna con moneta, cacciavite, o qualsiasi attrezzo simile.

Maniglia interna con girevole che aziona il segnalatore di occupato se utilizzato.

FUNCTION

Unlocked from outside by coin, screwdriver, or any other similar tool.

Inside handle with thumbturn acting on occupancy indicator if provided.

P12

Pigio 12 senza scrocco senza controbordo

Pigio 12 without latch, without striking plate

FINITURE

6D

Verniciato cromo opaco (US26D)

FINISHES

Matte chrome coating (US26D)

VERSIONE

3

Pigio 3

VERSION

Pigio 3

FINITURE MANIGLIA

G4

Grigio gommato

NG

Nero gommato

AM

Amaranto metallizzato

HANDLE FINISHES

Rubber finish, grey

Rubber finish, black

Metalized amaranth coating

SCROCCO

S

Senza scrocco

T6

TB-60 mm 60 (standard)

T7

TB-70 mm 70

T8

TB-80 mm 80

T127

TB-127 mm 127

A6

TBA-60 antiscasso, entrata mm 60

A7

TBA-70 antiscasso, entrata mm 70

A8

TBA-80 antiscasso, entrata mm 80

TUBULAR LATCH

Without tubular latch

TB-60 backset 2 23/64" (standard)

TB-70 backset 2 3/4"

TB-80 backset 3 5/32"

TB-127 backset 5 1/64"

TBA-60 security device, backset 2 23/64"

TBA-70 security device, backset 2 3/4"

TBA-80 security device, backset 3 5/32"

BORDO SCROCCO

25

Larghezza mm 22

Larghezza mm 25

LATCH FOREND

Width 55/64"

Width 63/64"

Quadro

T

Tondo

Square

Round

CONTROBORDI

C

Senza controbordo

10

Art.1215 quadro

11

Art.1210 tondo

12

Art.1211 quadro

91

Art.1212 tondo

Art.1291/R nylon nero regolabile

STRIKING PLATE

Without striking plate

Art.1215 square

Art.1210 round

Art.1211 square

Art.1212 round

Art.1291/R adjustable, black nylon

ACCESSORI

GL

Set per legno

GA

Set per alluminio

GC

Set completo

ACCESSORIES

Kit for wooden door

Kit for aluminium door

Kit complete

SPessori PORTE

L

mm 30 ÷ 56 destro

mm 40 ÷ 70 destro

DOOR THICKNESS

1 3/16" ÷ 2 13/64" right

1 37/64" ÷ 2 3/4" right

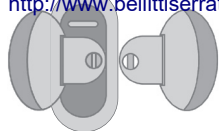

esterno
outside

interno
inside

P12E PER BAGNI FOR BATHROOMS

ex Pigio C37

SERIE
P3

FUNZIONE

Apertura esterna con moneta, cacciavite, o qualsiasi attrezzo simile.

Maniglia interna con girevole che aziona il segnalatore occupato

Con funzione di tipo antipanico UNI EN 179

FUNCTION

Unlocked from outside by coin, screwdriver or any other similar tool.

Inside handle with thumbturn acting on occupancy indicator

Anti-panic function UNI EN 179

P12E

Pigio 12/E senza scrocco senza controbordo

Pigio 12/E without latch, without striking plate

6D

FINITURE

Verniciato cromo opaco (US26D)

FINISHES

Matt chrome coating (US26D)

3

VERSIONE

Pigio 3

VERSION

Pigio 3

G4

FINITURE MANIGLIA

Grigio gommato

NG

Nero gommato

AM

Amaranto metallizzato

HANDLE FINISHES

Rubber finish, grey

Rubber finish, black

Metalized amaranth coating

S

SCROCCO

Senza scrocco

TUBULAR LATCH

Without tubular latch

T6

TB-60 mm 60 (standard)

TB-60 backset 2 23/64" (standard)

T7

TB-70 mm 70

TB-70 backset 2 3/4"

T8

TB-80 mm 80

TB-80 backset 3 5/32"

T127

TB-127 mm 127

TB-127 backset 5 1/64"

A6

TBA-60 antiscasso, entrata mm 60

TBA-60 security device, backset 2 23/64"

A7

TBA-70 antiscasso, entrata mm 70

TBA-70 security device, backset 2 3/4"

A8

TBA-80 antiscasso, entrata mm 80

TBA-80 security device, backset 3 5/32"

25

BORDO SCROCCO

Larghezza mm 22

Larghezza mm 25

LATCH FOREND

Width 55/64"

Width 63/64"

T

Quadro

Tondo

Square

Round

C

CONTROBORDI

Senza controbordo

STRIKING PLATE

Without striking plate

Art.1215 quadro

Art.1215 square

Art.1210 tondo

Art.1210 round

Art.1211 quadro

Art.1211 square

Art.1212 tondo

Art.1212 round

Art.1291/R nylon nero regolabile

Art.1291/R adjustable, black nylon

GL

ACCESSORI

Set per legno

ACCESSORIES

Kit for wooden door

G37

Set per alluminio

Kit for aluminium door

GC

Set completo

Kit complete

L

SPESSORI PORTE

mm 30 ÷ 56 destro

mm 40 ÷ 70 destro

DOOR THICKNESS

1 3/16" ÷ 2 13/64" right

1 37/64" ÷ 2 3/4" right

SERIE
P3

P13 PER INGRESSO E UFFICI FOR ENTRANCES AND OFFICES

ex Pigio C20

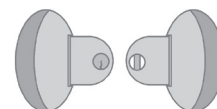

esterno
 outside

interno
 inside

FUNZIONE

Bloccabile o sbloccabile dall'esterno con chiave.
 Maniglia interna con girevole.

FUNCTION

Locked or unlocked from outside by key.
 Inside handle with thumbturn.

P13

Pigio 13 senza scrocco senza controbordo

Pigio 13 without latch, without striking plate

6D

FINITURE

Verniciato cromo opaco (US26D)

FINISHES

Matt chrome coating (US26D)

VERSIONE

3

Pigio 3

VERSION

Pigio 3

G4

FINITURE MANIGLIA

Grigio gommato

HANDLE FINISHES

Rubber finish, grey

NG

Nero gommato

Rubber finish, black

AM

Amaranto metallizzato

Metalized amaranth coating

S

SCROCCO

Senza scrocco

TUBULAR LATCH

Without tubular latch

T6

TB-60 entrata mm 60 (standard)

TB-60 backset 2 23/64" (standard)

T7

TB-70 entrata mm 70

TB-70 backset 2 3/4"

T8

TB-80 entrata mm 80

TB-80 backset 3 5/32"

T127

TB-127 entrata mm 127

TB-127 backset 5 1/64"

A6

TBA-60 antiscasso, entrata mm 60

TBA-60 security device, backset 2 23/64"

A7

TBA-70 antiscasso, entrata mm 70

TBA-70 security device, backset 2 3/4"

A8

TBA-80 antiscasso, entrata mm 80

TBA-80 security device, backset 3 5/32"

BORDO SCROCCO

Larghezza mm 22

LATCH FOREND

Width 55/64"

25

Larghezza mm 25

Width 63/64"

T

Quadro

Square

Tondo

Round

CIFRATURE

KD chiavi differenti

KEY-CHANGES

KD keyed differently

A

KA chiavi uguali

KA keyed alike

M

MK chiave maestra

MK master key

G

GMK chiave maestra generale

GMK general master key

K

GGMK chiave gran maestra generale

GGMK grand general master key

CONTROBORDI

Senza controbordo

STRIKING PLATE

Without striking plate

C

Art.1215 quadro

Art.1215 square

10

Art.1210 tondo

Art.1210 round

11

Art.1211 quadro

Art.1211 square

12

Art.1212 tondo

Art.1212 round

91

Art.1291/R nylon nero regolabile

Art.1291/R adjustable, black nylon

ACCESSORI

Set per legno

ACCESSORIES

Kit for wooden door

GL

Set per alluminio

Kit for aluminium door

GA

GC

Set completo

Kit complete

SPESSORI PORTE

mm 30 ÷ 56 destro

DOOR THICKNESS

1 3/16" ÷ 2 13/64" right

SX

mm 30 ÷ 56 sinistro

1 3/16" ÷ 2 13/64" left

L

mm 40 ÷ 70 destro

1 37/64" ÷ 2 3/4" right

LSX

mm 40 ÷ 70 sinistro

1 37/64" ÷ 2 3/4" left

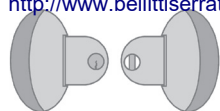

esterno
outside

interno
inside

P13E PER INGRESSO E UFFICI FOR ENTRANCES AND OFFICES

ex Pigio C25

SERIE
P3

FUNZIONE

Bloccabile o sbloccabile dall'esterno con chiave.
 Maniglia interna con girevole.

Con funzione di tipo antipanico UNI EN 179

FUNCTION

Locked or unlocked from outside by key.
 Inside handle with thumbturn.

Anti-panic function UNI EN 179

P13E

Pigio 13/E senza scrocco senza controbordo

Pigio 13/E without latch, without striking plate

6D

FINITURE

Verniciato cromo opaco (US26D)

FINISHES

Matt chrome coating (US26D)

VERSIONE

Pigio 3

VERSION

Pigio 3

G4

FINITURE MANIGLIA

Grigio gommato

HANDLE FINISHES

Rubber finish, grey

NG

Nero gommato

Rubber finish, black

AM

Amaranto metallizzato

Metalized amaranth coating

S

SCROCCO

Senza scrocco

TUBULAR LATCH

Without tubular latch

T6

TB-60 entrata mm 60 (standard)

TB-60 backset 2 23/64" (standard)

T7

TB-70 entrata mm 70

TB-70 backset 2 3/4"

T8

TB-80 entrata mm 80

TB-80 backset 3 5/32"

T127

TB-127 entrata mm 127

TB-127 backset 5 1/64"

A6

TBA-60 antiscasso, entrata mm 60

TBA-60 security device, backset 2 23/64"

A7

TBA-70 antiscasso, entrata mm 70

TBA-70 security device, backset 2 3/4"

A8

TBA-80 antiscasso, entrata mm 80

TBA-80 security device, backset 3 5/32"

BORDO SCROCCO

Larghezza mm 22

LATCH FOREND

Width 55/64"

25

Larghezza mm 25

Width 63/64"

T

Quadro

Square

Tondo

Round

CIFRATURE

KD chiavi differenti

KEY-CHANGES

KD keyed differently

A

KA chiavi uguali

KA keyed alike

M

MK chiave maestra

MK master key

G

GMK chiave maestra generale

GMK general master key

K

GGMK chiave gran maestra generale

GGMK grand general master key

CONTROBORDI

Senza controbordo

STRIKING PLATE

Without striking plate

C

Art.1215 quadro

Art.1215 square

10

Art.1210 tondo

Art.1210 round

11

Art.1211 quadro

Art.1211 square

12

Art.1212 tondo

Art.1212 round

91

Art.1291/R nylon nero regolabile

Art.1291/R adjustable, black nylon

ACCESSORI

Set per legno

ACCESSORIES

Kit for wooden door

GL

Set per alluminio

Kit for aluminium door

GA

GC

Set completo

Kit complete

SPESSORI PORTE

mm 30 ÷ 56 destro

DOOR THICKNESS

1 3/16" ÷ 2 13/64" right

SX

mm 30 ÷ 56 sinistro

1 3/16" ÷ 2 13/64" left

L

mm 40 ÷ 70 destro

1 37/64" ÷ 2 3/4" right

LSX

mm 40 ÷ 70 sinistro

1 37/64" ÷ 2 3/4" left

SERIE
P3

P14 PER CAMERE D'ALBERGO FOR HOTEL ROOMS

ex Pigio C40

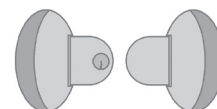

esterno
outside

interno
inside

FUNZIONE

Maniglia esterna sempre fissa, sbloccabile solo dall'esterno con chiave.

Maniglia interna sempre azionabile.

Con funzione di tipo antipanico UNI EN 179

FUNCTION

Fixed outside handle, unlocked only from outside by key.

Inside handle for free passage.

Anti-panic function UNI EN 179

P14

Pigio 14 senza scrocco senza controbordo

Pigio 14 without latch, without striking plate

6D

FINITURE

Verniciato cromo opaco (US26D)

FINISHES

Matt chrome coating (US26D)

VERSIONE

3

Pigio 3

VERSION

Pigio 3

G4

FINITURE MANIGLIA

Grigio gommato

NG

Nero gommato

AM

Amaranto metallizzato

HANDLE FINISHES

Rubber finish, grey

Rubber finish, black

Metalized amaranth coating

S

SCROCCO

Senza scrocco

TUBULAR LATCH

Without tubular latch

T6

TB-60 entrata mm 60 (standard)

TB-60 backset 2 23/64" (standard)

T7

TB-70 entrata mm 70

TB-70 backset 2 3/4"

T8

TB-80 entrata mm 80

TB-80 backset 3 5/32"

T127

TB-127 entrata mm 127

TB-127 backset 5 1/64"

A6

TBA-60 antiscasso, entrata mm 60

TBA-60 security device, backset 2 23/64"

A7

TBA-70 antiscasso, entrata mm 70

TBA-70 security device, backset 2 3/4"

A8

TBA-80 antiscasso, entrata mm 80

TBA-80 security device, backset 3 5/32"

BORDO SCROCCO

Larghezza mm 22

Larghezza mm 25

LATCH FOREND

Width 55/64"

Width 63/64"

25

Quadro

Square

T

Tondo

Round

CIFRATURE

KD chiavi differenti

KEY-CHANGES

KD keyed differently

KA chiavi uguali

KA keyed alike

MK chiave maestra

MK master key

GMK chiave maestra generale

GMK general master key

GGMK chiave gran maestra generale

GGMK grand general master key

CONTROBORDI

Senza controbordo

STRIKING PLATE

Without striking plate

C

Art.1215 quadro

Art.1215 square

10

Art.1210 tondo

Art.1210 round

11

Art.1211 quadro

Art.1211 square

12

Art.1212 tondo

Art.1212 round

91

Art.1291/R nylon nero regolabile

Art.1291/R adjustable, black nylon

ACCESSORI

Set per legno

ACCESSORIES

Kit for wooden door

GL

Set per alluminio

Kit for aluminium door

GA

GC

Set completo

Kit complete

SPESSORI PORTE

mm 30 ÷ 56 destro

mm 30 ÷ 56 sinistro

DOOR THICKNESS

1 3/16" ÷ 2 13/64" right

1 3/16" ÷ 2 13/64" left

SX

L

mm 40 ÷ 70 destro

1 37/64" ÷ 2 3/4" right

LSX

mm 40 ÷ 70 sinistro

1 37/64" ÷ 2 3/4" left

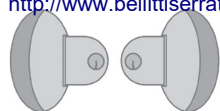

esterno
outside

interno
inside

P15 PER INGRESSO E UFFICI FOR ENTRANCES AND OFFICES

ex Pigio C10

SERIE
P3

FUNZIONE

Bloccabile o sbloccabile da entrambi i lati con chiave.

FUNCTION

Locked or unlocked from both sides by key.

P15 Pigio 15 senza scrocco senza controbordo

Pigio 15 without latch, without striking plate

6D Verniciato cromo opaco (US26D)

FINISHES
Matt chrome coating (US26D)

VERSIONE

3 Pigio 3

VERSION

Pigio 3

FINITURE MANIGLIA

G4 Grigio gommato

HANDLE FINISHES

Rubber finish, grey

NG Nero gommato

Rubber finish, black

AM Amaranto metallizzato

Metalized amaranth coating

SCROCCO

S Senza scrocco

TUBULAR LATCH

Without tubular latch

T6 TB-60 entrata mm 60 (standard)

TB-60 backset 2 23/64" (standard)

T7 TB-70 entrata mm 70

TB-70 backset 2 3/4"

T8 TB-80 entrata mm 80

TB-80 backset 3 5/32"

T127 TB-127 entrata mm 127

TB-127 backset 5 1/64"

A6 TBA-60 antiscasso, entrata mm 60

TBA-60 security device, backset 2 23/64"

A7 TBA-70 antiscasso, entrata mm 70

TBA-70 security device, backset 2 3/4"

A8 TBA-80 antiscasso, entrata mm 80

TBA-80 security device, backset 3 5/32"

BORDO SCROCCO

Larghezza mm 22

LATCH FOREND

Width 55/64"

25 Larghezza mm 25

Width 63/64"

T Quadro

Square

Tondo

Round

CIFRATURE

KD chiavi differenti

KEY-CHANGES

KD keyed differently

KA chiavi uguali

KA keyed alike

MK chiave maestra

MK master key

GMK chiave maestra generale

GMK general master key

GGMK chiave gran maestra generale

GGMK grand general master key

CONTROBORDI

C Senza controbordo

STRIKING PLATE

Without striking plate

Art.1215 quadro

Art.1215 square

10 Art.1210 tondo

Art.1210 round

11 Art.1211 quadro

Art.1211 square

12 Art.1212 tondo

Art.1212 round

91 Art.1291/R nylon nero regolabile

Art.1291/R adjustable, black nylon

ACCESSORI

GL Set per legno

ACCESSORIES

Kit for wooden door

GA Set per alluminio

Kit for aluminium door

GC Set completo

Kit complete

SPESSORI PORTE

mm 30 ÷ 56 destro

DOOR THICKNESS

1 3/16" ÷ 2 13/64" right

mm 30 ÷ 56 sinistro

1 3/16" ÷ 2 13/64" left

mm 40 ÷ 70 destro

1 37/64" ÷ 2 3/4" right

mm 40 ÷ 70 sinistro

1 37/64" ÷ 2 3/4" left

SERIE
P3

P17 PER AULE SCOLASTICHE E UFFICI FOR CLASSROOMS AND OFFICES

ex Pigio C05

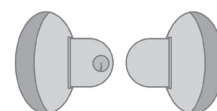

esterno
 outside

interno
 inside

FUNZIONE

Bloccabile o sbloccabile dall'esterno con chiave.
 Maniglia interna sempre azionabile.

Con funzione di tipo antipanico UNI EN 179

FUNCTION

Locked or unlocked from outside by key.
 Inside handle for free passage.

Anti-panic function UNI EN 179

P17

Pigio 17 senza scrocco senza controbordo

Pigio 17 without latch, without striking plate

6D

FINITURE

Verniciato cromo opaco (US26D)

FINISHES

Matt chrome coating (US26D)

VERSIONE

3

Pigio 3

VERSION

Pigio 3

G4

FINITURE MANIGLIA

Grigio gommato

HANDLE FINISHES

Rubber finish, grey

NG

Nero gommato

Rubber finish, black

AM

Amaranto metallizzato

Metalized amaranth coating

S

SCROCCO

Senza scrocco

TUBULAR LATCH

Without tubular latch

T6

TB-60 entrata mm 60 (standard)

TB-60 backset 2 23/64" (standard)

T7

TB-70 entrata mm 70

TB-70 backset 2 3/4"

T8

TB-80 entrata mm 80

TB-80 backset 3 5/32"

T127

TB-127 entrata mm 127

TB-127 backset 5 1/64"

A6

TBA-60 antiscasso, entrata mm 60

TBA-60 security device, backset 2 23/64"

A7

TBA-70 antiscasso, entrata mm 70

TBA-70 security device, backset 2 3/4"

A8

TBA-80 antiscasso, entrata mm 80

TBA-80 security device, backset 3 5/32"

BORDO SCROCCO

Larghezza mm 22

LATCH FOREND

Width 55/64"

25

Larghezza mm 25

Width 63/64"

T

Quadro

Square

Tondo

Round

CIFRATURE

KD chiavi differenti

KEY-CHANGES

KD keyed differently

A

KA chiavi uguali

KA keyed alike

M

MK chiave maestra

MK master key

G

GMK chiave maestra generale

GMK general master key

K

GGMK chiave gran maestra generale

GGMK grand general master key

CONTROBORDI

Senza controbordo

STRIKING PLATE

Without striking plate

C

Art.1215 quadro

Art.1215 square

10

Art.1210 tondo

Art.1210 round

11

Art.1211 quadro

Art.1211 square

12

Art.1212 tondo

Art.1212 round

91

Art.1291/R nylon nero regolabile

Art.1291/R adjustable, black nylon

ACCESSORI

Set per legno

ACCESSORIES

Kit for wooden door

GL

Set per alluminio

Kit for aluminium door

GA

Set completo

Kit complete

GC

SPESSORI PORTE

mm 30 ÷ 56 destro

DOOR THICKNESS

1 3/16" ÷ 2 13/64" right

SX

mm 30 ÷ 56 sinistro

1 3/16" ÷ 2 13/64" left

L

mm 40 ÷ 70 destro

1 37/64" ÷ 2 3/4" right

LSX

mm 40 ÷ 70 sinistro

1 37/64" ÷ 2 3/4" left

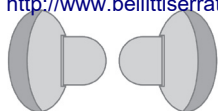

esterno
outside

interno
inside

P20 PER APPLICAZIONI VARIE FOR DIFFERENT APPLICATIONS

SERIE
P3

ex Pigio C70

FUNZIONE

Doppia maniglia fissa.

FUNCTION

Double fixed handle.

P20

Pigio 20

Pigio 20

6D

FINITURE CORPO

Verniciato cromo opaco (US26D)

BODY FINISHES

Matt chrome coating (US26D)

VERSIONE

Pigio 3

VERSION

Pigio 3

3

FINITURE MANIGLIA

Grigio gommato

HANDLE FINISHES

Rubber finish, grey

G4

Nero gommato

Rubber finish, black

NG

AM

Amaranto metallizzato

Metalized amaranth coating

SERIE
P3

P21 PER APPLICAZIONI VARIE FOR DIFFERENT APPLICATIONS

ex Pigio C60

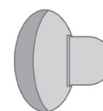

esterno
outside

FUNZIONE

Maniglia esterna fissa.
Piastra interna per fissaggio.

FUNCTION

Outside fixed handle.
Inside fixing plate.

P21

Pigio 21

Pigio 21

6D

FINITURE CORPO

Verniciato cromo opaco (US26D)

BODY FINISHES

Matt chrome coating (US26D)

VERSIONE

3

Pigio 3

VERSION

Pigio 3

G4

FINITURE MANIGLIA

Grigio gommato

HANDLE FINISHES

Rubber finish, grey

NG

Nero gommato

Rubber finish, black

AM

Amaranto metallizzato

Metalized amaranth coating



esterno
outside

interno
inside

P24 PER CAMERE D'ALBERGO FOR HOTEL ROOMS

ex Pigio C50

SERIE
P3

FUNZIONE

Maniglia esterna senza pulsante, apertura solo con chiave.

Maniglia interna con girevole che aziona il segnalatore di occupato.

Con funzione di tipo antipanico UNI EN 179

P24

Pigio 24 senza scrocco senza controbordo

FINITURE

6D

Verniciato cromo opaco (US26D)

VERSIONE

3

Pigio 3

FINITURE MANIGLIA

G4

Grigio gommato

NG

Nero gommato

AM

Amaranto metallizzato

SCROCCO

S

Senza scrocco

T6

TB-60 entrata mm 60 (standard)

T7

TB-70 entrata mm 70

T8

TB-80 entrata mm 80

T127

TB-127 entrata mm 127

A6

TBA-60 antiscasso, entrata mm 60

A7

TBA-70 antiscasso, entrata mm 70

A8

TBA-80 antiscasso, entrata mm 80

BORDO SCROCCO

25

Larghezza mm 22

Larghezza mm 25

T

Quadro

Tondo

CIFRATURE

A

KD chiavi differenti

M

KA chiavi uguali

G

MK chiave maestra

K

GMK chiave maestra generale

GGMK chiave gran maestra generale

CONTROBORDI

C

Senza controbordo

10

Art.1215 quadro

11

Art.1210 tondo

12

Art.1211 quadro

91

Art.1212 tondo

Art.1291/R nylon nero regolabile

ACCESSORI

GL

Set per legno

G37

Set per alluminio

GC

Set completo

SPESSORI PORTE

SX

mm 30 ÷ 56 destro

L

mm 30 ÷ 56 sinistro

LSX

mm 40 ÷ 70 destro

mm 40 ÷ 70 sinistro

FUNCTION

Outside fixed handle, unlocked only by key.

Inside handle with tumbturn acting on occupancy indicator.

Anti-panic function UNI EN 179

Pigio 24 without latch, without striking plate

FINISHES

Matt chrome coating (US26D)

VERSION

Pigio 3

HANDLE FINISHES

Rubber finish, grey

Rubber finish, black

Metalized amaranth coating

TUBULAR LATCH

Without tubular latch

TB-60 backset 2 23/64" (standard)

TB-70 backset 2 3/4"

TB-80 backset 3 5/32"

TB-127 backset 5 1/64"

TBA-60 security device, backset 2 23/64"

TBA-70 security device, backset 2 3/4"

TBA-80 security device, backset 3 5/32"

LATCH FOREND

Width 55/64"

Width 63/64"

Square

Round

KEY-CHANGES

KD keyed differently

KA keyed alike

MK master key

GMK general master key

GGMK grand general master key

STRIKING PLATE

Without striking plate

Art.1215 square

Art.1210 round

Art.1211 square

Art.1212 round

Art.1291/R adjustable, black nylon

ACCESSORIES

Kit for wooden door

Kit for aluminium door

Kit complete

DOOR THICKNESS

1 3/16" ÷ 2 13/64" right

1 3/16" ÷ 2 13/64" left

1 37/64" ÷ 2 3/4" right

1 37/64" ÷ 2 3/4" left

SERIE
P3

FINITURE MANIGLIE A RICHIESTA
HANDLES FINISHING ON REQUEST

Per serratura

For lock

LCI	Legno ciliegio	<i>Cherry wood</i>
LNO	Legno noce	<i>Walnut wood</i>
PN	Pelle nera	<i>Black leather</i>

i Quantità minima per ordine 50 pz.

Minimum order quantity 50 pcs



pigio 1



pigio 2



pigio 3

info e preventivi
<http://www.bellittiserrature.it/contact.asp>

CONTROBORDI STRIKING PLATES

SERIE
P

ex 1210

PCBP875T



Controbordo arrotondato

Round-edge striking plate

Acciaio

Steel

FINITURE

FINISHES

Nichelato (US15)

Nickel plated (US15)

15

C

Confezionato

Packaged

ex 1211

PCBP896

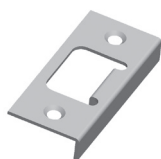

Controbordo refilato per porte con battuta

Striking plate without forend for rebated doors

Acciaio

Steel

FINITURE

FINISHES

Nichelato (US15)

Nickel plated (US15)

15

C

Confezionato

Packaged

ex 1212

PCBP896T



Controbordo refilato per porte con battuta arrotondato

Round-edge striking plate without forend for rebated doors

Acciaio

Steel

FINITURE

FINISHES

Nichelato (US15)

Nickel plated (US15)

15

C

Confezionato

Packaged

ex 1213

PCBP1213



Controbordo

Striking plate

Acciaio

Steel

FINITURE

FINISHES

Nichelato (US15)

Nickel plated (US15)

15

C

Confezionato

Packaged

ex 1214

PCBP1214T



Controbordo arrotondato

Round-edge striking plate

Acciaio

Steel

FINITURE

FINISHES

Nichelato (US15)

Nickel plated (US15)

15

C

Confezionato

Packaged

SERIE
P

CONTROBORDI STRIKING PLATES

ex 1215



PCBP875

Controbordo arrotondato

Round-edge striking plate

Acciaio

Steel

15

FINITURE

Nichelato (US15)

FINISHES

Nickel plated (US15)

C

Confezionato

Packaged

ex 1143



PCBP1143

Controbordo arrotondato

Round-edge striking plate

Acciaio

Steel

14

FINITURE

Nichelato (US14)

FINISHES

Nickel plated (US14)

C

Confezionato

Packaged

ex 1217



PCBP1217

Controbordo "UL"

"UL" Striking plate

Acciaio

Steel

15

FINITURE

Nichelato (US15)

FINISHES

Nickel plated (US15)

C

Confezionato

Packaged

ex 1218



PCBP1218

Controbordo tondo "UL"

"UL" Round-edge striking plate

Acciaio

Steel

15

FINITURE

Nichelato (US15)

FINISHES

Nickel plated (US15)

C

Confezionato

Packaged

CONTROBORDI STRIKING PLATES

SERIE
P

ex 1136

PCBP1136

Controbordo per profilati
in alluminio

Striking plate
for aluminium profiles

Polimero nero

Black Polymer

C

Confezionato

Packaged



ex 1137

PCBP1137

Controbordo per profilati
in alluminio

Striking plate
for aluminium profiles

Polimero nero

Black Polymer

C

Confezionato

Packaged



ex 1138

PCBP1138

Controbordo per profilati
in alluminio

Striking plate
for aluminium profiles

Polimero nero

Black Polymer

C

Confezionato

Packaged

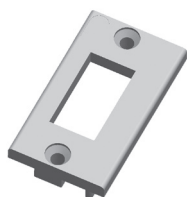

ex 1139

PCBP1139

Controbordo per profilati
in alluminio

Striking plate
for aluminium profiles

Polimero nero

Black Polymer

C

Confezionato

Packaged



1291/R

NCBP1291R

Controbordo regolabile
per profilati in alluminio

Adjustable striking plate
for aluminium profiles

Polimero nero

Black Polymer

C

Confezionato

Packaged

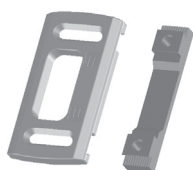

ex 722-725-732-735

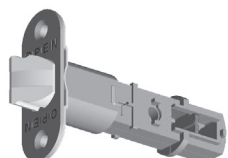
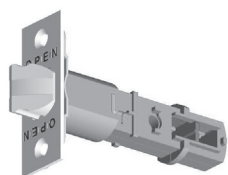

PTB

Scrocco tubolare

Tubular latch

Bordo in acciaio

Steel edge

60
60T
70
70T
80
80T
127
127T

ENTRATA

BACKSET

mm 60
mm 60 tondo
mm 70
mm 70 tondo
mm 80
mm 80 tondo
mm 127
mm 127 tondo

2 3/8"
2 3/8" Round plate
2 3/4"
2 3/4" Round plate
3 1/8"
3 1/8"
5"
5" Round plate

25

BORDO

FOREND PLATE

Larghezza mm 22

Width 55/64"

Larghezza mm 25

Width 63/64"

14

FINITURE

FINISHES

Nichelato (US14)

Nickel plated (US14)

R

Confezionato

Packaged

ex 742-745-752-755

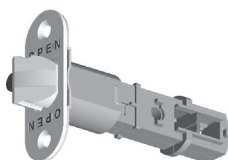
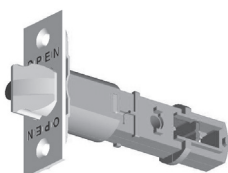

PTBA

Scrocco tubolare con antiscasso

Tubular latch with security device

Bordo in acciaio

Steel edge

60
60T
70
70T
80
80T
127
127T

ENTRATA

BACKSET

mm 60
mm 60 tondo
mm 70
mm 70 tondo
mm 80
mm 80 tondo
mm 127
mm 127 tondo

2 3/8"
2 3/8" Round plate
2 3/4"
2 3/4" Round plate
3 1/8"
3 1/8"
5"
5" Round plate

25

BORDO

FOREND PLATE

Larghezza mm 22

Width 55/64"

Larghezza mm 25

Width 63/64"

14

FINITURE

FINISHES

Nichelato (US14)

Nickel plated (US14)

R

Confezionato

Packaged

ex 942-952

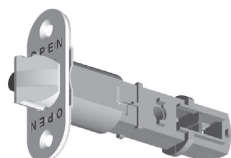
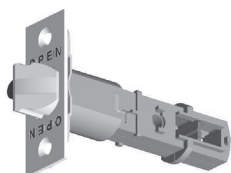

PTBF

Scrocco antiscasso "UL"

"UL" Square security device latch

Bordo in acciaio

Steel edge

60

ENTRATA

BACKSET

60T

mm 60

2 3/8"

70

mm 60 tondo

2 3/8" Round plate

70T

mm 70

2 3/4"

80

mm 70 tondo

2 3/4" Round plate

80T

mm 80

3 1/8"

mm 80 tondo

3 1/8"

25

BORDO

FOREND PLATE

Larghezza mm 22

Width 55/64"

Larghezza mm 25

Width 63/64"

14

FINITURE

FINISHES

Nichelato (US14)

Nickel plated (US14)

R

Confezionato

Packaged

ex 770-780

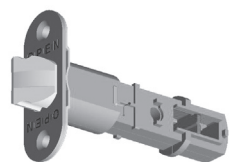

PTB

Scrocco tubolare per porte vetro

Tubular latch for glass doors

Bordo in acciaio

Steel edge

70GL

ENTRATA

BACKSET

A70GL

Standard

Standard

Antiscasso

Security device

14

FINITURE

FINISHES

Nichelato (US14)

Nickel plated (US14)

R

Confezionato

Packaged

ex 1531

PGL531



CG

DG

6D

T7V

A7V

Piastra singola per porte vetro

Single plate for glass door

FINITURE

Polimero nero
Polimero grigio chiaro
Polimero grigio scuro
Polimero verniciata cromo opaco

FINISHES

Polymer, black
Polymer, light grey
Polymer, dark grey
Polymer, matt chrome coated

SCROCCO

Senza scrocco
Standard
Antiscasso

LATCH

Without latch
Standard
Security device latch

ex 1533

PGL533



CG

DG

6D

Controbordo per anta doppia GL

Striking plate for double door GL

FINITURE

Polimero nero
Polimero grigio chiaro
Polimero grigio scuro
Polimero verniciata cromo opaco

FINISHES

Polymer, black
Polymer, light grey
Polymer, dark grey
Polymer, matt chrome coated

ex 1532

PGL532



CG

DG

6D

T7V

A7V

Piastra doppia per porte vetro

Double plate for glass door

FINITURE

Polimero nero
Polimero grigio chiaro
Polimero grigio scuro
Polimero verniciata cromo opaco

FINISHES

Polymer, black
Polymer, light grey
Polymer, dark grey
Polymer, matt chrome coated

SCROCCO

Senza scrocco
Standard
Antiscasso

LATCH

Without latch
Standard
Security device latch

ex 1112

PSUP1112NE



Supporto per legno

Latch - Holder for wooden door

Polimero nero

Black polymer

ex 1113

PSUP1113NE



Supporto per alluminio

Latch - Holder for aluminium door

Polimero nero

Black polymer

ex 1140

PDIST114



**Distanziale sottobordo
per alluminio**

**Faceplate spacer
for aluminium**

Polimero nero

Black polymer

ex 1114



PADAT1114NE

Supporto per adattatori

Polimero nero

Mount for adaptor

Black polymer

ex 1512

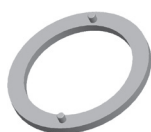

PADAT1512NE

Adattatore per foro Ø mm 52

Polimero nero

Hole adaptor Ø mm 52

Black polymer

ex 1514

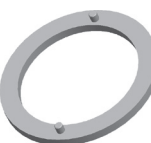

PADAT1514NE

Adattatore per foro Ø mm 54

Polimero nero

Hole adaptor Ø mm 54

Black polymer

ex 1520



P1520

Segnalatore di occupato

Polimero nero

Art.P12-P12E-P13-P15

Art.P24

Occupancy indicator

Black polymer

Art.P12-P12E-P13-P15

Art.P24

24

FINITURE

Verniciato nero

Verniciato grigio chiaro

Verniciato grigio scuro

FINISHES

Black coating

Light grey coating

Dark grey coating

NE

CG

DG

ex 1521



P1521

Piastra di rinforzo

Acciaio

Support plate

Steel

FINITURE

Verniciato nero

Verniciato grigio chiaro

Verniciato grigio scuro

FINISHES

Black coating

Light grey coating

Dark grey coating

NE

CG

DG

SERIE
P

ACCESSORI
ACCESSORIES

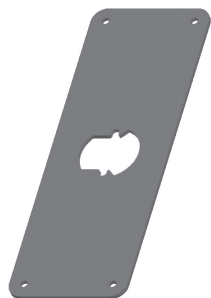

ex 1535

P1535	Placca Acciaio	Plate Steel
NE	FINITURE Nero	FINISHES Black

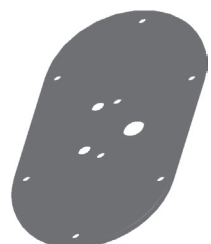

ex 1540

P1540FNEUL	Placca "UL" Acciaio	Plate "UL" Steel
-------------------	-------------------------------	----------------------------

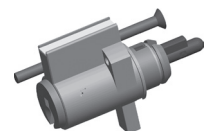

PGRCIL	Gruppo cilindro	Cylinder group
1315R	Singolo KD	Single KD
1515R	Coppia KD	Double KD
A1315R	Singolo KA	Single KA
A1515R	Coppia KA	Double KA
M1315R	Singolo MK	Single MK
M1515R	Coppia MK	Double MK
G1315R	Singolo GMK	Single GMK
G1515R	Coppia GMK	Double GMK
K1315R	Singolo GGMK	Single GGMK
K1515R	Coppia GGMK	Double GGMK



ex 82CD

CHEP55	Chiave Ottone	Key Brass
OCA	CIFRATURA Non cifrata	KEY-CHANGES Blank
OCAC	Cifrata	Cutted Key

PGRA	Kit adattatori	Adaptor kit
AC	Per alluminio	For aluminium
CC	Completo	Complete
UL	UL (includo 2 placche Art.1540)	UL (included 2 plates Art.1540)
37C	Art-P12E-P24	Art.P12E-P24



GLISS

info e preventivi
<http://www.bellittiserrature.it/contact.asp>

GLISS CERNIERA PER PORTE VETRO

HINGE FOR GLASS DOORS

SERIE
GA



GAHA	Cerniera GLISS	GLISS hinge
MODELLO		MODEL
1ST	Standard	Standard
FINITURE		FINISHES
15*	Nichel opaco (US15)	Matt nickel (US15)
26	Cromo lucido	Polish chrome
6D	Cromo opaco	Matt chrome
NE	Verniciato nero	Black coating

* richiesta minima 300 pz * minimum quantity 300 pcs



GAHA	Cerniera GLISS	GLISS hinge
MODELLO		MODEL
1L	Braccio lungo	Long arm
FINITURE		FINISHES
6D	Cromo opaco (US26D)	Matt chrome (US26D)



GAHA	Cerniera GLISS	GLISS hinge
MODELLO		MODEL
1G1	Vetro-vetro	Glass to glass
FINITURE		FINISHES
6D	Cromo opaco (US26D)	Matt chrome (US26D)

SERIE
GA

GLISS CERNIERA PER PORTE VETRO

HINGE FOR GLASS DOORS



GAHA	Cerniera GLISS	GLISS hinge
MODELLO		MODEL
1P1	Perno singolo	Single pin
FINITURE		FINISHES
6D	Cromo opaco (US26D)	Matt chrome (US26D)



GAHA1P1GCER	Kit perno singolo e cuffia	Kit single pin with cover
M	Per metallo	For metal



L	Per legno	For wood
FINITURE		FINISHES
6D	Cromo opaco (US26D)	Matt chrome (US26D)



GAHA	Cerniera GLISS	GLISS hinge
MODELLO		MODEL
1P2	Perno doppio	Double pin
FINITURE		FINISHES
6D	Cromo opaco (US26D)	Matt chrome (US26D)



GAHA1P2GCER	Kit perno doppio con cuffia	Kit double pin with cover
M	Per metallo	For metal



L	Per legno	For wood
FINITURE		FINISHES
6D	Cromo opaco (US26D)	Matt chrome (US26D)



GUARDIAN

info e preventivi
<http://www.bellittiserrature.it/contact.asp>



DC110 CHIUDIORTA AEREI DOOR CLOSERS

**SERIE
 DC**

DADC110	DC110	DC110
03	FORZA Variabile	POWER Variable
WA	BRACCI Senza braccio - solo corpo	ARMS Without arm - only body
ST	Con braccio standard	With standard arm
HO	Con braccio con fermo	With hold open arm
HS	Con braccio a slitta con fermo	With sliding arm hold open
NA	FINITURE Verniciato argento	FINISHES Silver coating
NE	Verniciato nero	Black coating
	CONFEZIONI Scatola da 1 pz	PACKAGING Boxed in 1's

BRACCI A PARTE

SEPARATE ARMS/SPARE PARTS

DADA110ARST	Braccio standard Art.110-150-160	Standard arm Art.110-150-160
--------------------	----------------------------------	------------------------------



DADA110ARHO	Braccio con fermo Art.110-150-160	Hold open arm Art.110-150-160
--------------------	-----------------------------------	-------------------------------



DADA310ARHS	Braccio a slitta con fermo	Sliding arm hold open
--------------------	----------------------------	-----------------------



NA	FINITURE Verniciato argento	FINISHES Silver coating
NE	Verniciato nero	Black coating

CARATTERISTICHE TECNICHE

TECHNICAL FEATURES

Forza variabile (*)	EN 2-3-4	Variable closing power	EN 2-3-4
Massima larghezza porta	EN 2 mm 850 EN 3 mm 950 EN 4 mm 1100	Maximum door width	EN 2 mm 850 EN 3 mm 950 EN 4 mm 1100
Peso porta	EN 2 Kg 25 ÷ 45 EN 3 Kg 45 ÷ 60 EN 4 Kg 60 ÷ 80	Door weight	EN 2 Kg 25 ÷ 45 EN 3 Kg 45 ÷ 60 EN 4 Kg 60 ÷ 80
Esecuzione per porta	DIN destro DIN sinistro	Non - handed	DIN right DIN left
Velocità di chiusura e colpo finale regolabili da 2 valvole indipendenti	180° - 10° 10° - 0°	Adjustable closing and final latch speed by means of 2 independent valves	180° - 10° 10° - 0°
Dimensioni	Lunghezza mm 177 Larghezza mm 42 Altezza mm 64	Dimensions	Length mm 177 Width mm 42 Height mm 64
Confezione	Scatola da 1 pz	Packaging	Box in 1's
Peso (inclusa confezione)	Kg 1,60	Weight (box included)	Kg 1,60
Fornito con	6 viti di fissaggio per legno 6 viti di fissaggio per metallo	Supplied with	6 fixing screws for wood 6 fixing screws for metal

(*) Con braccio a slitta la forza (EN) diminuisce di 1 livello (circa 30%)

(*) With the sliding arm the force (EN) decreases of 1 power level (about 30%)

**SERIE
DC**

DC150 CHIUDIPIORTA AEREI DOOR CLOSERS

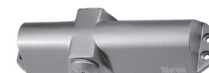

DADC150	DC150	DC150
24	FORZA Variabile	POWER Variable
WA	BRACCI Senza braccio - solo corpo	ARMS Without arm - only body
ST	Con braccio standard	With standard arm
HO	Con braccio con fermo	With hold open arm
HS	Con braccio a slitta con fermo	With sliding arm hold open
NA	FINITURE Verniciato argento	FINISHES Silver coating
NE	Verniciato nero	Black coating
	CONFEZIONI Scatola da 1 pz	PACKAGING Boxed in 1's



DADA110ARST	BRACCI A PARTE Braccio standard Art.110-150-160	SEPARATE ARMS/SPARE PARTS Standard arm Art.110-150-160
--------------------	---	--



DADA110ARHO	Braccio con fermo Art.110-150-160	Hold open arm Art.110-150-160
--------------------	-----------------------------------	-------------------------------



DADA310ARHS	Braccio a slitta con fermo	Sliding arm hold open
--------------------	----------------------------	-----------------------

NA	FINITURE Verniciato argento	FINISHES Silver coating
NE	Verniciato nero	Black coating

CARATTERISTICHE TECNICHE

Forza variabile (*)	EN 2-3-4
Massima larghezza porta	EN 2 mm 850 EN 3 mm 950 EN 4 mm 1100
Peso porta	EN 2 Kg 25 ÷ 45 EN 3 Kg 45 ÷ 60 EN 4 Kg 60 ÷ 80
Esecuzione per porta	DIN destro DIN sinistro
Velocità di chiusura e colpo finale regolabili da 2 valvole indipendenti	180° - 10° (105° - 10°) 10° - 0°
Dimensioni	Lunghezza mm 219 Larghezza mm 58 Altezza mm 42
Confezione	Scatola da 1 pz
Peso (inclusa confezione)	Kg 1,60
Fornito con	6 viti di fissaggio per legno 6 viti di fissaggio per metallo

Modello EN 3 conforme alla normativa EN 1154 - EN 1634 CE

(*) Con braccio a slitta la forza (EN) diminuisce di 1 livello (circa 30%)

TECHNICAL FEATURES

Variable closing power (*)	EN 2-3-4
Maximum door width	EN 2 mm 850 EN 3 mm 950 EN 4 mm 1100
Door weight	EN 2 Kg 25 ÷ 45 EN 3 Kg 45 ÷ 60 EN 4 Kg 60 ÷ 80
Non - handed	DIN right DIN left
Adjustable closing and final latch speed by means of 2 independent valves	180° - 10° (105° - 10°) 10° - 0°
Dimensions	Length mm 219 Width mm 58 Height mm 42
Packaging	Box in 1's
Weight (box included)	Kg 1,60
Supplied with	6 fixing screws for wood 6 fixing screws for metal

EN 3 certified product EN 1154 - EN 1634 CE

(*) With the sliding arm the force (EN) decreases of 1 power level (about 30%)

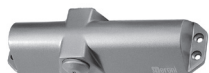

DC160 CHIUDIORTA AEREI DOOR CLOSERS

**SERIE
DC**

DADC160	DC160	DC160
36	FORZA Regolabile tramite molla	POWER Adjustable by springs
WA	BRACCI Senza braccio - solo corpo	ARMS Without arm - only body
ST	Con braccio standard	With standard arm
HO	Con braccio con fermo	With hold open arm
HS	Con braccio a slitta con fermo	With sliding arm hold open
NA	FINITURE Verniciato argento	FINISHES Silver coating
NE	Verniciato nero	Black coating
	CONFEZIONI Scatola da 1 pz	PACKAGING Boxed in 1's

BRACCI A PARTE

SEPARATE ARMS/SPARE PARTS

DADA110ARST	Braccio standard Art.110-150-160	Standard arm Art.110-150-160
--------------------	----------------------------------	------------------------------

DADA110ARHO	Braccio con fermo Art.110-150-160	Hold open arm Art.110-150-160
--------------------	-----------------------------------	-------------------------------

DADA310ARHS	Braccio a slitta con fermo	Sliding arm hold open
--------------------	----------------------------	-----------------------

NA	FINITURE Verniciato argento	FINISHES Silver coating
NE	Verniciato nero	Black coating

CARATTERISTICHE TECNICHE

TECHNICAL FEATURES

Forza regolabile (*)	EN 3-4-5-6	Adjustable closing power (*)	EN 3-4-5-6
Massima larghezza porta	EN 3 mm 950 EN 4 mm 1100 EN 5 mm 1250 EN 6 mm 1450	Maximum door width	EN 3 mm 950 EN 4 mm 1100 EN 5 mm 1250 EN 6 mm 1450
Peso porta	EN 3 Kg 40 ÷ 60 EN 4 Kg 60 ÷ 80 EN 5 Kg 80 ÷ 100 EN 6 Kg 100 ÷ 120	Door weight	EN 3 Kg 40 ÷ 60 EN 4 Kg 60 ÷ 80 EN 5 Kg 80 ÷ 100 EN 6 Kg 100 ÷ 120
Esecuzione per porta	DIN destro DIN sinistro	Non - handed	DIN right DIN left
Velocità di chiusura e colpo finale regolabili da 2 valvole indipendenti	180° - 10° (105° - 10°) 10° - 0°	Adjustable closing and final latch speed by means of 2 independent valves	180° - 10° (105° - 10°) 10° - 0°
Dimensioni	Lunghezza mm 297 Larghezza mm 62 Altezza mm 46	Dimensions	Length mm 297 Width mm 62 Height mm 46
Confezione	Scatola da 1 pz	Packaging	Box in 1's
Peso (inclusa confezione)	Kg 2,40	Weight (box included)	Kg 2,40
Fornito con	6 viti di fissaggio per legno 6 viti di fissaggio per metallo	Supplied with	6 fixing screws for wood 6 fixing screws for metal

Modello EN 3 conforme alla normativa EN 1154 - EN 1634 CE

EN 3 certified product EN 1154 - EN 1634 CE

(*) Con braccio a slitta la forza (EN) diminuisce di 1 livello (circa 30%)

(*) With the sliding arm the force (EN) decreases of 1 power level (about 30%)

**SERIE
DC**

DC210 CHIUDIPIORTA AEREI DOOR CLOSERS



DADC210	DC210	DC210
24	FORZA Variabile	POWER Variable
WA	BRACCI Senza braccio - solo corpo	ARMS Without arm - only body
ST	Con braccio standard	With standard arm
HO	Con braccio con fermo	With hold open arm
HS	Con braccio a slitta con fermo	With sliding arm hold open
NA	FINITURE Verniciato argento	FINISHES Silver coating
NE	Verniciato nero	Black coating
	CONFEZIONI Scatola da 1 pz	PACKAGING Boxed in 1's

	BRACCI A PARTE	SEPARATE ARMS/SPARE PARTS
DADA310ARST	Braccio standard Art.210-310	Standard arm Art.210-310

DADA310ARHO	Braccio con fermo Art.210-310	Hold open arm Art.210-310
--------------------	-------------------------------	---------------------------

DADA310ARHS	Braccio a slitta con fermo	Sliding arm hold open
--------------------	----------------------------	-----------------------

	FINITURE	FINISHES
NA	Verniciato argento	Silver coating
NE	Verniciato nero	Black coating

CARATTERISTICHE TECNICHE

Forza variabile (*)	EN 2-3-4
Massima larghezza porta	EN 2 mm 850 EN 3 mm 950 EN 4 mm 1100
Peso porta	EN 2 Kg 25 ÷ 45 EN 3 Kg 45 ÷ 60 EN 4 Kg 60 ÷ 80
Esecuzione per porta	DIN destro DIN sinistro
Velocità di chiusura e colpo finale regolabili da 2 valvole indipendenti	180° - 10° 10° - 0°
Dimensioni	Lunghezza mm 207 Larghezza mm 55 Altezza mm 46
Confezione	Scatola da 1 pz
Peso (inclusa confezione)	Kg 2,15
Fornito con	6 viti di fissaggio per legno 6 viti di fissaggio per metallo

(*) Con braccio a slitta la forza (EN) diminuisce di 1 livello (circa 30%)

TECHNICAL FEATURES

Variable closing power (*)	EN 2-3-4
Maximum door width	EN 2 mm 850 EN 3 mm 950 EN 4 mm 1100
Door weight	EN 2 Kg 25 ÷ 45 EN 3 Kg 45 ÷ 60 EN 4 Kg 60 ÷ 80
Non - handed	DIN right DIN left
Adjustable closing and final latch speed by means of 2 independent valves	180° - 10° 10° - 0°
Dimensions	Length mm 207 Width mm 55 Height mm 46
Packaging	Box in 1's
Weight (box included)	Kg 2,15
Supplied with	6 fixing screws for wood 6 fixing screws for metal

(*) With the sliding arm the force (EN) decreases of 1 power level (about 30%)

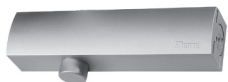

DC310 CHIUDIORTA AEREI DOOR CLOSERS

**SERIE
 DC**

DADC310	DC310	DC310
25	FORZA Regolabile tramite molla	POWER Adjustable by springs
WA	BRACCI Senza braccio - solo corpo	ARMS Without arm - only body
ST	Con braccio standard	With standard arm
HO	Con braccio con fermo	With hold open arm
HS	Con braccio a slitta con fermo	With sliding arm hold open
NA	FINITURE Verniciato argento	FINISHES Silver coating
NE	Verniciato nero	Black coating
	CONFEZIONI Scatola da 1 pz	PACKAGING Boxed in 1's

BRACCI A PARTE

SEPARATE ARMS/SPARE PARTS

DADA310ARST	Braccio standard Art.210-310	Standard arm Art.210-310
DADA310ARHO	Braccio con fermo Art.210-310	Hold open arm Art.210-310
DADA310ARHS	Braccio a slitta con fermo	Sliding arm hold open
NA	FINITURE Verniciato argento	FINISHES Silver coating
NE	Verniciato nero	Black coating

CARATTERISTICHE TECNICHE

TECHNICAL FEATURES

Forza regolabile (*)	EN 2-3-4-5	Adjustable closing power (*)	EN 2-3-4-5
Massima larghezza porta	EN 2 mm 850 EN 3 mm 950 EN 4 mm 1100 EN 5 mm 1250	Maximum door width	EN 2 mm 850 EN 3 mm 950 EN 4 mm 1100 EN 5 mm 1250
Peso porta	EN 2 Kg 25 ÷ 45 EN 3 Kg 45 ÷ 60 EN 4 Kg 60 ÷ 80 EN 5 Kg 80 ÷ 110	Door weight	EN 2 Kg 25 ÷ 45 EN 3 Kg 45 ÷ 60 EN 4 Kg 60 ÷ 80 EN 5 Kg 80 ÷ 110
Esecuzione per porta	DIN destro DIN sinistro	Non - handed	DIN right DIN left
Velocità di chiusura e colpo finale regolabili da 2 valvole indipendenti	180° - 10° 10° - 0°	Adjustable closing and final latch speed by means of 2 independent valves	180° - 10° 10° - 0°
Dimensioni	Lunghezza mm 236 Larghezza mm 55 Altezza mm 46	Dimensions	Length mm 236 Width mm 55 Height mm 46
Confezione	Scatola da 1 pz	Packaging	Box in 1's
Peso (inclusa confezione)	Kg 2,30	Weight (box included)	Kg 2,30
Fornito con	6 viti di fissaggio per legno 6 viti di fissaggio per metallo	Supplied with	6 fixing screws for wood 6 fixing screws for metal

(*) Con braccio a slitta la forza (EN) diminuisce di 1 livello (circa 30%)

(*) With the sliding arm the force (EN) decreases of 1 power level (about 30%)

**SERIE
DC**

DC510 CHIUDIORTA AEREI DOOR CLOSERS



DADC510	DC510	DC510
02	FORZA EN 2 Fissa	POWER EN 2 Power size
HS	BRACCIO A a slitta con fermo	ARM Sliding arm hold open
NA	FINITURE Verniciato argento	FINISHES Silver coating
NE	Verniciato nero	Black coating
	CONFEZIONI Scatola da 1 pz	PACKAGING Boxed in 1's

CARATTERISTICHE TECNICHE

Forza fissa	EN 2
Massima larghezza porta	EN 2 mm 850
Peso porta	EN 2 Kg 25 ÷ 45
Esecuzione per porta	DIN destro DIN sinistro
Velocità di chiusura e colpo finale regolabili da 2 valvole indipendenti	120° - 10° 10° - 0°
Dimensioni	Lunghezza mm 275 Larghezza mm 32 Altezza mm 62
Confezione	Scatola da 1 pz
Peso (inclusa confezione)	Kg 1,80
Fornito con	6 viti di fissaggio per legno 6 viti di fissaggio per metallo

TECHNICAL FEATURES

Power size	EN 2
Maximum door width	EN 2 mm 850
Door weight	EN 2 Kg 25 ÷ 45
Non - handed	DIN right DIN left
Adjustable closing and final latch speed by means of 2 independent valves	120° - 10° 10° - 0°
Dimensions	Length 10 53/64" Width 1 17/64" Height 2 7/16"
Packaging	Box in 1's
Weight (box included)	Kg 1,80
Supplied with	6 fixing screws for wood 6 fixing screws for metal



DC550 CHIUDIORTA AEREI DOOR CLOSERS

**SERIE
 DC**

DADC550	DC550	DC550
24	FORZA EN 2-3-4 Regolabile tramite molla	POWER EN 2-3-4 Adjustable by springs
HS	BRACCIO A a slitta con fermo	ARM Sliding arm hold open
NA	FINITURE Verniciato argento	FINISHES Silver coating
NE	Verniciato nero	Black coating
	CONFEZIONI Scatola da 1 pz	PACKAGING Boxed in 1's

CARATTERISTICHE TECNICHE

Forza regolabile	EN 2-3-4
Massima larghezza porta	EN 2 mm 850 EN 3 mm 950 EN 4 mm 1100
Peso porta	EN 2 Kg 25 ÷ 45 EN 3 Kg 45 ÷ 60 EN 4 Kg 60 ÷ 80
Attenzione solo per apertura 90°	EN 5 mm 1250 EN 5 Kg 80 ÷ 100
Esecuzione per porta	DIN destro DIN sinistro
Velocità di chiusura e colpo finale regolabili da 2 valvole indipendenti	120° - 10° 10° - 0°
Dimensioni	
Corpo	Lunghezza mm 255
Piastra	Lunghezza mm 300 Larghezza mm 37 Altezza mm 75
Confezione	Scatola da 1 pz
Peso (inclusa confezione)	Kg 2,20
Fornito con	6 viti di fissaggio per legno 6 viti di fissaggio per metallo

TECHNICAL FEATURES

Adjustable closing power	EN 2-3-4
Maximum door width	EN 2 mm 850 EN 3 mm 950 EN 4 mm 1100
Door weight	EN 2 Kg 25 ÷ 45 EN 3 Kg 45 ÷ 60 EN 4 Kg 60 ÷ 80
Attention only for 90° opening	EN 5 mm 1250 EN 5 Kg 80 ÷ 100
Non - handed	DIN right DIN left
Adjustable closing and final latch speed by means of 2 independent valves	120° - 10° 10° - 0°
Dimensions	
Body	Length mm 255
Plate	Length mm 300 Width mm 37 Height mm 75
Packaging	Box in 1's
Weight (box included)	Kg 2,20
Supplied with	6 fixing screws for wood 6 fixing screws for metal

**SERIE
DC**

DC560 CHIUDIPIORTA AEREI DOOR CLOSERS



DADC560	DC560	DC560
24	FORZA EN 2-3-4 Regolabile tramite molla	POWER EN 2-3-4 Adjustable by springs
HS	BRACCIO A a slitta con fermo	ARM Sliding arm hold open
NA	FINITURE Verniciato argento	FINISHES Silver coating
NE	Verniciato nero	Black coating
	CONFEZIONI Scatola da 1 pz	PACKAGING Boxed in 1's

CARATTERISTICHE TECNICHE

Forza regolabile	EN 2-3-4
Massima larghezza porta	EN 2 mm 850 EN 3 mm 950 EN 4 mm 1100
Peso porta	EN 2 Kg 25 ÷ 40 EN 3 Kg 40 ÷ 60 EN 4 Kg 60 ÷ 80
Esecuzione per porta	DIN destro DIN sinistro
Velocità di chiusura e colpo finale regolabili da 2 valvole indipendenti	120° - 10° 10° - 0°
Dimensioni	Lunghezza mm 210 Larghezza mm 32 Altezza mm 53
Confezione	Scatola da 1 pz
Peso (inclusa confezione)	Kg 1,80
Fornito con	6 viti di fissaggio per legno 6 viti di fissaggio per metallo

TECHNICAL FEATURES

Adjustable closing powe	EN 2-3-4
Maximum door width	EN 2 mm 850 EN 3 mm 950 EN 4 mm 1100
Door weight	EN 2 Kg 25 ÷ 40 EN 3 Kg 40 ÷ 60 EN 4 Kg 60 ÷ 80
Non - handed	DIN right DIN left
Adjustable closing and final latch speed by means of 2 independent valves	120° - 10° 10° - 0°
Dimensions	Length mm 210 Width mm 32 Height mm 53
Packaging	Box in 1's
Weight (box included)	Kg 1,80
Supplied with	6 fixing screws for wood 6 fixing screws for metal

ACCESSORI CHIUDIPIORTA AEREI DOOR CLOSERS ACCESSORIES

**SERIE
 DC**



DADA110ARST

Braccio standard

Per Art. 110-150-160

Standard arm

For Art. 110-150-160



DADA310ARST

Per Art. 210-310

For Art. 210-310

NA

FINITURE

Verniciato argento

NE

Verniciato nero

FINISHES

Silver coating

Black coating



DADA110ARHO

Braccio con fermo

Per Art. 110-150-160

Hold open arm

For Art. 110-150-160



DADA310ARHO

Per Art. 210-310

For Art. 210-310

NA

FINITURE

Verniciato argento

NE

Verniciato nero

FINISHES

Silver coating

Black coating



DADA310ARHS

Braccio a slitta con fermo

Per Art. 110-150-160-210-310

Sliding arm hold open

For Art. 110-150-160-210-310

NA

FINITURE

Verniciato argento

NE

Verniciato nero

FINISHES

Silver coating

Black coating

	BRACCIO STANDARD STANDARD ARM		BRACCIO CON FERMO HOLD OPEN ARM		BRACCIO A SLITTA CON FERMO SLIDING ARM HOLD OPEN
	DADA110ARST	DADA310ARST	DADA110ARHO	DADA310ARHO	DADA310ARHS
DC110	✓		✓		✓
DC150	✓		✓		✓
DC160	✓		✓		✓
DC210		✓		✓	✓
DC310		✓		✓	✓

SERIE
DC

ACCESSORI CHIUDIPIORTA AEREI DOOR CLOSERS ACCESSORIES



DADA110COST

Copertura standard

Metallo per Art. 110

Standard cover

Steel for Art. 110



DADA210COST

Polymera per Art. 210

Polymer for Art. 210



DADA310COST

Polymera per Art. 310

NA

NE

FINITURE

Verniciato argento

Verniciato nero

FINISHES

Silver coating

Black coating



DADA110PLGL

Adattatori porta in vetro

Per DC110

Glass door adapters

For DC110

DADA150PLGL

Per DC150

For DC150

DADA210PLGL

Per DC210

For DC210

DADA310PLGL

Per DC310

For DC310

NA

FINITURE

Verniciato argento

FINISHES

Silver coating

C

ACCESSORI

Con guarnizione inclusa

ACCESSORIES

With seal included

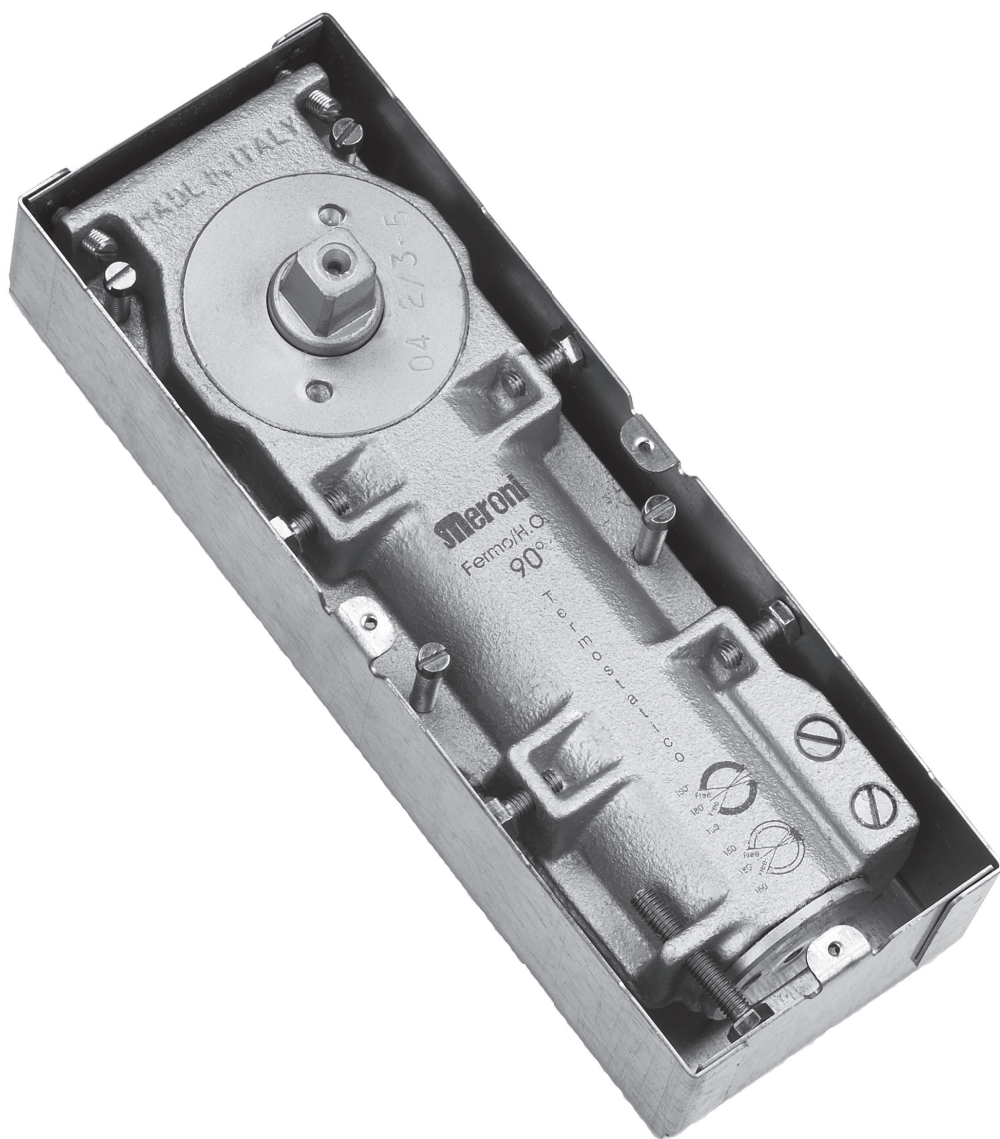

GUARDIAN

**SERIE
FS**

FS880 CHIUDIORTA A PAVIMENTO FLOOR SPRINGS



DAFS880	FS880	FS880
	FORZA	POWER
	Fissa	Size
	FERMO	HOLD OPEN
90	Fermo 90°	Hold open 90°
	FINITURE	FINISHES
2B	Inox satinato	Matt inox
2L	Inox cromo lucido	Chrome polish inox
	ACCESSORI IN DOTAZIONE	INCLUDED ACCESSORIES
	1 piastra + accessori fissaggio	1 plate + fixing accessories
	CONFEZIONI	PACKAGING
	Scatola da 1 pz	Boxed in 1's

CARATTERISTICHE TECNICHE

TECHNICAL FEATURES

Forza fissa		Power size	
Massima larghezza porta	750 - 1000 mm	Maximum door width	750 - 1000 mm
Peso porta	Max 100 Kg	Door weight	Max 100 Kg
Spessore porta	8 - 13 mm	Door thickness	8 - 13 mm
Temperatura d'esercizio	-20°C / +50°C	Operating temperature	-20°C / +50°C
Esecuzione per porta battente	DIN destro - DIN sinistro	Non - Handed	DIN right - DIN left
Esecuzione per porta a ventola	Si	Double action door	Yes
Velocità di chiusura regolabile	150° - 10°	Adjustable closing speed	150° - 10°
Velocità colpo finale regolabile	10° - 0°	Adjustable braking speed	10° - 0°
Angolo di apertura	Max 150°	Angle of opening	Max 150°
Angolo di fermo porta	90° Versione senza fermo su richiesta	Hold open	90° Non hold open version on request
Finiture standard cover	Acciaio satinato Acciaio lucido	Cover standard finishes	Satin steel Polish steel
Dimensioni	Lunghezza mm 186 Larghezza mm 68 Altezza mm 36	Dimensions	Length mm 186 Width mm 68 Height mm 36
Confezione	Scatola da 1 pz	Packaging	Box in 1's
Peso	Kg 3,70	Weight	Kg 3,70

ACCESSORI CHIUDIORTA A PAVIMENTO FLOOR SPRINGS ACCESSORIES

**SERIE
 FS**



DAHG880	Cerniera per alto	<i>Top patch</i>
	FINITURE	FINISHES
2B	Inox satinato	<i>Matt inox</i>
2L	Inox cromo lucido	<i>Chrome polish inox</i>
	CONFEZIONI	PACKAGING
	Scatola da 1 pz	<i>Boxed in 1's</i>

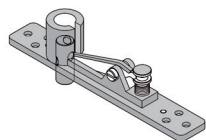

DAPF880	Perno a scomparsa per cerniera per muro legno e alluminio	<i>Concealed pivot for hinge for wall, wood and aluminium</i>
R	Perno regolabile per cerniera per muro legno e alluminio	<i>Adjustable concealed pivot for hinge for wall, wood and aluminium</i>
	FINITURE	FINISHES
2B	Inox satinato	<i>Matt inox</i>
2L	Inox cromo lucido	<i>Chrome polish inox</i>

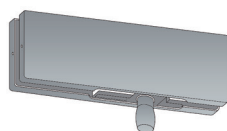

DAHG880	Cerniera superiore per alto	<i>Overhead top patch</i>
	APPLICAZIONE	APPLICATION
O	Per vetro/vetro	<i>For glass/glass</i>
OL	Angolare per vetro/vetro/vetro	<i>Angular patch for glass/glass/glass</i>
	FINITURE	FINISHES
2B	Inox satinato	<i>Matt inox</i>
2L	Inox cromo lucido	<i>Chrome polish inox</i>

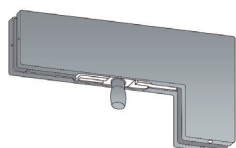

SERIE
FS

FS100 CHIUDIPIORTA A PAVIMENTO FLOOR SPRINGS



DAFS100	FS100	FS100
02	FORZA Fissa EN 2	POWER Size EN 2
03	Fissa EN 3	Size EN 3
SF	FERMO Senza fermo	HOLD OPEN Without hold open
90	Fermo 90°	Hold open 90°
15	Fermo 105°	Hold open 105°
NA	FINITURE Verniciato argento	FINISHES Silver coating
	ACCESSORI 1 piastra inox AISI 304	ACCESSORIES 1 stainless plate AISI 304
	CONFEZIONI Scatola da 1 pz	PACKAGING Boxed in 1's

CARATTERISTICHE TECNICHE

Massima larghezza porta	EN 2 mm 850 ÷ 900 EN 3 mm 900 ÷ 1050
Peso porta	EN 2 Kg 90 EN 3 Kg 120
Esecuzione porta battente esecuzione porta vento	DIN destro DIN sinistro
Velocità di chiusura e colpo finale regolabili da 2 valvole indipendenti	150° - 15° 15° - 0°
Senza fermo Fermo costante	150°/15° - 15°/0° a 90° - a 105°
Perno	Fisso
Dimensioni	Lunghezza mm 245 Larghezza mm 83 Altezza mm 53
Peso	Kg 3,70

TECHNICAL FEATURES

Maximum door width	EN 2 mm 850 ÷ 900 EN 3 mm 900 ÷ 1050
Door weight	EN 2 Kg 90 EN 3 Kg 120
Non - handed Four double action door	DIN right DIN left
Adjustable closing and final latch speed by means of 2 independent valves	150° - 15° 15° - 0°
Without hold open Hold open	150°/15° - 15°/0° to 90° - to 105°
Spindle	Fixed
Dimensions	Length 9 41/64" Width 3 17/64" Height 2 3/32"
Weight	Kg 3,70



FS200 CHIUDIORTA A PAVIMENTO FLOOR SPRINGS

**SERIE
 FS**

DAFS200	FS200	FS200
	FORZA	POWER
02	Fissa EN 2	Size EN 2
03	Fissa EN 3	Size EN 3
04	Fissa EN 4	Size EN 4
05	Fissa EN 5	Size EN 5
	FERMO	HOLD OPEN
SF	Senza fermo	Without hold open
90	Fermo 90°	Hold open 90°
15	Fermo 105°	Hold open 105°
	FINITURE	FINISHES
NA	Verniciato argento	Silver coating
	ACCESSORI	ACCESSORIES
	1 piastra inox AISI 304	1 stainless plate AISI 304
	CONFEZIONI	PACKAGING
	Scatola da 1 pz	Boxed in 1's

CARATTERISTICHE TECNICHE

Massima larghezza porta	EN 2 mm 700 ÷ 900 EN 3 mm 900 ÷ 1050 EN 4 mm 1050 ÷ 1150 EN 5 mm 1150 ÷ 1300
Peso porta	EN 2 Kg 90 EN 3 Kg 120 EN 4 Kg 170 EN 5 Kg 200
Esecuzione porta battente esecuzione porta vento	DIN destro DIN sinistro
Velocità di chiusura e colpo finale regolabili da 2 valvole indipendenti	175° - 15° 15° - 0°
Senza fermo Fermo costante	175°/15° - 15°/0° a 90° - a 105°
Perno	Intercambiabile
Dimensioni	Lunghezza mm 290 Larghezza mm 86 Altezza mm 58
Peso	Kg 4,73

TECHNICAL FEATURES

Maximum door width	EN 2 mm 700 ÷ 900 EN 3 mm 900 ÷ 1050 EN 4 mm 1050 ÷ 1150 EN 5 mm 1150 ÷ 1300
Door weight	EN 2 Kg 90 EN 3 Kg 120 EN 4 Kg 170 EN 5 Kg 200
Non - handed Four double action door	DIN right DIN left
Adjustable closing and final latch speed by means of 2 independent valves	175° - 15° 15° - 0°
Whithout hold open Hold open	170°/15° - 15°/0° to 90° - to 105°
Spindle	Interchangeable
Dimensions	Length Width 3 25/64" Height 2 9/32"
Weight	Kg 4,73

**SERIE
FS**

FS300 CHIUDIORTA A PAVIMENTO FLOOR SPRINGS



DAFS300	FS300	FS300
	FORZA	POWER
02	Fissa EN 2	Size EN 2
03	Fissa EN 3	Size EN 3
04	Fissa EN 4	Size EN 4
	FERMO	HOLD OPEN
SF	Senza fermo	Without hold open
90	Fermo 90°	Hold open 90°
15	Fermo 105°	Hold open 105°
	FINITURE	FINISHES
NA	Verniciato argento	Silver coating
	ACCESSORI	ACCESSORIES
	1 piastra inox AISI 304	1 stainless plate AISI 304
	CONFEZIONI	PACKAGING
	Scatola da 1 pz	Boxed in 1's

CARATTERISTICHE TECNICHE

Massima larghezza porta	EN 2 mm 700 ÷ 900 EN 3 mm 900 ÷ 1050 EN 4 mm 1050 ÷ 1150
Peso porta	EN 2 Kg 90 EN 3 Kg 120 EN 4 Kg 170
Esecuzione porta battente esecuzione porta vento	DIN destro DIN sinistro
Velocità di chiusura e colpo finale regolabili da 2 valvole indipendenti	175° - 15° 15° - 0°
Senza fermo Fermo costante	175°/15° - 15°/0° a 90° - a 105°
Perno	Fisso
Dimensioni	Lunghezza mm 273 Larghezza mm 122 Altezza mm 65
Peso	Kg 6,20

TECHNICAL FEATURES

Maximum door width	EN 2 mm 700 ÷ 900 EN 3 mm 900 ÷ 1050 EN 4 mm 1050 ÷ 1150
Door weight	EN 2 Kg 90 EN 3 Kg 120 EN 4 Kg 170
Non - handed Four double action door	DIN right DIN left
Adjustable closing and final latch speed by means of 2 independent valves	175° - 15° 15° - 0°
Whithout hold open Hold open	170°/15° - 15°/0° to 90° - to 105°
Spindle	Fixed
Dimensions	Length 10 3/4" Width 4 51/64" Height 2 9/16"
Weight	Kg 6,20

ACCESSORI CHIUDIORTA A PAVIMENTO FLOOR SPRINGS ACCESSORIES

SERIE
FS



DAFA100ARBR

Braccio inferiore destro
in ottone

Bottom brass hinge
for right opening doors

FINITURE

Grezzo
Nichelato

FINISHES

Unfinished
Nickel plated

N



DAFA100ARBL

Braccio inferiore sinistro
in ottone

Bottom brass hinge
for left opening doors

FINITURE

Grezzo
Nichelato

FINISHES

Unfinished
Nickel plated

N



DAFA100ARTRL

Braccio superiore per porte
destre e sinistre a battente
in ottone

Top brass hinge
for single leaf doors

FINITURE

Grezzo
Nichelato

FINISHES

Unfinished
Nickel plated

N



DAFA100ARBSD

Braccio inferiore per porte
a doppia azione in ottone

Bottom brass hinge
for swinging doors

FINITURE

Grezzo
Nichelato

FINISHES

Unfinished
Nickel plated

N



DAFA100ARTSD

Braccio superiore per porte
a doppia azione in alluminio

Top aluminium hinge
for swinging doors

FINITURE

Grezzo
Nichelato

FINISHES

Unfinished
Nickel plated

N

info e preventivi
<http://www.bellittiserrature.it/contact.asp>



CILINDRO PROFILO EUROPEO
EUROPEAN PROFILE CYLINDER

info e preventivi
<http://www.bellittiserrature.it/contact.asp>



HN DOPPIO CILINDRO DOUBLE CYLINDER

**SERIE
 EP**

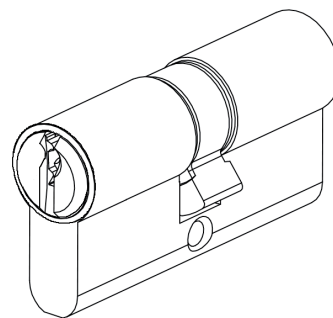
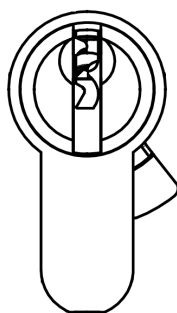
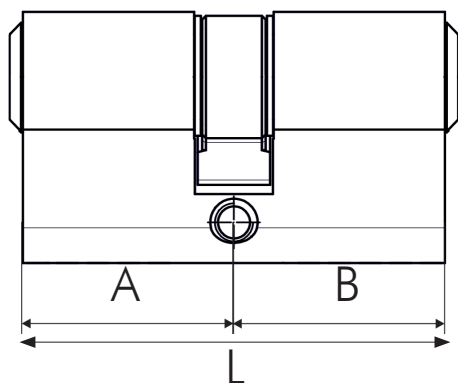

Finitura nichel

Nickel finishes

HN10B30NOCA003I
HN10B35NOCA003I
HN10B40NOCA003I
HN10B45NOCA003I
HN10B50NOCA003I
HN10B55NOCA003I
HN10B60NOCA003I
HN22B22NOCA003I
HN27B27NOCA003I
HN30B30NOCA003I
HN30B35NOCA003I
HN30B40NOCA003I
HN30B45NOCA003I
HN30B50NOCA003I
HN30B55NOCA003I
HN30B60NOCA003I
HN35B35NOCA003I
HN35B40NOCA003I
HN35B45NOCA003I
HN35B50NOCA003I
HN35B55NOCA003I
HN35B60NOCA003I
HN40B40NOCA003I
HN40B45NOCA003I
HN40B50NOCA003I
HN40B55NOCA003I
HN40B60NOCA003I
HN45B45NOCA003I
HN45B50NOCA003I
HN45B55NOCA003I
HN50B50NOCA003I

Mezzo cilindro EP 10x30
 Mezzo cilindro EP 10x35
 Mezzo cilindro EP 10x40
 Mezzo cilindro EP 10x45
 Mezzo cilindro EP 10x50
 Mezzo cilindro EP 10x55
 Mezzo cilindro EP 10x60

Half cylinder EP 10x30
 Half cylinder EP 10x35
 Half cylinder EP 10x40
 Half cylinder EP 10x45
 Half cylinder EP 10x50
 Half cylinder EP 10x55
 Half cylinder EP 10x60

L	A	B
40	10	30
45	10	35
50	10	40
55	10	45
60	10	50
65	10	55
70	10	60
44	22	22
54	27	27
60	30	30
65	30	35
70	30	40
75	30	45
80	30	50
85	30	55
90	30	60
70	35	35
75	35	40
80	35	45
85	35	50
90	35	55
95	35	60
80	40	40
85	40	45
90	40	50
95	40	55
100	40	60
90	45	45
95	45	50
100	45	55
100	50	50



Extra

mezzo cilindro doppio cilindro
 half cylinder double cylinder

KA	extra € 1,15	extra € 2,30
MK	extra € 6,40	extra € 12,80
GMK	extra € 7,90	extra € 15,80
GGMK	extra € 9,90	extra € 16,60

**SERIE
EP**

HN DOPPIO CILINDRO DOUBLE CYLINDER

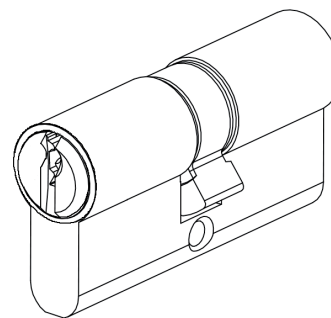
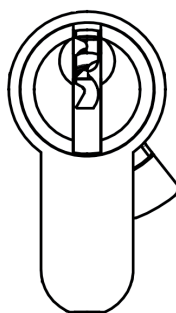
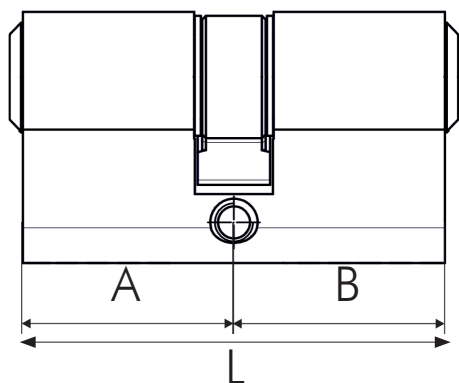

Finitura ottone

Brass finishes

HN10B30OOCA003N	Mezzo cilindro EP 10x30
HN10B35OOCA003N	Mezzo cilindro EP 10x35
HN10B40OOCA003N	Mezzo cilindro EP 10x40
HN10B45OOCA003N	Mezzo cilindro EP 10x45
HN10B50OOCA003N	Mezzo cilindro EP 10x50
HN10B55OOCA003N	Mezzo cilindro EP 10x55
HN10B60OOCA003N	Mezzo cilindro EP 10x60
HN22B22OOCA003N	Doppio cilindro EP 22x22
HN27B27OOCA003N	Doppio cilindro EP 27x27
HN30B30OOCA003N	Doppio cilindro EP 30x30
HN30B35OOCA003N	Doppio cilindro EP 30x35
HN30B40OOCA003N	Doppio cilindro EP 30x40
HN30B45OOCA003N	Doppio cilindro EP 30x45
HN30B50OOCA003N	Doppio cilindro EP 30x50
HN30B55OOCA003N	Doppio cilindro EP 30x55
HN30B60OOCA003N	Doppio cilindro EP 30x60
HN35B35OOCA003N	Doppio cilindro EP 35x35
HN35B40OOCA003N	Doppio cilindro EP 35x40
HN35B45OOCA003N	Doppio cilindro EP 35x45
HN35B50OOCA003N	Doppio cilindro EP 35x50
HN35B55OOCA003N	Doppio cilindro EP 35x55
HN35B60OOCA003N	Doppio cilindro EP 35x60
HN40B40OOCA003N	Doppio cilindro EP 40x40
HN40B45OOCA003N	Doppio cilindro EP 40x45
HN40B50OOCA003N	Doppio cilindro EP 40x50
HN40B55OOCA003N	Doppio cilindro EP 40x55
HN40B60OOCA003N	Doppio cilindro EP 40x60
HN45B45OOCA003N	Doppio cilindro EP 45x45
HN45B50OOCA003N	Doppio cilindro EP 45x50
HN45B55OOCA003N	Doppio cilindro EP 45x55
HN50B50OOCA003N	Doppio cilindro EP 50x50

Mezzo cilindro EP 10x30
Mezzo cilindro EP 10x35
Mezzo cilindro EP 10x40
Mezzo cilindro EP 10x45
Mezzo cilindro EP 10x50
Mezzo cilindro EP 10x55
Mezzo cilindro EP 10x60
Doppio cilindro EP 22x22
Doppio cilindro EP 27x27
Doppio cilindro EP 30x30
Doppio cilindro EP 30x35
Doppio cilindro EP 30x40
Doppio cilindro EP 30x45
Doppio cilindro EP 30x50
Doppio cilindro EP 30x55
Doppio cilindro EP 30x60
Doppio cilindro EP 35x35
Doppio cilindro EP 35x40
Doppio cilindro EP 35x45
Doppio cilindro EP 35x50
Doppio cilindro EP 35x55
Doppio cilindro EP 35x60
Doppio cilindro EP 40x40
Doppio cilindro EP 40x45
Doppio cilindro EP 40x50
Doppio cilindro EP 40x55
Doppio cilindro EP 40x60
Doppio cilindro EP 45x45
Doppio cilindro EP 45x50
Doppio cilindro EP 45x55
Doppio cilindro EP 50x50

Half cylinder EP 10x30
Half cylinder EP 10x35
Half cylinder EP 10x40
Half cylinder EP 10x45
Half cylinder EP 10x50
Half cylinder EP 10x55
Half cylinder EP 10x60
Double cylinder EP 22x22
Double cylinder EP 27x27
Double cylinder EP 30x30
Double cylinder EP 30x35
Double cylinder EP 30x40
Double cylinder EP 30x45
Double cylinder EP 30x50
Double cylinder EP 30x55
Double cylinder EP 30x60
Double cylinder EP 35x35
Double cylinder EP 35x40
Double cylinder EP 35x45
Double cylinder EP 35x50
Double cylinder EP 35x55
Double cylinder EP 35x60
Double cylinder EP 40x40
Double cylinder EP 40x45
Double cylinder EP 40x50
Double cylinder EP 40x55
Double cylinder EP 40x60
Double cylinder EP 45x45
Double cylinder EP 45x50
Double cylinder EP 45x55
Double cylinder EP 50x50

L	A	B
40	10	30
45	10	35
50	10	40
55	10	45
60	10	50
65	10	55
70	10	60
44	22	22
54	27	27
60	30	30
65	30	35
70	30	40
75	30	45
80	30	50
85	30	55
90	30	60
70	35	35
75	35	40
80	35	45
85	35	50
90	35	55
95	35	60
80	40	40
85	40	45
90	40	50
95	40	55
100	40	60
90	45	45
95	45	50
100	45	55
100	50	50



Extra

mezzo cilindro doppio cilindro
half cylinder double cylinder

KA	extra € 1,15	extra € 2,30
MK	extra € 6,40	extra € 12,80
GMK	extra € 7,90	extra € 15,80
GGMK	extra € 9,90	extra € 16,60



HP DOPPIO CILINDRO CON POMOLO DOUBLE CYLINDER WITH ROUND KNOB

**SERIE
 EP**

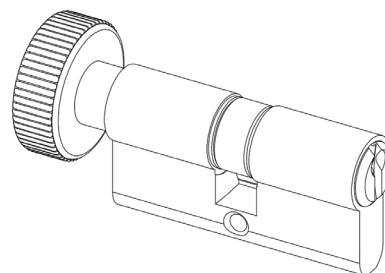
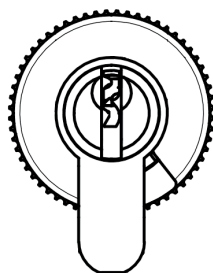
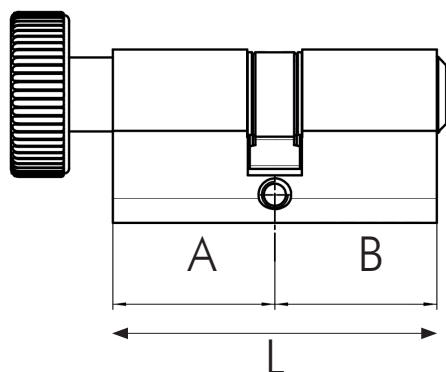

Finitura nichel

Nickel finishes

HP30B30N1OCA003I
HP30B40N1OCA003I
HP30B45N1OCA003I
HP30B55N1OCA003I
HP35B35N1OCA003I
HP35B45N1OCA003I
HP40B30N1OCA003I
HP40B40N1OCA003I
HP40B45N1OCA003I
HP40B50N1OCA003I
HP45B35N1OCA003I
HP45B45N1OCA003I
HP45B50N1OCA003I
HP50B40N1OCA003I
HP55B45N1OCA003I

Doppio cilindro EP 30x30
Doppio cilindro EP 30x40
Doppio cilindro EP 30x45
Doppio cilindro EP 30x55
Doppio cilindro EP 35x35
Doppio cilindro EP 35x45
Doppio cilindro EP 40x30
Doppio cilindro EP 40x40
Doppio cilindro EP 40x45
Doppio cilindro EP 40x50
Doppio cilindro EP 45x35
Doppio cilindro EP 45x45
Doppio cilindro EP 45x50
Doppio cilindro EP 50x40
Doppio cilindro EP 55x45

Double cylinder EP 30x30
Double cylinder EP 30x40
Double cylinder EP 30x45
Double cylinder EP 30x55
Double cylinder EP 35x35
Double cylinder EP 34x45
Double cylinder EP 40x30
Double cylinder EP 40x40
Double cylinder EP 40x45
Double cylinder EP 40x50
Double cylinder EP 45x35
Double cylinder EP 45x45
Double cylinder EP 45x50
Double cylinder EP 50x40
Double cylinder EP 55x45

L	A	B
60	30	30
70	30	40
75	30	45
85	30	55
70	35	35
80	35	45
70	40	30
80	40	40
85	40	45
90	40	50
80	45	35
90	45	45
95	45	50
90	50	40
100	55	45

Finitura ottone

Brass finishes

HP30B30O1OCA003N
HP30B40O1OCA003N
HP30B45O1OCA003N
HP30B55O1OCA003N
HP35B35O1OCA003N
HP35B45O1OCA003N
HP40B30O1OCA003N
HP40B40O1OCA003N
HP40B45O1OCA003N
HP40B50O1OCA003N
HP45B35O1OCA003N
HP45B45O1OCA003N
HP45B50O1OCA003N
HP50B40O1OCA003N
HP55B45O1OCA003N

Doppio cilindro EP 30x30
Doppio cilindro EP 30x40
Doppio cilindro EP 30x45
Doppio cilindro EP 30x55
Doppio cilindro EP 35x35
Doppio cilindro EP 35x45
Doppio cilindro EP 40x30
Doppio cilindro EP 40x40
Doppio cilindro EP 40x45
Doppio cilindro EP 40x50
Doppio cilindro EP 45x35
Doppio cilindro EP 45x45
Doppio cilindro EP 45x50
Doppio cilindro EP 50x40
Doppio cilindro EP 55x45

Double cylinder EP 30x30
Double cylinder EP 30x40
Double cylinder EP 30x45
Double cylinder EP 30x55
Double cylinder EP 35x35
Double cylinder EP 34x45
Double cylinder EP 40x30
Double cylinder EP 40x40
Double cylinder EP 40x45
Double cylinder EP 40x50
Double cylinder EP 45x35
Double cylinder EP 45x45
Double cylinder EP 45x50
Double cylinder EP 50x40
Double cylinder EP 55x45

L	A	B
60	30	30
70	30	40
75	30	45
85	30	55
70	35	35
80	35	45
70	40	30
80	40	40
85	40	45
90	40	50
80	45	35
90	45	45
95	45	50
90	50	40
100	55	45

Extra



KA	extra € 1,15
MK	extra € 6,40
GMK	extra € 7,90
GGMK	extra € 9,30



ELETTRONICA PER MOBILE
FURNITURES ELECTRONICS

info e preventivi
<http://www.bellittiserrature.it/contact.asp>

SERRATURE ELETTRONICHE PER MOBILE ELECTRONIC FURNITURE LOCKS

SERIE
E

SERIE
E



E251U18GH2

Kit Sicura

1 Sicura sp18-20 mm unica dx/sx
 1 tastiera a 11 tasti, cromo opaco /
 grigio 4

FINITURE POMOLO

Grigio - Nero
 Nero - Grigio 8

ACCESSORI IN DOTAZIONE

1 batteria 9V
 Levetta piana, fermantina e viti
 Senza batteria

Sicura Kit

1 Sicura thickness 18-20 mm left/right
 1 keypad with 11 keys, matt chrome
 / grey 4

KNOB FINISHES

Grey - Black
 Black - Grey 8

INCLUDED ACCESSORIES

1 battery 9 volts
 Cam, striking plate, screws
 Without battery

NA/NE
 NE/G8

BR
 1
 S

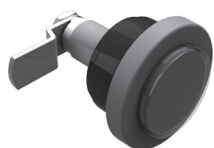

K-EASY

Kit pomolo Mifare

1 pomolo Mifare
 rotazione oraria e antioraria
 1 levetta

FINITURE POMOLO

Base nera RAL 790-M
 Ghiera grigia RAL 110-M

Mifare knob kit

1 Mifare knob
 clock/anti-clockwise rotation
 1 cam

KNOB FINISHES

Black base RAL 790-M
 Grey ring RAL 110-M



K-EASY-CODE

Pomolo a combinazione

1 pomolo a combinazione
 rotazione oraria e antioraria
 1 levetta

FINITURE POMOLO

Base nera RAL 790-M
 Ghiera grigia RAL 110-M

Combination knob

1 combination knob
 clock/anticlockwise rotation
 1 cam

KNOB FINISHES

Black base RAL 790-M
 Grey ring RAL 110-M



E4033GNASCB

Kit Multipla

Serratura elettronica per cassetiera
 completa di terminale di lettura,
 viti di fissaggio
 senza schede e batterie

Kit Multipla

Electronic lock for drawers
 with reader terminal,
 fixing screws
 without cards and batteries



E4000ALES

Alimentatore esterno per Multipla
 senza batterie

External power supply for Multipla
 without batteries



E4000CARD

Carta trasponder per Multipla
 neutra e non programmata

Transponder card for Multipla
 blank and not programmed

info e preventivi
<http://www.bellittiserrature.it/contact.asp>



SERRATURE PER MOBILE
FURNITURE LOCKS

INDICE CORRISPONDENZA CODICI CODES CORRESPONDENT INDEX

VECCHIO OLD	NUOVO NEW	PAGINA PAGE
1 S A	2A31M	169
1 S A UNIKO	2A31M	169
1 S C	2A30M	166
1 S C UNIKO	2A30M	166
3 S A	2A31R	170
3 S A UNIKO	2A31R	170
3 S C	2A30R	167
3 S C UNIKO	2A30R	167
18 C	2B12	201
28	M28	152
51	M59B	154
53	M32	152
79	O1679	298
80	O1680	298
81	O1681	298
82	2BH82	300
82/P10-P11	2BH82P10-P11	301
82/PU	2BG82	301
86	O1686	298
91	O1691	299
92	O1692	299
106	ODIS106	296
145	M64	155
145 C	2B64	210
175 O	2A33	172
175 V	2A34	174
200	O944	306
201	O944	306
202	O944	306
203	O944	306
214 N	M98A	160
215 N	M98	160
221 C	2B33	204
222 C	2A85A	192
222 N	M85A	157
223 C	2A85	192
223 N	M85	157
224 C	2A93A	194
224/N	M93A	159
225 C	2A93	194
225 N	M93	159
231	2B11	200
256	2C256	219
257	2A57	178

VECCHIO OLD	NUOVO NEW	PAGINA PAGE
270	2C24	217
281	OASTAC837	269
282	OTUBO837	269
328	OGRA328	284
363	O858	282
390	OGRA390	291
398	OGRA398	275
398 R	OGRA398R	275
399	OGRA399	276
399 R	OGRA399R	276
401	2AGHIE17	296
402 A	2B43	208
402 C	2B41	206
422 C	2A84A	190
422 N	M84A	156
423 C	2A84	190
423 N	M84	156
590	OGRA590	284
605 (zama/die cast)	O876	279
605 (polimero/polymer)	OCAVAR605	279
606	OGRA606	278
609 B	OGRA609B	280
609 BR	OGRA609BR	280
609 T	OGRA609T	280
609 TR	OGRA609TR	281
611 (zama/die cast)	OCAVA611	281
611 (polimero/polymer)	OCAVA611	281
612 (zama/die cast)	OCAVA612	281
612 (polimero/polymer)	OCAVA612	281



MPE SERRATURA DA INFILARE MORTISE LOCK

SERIE
M

MPE	Perfect mm 15 ÷ 30 senza chiave	<i>Perfect mm 15 ÷ 30 without key</i>
	BORDO (acciaio ottonato)	FOREND (brass plated steel)
T	Quadro Tondo	Square Round
	FUNZIONAMENTO	OPERATION
	Rotazione 360°	Rotating 360°
	CHIAVE	KEY
CC	Senza chiave Art.699 nichelata	Without key Art.699 nickel plated
	ENTRATA	BACKSET
15	mm 15	mm 15
20	mm 20	mm 20
25	mm 25	mm 25
30	mm 30	mm 30
35	mm 35	mm 35
40	mm 40	mm 40
50	mm 50	mm 50
60	mm 60	mm 60
70	mm 70	mm 70
80	mm 80	mm 80
	APPLICAZIONE	APPLICATION
S	Antina destra e cassetto Antina sinistra	Right hand door and drawer Left hand door
	CONFEZIONE	PACKAGING
I	Commercio 20 pz Industria 100 pz	Boxed in 20's Bulk in 100's

SERIE
M

SERIE
M

M28 SERRATURA PER COFANETTI CASKETS LOCK

ex 28



M28	28 senza chiave	28 without key
	SCATOLA (acciaio)	BODY (steel)
F	Ferro grezzo	Rough
OT	Ottonato	Brass plated
	FUNZIONAMENTO	OPERATION
	Rotazione 360°	Rotating 360°
	ENTRATA	BACKSET
40	mm 40	mm 40
50	mm 50	mm 50
	CHIAVE	KEY
Q	Senza chiave con controbordo	Without key with striking plate
604OT	Art.604/OT con controbordo	Art.604/OT with striking plate
	CONFEZIONE	PACKAGING
	Commercio 20 pz	Boxed in 20's
I	Industria 100 pz	Bulk in 100's

M32 SERRATURA DA INFILARE MOTISE LOCK

ex 53



M32	53 mm 15 ÷ 30 senza chiave	53 mm 15 ÷ 30 without key
	BORDO (acciaio)	FOREND (steel)
	Quadro	Square
T	Tondo	Round
	FUNZIONAMENTO	OPERATION
	Rotazione 360°	Rotating 360°
	FINITURE	FINISHES
FE	Ferro grezzo	Rough steel
	Ottonato	Brass plated
	ENTRATA	BACKSET
15	mm 15	mm 15
20	mm 20	mm 20
25	mm 25	mm 25
30	mm 30	mm 30
35	mm 35	mm 35
40	mm 40	mm 40
45	mm 45	mm 45
50	mm 50	mm 50
	CHIAVE	KEY
Q	Senza chiave	Without key
079N	Art.79 nichelato	Art.79 nickel plated
	CONFEZIONE	PACKAGING
	Commercio 20 pz	Boxed in 20's
I	Industria 100 pz	Bulk in 100's



M42 SERRATURA DA APPLICARE SCREW-ON LOCK

SERIE
M

SERIE
M

M42	42 mm 15 ÷ 30 senza chiave	42 mm 15 ÷ 30 without key
	SCATOLA (acciaio)	BODY (steel)
	Standard	Standard
R	Refilata	Refilated
	FINITURE	FINISHES
	Grezzo	Rough
N	Nichelato	Nickel plated
OT	Ottonato	Brass plated
BZ	Bronzato	Bronze plated
	FUNZIONAMENTO	OPERATION
	Rotazione 360°	Rotating 360°
	CHIAVE	KEY
	Senza chiave	Without key
CC	Art.699 nichelato	Art.699 nickel plated
	ENTRATA	BACKSET
15	mm 15	mm 15
20	mm 20	mm 20
25	mm 25	mm 25
30	mm 30	mm 30
35	mm 35	mm 35
40	mm 40	mm 40
45	mm 45	mm 45
50	mm 50	mm 50
60	mm 60	mm 60
70	mm 70	mm 70
80	mm 80	mm 80
90	mm 90	mm 90
	APPLICAZIONE	APPLICATION
	Antina destra-sinistra e cassetto	Right hand-Left hand door and drawer
	CONFEZIONE	PACKAGING
	Commercio 20 pz	Boxed in 20's
I	Industria 200 pz	Bulk in 200's

SERIE
M

M45 SERRATURA DA APPLICARE SCREW-ON LOCK



M45	45 mm 15 ÷ 20 senza chiave	45 mm 15 ÷ 20 without key
	SCATOLA (zama)	BODY (die cast)
N	Nichelato	Nickel plated
OA	Ottone antico	Antique brass
	FUNZIONAMENTO	OPERATION
	Rotazione 360°	Rotating 360°
	CHIAVE	KEY
	Senza chiave	Without key
	ENTRATA	BACKSET
15	mm 15	mm 15
20	mm 20	mm 20
25	mm 25	mm 25
30	mm 30	mm 30
	APPLICAZIONE	APPLICATIONS
	Antina destra e cassetto	Right hand door and drawer
S	Antina sinistra	Left hand door
	CONFEZIONE	PACKAGING
	Commercio 20 pz	Boxed in 20's
I	Industria 200 pz	Bulk in 200's

M59B SERRATURA DA INFILARE MORTISE LOCK

ex 51



M59B	51 bordo ottonato senza chiave	51 brass plated forend without key
	BORDO	FOREND
OT	Ottonato	Brass plated
TO	Ottone grezzo	Rough brass
	APPLICAZIONE	APPLICATION
	Antina destra	Right hand door
S	Antina sinistra	Left hand door
	CHIAVE	KEY
Q	Senza chiave con controbordo	Without key with striking plate
079N	Art.79 nichelato con controbordo	Art.79 nickel plated with striking plate
	CONFEZIONE	PACKAGING
	Commercio 20 pz	Boxed in 20's
I	Industria 100 pz	Bulk in 100's



M64 SERRATURA A STRINGA PASQUIL LOCK

SERIE
M

ex 145

M64	145 solo serratura	145 only lock
	VERSIONE	TYPE
A	Cava tonda	Round key-way
B	Cava quadra	Square key-way
C	Con canna	With pipe
	SCATOLA (acciaio)	BODY (steel)
	Grezza	Rough
N	Nichelato	Nickel plated
OT	Ottonato	Brass plated
	APPLICAZIONE	APPLICATION
	Antina destra	Right hand door
S	Antina sinistra	Left hand door
	CHIAVE	KEY
Q	Senza chiave	Without key
079N	Art.79 nichelato	Art.79 nickel plated
	CONFEZIONE	PACKAGING
	Commercio 20 pz	Boxed in 20's
I	Industria 100 pz	Bulk in 100's

SERIE
M



M67 SERRATURA DA INCASTRARE BORE-IN LOCK

M67	67 solo serratura	67 lock only
	SCATOLA (acciaio)	BODY (steel)
	FUNZIONAMENTO	OPERATION
	Rotazione 360°	Rotating 360°
	VERSIONE	TYPE
	Standard	Standard
B	Bis (senza alette di fissaggio)	Bis (without external fixing slots)
	CHIAVE	KEY
	Senza chiave	Without key
	ACCESSORI	ACCESSORIES
	Senza accessori	Without accessories
CC	1 art.699 nichelato	1 item 699 nickel plated
	1 placca Art.820	1 plate Art.820
	4 cavallotti Art.827	4 saddles Art.827
	2 contropiastre Art.828	2 striking plates Art.828
	APPLICAZIONE	APPLICATION
	Antina destra	Right hand door
S	Antina sinistra	Left hand door
	CONFEZIONE	PACKAGING
	Commercio 20 pz	Boxed in 20's
I	Industria 150 pz	Bulk in 150's

SERIE
M

M84 SERRATURA DA APPLICARE SCREW-ON LOCK



M84	84 solo serratura	84 only lock
	FISSAGGIO	FIXING
	A vite	Screw-on
A	A pressione	Press-on
	SCATOLA (zama)	BODY (die cast)
N	Nichelato	Nickel plated
OA	Ottone antico	Antique brass
OT	Ottonato	Brass plated
	FUNZIONAMENTO	OPERATION
	Rotazione 360°	Rotating 360°
	CHIAVE	KEY
	Senza chiave	Without key
	APPLICAZIONE	APPLICATION
	Antina destra e sinistra	Right hand and Left hand door
	CONFEZIONE	PACKAGING
	Commercio 20 pz	Boxed in 20's
I	Industria 200 pz	Bulk in 200's

M84 SERRATURA DA APPLICARE SCREW-ON LOCK

ex 422 N/423 N



M84	Solo serratura	Only lock
	FISSAGGIO	FIXING
	423 N a vite	423 N screw-on
A	422 N a pressione	422 N press-on
	SCATOLA (zama)	BODY (die cast)
BZ	Bronzato	Bronze plated
N	Nichelato	Nickel plated
OT	Ottonato	Brass plated
OA	Ottone Antico	Antique brass
NE	Verniciato nero	Enamelled black
	APPLICAZIONE	APPLICATION
9D	Antina destra	Right hand door
9S	Antina sinistra	Left hand door
	CHIAVE	KEY
Q	Senza chiave	Without key
	CONFEZIONE	PACKAGING
	Commercio 20 pz	Boxed in 20's
I	Industria 100 pz	Bulk in 100's



M85 SERRATURA DA APPLICARE SCREW-ON LOCK

SERIE
M

M85	85 solo serratura	85 lock only
	FISSAGGIO	FIXING
	A vite	Screw-on
A	A pressione	Press-on
	SCATOLA (zama)	BODY (die cast)
N	Nichelato	Nickel plated
OA	Ottone Antico	Antique brass
OT	Ottonato	Brass plated
	FUNZIONAMENTO	OPERATION
	Rotazione 360°	Rotating 360°
	CHIAVE	KEY
	Senza chiave	Without key
	ENTRATA	BACKSET
15	mm 15	mm 15
	APPLICAZIONE	APPLICATION
	Antina destra	Right hand door
S	Antina sinistra	Left hand door
	CONFEZIONE	PACKAGING
	Commercio 20 pz	Boxed in 20's
I	Industria 200 pz	Bulk in 200's

SERIE
M



M85 SERRATURA DA APPLICARE SCREW-ON LOCK

ex 222 N/223 N

M85	Solo serratura	Only lock
	FISSAGGIO	FIXING
	223 N a vite	223 N screw-on
A	222 N a pressione	222 N press-on
	SCATOLA (zama)	BODY (die cast)
BZ	Bronzato	Bronze plated
N	Nichelato	Nickel plated
OT	Ottonato	Brass plated
OA	Ottone Antico	Antique brass
NE	Verniciato nero	Enamelled black
	CATENACCIO	BOLT
	Standard	Standard
CF	A filo	Cutted
48	mm 48	mm 48
55	mm 55	mm 55
	APPLICAZIONE	APPLICATION
	Antina destra	Right hand door
S	Antina sinistra	Left hand door
	CHIAVE	KEY
	Senza chiave	Without key
Q	Art.79 nichelato	Art.79 nickel plated
079N		
	CONFEZIONE	PACKAGING
	Commercio 20 pz	Boxed in 20's
I	Industria 100 pz	Bulk in 100's

SERIE
M

M86R SERRATURA DA APPLICARE SCREW-ON LOCK



M86R	86/R solo serratura	86/R lock only
	FISSAGGIO	FIXING
	A vite	Screw-on
A	A pressione	Press-on
	SCATOLA (zama)	BODY (die cast)
N	Nichelato	Nickel plated
OA	Ottone Antico	Antique brass
OT	Ottonato	Brass plated
	FUNZIONAMENTO	OPERATION
	Rotazione 360°	Rotating 360°
	CHIAVE	KEY
	Senza chiave	Without key
	APPLICAZIONE	APPLICATION
	Antina destra e sinistra	Right hand and Left hand door
	CONFEZIONE	PACKAGING
	Commercio 20 pz	Boxed in 20's
I	Industria 200 pz	Bulk in 200's

M87R SERRATURA DA APPLICARE SCREW-ON LOCK



M87R	87/R mm 15 ÷ 20 solo serratura	87/R mm 15 ÷ 20 lock only
	FISSAGGIO	FIXING
	A vite	Screw-on
A	A pressione	Press-on
	SCATOLA (zama)	BODY (die cast)
N	Nichelato	Nickel plated
OA	Ottone Antico	Antique brass
OT	Ottonato	Brass plated
	FUNZIONAMENTO	OPERATION
	Rotazione 360°	Rotating 360°
	CHIAVE	KEY
	Senza chiave	Without key
	ENTRATA	BACKSET
15	mm 15	mm 15
20	mm 20	mm 20
25	mm 25	mm 25
30	mm 30	mm 30
	APPLICAZIONE	APPLICATION
	Antina destra e sinistra	Right hand and Left hand door
	CONFEZIONE	PACKAGING
	Commercio 20 pz	Boxed in 20's
I	Industria 200 pz	Bulk in 200's



M93 SERRATURA DA APPLICARE SCREW-ON LOCK

SERIE
M

M93	93 solo serratura	93 lock only
	FISSAGGIO A vite	FIXING Screw-on
	SCATOLA (polimero) Marrone Bianco	BODY (polymer) Brown White
B W	FUNZIONAMENTO Rotazione 360°	OPERATION Rotating 360°
	CHIAVE Senza chiave	KEY Without key
	APPLICAZIONE Antina destra e sinistra	APPLICATION Right hand and Left hand door
	CONFEZIONE Commercio 20 pz Industria 200 pz	PACKAGING Boxed in 20's Bulk in 200's

SERIE
M



M93 SERRATURA DA APPLICARE SCREW-ON LOCK

ex 224 N/225 N

M93	Solo serratura	Only lock
	FISSAGGIO 225 N a vite 224 N a pressione	FIXING 225 N screw-on 224 N press-on
A	SCATOLA (polimero) Bianco Marrone Nero	BODY (polymer) White Brown Black
W B NE	FUNZIONAMENTO Rotazione 360°	OPERATION Rotating 360°
	CHIAVE Senza chiave	KEY Without key
Q	CONFEZIONE Commercio 10 pz Industria 100 pz	PACKAGING Boxed in 10's Bulk in 100's

SERIE
M

M98 SERRATURA DA APPLICARE SCREW-ON LOCK



M98	98 solo serratura	98 lock only
	FISSAGGIO A vite	FIXING Screw-on
	SCATOLA (zama) Nichelato	BODY (die cast) Nickel plated
N	Ottonato	Brass plated
OT		
	FUNZIONAMENTO Rotazione 360°	OPERATION Rotating 360°
	CHIAVE Senza chiave	KEY Without key
	APPLICAZIONE Antina destra e sinistra	APPLICATION Right hand and Left hand door
	CONFEZIONE Commercio 20 pz	PACKAGING Boxed in 20's
I	Industria 200 pz	Bulk in 200's

M98 SERRATURA DA APPLICARE SCREW-ON LOCK

ex 214 N/215 N



M98	Solo serratura	Only lock
	FISSAGGIO 215 N a vite	FIXING 215 N screw-on
A	214 N a pressione	214 N press-on
	SCATOLA (zama) Bronzato	BODY (die cast) Bronze plated
BZ	Nichelato	Nickel plated
N	Ottonato	Brass plated
OT	Ottone Antico	Antique brass
OA	Verniciato nero	Enamelled black
NE		
	CATENACCIO A filo	BOLT Cutted
CF	mm 15	mm 15
15	mm 20	mm 20
20	mm 48	mm 48
48	mm 55	mm 55
55		
	APPLICAZIONE Antina destra	APPLICATION Right hand door
9D	Antina sinistra	Left hand door
9S		
	CHIAVE Senza chiave	KEY Without key
Q		
	CONFEZIONE Commercio 20 pz	PACKAGING Boxed in 20's
I	Industria 100 pz	Bulk in 100's

info e preventivi
<http://www.bellittiserrature.it/contact.asp>



CILINDRI A SPINE Ø 16,5
PIN TUMBLER CYLINDERS Ø 16,5



CILINDRI A SPINE Ø 17
PIN TUMBLER CYLINDERS Ø 17

info e preventivi
<http://www.bellittiserrature.it/contact.asp>



2130 SERRATURA DA APPLICARE SCREW-ON LOCK

**SERIE
 21**

2130	2130 cilindro mm 16 ÷ 20	2130 cylinder mm 16 ÷ 20
P	Per pomolino	For knob
B	FUNZIONAMENTO Rotazione 360° (2 uscite chiave) Rotazione 320° (1 uscita chiave)	OPERATION Rotating 360° (2 key pull) Rotating 320° (1 key pull)
B NE W	SCATOLA (polimero) Marrone Nero Bianco	BODY (polymer) Brown Black White
16 20 23 25 30	CILINDRO Ø 16,5 mm 16 mm 20 mm 23,5 mm 25 mm 30	CYLINDER Ø 16,5 mm 16 mm 20 mm 23,5 mm 25 mm 30
6	Sporgente mm 6 (cilindro ribassato)	Extended core mm 6 (rebated cylinder)
N	Cilindro numerato	Numbered cylinder
A X M	CIFRATURA KD chiavi differenti KA chiavi uguali ..x.. KA gruppi di KA MK chiave maestra	KEY-CHANGE KD keyed differently KA keyed alike ..x.. KA KA in groups MK master key
P8	CHIAVE Art.1804 (2 pz) Art.IP/8 per pomolino 1998 (2 pz)	KEY Art.1804 (2 pcs) Art.IP/8 for knob 1998 (2 pcs)
4 14 BT	FINITURA Ottone decapato (US4) Ottone nichelato (US14) Ottone brunito	FINISH Pickled brass (US4) Nickel plated brass (US14) Browned plated brass
P9	CATENACCIO Piano P0 Piegato mm 9	BOLT Flat P0 Bent mm 9
BT	FINITURA CATENACCIO Zincato Brunito	BOLT FINISH Zinc plated Burnished
	ACCESSORI 1 ghiera Art.1716 1 controbordo Art.807	ACCESSORIES 1 ring Art.1716 1 striking plate Art.807
I	CONFEZIONE Commercio 20 pz Industria 200 pz	PACKAGING Boxed in 20's Bulk in 200's

SERIE
2A

2A30M SERRATURA DA APPLICARE SCREW-ON LOCK



ex 1/S C

2A30M	1/S C cilindro mm 20	1/S C cylinder mm 20
	FUNZIONAMENTO	OPERATION
	Rotazione 360° (2 uscite chiave)	Rotating 360° (2 key pull)
B	Rotazione 320° (1 uscita chiave)	Rotating 320° (1 key pull)
	SCATOLA (zama)	BODY (die cast)
N	Nichelato	Nickel plated
OT	Ottonato	Brass plated
NE	Nero	Black
BZ	Bronzato	Bronze plated
	CILINDRO Ø 17	CYLINDER Ø 17
20	mm 20	mm 20
22	mm 22	mm 22
25	mm 25	mm 25
30	mm 30	mm 30
N	Cilindro numerato	Numbered cylinder
	CIFRATURA	KEY-CHANGE
	KD chiavi differenti	KD keyed differently
A	KA chiavi uguali	KA keyed alike
X	...x.. KA gruppi di KA	...x.. KA KA in groups
M	MK chiave maestra	MK master key
	CHIAVE	KEY
	Art.82 nichelato (2 pz)	Art.82 nickel plated (2 pcs)
PUNE	Art.82PU nero per Uniko (2 pz)	Art.82PU nero for Uniko (2 pcs)
PUG8	Art.82PU grigio per Uniko (2 pz)	Art.82PU grey for Uniko (2 pcs)
	FINITURA	FINISH
14	Nichelato (US14)	Nickel plated (US14)
OT	Ottonato	Brass plated
BZ	Bronzato	Bronze plated
NE	Nero	Black
	CATENACCIO	BOLT
	Piano	Flat
P35	Piega mm 3,5	Bent mm 3,5
P7	Piega mm 7,5	Bent mm 7,5
P10	Piega mm 10	Bent mm 10
P12	Piega mm 12	Bent mm 12
P15	Piega mm 15	Bent mm 15
	ACCESSORI	ACCESSORIES
	1 ghiera Art.401	1 ring Art.401
7Z	1 controbordo Art. 807	1 striking plate Art. 807
	CONFEZIONE	PACKAGING
	Commercio 20 pz	Boxed in 20's
I	Industria 100 pz	Bulk in 100's



2A30R SERRATURA DA APPLICARE SCREW-ON LOCK

SERIE
2A

ex 3/S C

2A30R	3/S C cilindro mm 20	3/S C cylinder mm 20
	FUNZIONAMENTO	OPERATION
	Rotazione 360° (2 uscite chiave)	Rotating 360° (2 key pull)
B	Rotazione 320° (1 uscita chiave)	Rotating 320° (1 key pull)
	SCATOLA (polimero)	BODY (polymer)
B	Marrone	Brown
NE	Nero	Black
W	Bianco	White
	CILINDRO Ø 17	CYLINDER Ø 17
20	mm 20	mm 20
	CIFRATURA	KEY-CHANGE
	KD chiavi differenti	KD keyed differently
A	KA chiavi uguali	KA keyed alike
X	...x.. KA gruppi di KA	...x.. KA KA in groups
M	MK chiave maestra	MK master key
	CHIAVE	KEY
	Art.82 nichelato (2 pz)	Art.82 nickel plated (2 pcs)
PUNE	Art.82PU nero per Uniko (2 pz)	Art.82PU black for Uniko (2 pcs)
PUG8	Art.82PU grigio per Uniko (2 pz)	Art.82PU grey for Uniko (2 pcs)
	FINITURA	FINISH
14	Nichelato (US14)	Nickel plated (US14)
GR	Ottone grezzo	Rough brass
BZ	Bronzato	Bronze plated
NE	Nero	Black
	CATENACCIO	BOLT
	Piano	Flat
P35	Piega mm 3,5	Bent mm 3,5
P7	Piega mm 7,5	Bent mm 7,5
P10	Piega mm 10	Bent mm 10
P12	Piega mm 12	Bent mm 12
P15	Piega mm 15	Bent mm 15
	ACCESSORI	ACCESSORIES
	1 ghiera Art.401	1 ring Art.401
7Z	1 controbordo Art. 807	1 striking plate Art. 807
	CONFEZIONE	PACKAGING
	Commercio 20 pz	Boxed in 20's
I	Industria 100 pz	Bulk in 100's

SERIE
21

2131 SERRATURA DA APPLICARE SCREW-ON LOCK



2131	2131 cilindro mm 16 ÷ 20	2131 cylinder mm 16 ÷ 20
P	Per pomolino	For knob
B	FUNZIONAMENTO Rotazione 360° (2 uscite chiave) Rotazione 320° (1 uscita chiave)	OPERATION Rotating 360° (2 key pull) Rotating 320° (1 key pull)
B NE W	SCATOLA (polimero) Marrone Nero Bianco	BODY (polymer) Brown Black White
16 20 23 25 30	CILINDRO Ø 16,5 mm 16 mm 20 mm 23,5 mm 25 mm 30	CYLINDER Ø 16,5 mm 16 mm 20 mm 23,5 mm 25 mm 30
6	Sporgente mm 6 (cilindro ribassato)	Extended core mm 6 (rebated cylinder)
N	Cilindro numerato	Numbered cylinder
A X M	CIFRATURA KD chiavi differenti KA chiavi uguali ..x.. KA gruppi di KA MK chiave maestra	KEY-CHANGE KD keyed differently KA keyed alike ..x.. KA KA in groups MK master key
P8	CHIAVE Art.1804 (2 pz) Art.IP/8 per pomolino 1998 (2 pz)	KEY Art.1804 (2 pcs) Art.IP/8 for knob 1998 (2 pcs)
4 14 BT	FINITURA Ottone decapato (US4) Ottone nichelato (US14) Ottone brunito	FINISH Pickled brass (US4) Nickel plated brass (US14) Burnished plated brass
P9	CATENACCIO Piano P0 Piegato mm 9	BOLT Flat P0 Bent mm 9
BT	FINITURA CATENACCIO Zincato Brunito	BOLT FINISH Zinc plated Burnished
	ACCESSORI 1 ghiera Art.1716 1 controbordo Art.807	ACCESSORIES 1 ring Art.1716 1 striking plate Art.807
I	CONFEZIONE Commercio 20 pz Industria 200 pz	PACKAGING Boxed in 20's Bulk in 200's



2A31M SERRATURA DA APPLICARE SCREW-ON LOCK

SERIE
2A

ex 1/S A

2A31M	1/S A cilindro mm 20	1/S A cylinder mm 20
	FUNZIONAMENTO	OPERATION
	Rotazione 360° (2 uscite chiave)	Rotating 360° (2 key pull)
B	Rotazione 320° (1 uscita chiave)	Rotating 320° (1 key pull)
	SCATOLA (zama)	BODY (die cast)
N	Nichelato	Nickel plated
OT	Ottonato	Brass plated
NE	Nero	Black
BZ	Bronzato	Bronze plated
	CILINDRO Ø 17	CYLINDER Ø 17
20	mm 20	mm 20
22	mm 22	mm 22
25	mm 25	mm 25
30	mm 30	mm 30
	Cilindro numerato	Numbered cylinder
N	Cilindro numerato	Numbered cylinder
	CIFRATURA	KEY-CHANGE
	KD chiavi differenti	KD keyed differently
A	KA chiavi uguali	KA keyed alike
X	...x.. KA gruppi di KA	...x.. KA KA in groups
M	MK chiave maestra	MK master key
	CHIAVE	KEY
	Art.82 nichelato (2 pz)	Art.82 nickel plated (2 pcs)
PUNE	Art.82PU nero per Uniko (2 pz)	Art.82PU black for Uniko (2 pcs)
PUG8	Art.82PU grigio per Uniko (2 pz)	Art.82PU grey for Uniko (2 pcs)
	FINITURA	FINISH
14	Nichelato (US14)	Nickel plated (US14)
OT	Ottonato	Brass plated
BZ	Bronzato	Bronze plated
NE	Nero	Black
	CATENACCIO	BOLT
	Piano	Flat
P35	Piega mm 3,5	Bent mm 3,5
P7	Piega mm 7,5	Bent mm 7,5
P10	Piega mm 10	Bent mm 10
P12	Piega mm 12	Bent mm 12
P15	Piega mm 15	Bent mm 15
	ACCESSORI	ACCESSORIES
	1 ghiera Art.401	1 ring Art.401
7Z	1 controbordo Art. 807	1 striking plate Art. 807
	CONFEZIONE	PACKAGING
	Commercio 20 pz	Boxed in 20's
I	Industria 100 pz	Bulk in 100's

SERIE
2A

2A31R SERRATURA DA APPLICARE SCREW-ON LOCK



ex 3/S A

2A31R	3/S A cilindro mm 20	3/S A cylinder mm 20
	FUNZIONAMENTO	OPERATION
	Rotazione 360° (2 uscite chiave)	Rotating 360° (2 key pull)
B	Rotazione 320° (1 uscita chiave)	Rotating 320° (1 key pull)
	SCATOLA (polimero)	BODY (polymer)
B	Marrone	Brown
NE	Nero	Black
W	Bianco	White
	CILINDRO Ø 17	CYLINDER Ø 17
20	mm 20	mm 20
	CIFRATURA	KEY-CHANGE
	KD chiavi differenti	KD keyed differently
A	KA chiavi uguali	KA keyed alike
X	..x.. KA gruppi di KA	..x.. KA KA in groups
M	MK chiave maestra	MK master key
	CHIAVE	KEY
	Art.82 nichelato (2 pz)	Art.82 nickel plated (2 pcs)
PUNE	Art.82PU nero per Uniko (2 pz)	Art.82PU black for Uniko (2 pcs)
PUG8	Art.82PU grigio per Uniko (2 pz)	Art.82PU grey for Uniko (2 pcs)
	FINITURA	FINISH
14	Nichelato (US14)	Nickel plated (US14)
GR	Ottone grezzo	Rough brass
BZ	Bronzato	Bronze plated
NE	Nero	Black
	CATENACCIO	BOLT
	Piano	Flat
P35	Piega mm 3,5	Bent mm 3,5
P7	Piega mm 7,5	Bent mm 7,5
P10	Piega mm 10	Bent mm 10
P12	Piega mm 12	Bent mm 12
P15	Piega mm 15	Bent mm 15
	ACCESSORI	ACCESSORIES
	1 ghiera Art.401	1 ring Art.401
7Z	1 controbordo Art. 807	1 striking plate Art. 807
	CONFEZIONE	PACKAGING
	Commercio 20 pz	Boxed in 20's
I	Industria 100 pz	Bulk in 100's



2133 SERRATURA PER CHIUSURE MULTIPLE MULTIPLE LOCK

SERIE
21

2133	2133 cilindro mm 16 ÷ 20	2133 cylinder mm 16 ÷ 20
	FUNZIONAMENTO	OPERATION
	Rotazione 360° (2 uscite chiave)	Rotating 360° (2 key pull)
B	Rotazione 180° (1 uscita chiave)	Rotating 180° (1 key pull)
	SCATOLA (polimero)	BODY (polymer)
NE	Nero	Black
	CILINDRO Ø 16,5	CYLINDER Ø 16,5
16	mm 16	mm 16
20	mm 20	mm 20
23	mm 23,5	mm 23,5
25	mm 25	mm 25
30	mm 30	mm 30
6	Sporgente mm 6 (cilindro ribassato)	Extended core mm 6 (rebated cylinder)
N	Cilindro numerato	Numbered cylinder
	CIFRATURA	KEY-CHANGE
	KD chiavi differenti	KD keyed differently
A	KA chiavi uguali	KA keyed alike
X	..x.. KA gruppi di KA	..x.. KA KA in groups
M	MK chiave maestra	MK master key
	CHIAVE	KEY
	Art.1804 (2 pz)	Art.1804 (2 pcs)
	FINITURA	FINISH
4	Ottone decapato (US4)	Pickled brass (US4)
14	Ottone nichelato (US14)	Nickel plated brass (US14)
BT	Ottone brunito	Browned plated brass
	ACCESSORI	ACCESSORIES
	1 ghiera Art.1716	1 ring Art.1716
	CONFEZIONE	PACKAGING
	Commercio 20 pz	Boxed in 20's
I	Industria 200 pz	Bulk in 200's

SERIE
2A

2A33 SERRATURA PER CHIUSURE MULTIPLE MULTIPLE LOCK



ex 175 O

2A33	175 O cilindro mm 20	175 O cylinder mm 20
	FUNZIONAMENTO	OPERATION
	Rotazione 360° Destro (2 uscite chiave)	Rotating 360° Right (2 key pull)
S	Rotazione 360° Sinistro (2 uscite chiave)	Rotating 360° Left (2 key pull)
	CILINDRO Ø 17	CYLINDER Ø 17
20	mm 20	mm 20
22	mm 22	mm 22
25	mm 25	mm 25
30	mm 30	mm 30
N	Cilindro numerato	Numbered cylinder
	CIFRATURA	KEY-CHANGE
	KD chiavi differenti	KD keyed differently
A	KA chiavi uguali	KA keyed alike
X	..x.. KA gruppi di KA	..x.. KA KA in groups
M	MK chiave maestra	MK master key
	CHIAVE	KEY
	Art.82 nichelato (2 pz)	Art.82 nickel plated (2 pcs)
	FINITURA	FINISH
14	Nichelato (US14)	Nickel plated (US14)
OT	Ottonato	Brass plated
BZ	Bronzato	Bronze plated
NE	Nero	Black
	CATENACCIO	BOLT
	Standard	Standard
P35	Lungo mm 3,5	Length mm 3,5
	ACCESSORI	ACCESSORIES
	1 ghiera Art.401	1 ring Art.401
	CONFEZIONE	PACKAGING
	Commercio 20 pz	Boxed in 20's
I	Industria 100 pz	Bulk in 100's



2134 SERRATURA PER CHIUSURE MULTIPLE MULTIPLE LOCK

SERIE
21

2134	2134 cilindro mm 16 ÷ 20	2134 cylinder 16 ÷ 20
	FUNZIONAMENTO	OPERATION
	Rotazione 360° (2 uscite chiave)	Rotating 360° (2 key pull)
B	Rotazione 180° (1 uscita chiave)	Rotating 180° (1 key pull)
	SCATOLA (polimero)	BODY (polymer)
	Nero	Black
	CILINDRO Ø 16,5	CYLINDER Ø 16,5
16	mm 16	mm 16
20	mm 20	mm 20
23	mm 23,5	mm 23,5
25	mm 25	mm 25
30	mm 30	mm 30
6	Sporgente mm 6 (cilindro ribassato)	Extended core mm 6 (rebated cylinder)
N	Cilindro numerato	Numbered cylinder
	CIFRATURA	KEY-CHANGE
	KD chiavi differenti	KD keyed differently
A	KA chiavi uguali	KA keyed alike
X	..x.. KA gruppi di KA	..x.. KA KA in groups
M	MK chiave maestra	MK master key
	CHIAVE	KEY
	Art.1804 (2 pz)	Art.1804 (2 pcs)
	FINITURA	FINISH
4	Ottone decapato (US4)	Pickled brass (US4)
14	Ottone nichelato (US14)	Nickel plated brass (US14)
BT	Ottone brunito	Browned plated brass
	ACCESSORI	ACCESSORIES
	1 ghiera Art.1716	1 ring Art.1716
	CONFEZIONE	PACKAGING
	Commercio 20 pz	Boxed in 20's
I	Industria 200 pz	Bulk in 200's

SERIE
2A

2A34 SERRATURA PER CHIUSURE MULTIPLE MULTIPLE LOCK

ex 175 V



2A34	175 V cilindro mm 20	175 V cylinder mm 20
	FUNZIONAMENTO	OPERATION
	Rotazione 360° Destro (2 uscite chiave)	Rotating 360° Right (2 key pull)
S	Rotazione 360° Sinistro (2 uscite chiave)	Rotating 360° Left (2 key pull)
	CILINDRO Ø 17	CYLINDER Ø 17
20	mm 20	mm 20
22	mm 22	mm 22
25	mm 25	mm 25
30	mm 30	mm 30
N	Cilindro numerato	Numbered cylinder
	CIFRATURA	KEY-CHANGE
	KD chiavi differenti	KD keyed differently
A	KA chiavi uguali	KA keyed alike
X	..x.. KA gruppi di KA	..x.. KA KA in groups
M	MK chiave maestra	MK master key
	CHIAVE	KEY
	Art.82 nichelato (2 pz)	Art.82 nickel plated (2 pcs)
	FINITURA	FINISH
14	Nichelato (US14)	Nickel plated (US14)
OT	Ottonato	Brass plated
BZ	Bronzato	Bronze plated
NE	Nero	Black
	CATENACCIO	BOLT
	Standard	Standard
P35	Lungo mm 3,5	Length mm 3,5
	ACCESSORI	ACCESSORIES
	1 ghiera Art.401	1 ring Art.401
	CONFEZIONE	PACKAGING
	Commercio 20 pz	Boxed in 20's
I	Industria 100 pz	Bulk in 100's



2151 SERRATURA DA APPLICARE SCREW-ON LOCK

SERIE
21

2151	2151 cilindro mm 16	2151 cylinder mm 16
	FUNZIONAMENTO	OPERATION
	Rotazione 90°Destro + 90°Sinistro (1 uscita chiave)	Rotating 90°Right + 90°Left (1 key pull)
B	Rotazione 90°Destro (1 uscita chiave)	Rotating 90°Right (1 key pull)
	CILINDRO Ø M15	CYLINDER Ø M15
16	mm 16	mm 16
20	mm 20	mm 20
25	mm 25	mm 25
30	mm 30	mm 30
	CIFRATURA	KEY-CHANGE
	KD chiavi differenti	KD keyed differently
A	KA chiavi uguali	KA keyed alike
X	... KA gruppi di KA	... KA KA in groups
M	MK chiave maestra	MK master key
	CHIAVE	KEY
	Art.1804 (2 pz)	Art.1804 (2 pcs)
	FINITURA	FINISH
4	Ottonato	Pickled brass
14	Nichelato	Nickel plated brass
BT	Brunito	Browned plated brass
	ACCESSORI	ACCESSORIES
R	Senza rondella	Without washer
	1 rondella 864 x mm 16	1 washer 864 x mm 16
	1 rondella 865 x mm 20-25-30	1 washer 865 x m 20-25-30
	LEVETTA	CAM
L	Senza levetta	Without cam
	Tipo C0 (non applicata)	Type C0 (disassembled)
	CONFEZIONE	PACKAGING
	Commercio 20 pz	Boxed in 20's
I	Industria 200 pz	Bulk in 200's

SERIE
21

21G1 SERRATURA PER CRISTALLI GLASS DOOR LOCK



21G1	21G1	21G1
	FUNZIONAMENTO	OPERATION
	Rotazione 90°Destro + 90°Sinistro (1 uscita chiave)	Rotating 90°Right + 90°Left (1 key pull)
B	Rotazione 90°Destro (1 uscita chiave)	Rotating 90°Right (1 key pull)
	CILINDRO Ø M15	CYLINDER Ø M15
16	mm 16	mm 16
	CIFRATURA	KEY-CHANGE
	KD chiavi differenti	KD keyed differently
A	KA chiavi uguali	KA keyed alike
X	..x.. KA gruppi di KA	..x.. KA KA in groups
M	MK chiave maestra	MK master key
	CHIAVE	KEY
	Art.1804 (2 pz)	Art.1804 (2 pcs)
	FINITURA	FINISH
4	Ottonato	Pickled brass
14	Nichelato	Nickel plated brass
BT	Brunito	Browned plated brass
	ACCESSORI	ACCESSORIES
	1 rosetta Art.860	1 metal plate Art.860
	1 rondella Art.864	1 washer Art.864
	1 rondella Art.861	1 washer Art.861
	LEVETTA	CAM
	Tipo C836	Type C836
	CONFEZIONE	PACKAGING
	Commercio 20 pz	Boxed in 20's
I	Industria 200 pz	Bulk in 200's



21G2 SERRATURA PER CRISTALLI GLASS DOOR LOCK

SERIE
21

21G2	21G2	21G2
	FUNZIONAMENTO	OPERATION
	Rotazione 90°Destro + 90°Sinistro (1 uscita chiave)	Rotating 90°Right + 90°Left (1 key pull)
B	Rotazione 90°Destro (1 uscita chiave)	Rotating 90°Right (1 key pull)
	CILINDRO Ø M15	CYLINDER Ø M15
16	mm 16	mm 16
	CIFRATURA	KEY-CHANGE
	KD chiavi differenti	KD keyed differently
A	KA chiavi uguali	KA keyed alike
X	..x.. KA gruppi di KA	..x.. KA KA in groups
M	MK chiave maestra	MK master key
	CHIAVE	KEY
	Art.1804 (2 pz)	Art.1804 (2 pcs)
	FINITURA	FINISH
4	Ottonato	Pickled brass
14	Nichelato	Nickel plated brass
BT	Brunito	Browned plated brass
	ACCESSORI	ACCESSORIES
	1 rosetta Art.860	1 metal plate Art.860
	1 finto cilindro Art.863	1 dummy cylinder Art.863
	1 controbordo Art.862	1 striking plate Art.862
	2 rondelle Art.864	2 washers Art.864
	2 rondelle Art.861	2 washers Art.861
	LEVETTA	CAM
	Tipo C836	Type C836
	CONFEZIONE	PACKAGING
	Commercio 20 pz	Boxed in 20's
I	Industria 200 pz	Bulk in 200's

SERIE
2A

2A57 SERRATURA FISSAGGIO CON SEEGER NYLON LOCK WITH SEEGER

ex 257



2A57	257 senza levetta	257 without cam
B	FUNZIONAMENTO Rotazione 90° Destro (1 uscite chiave)	OPERATION Rotating 90° Right (1 key pull)
T	Testa quadra Testa tonda	Square head Round head
19	CILINDRO mm 19	CYLINDER mm 19
A	CIFRATURA KD chiavi differenti KA chiavi uguali	KEY-CHANGE KD keyed differently KA keyed alike
	CHIAVE Art.82 nichelata (2 pz)	KEY Art.82 nickel plated (2 pcs)
14	FINITURA Nichelato (US14)	FINISH Nickel plated (US14)
L	LEVETTA Piana Senza levetta	CAM Flat Without cam
	ACCESSORI 1 clip	ACCESSORIES 1 clip
I	CONFEZIONE Commercio 20 pz Industria 100 pz	PACKAGING Boxed in 20's Bulk in 100's



2158 SERRATURA PER SCORREVOLI SLIDING DOOR LOCK

SERIE
21

2158	2158 cilindro mm 16 ÷ 20	2158 cylinder mm 16 ÷ 20
	FUNZIONAMENTO Rotazione 45°+45° (1 uscita chiave)	OPERATION Rotating 45°+45° (1 key pull)
	SCATOLA (polimero) Nero	BODY (polymer) Black
NE	CILINDRO Ø 16,5 mm 16 mm 20 mm 23,5 mm 25 mm 30	CYLINDER Ø 16,5 mm 16 mm 20 mm 23,5 mm 25 mm 30
	N Cilindro numerato	Numbered cylinder
	CIFRATURA KD chiavi differenti KA chiavi uguali ..x.. KA gruppi di KA MK chiave maestra	KEY-CHANGE KD keyed differently KA keyed alike ..x.. KA KA in groups MK master key
	CHIAVE Art.1804 (2 pz)	KEY Art.1804 (2 pcs)
	FINITURA 4 Ottone decapato (US4) 14 Ottone nichelato (US14) BT Ottone brunito	FINISH Pickled brass (US4) Nickel plated brass (US14) Browned plated brass
	ENTRATA 20 mm 20	BACKSET mm 20
	ACCESSORI 1 ghiera Art.1716 1 controbordo Art.808/T	ACCESSORIES 1 ring Art.1716 1 striking plate Art.808/T
	CONFEZIONE Commercio 20 pz I Industria 200 pz	PACKAGING Boxed in 20's Bulk in 200's

SERIE
21

2159 SERRATURA PER SCORREVOLI

SLIDING DOOR LOCK



2159	2159 cilindro mm 16 ÷ 20	2159 cylinder mm 16 ÷ 20
	FUNZIONAMENTO Rotazione 45°+45° (1 uscita chiave)	OPERATION Rotating 45°+45° (1 key pull)
	SCATOLA (polimero) Nero	BODY (polymer) Black
NE		
	CILINDRO Ø 16,5 mm 16	CYLINDER Ø 16,5 mm 16
16	mm 20	mm 20
20	mm 23,5	mm 23,5
23	mm 25	mm 25
25	mm 30	mm 30
30		
N	Cilindro numerato	Numbered cylinder
	CIFRATURA KD chiavi differenti KA chiavi uguali ..x.. KA gruppi di KA MK chiave maestra	KEY-CHANGE KD keyed differently KA keyed alike ..x.. KA KA in groups MK master key
A		
X		
M		
	CHIAVE Art.1804 (2 pz)	KEY Art.1804 (2 pcs)
	FINITURA Ottone decapato (US4) Ottone nichelato (US14) Ottone brunito	FINISH Pickled brass (US4) Nickel plated brass (US14) Browned plated brass
4		
14		
BT		
	ENTRATA mm 20	BACKSET mm 20
20		
	ACCESSORI 1 ghiera Art.1716 1 controbordo Art.808/T	ACCESSORIES 1 ring Art.1716 1 striking plate Art.808/T
	CONFEZIONE Commercio 20 pz Industria 200 pz	PACKAGING Boxed in 20's Bulk in 200's
I		



2165 SERRATURA PER SCORREVOLI SLIDING DOOR LOCK

SERIE
21

2165	2165 cilindro mm 20 ÷ 25	2165 cylinder mm 20 ÷ 25
	FUNZIONAMENTO	OPERATION
	Rotazione 90°+90° (2 uscite chiave)	Rotating 90°+90° (2 key pull)
	CIFRATURA	KEY-CHANGE
	KD chiavi differenti	KD keyed differently
A	KA chiavi uguali	KA keyed alike
X	...x... KA gruppi di KA	...x... KA KA in groups
M	MK chiave maestra	MK master key
	CHIAVE	KEY
	Art.1804 (2 pz)	Art.1804 (2 pcs)
	FINITURA	FINISH
4	Ottone decapato (US4)	Pickled brass (US4)
14	Ottone nichelato (US14)	Nickel plated brass (US14)
BT	Ottone brunito	Browned plated brass
	CILINDRO Ø 20	CYLINDER Ø 20
20	mm 20	mm 20
25	mm 25	mm 25
30	mm 30	mm 30
35	mm 35	mm 35
40	mm 40	mm 40
	LEVETTA	CAM
	Piana E0	Flat E0
	ACCESSORI	ACCESSORIES
	1 ghiera Art.1720	1 ring Art.1720
	CONFEZIONE	PACKAGING
	Commercio 20 pz	Boxed in 20's
I	Industria 100 pz	Bulk in 100's

SERIE
21

2166 SERRATURA PER CRISTALLI GLASS DOOR LOCK



2166	2166	2166
	FUNZIONAMENTO	OPERATION
	Rotazione 90°+90° (2 uscite chiave)	Rotating 90°+90° (2 key pull)
	CILINDRO Ø 20	CYLINDER Ø 20
	mm 20	mm 20
	CIFRATURA	KEY-CHANGE
	KD chiavi differenti	KD keyed differently
A	KA chiavi uguali	KA keyed alike
X	..x.. KA gruppi di KA	..x.. KA KA in groups
M	MK chiave maestra	MK master key
	CHIAVE	KEY
	Art.1804 (2 pz)	Art.1804 (2 pcs)
	FINITURA	FINISH
4	Ottone decapato (US4)	Pickled brass (US4)
14	Ottone nichelato (US14)	Nickel plated brass (US14)
BT	Ottone brunito	Browned plated brass
	LEVETTA	CAM
	Piana E0	Flat E0
	ACCESSORI	ACCESSORIES
	1 ghiera Art. 21GHIE68	1 ring Art. 21GHIE68
	2 rondelle in gomma	2 polymer washers
	CONFEZIONE	PACKAGING
	Commercio 20 pz	Boxed in 20's
I	Industria 200 pz	Bulk in 200's



2167 SERRATURA PER SCORREVOLI SLIDING DOOR LOCK

SERIE
21

2167	2167 cilindro mm 20 ÷ 25	2167 cylinder mm 20 ÷ 25
	FUNZIONAMENTO	OPERATION
	Rotazione 90°+90° (2 uscite chiave)	Rotating 90°+90° (2 key pull)
	CIFRATURA	KEY-CHANGE
	KD chiavi differenti	KD keyed differently
A	KA chiavi uguali	KA keyed alike
X	... KA gruppi di KA	... KA KA in groups
M	MK chiave maestra	MK master key
	CHIAVE	KEY
	Art.1804 (2 pz)	Art.1804 (2 pcs)
	FINITURA	FINISH
4	Ottone decapato (US4)	Pickled brass (US4)
14	Ottone nichelato (US14)	Nickel plated brass (US14)
BT	Ottone brunito	Browned plated brass
	CILINDRO Ø 20	CYLINDER Ø 20
20	mm 20	mm 20
25	mm 25	mm 25
30	mm 30	mm 30
35	mm 35	mm 35
40	mm 40	mm 40
	ACCESSORI	ACCESSORIES
	1 ghiera Art.1720	1 ring Art.1720
	1 bussola controbordo Art.851	1 striking plate socket Art.851
	CONFEZIONE	PACKAGING
	Commercio 20 pz	Boxed in 20's
I	Industria 100 pz	Bulk in 100's

SERIE
21

2168 SERRATURA PER CRISTALLI GLASS DOOR LOCK



2168	2168	2168
	FUNZIONAMENTO	OPERATION
	Rotazione 90°+90° (2 uscite chiave)	Rotating 90°+90° (2 key pull)
	CILINDRO Ø 16,5	CYLINDER Ø 16,5
	mm 20	mm 20
	CIFRATURA	KEY-CHANGE
	KD chiavi differenti	KD keyed differently
A	KA chiavi uguali	KA keyed alike
X	..x.. KA gruppi di KA	..x.. KA KA in groups
M	MK chiave maestra	MK master key
	CHIAVE	KEY
	Art.1804 (2 pz)	Art.1804 (2 pcs)
	FINITURA	FINISH
4	Ottone decapato (US4)	Pickled brass (US4)
14	Ottone nichelato (US14)	Nickel plated brass (US14)
BT	Ottone brunito	Browned plated brass
	ACCESSORI	ACCESSORIES
	1 ghiera Art. 21GHIE68	1 ring Art. 21GHIE68
	2 rondelle in gomma	2 polymer washers
	CONFEZIONE	PACKAGING
	Commercio 20 pz	Boxed in 20's
I	Industria 200 pz	Bulk in 200's



2171 SERRATURA DA APPLICARE SCREW-ON LOCK

SERIE
21

2171	2171 cilindro mm 16 ÷ 20	2171 cylinder mm 16 ÷ 20
	FUNZIONAMENTO	OPERATION
	Rotazione 360° (2 uscite chiave)	Rotating 360° (2 key pull)
B	Rotazione 300° (1 uscita chiave)	Rotating 320° (1 key pull)
	SCATOLA (polimero)	BODY (polymer)
	Nero	Black
	CILINDRO Ø 16,5	CYLINDER Ø 16,5
16	mm 16	mm 16
20	mm 20	mm 20
23	mm 23,5	mm 13,5
25	mm 25	mm 25
30	mm 30	mm 30
6	Sporgente mm 6 (cilindro ribassato)	Extended core mm 6 (rebated cylinder)
N	Cilindro numerato	Numbered cylinder
	CIFRATURA	KEY-CHANGE
	KD chiavi differenti	KD keyed differently
A	KA chiavi uguali	KA keyed alike
X	..x.. KA gruppi di KA	..x.. KA KA in groups
M	MK chiave maestra	MK master key
	CHIAVE	KEY
	Art.1804 (2 pz)	Art.1804 (2 pcs)
	FINITURA	FINISH
4	Ottone decapato (US4)	Pickled brass (US4)
14	Ottone nichelato (US14)	Nickel plated brass (US14)
BT	Ottone brunito	Browned plated brass
	ACCESSORI	ACCESSORIES
	1 ghiera Art.1716	1 ring Art.1716
	CONFEZIONE	PACKAGING
	Commercio 20 pz	Boxed in 20's
I	Industria 100 pz	Bulk in 100's

SERIE
21

2177 SERRATURA DA APPLICARE SCREW-ON LOCK



2177	2177 cilindro mm 16 ÷ 20	2177 cylinder mm 16 ÷ 20
	FUNZIONAMENTO Rotazione 360° (2 uscite chiave)	OPERATION Rotating 360° (2 key pull)
	SCATOLA (polimero) Nero	BODY (polymer) Black
	CILINDRO Ø 16,5 mm 16 mm 20 mm 23,5 mm 25 mm 30	CYLINDER Ø 16,5 mm 16 mm 20 mm 23,5 mm 25 mm 30
	6 Sporgente mm 6 (cilindro ribassato)	Extended core mm 6 (rebated cylinder)
	N Cilindro numerato	Numbered cylinder
	CIFRATURA KD chiavi differenti KA chiavi uguali ..x.. KA gruppi di KA MK chiave maestra	KEY-CHANGE KD keyed differently KA keyed alike ..x.. KA KA in groups MK master key
	CHIAVE Art.1804 (2 pz)	KEY Art.1804 (2 pcs)
	FINITURA 4 Ottone decapato (US4) 14 Ottone nichelato (US14) BT Ottone brunito	FINISH Pickled brass (US4) Nickel plated brass (US14) Browned plated brass
	ACCESSORI 1 ghiera Art.1716	ACCESSORIES 1 ring Art.1716
	CONFEZIONE Commercio 20 pz I Industria 100 pz	PACKAGING Boxed in 20's Bulk in 100's



2182 SERRATURA AD ASTE ROTANTI ESPAGNOLETTE LOCK

SERIE
21

2182	2182 cilindro mm 16 ÷ 20	2182 cylinder mm 16 ÷ 20
P	Per pomolino	For knob
	FISSAGGIO	FIXING
A	A vite	Screw-on
	A pressione	Press-on
NE	SCATOLA (polimero)	BODY (polymer)
	Nero	Black
	FUNZIONAMENTO	OPERATION
	Rotazione 90°Destro (1 uscita chiave)	Rotating 90°Right (1 key pull)
	CILINDRO Ø 16,5	CYLINDER Ø 16,5
16	mm 16	mm 16
20	mm 20	mm 20
23	mm 23,5	mm 23,5
25	mm 25	mm 25
30	mm 30	mm 30
6	Sporgente mm 6 (cilindro ribassato)	Extended core mm 6 (rebated cylinder)
N	Cilindro numerato	Numbered cylinder
	CIFRATURA	KEY-CHANGE
	KD chiavi differenti	KD keyed differently
A	KA chiavi uguali	KA keyed alike
X	..x.. KA gruppi di KA	..x.. KA KA in groups
M	MK chiave maestra	MK master key
	CHIAVE	KEY
	Art.1804 (2 pz)	Art.1804 (2 pcs)
P8	Art.IP/8 per pomolino 1998 (2 pz)	Art.IP/8 for knob 1998 (2 pcs)
	FINITURA	FINISH
4	Ottone decapato (US4)	Pickled brass (US4)
14	Ottone nichelato (US14)	Nickel plated brass (US14)
BT	Ottone brunito	Browned plated brass
	ACCESSORI	ACCESSORIES
	1 ghiera Art.1716	1 ring Art.1716
	CONFEZIONE	PACKAGING
I	Commercio 20 pz	Boxed in 20's
	Industria 100 pz	Bulk in 100's

SERIE
21

2183 SERRATURA AD ASTE ROTANTI ESPAGNOLETTE LOCK



2183	2183 cilindro mm 16 ÷ 20	2183 cylinder mm 16 ÷ 20
P	Per pomolino	For knob
	FISSAGGIO	FIXING
A	A vite	Screw-on
	A pressione	Press-on
NE	SCATOLA (polimero)	BODY (polymer)
	Nero	Black
	FUNZIONAMENTO	OPERATION
	Rotazione 90°Destro (1 uscita chiave)	Rotating 90°Right (1 key pull)
	CILINDRO Ø 16,5	CYLINDER Ø 16,5
16	mm 16	mm 16
20	mm 20	mm 20
23	mm 23,5	mm 23
25	mm 25	mm 25
30	mm 30	mm 30
6	Sporgente mm 6 (cilindro ribassato)	Extended core mm 6 (rebated cylinder)
N	Cilindro numerato	Numbered cylinder
	CIFRATURA	KEY-CHANGE
A	KD chiavi differenti	KD keyed differently
X	KA chiavi uguali	KA keyed alike
M	..x.. KA gruppi di KA	..x.. KA KA in groups
	MK chiave maestra	MK master key
	CHIAVE	KEY
P8	Art.1804 (2 pz)	Art.1804 (2 pcs)
	Art.IP/8 per pomolino 1998 (2 pz)	Art.IP/8 for knob 1998 (2 pcs)
4	FINITURA	FINISH
14	Ottone decapato (US4)	Pickled brass (US4)
BT	Ottone nichelato (US14)	Nickel plated brass (US14)
	Ottone brunito	Browned plated brass
	ACCESSORI	ACCESSORIES
	1 ghiera Art.1716	1 ring Art.1716
	CONFEZIONE	PACKAGING
I	Commercio 20 pz	Boxed in 20's
	Industria 100 pz	Bulk in 100's



2184 SERRATURA AD ASTE ROTANTI ESPAGNOLETTE LOCK

**SERIE
 21**

2184	2184 cilindro mm 16 ÷ 20	2184 cylinder mm 16 ÷ 20
P	Per pomolino	For knob
	FISSAGGIO	FIXING
	A vite	Screw-on
A	A pressione	Press-on
	SCATOLA (zama)	BODY (die cast)
N	Nichelato	Nickel plated
OT	Ottonato	Brass plated
	FUNZIONAMENTO	OPERATION
	Rotazione 360° (2 uscite chiave)	Rotating 360° (2 key pull)
9D	Rotazione 90° Destro (1 uscita chiave)	Rotating 90° Right (1 key pull)
	CILINDRO Ø 16,5	CYLINDER Ø 16,5
16	mm 16	mm 16
20	mm 20	mm 20
23	mm 23,5	mm 23,5
25	mm 25	mm 25
30	mm 30	mm 30
	6	
	Sporgente mm 6 (cilindro ribassato)	Extended core mm 6 (rebated cylinder)
N	Cilindro numerato	Numbered cylinder
	CIFRATURA	KEY-CHANGE
	KD chiavi differenti	KD keyed differently
A	KA chiavi uguali	KA keyed alike
X	..x.. KA gruppi di KA	..x.. KA KA in groups
M	MK chiave maestra	MK master key
	CHIAVE	KEY
	Art.1804 (2 pz)	Art.1804 (2 pcs)
P8	Art.IP/8 per pomolino 1998 (2 pz)	Art.IP/8 for knob 1998 (2 pcs)
	FINITURA	FINISH
4	Ottone decapato (US4)	Pickled brass (US4)
14	Ottone nichelato (US14)	Nickel plated brass (US14)
BT	Ottone brunito	Browned plated brass
	ACCESSORI	ACCESSORIES
	1 ghiera Art.1716	1 ring Art.1716
	CONFEZIONE	PACKAGING
	Commercio 20 pz	Boxed in 20's
I	Industria 100 pz	Bulk in 100's

SERIE
2A

2A84 SERRATURA AD ASTE ROTANTI ESPAGNOLETTE LOCK

ex 423 C/422 C



2A84	Cilindro mm 20	Cylinder 25/32"
	FISSAGGIO	FIXING
	423 C a vite	423 C screw-on
A	422 C a pressione	422 C press-on
	SCATOLA (zama)	BODY (die cast)
N	Nichelato	Nickel plated
BZ	Bronzato	Bronze plated
OT	Ottonato	Brass plated
OA	Ottone antico	Antique brass
NE	Nero	Black
	FUNZIONAMENTO	OPERATION
9D	Rotazione 90° Destro (1 uscita chiave)	Rotating 90° Right (1 key pull)
9S	Rotazione 90° Sinistro (1 uscita chiave)	Rotating 90° Left (1 key pull)
	CILINDRO Ø 17	CYLINDER Ø 17
20	mm 20	mm 20
22	mm 22	mm 22
25	mm 25	mm 25
30	mm 30	mm 30
35	mm 35	mm 35
N	Cilindro numerato	Numbered cylinder
	CIFRATURA	KEY-CHANGE
	KD chiavi differenti	KD keyed differently
A	KA chiavi uguali	KA keyed alike
X	..x.. KA gruppi di KA	..x.. KA KA in groups
M	MK chiave maestra	MK master key
	CHIAVE	KEY
	Art.82 nichelato (2 pz)	Art.82 nickel plated (2 pcs)
	FINITURA	FINISH
14	Nichelato (US14)	Nickel plated (US14)
OT	Ottonato	Brass plated
GR	Ottone grezzo (solo mm 22-35)	Rough brass (only mm 22-35)
NE	Nero	Black
	ACCESSORI	ACCESSORIES
	1 ghiera Art.401	1 ring Art.401
	CONFEZIONE	PACKAGING
	Commercio 10 pz	Boxed in 10's
I	Industria 100 pz	Bulk in 100's



2185 SERRATURA AD ASTE ROTANTI ESPAGNOLETTE LOCK

SERIE
21

2185	2185 cilindro mm 16 ÷ 20	2185 cylinder mm 16 ÷ 20
P	Per pomolino	For knob
	FISSAGGIO	FIXING
	A vite	Screw-on
A	A pressione	Press-on
	SCATOLA (zama)	BODY (die cast)
N	Nichelato	Nickel plated
OT	Ottonato	Brass plated
	FUNZIONAMENTO	OPERATION
	Rotazione 360° (2 uscite chiave)	Rotating 360° (2 key pull)
9D	Rotazione 90°Destro (1 uscita chiave)	Rotating 90°Right (1 key pull)
	CILINDRO Ø 16,5	CYLINDER Ø 16,5
16	mm 16	mm 16
20	mm 20	mm 20
23	mm 23,5	mm 23,5
25	mm 25	mm 25
30	mm 30	mm 30
	6	
	Sporgente mm 6 (cilindro ribassato)	Extended core mm 6 (rebated cylinder)
N	Cilindro numerato	Numbered cylinder
	CIFRATURA	KEY-CHANGE
	KD chiavi differenti	KD keyed differently
A	KA chiavi uguali	KA keyed alike
X	..x.. KA gruppi di KA	..x.. KA KA in groups
M	MK chiave maestra	MK master key
	CHIAVE	KEY
	Art.1804 (2 pz)	Art.1804 (2 pcs)
P8	Art.IP/8 per pomolino 1998 (2 pz)	Art.IP/8 for knob 1998 (2 pcs)
	FINITURA	FINISH
4	Ottone decapato (US4)	Pickled brass (US4)
14	Ottone nichelato (US14)	Nickel plated brass (US14)
BT	Ottone brunito	Browned plated brass
	ENTRATA	BACKSET
15	mm 15	mm 15
20	mm 20	mm 20
	ACCESSORI	ACCESSORIES
	1 ghiera Art.1716	1 ring Art.1716
	CONFEZIONE	PACKAGING
	Commercio 20 pz	Boxed in 20's
I	Industria 100 pz	Bulk in 100's

SERIE
2A

2A85 SERRATURA AD ASTE ROTANTI ESPAGNOLETTE LOCK

ex 223 C/222 C



2A85	Cilindro mm 20	Cylinder mm 20
	FISSAGGIO	FIXING
	223 C a vite	223 C screw-on
A	222 C a pressione	222 C press-on
	SCATOLA (zama)	BODY (die cast)
N	Nichelato	Nickel plated
BZ	Bronzato	Bronze plated
OT	Ottonato	Brass plated
OA	Ottone antico	Antique brass
NE	Nero	Black
	CATENACCIO	BOLT
	Piano	Flat
F	A filo	Cuttet
	CILINDRO Ø 17	CYLINDER Ø 17
20	mm 20	mm 20
22	mm 22	mm 22
25	mm 25	mm 25
30	mm 30	mm 30
35	mm 35	mm 35
N	Cilindro numerato	Numbered cylinder
	CIFRATURA	KEY-CHANGE
	KD chiavi differenti	KD keyed differently
A	KA chiavi uguali	KA keyed alike
X	..x.. KA gruppi di KA	..x.. KA KA in groups
M	MK chiave maestra	MK master key
	CHIAVE	KEY
	Art.82 nichelato (2 pz)	Art.82 nickel plated (2 pcs)
PUNE	Art.82PU nero per Uniko (2 pz)	Art.82PU black for Uniko (2 pcs)
PUG8	Art.82PU grigio per Uniko 82 pz)	Art.82PU grey for Uniko (2 pcs)
	FINITURA	FINISH
14	Nichelato (US14)	Nickel plated (US14)
OT	Ottonato	Brass plated
GR	Ottone grezzo (solo mm 22-35)	Rough brass (only mm 22-35)
NE	Nero	Black
	ACCESSORI	ACCESSORIES
	1 ghiera Art.401	1 ring Art.401
	CONFEZIONE	PACKAGING
	Commercio 10 pz	Boxed in 10's
I	Industria 100 pz	Bulk in 100's



2193 SERRATURA AD ASTE ROTANTI ESPAGNOLETTE LOCK

SERIE
21

2193	2193 cilindro mm 16 ÷ 20	2193 cylinder mm 16 ÷ 20
SCATOLA (polimero)		BODY (polymer)
B	Marrone	Brown
NE	Nero	Black
W	Bianco	White
FUNZIONAMENTO		OPERATION
	Rotazione 360° (2 uscite chiave)	Rotating 360° (2 key pull)
CILINDRO Ø 16,5		CYLINDER Ø 16,5
16	mm 16	mm 16
20	mm 20	mm 20
23	mm 23,5	mm 23,5
25	mm 25	mm 25
30	mm 30	mm 30
6	Sporgente mm 6 (cilindro ribassato)	Extended core mm 6 (rebated cylinder)
N	Cilindro numerato	Numbered cylinder
CIFRATURA		KEY-CHANGE
KD	chiavi differenti	<i>keyed differently</i>
KA	chiavi uguali	<i>keyed alike</i>
..x.. KA	gruppi di KA	<i>KA in groups</i>
MK	chiave maestra	<i>master key</i>
CHIAVE		KEY
	Art.1804 (2 pz)	Art.1804 (2 pcs)
FINITURA		FINISH
4	Ottone decapato (US4)	<i>Pickled brass (US4)</i>
14	Ottone nichelato (US14)	<i>Nickel plated brass (US14)</i>
BT	Ottone brunito	<i>Browned plated brass</i>
ACCESSORI		ACCESSORIES
	1 ghiera Art.1716	1 ring Art.1716
CONFEZIONE		PACKAGING
I	Commercio 20 pz Industria 100 pz	Boxed in 20's Bulk in 100's

SERIE
2A

2A93 SERRATURA AD ASTE ROTANTI ESPAGNOLETTE LOCK

ex 225 C/224 C



2A93	Cilindro mm 20	Cylinder mm 20
	FISSAGGIO	FIXING
	225 C a vite	225 C screw-on
A	224 C a pressione	224 C press-on
	SCATOLA IN Polimero	Polymer BODY
B	Marrone	Brown
NE	Nero	Black
W	Bianco	White
	CILINDRO Ø 17	CYLINDER Ø 17
20	mm 20	mm 20
22	mm 22	mm 22
25	mm 25	mm 25
30	mm 30	mm 30
35	mm 35	mm 35
N	Cilindro numerato	Numbered cylinder
	CIFRATURA	KEY-CHANGE
	KD chiavi differenti	KD keyed differently
A	KA chiavi uguali	KA keyed alike
X	...x.. KA gruppi di KA	...x.. KA KA in groups
M	MK chiave maestra	MK master key
	CHIAVE	KEY
	Art.82 nichelato (2 pz)	Art.82 nickel plated (2 pcs)
PUNE	Art.82PU nero per Uniko (2 pz)	Art.82PU black for Uniko (2 pcs)
PUG8	Art.83PU grigio per Uniko (2 pz)	Art.82PU grey for Uniko (2 pcs)
	FINITURA	FINISH
14	Nichelato	Nickel plated
OT	Ottonato	Brass plated
GR	Ottone grezzo (solo mm 22-35)	Rough brass (only mm 22-35)
NE	Nero	Black
	ACCESSORI	ACCESSORIES
	1 ghiera Art.401	1 ring Art.401
	CONFEZIONE	PACKAGING
	Commercio 10 pz	Boxed in 10's
I	Industria 100 pz	Bulk in 100's



2198 SERRATURA AD ASTE ROTANTI ESPAGNOLETTE LOCK

SERIE
21

2198	2198 cilindro mm 16 ÷ 20	2198 cylinder mm 16 ÷ 20
	SCATOLA (zama)	BODY (die cast)
N	Nichelato	Nickel plated
OT	Ottonato	Brass plated
	FUNZIONAMENTO	OPERATION
	Rotazione 360° (2 uscite chiave)	Rotating 360° (2 key pull)
	CILINDRO Ø 16,5	CYLINDER Ø 16,5
16	mm 16	mm 16
20	mm 20	mm 20
23	mm 23,5	mm 23,5
25	mm 25	mm 25
30	mm 30	mm 30
6	Sporgente mm 6 (cilindro ribassato)	Extended core mm 6 (rebated cylinder)
N	Cilindro numerato	Numbered cylinder
	CIFRATURA	KEY-CHANG
	KD chiavi differenti	KD keyed differently
A	KA chiavi uguali	KA keyed alike
X	..x.. KA gruppi di KA	..x.. KA KA in groups
M	MK chiave maestra	MK master key
	CHIAVE	KEY
	Art.1804 (2 pz)	Art.1804 (2 pcs)
	FINITURA	FINISH
4	Ottone decapato (US4)	Pickled brass (US4)
14	Ottone nichelato (US14)	Nickel plated brass (US14)
BT	Ottone brunito	Browned plated brass
	ACCESSORI	ACCESSORIES
	1 ghiera Art.1716	1 ring Art.1716
	CONFEZIONE	PACKAGING
	Commercio 20 pz	Boxed in 20's
I	Industria 100 pz	Bulk in 100's

info e preventivi
<http://www.bellittiserrature.it/contact.asp>



CILINDRI A SPINE Ø 20
PIN TUMBLER CYLINDERS Ø 20

info e preventivi
<http://www.bellittiserrature.it/contact.asp>



2203 SERRATURA DA APPLICARE SCREW-ON LOCK

SERIE
22

2203	2203 cilindro mm 20	2203 cylinder mm 20
	SCATOLA (acciaio)	BODY (steel)
R	Refilata	Refilated
RN	Refilata nichelata	Nickel plated refilated
OT	Ottonata	Brass plated
ROT	Refilata ottonata	Brass plated refilated
	FUNZIONAMENTO	OPERATION
	Rotazione 360° (2 uscite chiave)	Rotating 360° (2 key pull)
	CILINDRO Ø 20	CYLINDER Ø 20
20	mm 20	mm 20
23	mm 23,5	mm 23,5
30	mm 30	mm 30
35	mm 35	mm 35
40	mm 40	mm 40
	CIFRATURA	KEY-CHANGE
	KD chiavi differenti	KD keyed differently
A	KA chiavi uguali	KA keyed alike
X	...x.. KA gruppi di KA	...x.. KA KA in groups
M	MK chiave maestra	MK master key
	CHIAVE	KEY
	Art.1824 (2 pz)	Art.1824 (2 pcs)
	FINITURA	FINISH
4	Ottone decapato (US4)	Pickled brass (US4)
14	Nichelato (US14)	Nickel plated (US14)
	ENTRATA	BACKSET
20	mm 20	mm 20
25	mm 25	mm 25
30	mm 30	mm 30
35	mm 35	mm 35
40	mm 40	mm 40
50	mm 50	mm 50
	APPLICAZIONE	APPLICATION
	Cassetto e antina destra	Drawer and right hand door
	ACCESSORI	ACCESSORIES
	1 ghiera Art.1720	1 ring Art.1720
	1 controbordo Art.800	1 striking plate Art.800
	CONFEZIONE	PACKAGING
	Commercio 20 pz	Boxed in 20's
I	Industria 100 pz	Bulk in 100's

SERIE
2B

2B11 SERRATURA DA APPLICARE SCREW-ON LOCK

ex 231



2B11	231 cilindro mm 20	231 cylinder mm 20
	APPLICAZIONI	APPLICATIONS
	Cassetto	Drawer
D	Antina destra	Right hand door
	SCATOLA (acciaio)	BODY (steel)
OT	Ottonato	Brass plated
N	Nichelato	Nickel plated
	CILINDRO Ø 20	CYLINDER Ø 20
20	mm 20	mm 20
25	mm 25	mm 25
30	mm 30	mm 30
35	mm 35	mm 35
40	mm 40	mm 40
	CIFRATURA	KEY-CHANGE
	KD chiavi differenti	KD keyed differently
A	KA chiavi uguali	KA keyed alike
X	..x.. KA gruppi di KA	..x.. KA KA in groups
M	MK chiave maestra	MK master key
	CHIAVE	KEY
	Art.82 nichelato (2 pz)	Art.82 nickel plated (2 pcs)
	FINITURA	FINISH
N	Nichelato	Nickel plated
OT	Ottonato	Brass plated
GR	Ottone grezzo (solo mm 35-40)	Rough brass (only mm 35-40)
	ENTRATA	BACKSET
25	mm 25	mm 25
30	mm 30	mm 30
35	mm 35	mm 35
	ACCESSORI	ACCESSORIES
	1 ghiera Art.401-1 controbordo Art.101/A	1 ring Art.401-1 striking plate Art.101/A
7Z	1 ghiera Art.401-1 controbordo Art.827 zincato	1 ring Art.401-1 striking plate Art.827 zinc plated
7O	1 ghiera Art.401-1 controbordo Art.827 ottonato	1 ring Art.401-1 striking plate Art.827 brass plated
	CONFEZIONE	PACKAGING
	Commercio 10 pz	Boxed in 10's
I	Industria 100 pz	Bulk in 100's



2B12 SERRATURA DA INCASTRARE BORE-IN LOCK

SERIE
2B

ex 18 C

2B12	18 C cilindro mm 20	18 C cylinder mm 20
	SCATOLA (acciaio)	BODY (steel)
	Ottonato	Brass plated
N	Nichelato	Nickel plated
ZT	Zincato tropicale	Tropical zinc plated
	CILINDRO Ø 20	CYLINDER Ø 20
20	mm 20	mm 20
25	mm 25	mm 25
30	mm 30	mm 30
35	mm 35	mm 35
40	mm 40	mm 40
	CIFRATURA	KEY-CHANGE
	KD chiavi differenti	KD keyed differently
A	KA chiavi uguali	KA keyed alike
X	..x.. KA gruppi di KA	..x.. KA KA in groups
M	MK chiave maestra	MK master key
	CHIAVE	KEY
	Art.82 nichelato (2 pz)	Art.82 nickel plated (2 pcs)
	FINITURA	FINISH
N	Nichelato	Nickel plated
OT	Ottonato	Brass plated
GR	Ottone grezzo (solo mm 35-40)	Rough brass (only mm 35-40)
	ENTRATA	BACKSET
25	mm 25	mm 25
30	mm 30	mm 30
35	mm 35	mm 35
40	mm 40	mm 40
	APPLICAZIONE	BACKSET
	Cassetto	Drawer
D	Antina destra	Right hand door
	ACCESSORI	ACCESSORIES
	1 ghiera Art.401-1 controbordo Art.101/A	1 ring Art.401-1 striking plate Art.101/A
7Z	1 ghiera Art.401-1 controbordo Art.827 zincato	1 ring Art.401-1 striking plate Art.827 zinc plated
7O	1 ghiera Art.401-1 controbordo Art.827 ottonato	1 ring Art.401-1 striking plate Art.827 brass plated
	CONFEZIONE	PACKAGING
	Commercio 10 pz	Boxed in 10's
I	Industria 100 pz	Bulk in 100's

SERIE
22

2224 SERRATURA PER SCORREVOLI

SLIDING DOOR LOCK



2224	2224 mm 20 ÷ 25	2224 mm 20 ÷ 25
	FUNZIONAMENTO Rotazione 120° (2 uscite chiave)	OPERATION Rotating 120° (2 key pull)
	CIFRATURA KD chiavi differenti KA chiavi uguali ...x.. KA gruppi di KA MK chiave maestra	KEY-CHANGE KD keyed differently KA keyed alike ...x.. KA KA in groups MK master key
	CHIAVE Art.1823 solo mm 20 (2 pz) Art.1824 (2 pz)	KEY Art.1823 only mm 20 (2 pcs) Art.1824 (2 pcs)
	FINITURA 4 Ottone decapato (US4) 14 Nichelato (US14)	FINISH Pickled brass (US4) Nickel plated (US14)
	CILINDRO Ø 22 20 mm 20 25 mm 25 30 mm 30 35 mm 35 40 mm 40	CYLINDER Ø 22 mm 20 mm 25 mm 30 mm 35 mm 40
	ACCESSORI 1 ghiera Art.1720 1 bussola controbordo Art.851 2 viti mm 2,9 x 13	ACCESSORIES 1 ring Art.1720 1 striking plate socket Art.851 2 screw mm 2,9 x 13
	CONFEZIONE Commercio 20 pz 1 Industria 100 pz	PACKAGING Boxed in 20's Bulk in 100's



2229 SERRATURA DA INFILARE MORTISE LOCK

SERIE
22

2229	2229	2229
	FUNZIONAMENTO	OPERATION
	Rotazione 150° (1 uscita chiave)	Rotating 150° (1 key pull)
	CILINDRO Ø 20	CYLINDER Ø 20
26	mm 26	mm 26
	CIFRATURA	KEY-CHANGE
	KD chiavi differenti	KD keyed differently
A	KA chiavi uguali	KA keyed alike
X	..x.. KA gruppi di KA	..x.. KA KA in groups
M	MK chiave maestra	MK master key
	CHIAVE	KEY
	Art.1823 (2 pz)	Art.1823 (2 pcs)
	FINITURA	FINISH
4	Ottone decapato (US4)	Pickled brass (US4)
14	Nichelato (US14)	Nickel plated (US14)
	ACCESSORI	ACCESSORIES
	1 ghiera Art.1720	1 ring Art.1720
	PROLUNGA CATENACCIO	EXTENSION BOLT
53	mm 53	mm 53
P	Senza prolunga	Without extension
	CONFEZIONE	PACKAGING
	Commercio 20 pz	Boxed in 20's
I	Industria 200 pz	Bulk in 200's

SERIE
2B

2B33 SERRATURA DA APPLICARE SCREW-ON LOCK



ex 221 C

2B33	221 C cilindro mm 20	221 C cylinder mm 20
	SCATOLA (polimero)	BODY (polymer)
B	Marrone	Brown
W	Bianco	White
NE	Nero	Black
	CILINDRO Ø 20	CYLINDER Ø 20
20	mm 20	mm 20
25	mm 25	mm 25
30	mm 30	mm 30
35	mm 35	mm 35
40	mm 40	mm 40
	CIFRATURA	KEY-CHANGE
	KD chiavi differenti	KD keyed differently
A	KA chiavi uguali	KA keyed alike
X	..x.. KA gruppi di KA	..x.. KA KA in groups
M	MK chiave maestra	MK master key
	CHIAVE	KEY
	Art.82 nichelato (2 pz)	Art.82 nickel plated (2 pcs)
	FINITURA	FINISH
14	Nichelato (US14)	Nickel plated (US14)
OT	Ottonato	Brass plated
GR	Ottone grezzo (solo mm 35-40)	Rough brass (only mm 35-40)
	ACCESSORI	ACCESSORIES
	1 ghiera Art.401	1 ring Art.401
	CONFEZIONE	PACKAGING
	Commercio 10 pz	Boxed in 10's
I	Industria 100 pz	Bulk in 100's



2241 SERRATURA DA APPLICARE SCREW-ON LOCK

SERIE
22

2241	2241 cilindro mm 20	2241 cylinder mm 20
	FUNZIONAMENTO Rotazione 360° (2 uscite chiave)	OPERATION Rotating 360° (2 key pull)
	SCATOLA Z Acciaio zincato OT Acciaio ottonato	BODY Zinc plated steel Brass plated steel
	CILINDRO Ø 20 20 mm 20 23 mm 23,5 30 mm 30	CYLINDER Ø 20 mm 20 mm 23,5 mm 30
	CIFRATURA KD chiavi differenti A KA chiavi uguali X ..x.. KA gruppi di KA M MK chiave maestra	KEY-CHANGE KD keyed differently KA keyed alike ..x.. KA KA in groups MK master key
	CHIAVE Art.1824 (2 pz)	KEY Art.1824 (2 pcs)
	FINITURA 4 Ottone decapato (US4) 14 Nichelato (US14)	FINISH Pickled brass (US4) Nickel plated (US14)
	APPLICAZIONE Cassetto	APPLICATION Drawer
	ACCESSORI 1 ghiera Art.1720	ACCESSORIES 1 ring Art.1720
	CONFEZIONE I Commercio 20 pz Industria 100 pz	PACKAGING Boxed in 20's Bulk in 100's

SERIE
2B

2B41 SERRATURA DA APPLICARE SCREW-ON LOCK



ex 402 C

2B41	402 C cilindro mm 20	402 C cylinder mm 20
	SCATOLA (acciaio)	BODY (steel)
N	Nichelato	Nickel plated
OT	Ottonato	Brass plated
	CILINDRO Ø 20	CYLINDER Ø 20
20	mm 20	mm 20
25	mm 25	mm 25
30	mm 30	mm 30
40	mm 40	mm 40
	CIFRATURE	KEY-CHANGES
	KD chiavi differenti	KD keyed differently
A	KA chiavi uguali	KA keyed alike
X	..x.. KA gruppi di KA	..x.. KA KA in groups
M	MK chiave maestra	MK master key
	CHIAVE	KEY
	Art.82 nichelato (2 pz)	Art.82 nickel plated (2 pcs)
	FINITURA	FINISH
14	Nichelato (US14)	Nickel plated (US14)
OT	Ottonato	Brass plated
GR	Ottone grezzo (solo mm 40)	Rough brass (only mm 40)
	ACCESSORI	ACCESSORIES
	1 ghiera Art.401	1 ring Art.401
	CONFEZIONE	PACKAGING
	Commercio 10 pz	Boxed in 10's
I	Industria 100 pz	Bulk in 100's



2243 SERRATURA DA APPLICARE SCREW-ON LOCK

SERIE
22

2243	2243 cilindro mm 20	2243 cylinder mm 20
	FUNZIONAMENTO Rotazione 360° (2 uscite chiave)	OPERATION Rotating 360° (2 key pull)
	SCATOLA Z Acciaio zincato OT Acciaio ottonato	BODY Zinc plated steel Brass plated steel
	CILINDRO Ø 20 20 mm 20 23 mm 23,5 30 mm 30	CYLINDER Ø 20 mm 20 mm 23,5 mm 30
	CIFRATURA KD chiavi differenti A KA chiavi uguali X ..x.. KA gruppi di KA M MK chiave maestra	KEY-CHANGE KD keyed differently KA keyed alike ..x.. KA KA in groups MK master key
	CHIAVE Art.1824 (2 pz)	KEY Art.1824 (2 pcs)
	FINITURA 4 Ottone decapato (US4) 14 Nichelato (US14)	FINISH Pickled brass (US4) Nickel plated (US14)
	APPLICAZIONE Antina destra e sinistra	APPLICATION Right hand and left hand door
	ACCESSORI 1 ghiera Art.1720	ACCESSORIES 1 ring Art.1720
	CONFEZIONE I Commercio 20 pz Industria 100 pz	PACKAGING Boxed in 20's Bulk in 100's

SERIE
2B

2B43 SERRATURA DA APPLICARE SCREW-ON LOCK



ex 402 A

2B43	402 A cilindro mm 20	402 A cylinder mm 20
	SCATOLA (acciaio)	BODY (steel)
N	Nichelato	Nickel plated
OT	Ottonato	Brass plated
	CILINDRO Ø 20	CYLINDER Ø 20
20	mm 20	mm 20
25	mm 25	mm 25
30	mm 30	mm 20
40	mm 40	mm 40
	CIFRATURA	KEY-CHANGE
	KD chiavi differenti	KD keyed differently
A	KA chiavi uguali	KA keyed alike
X	..x.. KA gruppi di KA	..x.. KA KA in groups
M	MK chiave maestra	MK master key
	CHIAVE	KEY
	Art.82 nichelato (2 pz)	Art.82 nickel plated (2 pcs)
	FINITURA	FINISH
14	Nichelato (US14)	Nickel plated (US14)
OT	Ottonato	Brass plated
GR	Ottone grezzo (solo mm 40)	Rough brass (only mm 40)
	ACCESSORI	ACCESSORIES
	1 ghiera Art.401	1 ring Art.401
	CONFEZIONE	PACKAGING
	Commercio 10 pz	Boxed in 10's
I	Industria 100 pz	Bulk in 100's



2251 SERRATURA UNIVERSALE IN OTTONE BRASS LOCK

SERIE
22

2251	2251 cilindro mm 16	2251 cylinder mm 16
	FUNZIONAMENTO	OPERATION
	Rotazione 90°Destro + 90°Sinistro (1 uscita chiave)	Rotating 90°Right + 90°Left (1 key pull)
B	Rotazione 90°Destro (1 uscita chiave)	Rotating 90°Right (1 key pull)
	CILINDRO Ø M19	CYLINDER Ø M19
16	mm 16	mm 16
20	mm 20	mm 20
25	mm 25	mm 25
30	mm 30	mm 30
	CIFRATURA	KEY-CHANGE
	KD chiavi differenti	KD keyed differently
A	KA chiavi uguali	KA keyed alike
X	..x.. KA gruppi di KA	..x.. KA KA in groups
M	MK chiave maestra	MK master key
	CHIAVE	KEY
	Art.1824 (2 pz)	Art.1824 (2 pcs)
	FINITURA	FINISH
4	Ottone decapato (US4)	Pickled brass (US4)
14	Nichelato (US14)	Nickel plated (US14)
	ACCESSORIES	ACCESSORIES
R	Senza rondella	Without washer
	1 rondella Art.885 x mm 16	1 washer Art.885 x mm 16
	1 rondella Art.886 x mm 20-25-30	1 washer Art.886 x mm 20-25-30
L	Senza levetta	Without cam
	Piana A0 (non applicata)	Flat A0 (disassembled)
	CONFEZIONE	PACKAGING
	Commercio 20 pz	Boxed in 20's
I	Industria 100 pz	Bulk in 100's
	Maestra 150 pz	Master key boxed in 150's

SERIE
2B

2B64 SERRATURA A STRINGA PASQUIL LOCK

ex 145 C



2B64	145 C cilindro mm 20	145 C cylinder mm 20
	SCATOLA (acciaio)	BODY (steel)
	Ferro grezzo	Rough steel
N	Nichelato	Nickel plated
OT	Ottonato	Brass plated
	APPLICAZIONE	APPLICATION
	Antina destra	Right hand door
S	Antina sinistra	Left hand door
	CILINDRO Ø 20	CYLINDER Ø 20
20	mm 20	mm 20
25	mm 25	mm 25
30	mm 30	mm 30
35	mm 35	mm 35
	CIFRATURA	KEY-CHANGE
	KD chiavi differenti	KD keyed differently
A	KA chiavi uguali	KA keyed alike
X	...x.. KA gruppi di KA	...x.. KA KA in groups
M	MK chiave maestra	MK master key
	CHIAVE	KEY
	Art.82 nichelato (2 pz)	Art.82 nickel plated (2 pcs)
	FINITURA	FINISH
14	Nichelato (US14)	Nickel plated (US14)
OT	Ottonato	Brass plated
GR	Ottone grezzo (solo mm 35-40)	Rough brass (only mm 35-40)
	ACCESSORI	ACCESSORIES
	1 ghiera Art.401	1 ring Art.401
	CONFEZIONE	PACKAGING
	Commercio 20 pz	Boxed in 20's
I	Industria 100 pz	Bulk in 100's



2267 SERRATURA DA INCASTRARE BORE IN- LOCK

SERIE
22

2267	2267 cilindro mm 20	2267 cylinder mm 20
	FUNZIONAMENTO Rotazione 360° (2 uscite chiave)	OPERATION Rotating 360° (2 key pull)
	VERSIONE Standard	VERSION Standard
B	Bis (senza alette di fissaggio)	Bis (without external fixing slots)
	CILINDRO Ø 20 mm 20	CYLINDER Ø 20 mm 20
20	mm 20	mm 20
23	mm 23,5	mm 23,5
30	mm 30	mm 30
	CIFRATURA KD chiavi differenti	KEY-CHANGE KD keyed differently
A	KA chiavi uguali	KA keyed alike
X	..x.. KA gruppi di KA	..x.. KA KA in groups
M	MK chiave maestra	MK master key
	CHIAVE Art.1824 (2 pz)	KEY Art.1824 (2 pcs)
	FINITURA Ottone decapato (US4)	FINISH Pickled brass (US4)
4	Nichelato (US14)	Nickel plated (US14)
14		
	APPLICAZIONE Antina destra e sinistra	APPLICATION Right hand and left hand door
	ACCESSORI 1 ghiera Art.1720 4 cavallotti Art.827 2 contropiastre Art.828	ACCESSORIES 1 ring Art.1720 4 saddles Art.827 2 striking plates Art.828
	CONFEZIONE Commercio 20 pz I Industria 100 pz	PACKAGING Boxed in 20's Bulk in 100's

info e preventivi
<http://www.bellittiserrature.it/contact.asp>

CILINDRI IN POLIMERO/ZAMA
POLYMER/DIE CAST CYLINDER

info e preventivi
<http://www.bellittiserrature.it/contact.asp>



2310 SERRATURA PER SCORREVOLI SLIDING DOOR LOCK

SERIE
23

2310	2310	2310
	CORPO (polimero)	BODY (polimer)
GR	Grigio	Grey
GO	Giallo	Yellow
VE	Verde	Green
NA	Verniciato argento	Enamelled silver
N	Cilindro numerato	Numbered cylinder
	CIFRATURA	KEY-CHANGE
	KD chiavi differenti	KD keyed differently
A	KA chiavi uguali (KA-110)	KA keyed alike (KA-110)
X	..x.. KA gruppi di KA	..x.. KA KA in groups
	CHIAVE	KEY
	Art.1804 (2 pz)	Art.1804 (2 pcs)
	CONFEZIONE	PACKAGING
	60 pz	Boxed in 60's

SERIE
23

2324 SERRATURA PER SCORREVOLI

SLIDING DOOR LOCK



2324	2324 senza clip	2324 without clip
	CORPO (polimero)	BODY (Polymer)
	Nero	Black
	FUNZIONAMENTO	OPERATION
9D	Rotazione 90°Destro (1 uscita chiave)	Rotating 90°Right (1 key pull)
N	Cilindro numerato	Numbered cylinder
	CIFRATURA	KEY-CHANGE
	KD chiavi differenti	KD keyed differently
A	KA chiavi uguali	KA keyed alike
X	..x.. KA gruppi di KA	..x.. KA KA in groups
	CHIAVE	KEY
	Art.1804 (2 pz)	Art.1804 (2 pcs)
	FINITURA	FINISH
14	Nichelato (US14)	Nickel plated (US14)
	ACCESSORI	ACCESSORIES
	Clip "A"	Clip "A"
S	Senza clip	Without clip
	CONFEZIONE	PACKAGING
	Commercio 20 pz	Boxed in 20's
I	Industria 200 pz	Bulk in 200's



2C24 SERRATURA FISSAGGIO CON SEEGER NYLON LOCK WITH SEEGER

SERIE
2C

ex 270

2C24	270	270
	CORPO (polimero)	BODY (polymer)
	Nero	Black
	CIFRATURA	KEY-CHANGE
	KD chiavi differenti	KD <i>keyed differently</i>
A	KA chiavi uguali	KA <i>keyed alike</i>
X	...x.. KA gruppi di KA	...x.. KA <i>KA in groups</i>
M	MK chiave maestra	MK <i>master key</i>
	FINITURA	FINISH
14	Nichelato (US14)	<i>Nickel plated (US14)</i>
	CHIAVE	KEY
	Art.82 nichelato (2 pz)	<i>Art.82 nickel plated (2 pcs)</i>
	ACCESSORI	ACCESSORIES
	1 clip	<i>1 clip</i>
	CONFEZIONE	PACKAGING
	Commercio 20 pz	<i>Boxed in 20's</i>
I	Industria 100 pz	<i>Bulk in 100's</i>

SERIE
23

2352 SERRATURA UNIVERSALE—MONTAGGIO RAPIDO "CLIP IN" CAM LOCK



2352	2352 senza levetta	2352 without cam
B	FUNZIONAMENTO Rotazione 90°Destro (1 uscita chiave)	OPERATION Rotating 90°Right (1 key pull)
NE	CORPO (polimero) Nero	BODY (polimer) Black
N	Cilindro numerato	Numbered cylinder
A	CIFRATURA KD chiavi differenti	KEY-CHANGE KD keyed differently
X	KA chiavi uguali	KA keyed alike
	..x.. KA gruppi di KA	..x.. KA KA in groups
	CHIAVE Art.1804 (2 pz)	KEY Art.1804 (2 pcs)
14	FINITURA Nichelato (US14)	FINISH Nickel plated (US14)
L	LEVETTA Senza levetta	CAM Without cam
C5	Piana C0	Flat C0
C10	Piegata mm 5	Bent 13/64"
	Piegata mm 10	Bent 25/64"
I	CONFEZIONE Industria 250 pz	PACKAGING Bulk in 250's



2C256 SERRATURA FISSAGGIO CON SEEGER NYLON LOCK WITH SEEGER

SERIE
2C

ex 256

2C256	256 cilindro mm 19 senza levetta	256 cylinder mm 19 without cam
	FUNZIONAMENTO	OPERATION
B	Rotazione 90°Destro (1 uscita chiave)	Rotating 90°Right (1 key pull)
S	Rotazione 90°Sinistro (1 uscita chiave)	Rotating 90°Left (1 key pull)
	CORPO (polimero)	BODY (polymer)
NE	Nero	Black
	CILINDRO	CYLINDER
19	mm 19	mm 19
26	mm 26	mm 26
	CIFRATURA	KEY-CHANGE
	KD chiavi differenti	KD keyed differently
A	KA chiavi uguali	KA keyed alike
X	..x.. KA gruppi di KA	..x.. KA KA in groups
	CHIAVE	KEY
	Art.82 nichelato (2 pz)	Art.82 nickel plated (2 pcs)
	FINITURA	FINISH
14	Nichelato (US14)	Nickel plated (US14)
GR	Ottone grezzo	Rough brass
	LEVETTA	CAM
	Piana	Flat
L	Senza levetta	Without cam
	CONFEZIONE	PACKAGING
	Commercio 20 pz	Boxed in 20's
I	Industria 100 pz	Bulk in 100's

info e preventivi
<http://www.bellittiserrature.it/contact.asp>

SERRATURE CILINDRO ESTRAIBILE
REMOVABLE CORE CYLINDER LOCKS

info e preventivi
<http://www.bellittiserrature.it/contact.asp>



2622 SERR. A SCROCCO PER CHIUSURE SPECIALI SPECIAL APPLICATIONS LATCH LOCK

SERIE
26

2622	2622	2622
SERIE	SERIE	SERIES
4	M4 con parapolvere	M4 with dust cover
SCATOLA IN PLASTICA	PLASTIC BODY	PLASTIC BODY
G	Grigio	Grey
FUNZIONAMENTO	OPERATION	OPERATION
	Rotazione 45°+45°	Rotating 45°+45°
USCITA CHIAVE	KEY PULL	KEY PULL
1	1 uscita chiave	1 key pull
CORPO CILINDRO Ø 22 (*)	CYLINDER BODY Ø 22 (*)	CYLINDER BODY Ø 22 (*)
13F	mm 13,5	mm 13,5
CIFRATURE	KEY-CHANGES	KEY-CHANGES
M	Chiavi differenti sotto chiave maestra	Keyed differently under master-key
A	KA chiavi uguali	KA keyed alike
X	Gruppi di KA	Groups of KA
CHIAVI	KEYS	KEYS
	Standard	Standard
CONFEZIONI	PACKAGING	PACKAGING
I	Industria 25 pz	Bulk 25's
	(*) Cilindro non estraibile	(*) Non-removable cylinder core

SERIE
26

2624 SERRATURA A PULSANTE PER SCORREVOLI

SLIDING DOORS PUSH LOCK



2624	2624	2624
SERIE	SERIE	SERIES
0	Senza cilindro	Without cylinder core
1	M1	M1
SERRATURA IN ZAMA	SERRATURA IN ZAMA	DIE CAST BODY
14	Nichelato	Nickel plated
FUNZIONAMENTO	FUNZIONAMENTO	OPERATION
D	Rotazione 90°	Rotating 90°
USCITA CHIAVE	USCITA CHIAVE	KEY PULL
2	2 uscite chiave	2 key pull
CIFRATURE	CIFRATURE	KEY-CHANGES
	Senza cilindro	Without cylinder core
M	Chiavi differenti sotto chiave maestra	Keyed differently under master-key
A	KA chiavi uguali	KA keyed alike
X	Gruppi di KA	Groups of KA
CHIAVI	CHIAVI	KEYS
	Standard	Standard
S	A snodo	Hinged
ACCESSORI IN DOTAZIONE	ACCESSORI IN DOTAZIONE	INCLUDED ACCESSORIES
	1 Clip	1 Clip
CONFEZIONI	CONFEZIONI	PACKAGING
	Commercio 20 pz	Boxed in 20's
I	Industria 100 pz	Bulk 100's



2630 SERRATURA DA APPLICARE SCREW-ON LOCK

SERIE
26

2630	2630	2630
SERIE	SERIE	SERIES
0	Senza cilindro	Without cylinder core
1	M1	M1
SERRATURA IN ZAMA (*)	SERRATURA IN ZAMA (*)	DIE CAST BODY (*)
14	Nichelato	Nickel plated
FUNZIONAMENTO	FUNZIONAMENTO	OPERATION
2	Rotazione 180° (2 uscite chiave)	Rotating 180° (2 key pull)
CORPO CILINDRO Ø 16,5	CORPO CILINDRO Ø 16,5	CYLINDER BODY Ø 16,5
"L"	"L"	"L"
20	mm 20	mm 20
30	mm 30	mm 30
35	mm 35	mm 35
40	mm 40	mm 40
50	mm 50	mm 50
CIFRATURE	CIFRATURE	KEY-CHANGES
Senza cilindro	Senza cilindro	Without cylinder
M	Chiavi differenti sotto chiave maestra	Keyed differently under master-key
A	KA chiavi uguali	KA keyed alike
X	Gruppi di KA	Groups of KA
CHIAVI	CHIAVI	KEYS
Standard	Standard	Standard
S	A snodo	Hinged
CATENACCI	CATENACCI	BOLT
Piano P0 (Standard industria)	Piano P0 (Standard industria)	Flat P0 (Industry standard)
P8	Piano P8 (Standard commercio)	Flat P8 (Commercial standard)
P9	Piegato mm 9	Bent mm 9
ACCESSORI IN DOTAZIONE	ACCESSORI IN DOTAZIONE	ACCESSORIES INCLUDED
	1 ghiera	1 ring
CONFEZIONI	CONFEZIONI	PACKAGING
Commercio 20 pz	Commercio 20 pz	Boxed in 20's
I	Industria 100 pz	Bulk 100's

(*) Finitura NE (nero) a richiesta

(*) NE (black) finish on request

SERIE
26

2631 SERRATURA DA APPLICARE SCREW-ON LOCK



2631	2631	2631
SERIE	SERIE	SERIES
0	Senza cilindro	Without cylinder core
1	M1	M1
SERRATURA IN ZAMA (*)	SERRATURA IN ZAMA (*)	DIE CAST BODY (*)
14	Nichelato	Nickel plated
FUNZIONAMENTO	FUNZIONAMENTO	OPERATION
2	Rotazione 180° (2 uscite chiave)	Rotating 180° (2 key pull)
CORPO CILINDRO Ø 16,5	CORPO CILINDRO Ø 16,5	CYLINDER BODY Ø 16,5
"L"	"L"	"L"
20	mm 20	mm 20
30	mm 30	mm 30
35	mm 35	mm 35
40	mm 40	mm 40
50	mm 50	mm 50
CIFRATURE	CIFRATURE	KEY-CHANGES
	Senza cilindro	Without cylinder
M	Chiavi differenti sotto chiave maestra	Keyed differently under master-key
A	KA chiavi uguali	KA keyed alike
X	Gruppi di KA	Groups of KA
CHIAVI	CHIAVI	KEYS
	Standard	Standard
S	A snodo	Hinged
CATENACCI	CATENACCI	BOLT
	Piano P0	Flat P0
P8	Piano P8 (Standard commercio)	Flat P8 (Commercial standard)
P9	Piegato mm 9	Bent mm 9
ACCESSORI IN DOTAZIONE	ACCESSORI IN DOTAZIONE	INCLUDED ACCESSORIES
	1 ghiera	1 ring
CONFEZIONI	CONFEZIONI	PACKAGING
	Commercio 20 pz	Boxed in 20's
I	Industria 100 pz	Bulk 100's

(*) Finitura NE (nero) a richiesta

(*) NE (black) finish on request



2632 SERRATURA PER CHIUSURE MULTIPLE MULTIPLE LOCK

SERIE
26

2632	2632	2632
SERIE	SERIE	SERIES
0	Senza cilindro	Without cylinder core
1	M1	M1
SERRATURA IN ZAMA (*)	SERRATURA IN ZAMA (*)	DIE CAST BODY (*)
14	Nichelato	Nickel plated
FUNZIONAMENTO	FUNZIONAMENTO	OPERATION
	Rotazione 180°	Rotating 180°
USCITA CHIAVE	USCITA CHIAVE	KEY PULL
2	2 uscite chiave	2 key pull
CORPO CILINDRO Ø 16,5	CORPO CILINDRO Ø 16,5	CYLINDER BODY Ø 16,5
20	mm 20	mm 20
CIFRATURE	CIFRATURE	KEY-CHANGES
	Senza cilindro	Without cylinder
M	Chiavi differenti sotto chiave maestra	Keyed differently under master-key
A	KA chiavi uguali	KA keyed alike
X	Gruppi di KA	Groups of KA
CHIAVI	CHIAVI	KEYS
	Standard	Standard
S	A snodo	Hinged
CATENACCI	CATENACCI	BOLT
	"A"	"A"
2	mm 600	mm 600
ACCESSORI IN DOTAZIONE	ACCESSORI IN DOTAZIONE	INCLUDED ACCESSORIES
	1 ghiera	1 ring
CONFEZIONI	CONFEZIONI	PACKAGING
	Commercio 20 pz	Boxed in 20's
I	Industria 100 pz	Bulk 100's

(*) Finitura NE (nero) a richiesta

(*) NE (black) finish on request

SERIE
26

2633 SERRATURA PER CHIUSURE MULTIPLE MULTIPLE LOCK



2633	2633	2633	
SERIE	SERIE	SERIES	
0	Senza cilindro	Without cylinder core	
1	M1	M1	
SERRATURA IN ZAMA (*)	SERRATURA IN ZAMA (*)	DIE CAST BODY (*)	
14	Nichelato	Nickel plated	
	Standard	Standard	
R	Refilata	Single wing	
FUNZIONAMENTO	FUNZIONAMENTO	OPERATION	
	Rotazione 180°	Rotating 180°	
USCITA CHIAVE	USCITA CHIAVE	KEY PULL	
2	2 uscite chiave	2 key pull	
CORPO CILINDRO Ø 16,5	CORPO CILINDRO Ø 16,5	CYLINDER BODY Ø 16,5	
20	mm 20	mm 20	
CIFRATURE	CIFRATURE	KEY-CHANGES	
	Senza cilindro	Without cylinder	
M	Chiavi differenti sotto chiave maestra	Keyed differently under master-key	
A	KA chiavi uguali	KA keyed alike	
X	Gruppi di KA	Groups of KA	
CHIAVI	CHIAVI	KEYS	
	Standard	Standard	
S	A snodo	Hinged	
ACCESSORI IN DOTAZIONE	ACCESSORI IN DOTAZIONE	INCLUDED ACCESSORIES	
	1 ghiera	1 ring	
CONFEZIONI	CONFEZIONI	PACKAGING	
	Commercio 20 pz	Boxed in 20's	
I	Industria 100 pz	Bulk 100's	

(*) Finitura NE (nero) a richiesta

(*) NE (black) finish on request



2634 SERRATURA PER CHIUSURE MULTIPLE MULTIPLE LOCK

SERIE
26

2634	2634	2634
SERIE	SERIE	SERIES
0	Senza cilindro	Without cylinder core
1	M1	M1
SERRATURA IN ZAMA (*)	SERRATURA IN ZAMA (*)	DIE CAST BODY (*)
14	Nichelato	Nickel plated
Standard	Standard	Standard
R	Refilata	Single wing
FUNZIONAMENTO	FUNZIONAMENTO	OPERATION
	Rotazione 180°	Rotating 180°
USCITA CHIAVE	USCITA CHIAVE	KEY PULL
2	2 uscite chiave	2 key pull
CORPO CILINDRO Ø 16,5	CORPO CILINDRO Ø 16,5	CYLINDER BODY Ø 16,5
20	mm 20	mm 20
CIFRATURE	CIFRATURE	KEY-CHANGES
	Senza cilindro	Without cylinder
M	Chiavi differenti sotto chiave maestra	Keyed differently under master-key
A	KA chiavi uguali	KA keyed alike
X	Gruppi di KA	Groups of KA
CHIAVI	CHIAVI	KEYS
	Standard	Standard
S	A snodo	Hinged
ACCESSORI IN DOTAZIONE	ACCESSORI IN DOTAZIONE	INCLUDED ACCESSORIES
	1 ghiera	1 ring
CONFEZIONI	CONFEZIONI	PACKAGING
	Commercio 20 pz	Boxed in 20's
I	Industria 100 pz	Bulk 100's

(*) Finitura NE (nero) a richiesta

(*) NE (black) finish on request

SERIE
26

2635 SERRATURA A SCROCCO LATCH LOCK



2635	2635	2635	
SERIE	SERIE	SERIES	
1	M1	M1	
SERRATURA IN ZAMA	SERRATURA IN ZAMA	DIE CAST BODY	
14	Nichelato	Nickel plated	
FUNZIONAMENTO	FUNZIONAMENTO	OPERATION	
	Rotazione 180°	Rotating 180°	
USCITA CHIAVE	USCITA CHIAVE	KEY PULL	
2	2 uscite chiave	2 key pull	
CORPO CILINDRO Ø 16,5	CORPO CILINDRO Ø 16,5	CYLINDER BODY Ø 16,5	
20	mm 20	mm 20	
CIFRATURE	CIFRATURE	KEY-CHANGES	
M	Chiavi differenti sotto chiave maestra	Keyed differently under master-key	
A	KA chiavi uguali	KA keyed alike	
X	Gruppi di KA	Groups of KA	
CHIAVI	CHIAVI	KEYS	
	Standard	Standard	
S	A snodo	Hinged	
ACCESSORI IN DOTAZIONE	ACCESSORI IN DOTAZIONE	INCLUDED ACCESSORIES	
	1 ghiera	1 ring	
CONFEZIONI	CONFEZIONI	PACKAGING	
	Commercio 20 pz	Boxed in 20's	
I	Industria 100 pz	Bulk 100's	



2639 SERRATURA DA APPLICARE SCREW-ON LOCK

SERIE
26

2639	2639	2639
SERIE		SERIES
0	Senza cilindro	Without cylinder core
1	M1	M1
SERRATURA IN ZAMA		DIE CAST BODY
14	Nichelato	Nickel plated
FUNZIONAMENTO		OPERATION
P	Rotazione 180°	Rotating 180°
	Rotazione 90° DX	Rotating 90° R
USCITA CHIAVE		KEY PULL
2	2 uscite chiave	2 key pull
CORPO CILINDRO Ø 16,5		CYLINDER BODY Ø 16,5
20	mm 20	mm 20
CIFRATURE		KEY-CHANGES
	Senza cilindro	Without cylinder
M	Chiavi differenti sotto chiave maestra	Keyed differently under master-key
A	KA chiavi uguali	KA keyed alike
X	Gruppi di KA	Groups of KA
CHIAVI		KEYS
	Standard	Standard
S	A snodo	Hinged
ACCESSORI IN DOTAZIONE		INCLUDED ACCESSORIES
	Levetta piana A35	Flat cam A35
	1 ghiera	1 ring
CONFEZIONI		PACKAGING
	Commercio 20 pz	Boxed in 20's
I	Industria 100 pz	Bulk in 100's

SERIE
26

2640 SERRATURA DA APPLICARE SCREW-ON LOCK



2640	2640	2640
SERIE	SERIE	SERIES
0	Senza cilindro	Without cylinder core
1	M1	M1
SERRATURA IN ZAMA	SERRATURA IN ZAMA	DIE CAST BODY
14	Nichelato	Nickel plated
FUNZIONAMENTO	FUNZIONAMENTO	OPERATION
P	Rotazione 180°	Rotating 180°
	Rotazione 90° DX	Rotating 90° R
USCITA CHIAVE	USCITA CHIAVE	KEY PULL
2	2 uscite chiave	2 key pull
CORPO CILINDRO Ø 16,5	CORPO CILINDRO Ø 16,5	CYLINDER BODY Ø 16,5
20	mm 20	mm 20
CIFRATURE	CIFRATURE	KEY-CHANGES
	Senza cilindro	Without cylinder
M	Chiavi differenti sotto chiave maestra	Keyed differently under master-key
A	KA chiavi uguali	KA keyed alike
X	Gruppi di KA	Groups of KA
CHIAVI	CHIAVI	KEYS
	Standard	Standard
S	A snodo	Hinged
LEVETTE	LEVETTE	CAMS
L	Senza levetta	Without cam
	Piana A35	Flat A35
ACCESSORI IN DOTAZIONE	ACCESSORI IN DOTAZIONE	INCLUDED ACCESSORIES
	Levetta piana A35	Flat cam A35
	1 ghiera	1 ring
CONFEZIONI	CONFEZIONI	PACKAGING
	Commercio 20 pz	Boxed in 20's
I	Industria 100 pz	Bulk in 100's



2642 SERR. DA APPLICARE A DOPPIO CATENACCIO DOUBLE BOLT SCREW-ON LOCK

SERIE
26

2642	2642	2642
SERIE		SERIES
0	Senza cilindro	Without cylinder core
1	M1	M1
SERRATURA IN ZAMA		DIE CAST BODY
14	Nichelato	Nickel plated
FUNZIONAMENTO		OPERATION
2	Rotazione 360° (2 uscite chiave) (*)	Rotating 360° (2 key pull) (*)
CORPO CILINDRO Ø 16,5		CYLINDER BODY Ø 16,5
20	mm 20	mm 20
CIFRATURE		KEY-CHANGES
	Senza cilindro	Without cylinder
M	Chiavi differenti sotto chiave maestra	Keyed differently under master-key
A	KA chiavi uguali	KA keyed alike
X	Gruppi di KA	Groups of KA
CHIAVI		KEYS
	Standard	Standard
S	A snodo	Hinged
ACCESSORI IN DOTAZIONE		INCLUDED ACCESSORIES
	1 ghiera + O810/R	1 ring + O810/R
CONFEZIONI		PACKAGING
	Commercio 20 pz	Boxed in 20's
I	Industria 100 pz	Bulk 100's

SERIE
26

2650 SERRATURA UNIVERSALE CAM LOCK



2650	2650 Ø mm 16	2650 Ø mm 16
SERIE		SERIES
6	M6	M6
FUNZIONAMENTO		OPERATION
P	Rotazione 180°	Rotating 180°
D	Rotazione 90° DX	Rotating 90° R
USCITA CHIAVE		KEY PULL
2	2 uscite chiave (180°)	2 key pull (180°)
1	1 uscita chiave (90° DX)	1 key pull (90° R)
CORPO CILINDRO Ø M15		CYLINDER BODY Ø M15
"L"		"L"
16	mm 16	mm 16
20	mm 20	mm 20
CIFRATURE		KEY-CHANGES
M	Chiavi differenti sotto chiave maestra	Keyed differently under master-key
A	KA chiavi uguali	KA keyed alike
X	Gruppi di KA	Groups of KA
CHIAVI		KEYS
	Standard	Standard
FINITURE		FINISHES
14	Nichelato	Nickel plated
OT	Ottonato	Brass plated
NE	Nero	Black plated
FISSAGGIO		FIXING
D	Con dado	With nut
ACCESSORI IN DOTAZIONE		INCLUDED ACCESSORIES
	1 rondella Art. 864 (solo mm 16)	1 ring Art. 864 (only mm 16)
	1 rondella Art. 865 (solo mm 20)	1 ring Art. 865 (only mm 20)
LEVETTE		CAMS
C0	Piana C0	Flat C0
CONFEZIONI		PACKAGING
	Commercio 20 pz	Boxed in 20's
I	Industria 100 pz	Bulk in 100's



2651 SERRATURA UNIVERSALE CAM LOCK

SERIE
26

2651	2651 Ø mm 19
SERIE	M1
1	
FUNZIONAMENTO	
P	Rotazione 180°
D	Rotazione 90° DX
USCITA CHIAVE	
2	2 uscite chiave (180°)
1	1 uscita chiave (90° DX)
CORPO CILINDRO Ø M19	"L"
11	mm 11
16	mm 16
20	mm 20
25	mm 25
30	mm 30
CIFRATURE	
M	Chiavi differenti sotto chiave maestra
A	KA chiavi uguali
X	Gruppi di KA
CHIAVI	
	Standard
FINITURE	
14	Nichelato
FISSAGGIO	
C	Con clip
D	Con dado
LEVETTE	
35	Piana A35
CONFEZIONI	
	Commercio 20 pz
I	Industria 100 pz

2651 Ø mm 19	
SERIES	M1
OPERATION	
	Rotating 180°
	Rotating 90° R
KEY PULL	
	2 key pull (180°)
	1 key pull (90° R)
CYLINDER BODY Ø M19	"L"
	mm 11
	mm 16
	mm 20
	mm 25
	mm 30
KEY-CHANGES	
	Keyed differently under master-key
	KA keyed alike
	Groups of KA
KEYS	
	Standard
FINISHES	
	Nickel plated
FIXING	
	With clip
	With nut
CAMS	
	Flat A35
PACKAGING	
	Boxed in 20's
	Bulk in 100's

SERIE
26

2652 SERRATURA UNIVERSALE CAM LOCK



2652	2652	2652
1	SERIE M1	SERIES M1
P	FUNZIONAMENTO Rotazione 180°	OPERATION Rotating 180°
2	USCITA CHIAVE 2 uscite chiave (180°)	KEY PULL 2 key pull (180°)
20	CORPO CILINDRO Ø 19 mm 20	CYLINDER BODY Ø 19 mm 20
M	CIFRATURE Chiavi differenti sotto chiave maestra	KEY-CHANGES Keyed differently under master-key
A	KA chiavi uguali	KA keyed alike
X	Gruppi di KA	Groups of KA
S	CHIAVI A snodo	KEYS Hinged
14	FINITURE Nichelato	FINISHES Nickel plated
C	FISSAGGIO Con clip	FIXING With clip
30	LEVETTE Con perno mm 30	CAMS With pin mm 30
I	CONFEZIONI Commercio 20 pz Industria 100 pz	PACKAGING Boxed in 20's Bulk in 100's



2659 SERRATURA PER SCORREVOLI SLIDING DOORS LOCK

SERIE
26

2659	2659	2659
SERIE	SERIE	SERIES
1	M1	M1
SERRATURA IN ZAMA	DIE CAST BODY	DIE CAST BODY
14	Nichelato	Nickel plated
FUNZIONAMENTO	OPERATION	OPERATION
	Rotazione 90° DX	Rotating 90° R
USCITA CHIAVE	KEY PULL	KEY PULL
2	2 uscite chiave	2 key pull
CORPO CILINDRO Ø 16,5	CYLINDER BODY Ø 16,5	CYLINDER BODY Ø 16,5
20	mm 20	mm 20
CIFRATURE	KEY-CHANGES	KEY-CHANGES
M	Chiavi differenti sotto chiave maestra	Keyed differently under master-key
A	KA chiavi uguali	KA keyed alike
X	Gruppi di KA	Groups of KA
CHIAVI	KEYS	KEYS
	Standard	Standard
S	A snodo	Hinged
ENTRATA	BACKSET	BACKSET
	"E"	"E"
25	mm 25	mm 25
ACCESSORI IN DOTAZIONE	INCLUDED ACCESSORIES	INCLUDED ACCESSORIES
	1 ghiera	1 ring
	1 controbordo	1 striking plate
CONFEZIONI	PACKAGING	PACKAGING
	Commercio 20 pz	Boxed in 20's
I	Industria 100 pz	Bulk in 100's

SERIE
26

2665 SERRATURA A PULSANTE PER SCORREVOLI

SLIDING DOORS PUSH LOCK



2665	2665	2665	
	SERIE	SERIES	
1	M1	M1	
	SERRATURA IN ZAMA	DIE CAST BODY	
14	Nichelato	Nickel plated	
	FUNZIONAMENTO	OPERATION	
	Rotazione 90°	Rotating 90°	
	USCITA CHIAVE	KEY PULL	
2	2 uscite chiave	2 key pull	
	CORPO CILINDRO Ø 18	CYLINDER BODY Ø 18	
25	mm 25	mm 25	
	CIFRATURE	KEY-CHANGES	
M	Chiavi differenti sotto chiave maestra	Keyed differently under master-key	
A	KA chiavi uguali	KA keyed alike	
X	Gruppi di KA	Groups of KA	
	CHIAVI	KEYS	
	Standard	Standard	
S	A snodo	Hinged	
	ACCESSORI IN DOTAZIONE	INCLUDED ACCESSORIES	
	1 ghiera	1 ring	
	1 controbordo a squadra	1 angular striking plate	
	CONFEZIONI	PACKAGING	
	Commercio 20 pz	Boxed in 20's	
I	Industria 100 pz	Bulk in 100's	



2667 SERRATURA A PULSANTE PER SCORREVOLI SLIDING DOORS PUSH LOCK

SERIE
26

2667	2667	2667
SERIE	SERIE	SERIES
1	M1	M1
FUNZIONAMENTO	OPERATION	OPERATION
	Rotazione 45°	Rotating 45°
USCITA CHIAVE	KEY PULL	KEY PULL
2	2 uscite chiave	2 key pull
CORPO CILINDRO Ø 18	CYLINDER BODY Ø 18	CYLINDER BODY Ø 18
25	mm 25	mm 25
CIFRATURE	KEY-CHANGES	KEY-CHANGES
M	Chiavi differenti sotto chiave maestra	Keyed differently under master-key
A	KA chiavi uguali	KA keyed alike
X	Gruppi di KA	Groups of KA
CHIAVI	KEYS	KEYS
	Standard	Standard
S	A snodo	Hinged
FINITURE	FINISHES	FINISHES
14	Nichelato	Nickel plated
ACCESSORI IN DOTAZIONE	INCLUDED ACCESSORIES	INCLUDED ACCESSORIES
	1 ghiera	1 ring
CONFEZIONI	PACKAGING	PACKAGING
	Commercio 20 pz	Boxed in 20's
I	Industria 100 pz	Bulk in 100's

SERIE
26

2675 SERRATURA AD ASTE TRASLANTI SLIDING BARS LOCK



2675	2675	2675
SERIE	SERIE	SERIES
0	Senza cilindro	Without cylinder core
1	M1	M1
SERRATURA IN ZAMA	SERRATURA IN ZAMA	DIE CAST BODY
14	Nichelato	Nickel plated
FUNZIONAMENTO	FUNZIONAMENTO	OPERATION
	Rotazione 90° + 90°	Rotating 90° + 90°
USCITA CHIAVE	USCITA CHIAVE	KEY PULL
2	2 uscite chiave	2 key pull
CORPO CILINDRO Ø 16,5	CORPO CILINDRO Ø 16,5	CYLINDER BODY Ø 16,5
20	mm 20	mm 20
CIFRATURE	CIFRATURE	KEY-CHANGES
	Senza cilindro	Without cylinder
M	Chiavi differenti sotto chiave maestra	Keyed differently under master-key
A	KA chiavi uguali	KA keyed alike
X	Gruppi di KA	Groups of KA
CHIAVI	CHIAVI	KEYS
	Standard	Standard
S	A snodo	Hinged
ACCESSORI IN DOTAZIONE	ACCESSORI IN DOTAZIONE	INCLUDED ACCESSORIES
	1 ghiera	1 ring
CONFEZIONI	CONFEZIONI	PACKAGING
	Commercio 20 pz	Boxed in 20's
I	Industria 100 pz	Bulk in 100's



2676 SERRATURA AD ASTE TRASLANTI SLIDING BARS LOCK

SERIE
26

2676	2676	2676
SERIE	SERIE	SERIES
0	Senza cilindro	Without cylinder core
1	M1	M1
SERRATURA IN ZAMA	SERRATURA IN ZAMA	DIE CAST BODY
14	Nichelato	Nickel plated
FUNZIONAMENTO	FUNZIONAMENTO	OPERATION
	Rotazione 90° + 90°	Rotating 90° + 90°
USCITA CHIAVE	USCITA CHIAVE	KEY PULL
2	2 uscite chiave	2 key pull
CORPO CILINDRO Ø 16,5	CORPO CILINDRO Ø 16,5	CYLINDER BODY Ø 16,5
20	mm 20	mm 20
CIFRATURE	CIFRATURE	KEY-CHANGES
	Senza cilindro	Without cylinder
M	Chiavi differenti sotto chiave maestra	Keyed differently under master-key
A	KA chiavi uguali	KA keyed alike
X	Gruppi di KA	Groups of KA
CHIAVI	CHIAVI	KEYS
	Standard	Standard
S	A snodo	Hinged
ACCESSORI IN DOTAZIONE	ACCESSORI IN DOTAZIONE	INCLUDED ACCESSORIES
	1 ghiera	1 ring
CONFEZIONI	CONFEZIONI	PACKAGING
	Commercio 20 pz	Boxed in 20's
I	Industria 100 pz	Bulk in 100's

SERIE
26

2677 SERRATURA "SLIM" AD ASTE ROTANTI "SLIM" ESPAGNOLETTE LOCK



2677	2677	2677
SERIE	SERIE	SERIES
0	Senza cilindro	Without cylinder core
1	M1	M1
FISSAGGIO	FIXING	FIXING
A vite	A vite	Screw-on
A	A pressione	Press-on
SERRATURA IN ZAMA	DIE CAST BODY	DIE CAST BODY
14	Nichelato	Nickel plated
FUNZIONAMENTO	OPERATION	OPERATION
	Rotazione 90° + 90°	Rotating 90° + 90°
USCITA CHIAVE	KEY PULL	KEY PULL
2	2 uscite chiave	2 key pull
CORPO CILINDRO Ø 16,5	CYLINDER BODY Ø 16,5	CYLINDER BODY Ø 16,5
20	mm 20	mm 20
CIFRATURE	KEY-CHANGES	KEY-CHANGES
	Senza cilindro	Without cylinder
M	Chiavi differenti sotto chiave maestra	Keyed differently under master-key
A	KA chiavi uguali	KA keyed alike
X	Gruppi di KA	Groups of KA
CHIAVI	KEYS	KEYS
	Standard	Standard
S	A snodo	Hinged
ACCESSORI IN DOTAZIONE	INCLUDED ACCESSORIES	INCLUDED ACCESSORIES
	1 ghiera	1 ring
CONFEZIONI	PACKAGING	PACKAGING
	Commercio 20 pz	Boxed in 20's
I	Industria 100 pz	Bulk in 100's



2686 SERRATURA AD ASTE ROTANTI ESPAGNOLETTE LOCK

SERIE
26

2686	2686	2686
SERIE		SERIES
0	Senza cilindro	Without cylinder core
1	M1	M1
FISSAGGIO		FIXING
	A vite	Screw-on
A	A pressione	Press-on
SERRATURA IN ZAMA		DIE CAST BODY
14	Nichelato	Nickel plated
FUNZIONAMENTO		OPERATION
	Rotazione 90° + 90°	Rotating 90° + 90°
USCITA CHIAVE		KEY PULL
2	2 uscite chiave	2 key pull
CORPO CILINDRO Ø 16,5		CYLINDER BODY Ø 16,5
	"L"	"L"
20	mm 20	mm 20
25	mm 25	mm 25
30	mm 30	mm 30
CIFRATURE		KEY-CHANGES
	Senza cilindro	Without cylinder
M	Chiavi differenti sotto chiave maestra	Keyed differently under master-key
A	KA chiavi uguali	KA keyed alike
X	Gruppi di KA	Groups of KA
CHIAVI		KEYS
	Standard	Standard
S	A snodo	Hinged
ACCESSORI IN DOTAZIONE		INCLUDED ACCESSORIES
	1 ghiera	1 ring
CONFEZIONI		PACKAGING
	Commercio 20 pz	Boxed in 20's
I	Industria 100 pz	Bulk in 100's

SERIE
26

2687 SERRATURA AD ASTE ROTANTI ESPAGNOLETTE LOCK



2687	2687	2687
SERIE	SERIE	SERIES
0	Senza cilindro	Without cylinder core
1	M1	M1
FISSAGGIO	FIXING	FIXING
	A vite	Screw-on
A	A pressione	Press-on
SERRATURA IN ZAMA	DIE CAST BODY	DIE CAST BODY
14	Nichelato	Nickel plated
FUNZIONAMENTO	OPERATION	OPERATION
	Rotazione 90° + 90°	Rotating 90° + 90°
USCITA CHIAVE	KEY PULL	KEY PULL
2	2 uscite chiave	2 key pull
CORPO CILINDRO Ø 16,5	CYLINDER BODY Ø 16,5	CYLINDER BODY Ø 16,5
20	mm 20	mm 20
25	mm 25	mm 25
30	mm 30	mm 30
CIFRATURE	KEY-CHANGES	KEY-CHANGES
	Senza cilindro	Without cylinder
M	Chiavi differenti sotto chiave maestra	Keyed differently under master-key
A	KA chiavi uguali	KA keyed alike
X	Gruppi di KA	Groups of KA
CHIAVI	KEYS	KEYS
	Standard	Standard
S	A snodo	Hinged
ENTRATA	BACKSET	BACKSET
	"E"	"E"
15	mm 15	mm 15
25	mm 25	mm 25
ACCESSORI IN DOTAZIONE	INCLUDED ACCESSORIES	INCLUDED ACCESSORIES
	1 ghiera	1 ring
CONFEZIONI	PACKAGING	PACKAGING
	Commercio 20 pz	Boxed in 20's
I	Industria 100 pz	Bulk in 100's



2688 SERR. ASTE ROTANTI PER CHIUSURE MULTIPLE ESPAGNOLETTE MULTIPLE LOCK

SERIE
26

2688	2688	2688
SERIE		SERIES
0	Senza cilindro	Without cylinder core
1	M1	M1
FISSAGGIO		FIXING
	A vite	Screw-on
A	A pressione	Press-on
SERRATURA IN ZAMA		DIE CAST BODY
14	Nichelato	Nickel plated
FUNZIONAMENTO		OPERATION
	Rotazione 90° + 90°	Rotating 90° + 90°
USCITA CHIAVE		KEY PULL
2	2 uscite chiave	2 key pull
CORPO CILINDRO Ø 16,5		CYLINDER BODY Ø 16,5
	"L"	"L"
20	mm 20	mm 20
CIFRATURE		KEY-CHANGES
	Senza cilindro	Without cylinder
M	Chiavi differenti sotto chiave maestra	Keyed differently under master-key
A	KA chiavi uguali	KA keyed alike
X	Gruppi di KA	Groups of KA
CHIAVI		KEYS
	Standard	Standard
S	A snodo	Hinged
ACCESSORI IN DOTAZIONE		INCLUDED ACCESSORIES
	1 ghiera	1 ring
CONFEZIONI		PACKAGING
	Commercio 20 pz	Boxed in 20's
I	Industria 100 pz	Bulk in 100's

SERIE
26

26G1 SERRATURA PER CRISTALLO GLASS DOOR LOCK



26G1	26G1	26G1
SERIE	SERIE	SERIES
1	M1	M1
SCATOLA IN ZAMA	SCATOLA IN ZAMA	DIE CAST BODY
6D	Cromo opaco (US26D)	Matt chrome (US26D)
FUNZIONAMENTO	FUNZIONAMENTO	OPERATION
	Rotazione 180°	Rotating 180°
USCITA CHIAVE	USCITA CHIAVE	KEY PULL
2	2 uscite chiave	2 key pull
CIFRATURE	CIFRATURE	KEY-CHANGES
M	Chiavi differenti sotto chiave maestra	Keyed differently under master-key
A	KA chiavi uguali	KA keyed alike
X	Gruppi di KA	Groups of KA
CHIAVE	CHIAVE	KEY
	Standard	Standard
ACCESSORI	ACCESSORI	ACCESSORIES
	1 controbordo + 1 guarnizione	1 striking plate + 1 gasket
CONFEZIONE	CONFEZIONE	PACKAGING
I	Commercio 20 pz Industria 100 pz	Boxed in 20's Bulk in 100's

26G4 SERRATURA PER CRISTALLO GLASS DOOR LOCK



26G4	26G4	26G4
SERIE	SERIE	SERIES
1	M1	M1
SCATOLA IN ZAMA	SCATOLA IN ZAMA	DIE CAST BODY
6D	Cromo opaco (US26D)	Matt chrome (US26D)
FUNZIONAMENTO	FUNZIONAMENTO	OPERATION
	Rotazione 180°	Rotating 180°
USCITA CHIAVE	USCITA CHIAVE	KEY PULL
2	2 uscite chiave	2 key pull
CIFRATURE	CIFRATURE	KEY-CHANGES
M	Chiavi differenti sotto chiave maestra	Keyed differently under master-key
A	KA chiavi uguali	KA keyed alike
X	Gruppi di KA	Groups of KA
CHIAVE	CHIAVE	KEY
	Standard	Standard
ACCESSORI	ACCESSORI	ACCESSORIES
	1 controbordo + 1 guarnizione	1 striking plate + 1 gasket
CONFEZIONE	CONFEZIONE	PACKAGING
I	Commercio 20 pz Industria 100 pz	Boxed in 20's Bulk in 100's



POMOLINO PRATIKO CON CILINDRO PRATIKO KNOB WITH CYLINDER CORES

SERIE
26

26GPOM98	Pomolino PRATIKO Zama	PRATIKO knob Die cast
	SERIE Senza cilindro M1	SERIES Without cylinder core M1
1		
	FINITURE Nickel opaco Cromo opaco	FINISHES Matt nickel Matt chrome
15 6D		
	FUNZIONAMENTO Rotazione 180°	OPERATION Rotating 180°
	USCITA CHIAVE 2 uscite chiave	KEY PULL 2 key pull
2		
	CIFRATURE Senza cilindro Chiavi differenti sotto chiave maestra KA chiavi uguali Gruppi di KA	KEY-CHANGES Without cylinder Keyed differently under master-key KA keyed alike Groups of KA
M A X		
	CHIAVI Standard A snodo	KEYS Standard Hinged
S		
	CONFEZIONI STANDARD 100 pz	STANDARD PACKAGING Boxed in 100's



POMOLINO PRATIKO FISSO FIXED PRATIKO KNOB

26GPOM98F	Pomolino PRATIKO fisso Zama	Fixed PRATIKO knob Die cast
	FINITURE Nichel opaco Cromo opaco	FINISHES Matt nickel Matt chrome
15 6D		
	CONFEZIONI STANDARD 100 pz	STANDARD PACKAGING Boxed in 100's

SERIE
26

26GPAD CILINDRO LUCCHETTABILE PADLOCKABLE CYLINDER



26GPAD	Lucchettabile* Zama + Plastica	Pad-lock* Die cast + Plastic
14	FINITURE CORPO Nichelato lucido	BODY FINISHES Nickel plated
GR	FINITURE INSERTO Grigio RAL 7011	INSERT FINISHES Grey RAL 7011
	CILINDRO "L"	CYLINDER "L"
	Solo impugnatura	Only knob
20	Gruppo monoblocco mm 20	mm 20
25	Gruppo monoblocco mm 25	mm 25
30	Gruppo monoblocco mm 30	mm 30
	LEVETTE Senza levetta	CAMS Without cam
35	Piana A35	Flat A35
	CONFEZIONI 100 pz	PACKAGING Boxed in 100's

*Lucchetto non incluso

*Padlock not included

CILINDRI CYLINDER CORES

SERIE
26



26GCIL	26GCIL	26GCIL
SERIE	SERIE	SERIES
M1	M1	M1
CIFRATURE	CIFRATURE	KEY CHANGES
M	Chiavi differenti sotto chiave maestra	Keyed differently under master-key
A	KA chiavi uguali	KA keyed alike
X	Gruppi di KA	Groups of KA
CHIAVI	CHIAVI	KEYS
	Standard	Standard
S	A snodo	Hinged
FINITURA CILINDRO	FINITURA CILINDRO	CYLINDER FINISH
14	Nichelato	Nickel plated
NE	Nero	Black



26GCIL	26GCIL	26GCIL
SERIE	SERIE	SERIES
M1	M1	M1
CIFRATURE	CIFRATURE	KEY CHANGES
M	Chiavi differenti sotto chiave maestra	Keyed differently under master-key
A	KA chiavi uguali	KA keyed alike
X	Gruppi di KA	Groups of KA
CHIAVI	CHIAVI	KEYS
S	1 a snodo / 1 fissa nichelata	1 hinged / 1 fixed nickel plated
FINITURA IMPUGNATURA	FINITURA IMPUGNATURA	HANDGRIP FINISH
BO	A snodo bianca	Hinged white
NE	A snodo nera	Hinged black
6D	A snodo US6D	Hinged US6D
FINITURA CILINDRO	FINITURA CILINDRO	CYLINDER FINISH
N	Nichel lucido	Polish nickel

SERIE 26

info e preventivi
<http://www.bellittiserrature.it/contact.asp>

APPLICAZIONI SPECIALI ***SPECIAL APPLICATIONS***

info e preventivi
<http://www.bellittiserrature.it/contact.asp>



2710 SERRATURA PER CRISTALLO GLASS DOOR LOCK

SERIE
27

2710	2710	2710
	CORPO (zama)	BODY (die cast)
14	Nichelato (US14)	Nickel plated (US14)
	FUNZIONAMENTO	OPERATION
	Rotazione 90°	Rotating 90°
	CATENACCIO	BOLT
20	mm 20	mm 20
	CIFRATURA	KEY-CHANGE
	KD chiavi differenti 6 cifrature	KD keyed differently 6 key changes
A	KA chiavi uguali	KA keyed alike
	FINITURA	FINISH
	Nichelato (US14)	Nickel plated (US14)
	CONFEZIONE	PACKAGING
	Commercio 20 pz	Boxed in 20's



2751 SERRATURA UNIVERSALE "LUCCHETTABILE" PADLOCKABLE CAM LOCK

2751	2751	2751
	CORPO (zama)	BODY (die cast)
	FUNZIONAMENTO	OPERATION
B	Rotazione 90° Destro	Rotating 90° Right
	POMOLO FISSO	FIXED KNOB
	Zama	Die cast
	FINITURA	FINISH
N	Nichelato	Nickel plated
	CILINDRO	CYLINDER
20	mm 20	mm 20
	ACCESSORI	ACCESSORIES
	1 rondella Art.885	1 washer Art.885
R	Senza rondella	Without washer
	LEVETTA	CAM
	Tipo A	Type A
L	Senza levetta	Without cam
	CONFEZIONI	PACKAGING
I	Industria 100 pz	Bulk in 100's

SERIE
27

2772 SERRATURA UNIVERSALE IN ZAMA DIE CAST CAM LOCK



2772	2772 senza chiave	2772 without key
	FUNZIONAMENTO Rotazione 90°	OPERATION Rotating 90°
	FINITURA Nichelato	FINISH Nickel plated
20	CILINDRO mm 20	CYLINDER mm 20
	APPLICAZIONE Quadri elettrici	APPLICATION Switch board
	ACCESSORI 1 rondella 1 rondella dentellata interna	ACCESSORIES 1 washer 1 internal tooth washer
L	LEVETTA Senza levetta Tipo A35	CAM Without cam Type A35
	CONFEZIONE Commercio 20 pz Industria 100 pz	PACKAGING Boxed in 20's Bulk in 100's



29G5 MANIGLIA PER ANTE METALLICHE METAL DOOR HANDLE

SERIE
29

29G5	29G5	29G5
	CORPO (zama)	BODY (die cast)
	FUNZIONAMENTO Rotazione 90° (2 uscite chiave)	OPERATION Rotating 90° (2 key pull)
	CIFRATURA KD chiavi differenti KA chiavi uguali	KEY-CHANGE KD keyed differently KA keyed alike
A	CHIAVE 2 chiavi con copertura	KEY 2 key with cover
	FINITURA Cromo lucido (US26)	FINISH Polish chrome (US26)
	ACCESSORI 1 rondella in polimero 1 rondella piana 1 rondella dentellata interna	ACCESSORIES 1 polymer washer 1 flat washer 1 internal tooth washer
	LEVETTA 1 levetta piana L.C.Q. mm 50 1 levetta con perni per aste	CAM 1 flat cam L.C.Q. mm 50 1 cam with pins for bars
I	CONFEZIONE Industria multipla 10 pz	PACKAGING Bulk in 10's



29GM MANIGLIA PER ANTE METALLICHE METAL DOOR HANDLE

29GM	29GM	29GM
	CORPO (zama)	BODY (die cast)
	FUNZIONAMENTO Rotazione 90°	OPERATION Rotating 90°
	FINITURA Cromo lucido (US26)	FINISH Polish chrome (US26)
	ACCESSORI 1 rondella in polimero 1 rondella piana 1 rondella dentellata intena	ACCESSORIES 1 polymer washer 1 flat washer 1 internal tooth washer
	LEVETTA 1 levetta piana L.C.Q. mm 50 1 levetta con perni per aste	CAM 1 flat cam L.C.Q. 1 mm 50 1 cam with pins for bars
I	CONFEZIONE Industria multipla 10 pz	PACKAGING Bulk in 10's

SERIE
29

2910 SERRATURA PER CRISTALLO GLASS LOCK



2910	2910	2910
	CORPO (zama)	BODY (die cast)
	FUNZIONAMENTO	OPERATION
	Rotazione 180° (2 uscite chiave)	Rotating 180° (2 key pull)
	APPLICAZIONE	APPLICATION
	Spessore mm 7	Thickness mm 7
B	Spessori fino a mm 7	Thickness up to mm 7
	FINITURA	FINISH
	Cromo lucido (US26)	Polish chrome (US26)
	CIFRATURA	KEY-CHANGE
	KD chiavi differenti	KD keyed differently
A	KA chiavi uguali	KA keyed alike
	CHIAVE	KEY
	2 chiavi con impugnatura	2 key with cap
	CONFEZIONE	PACKAGING
	Commercio 20 pz	Boxed in 20's



CILINDRI A SPINE RADIALI
RADIAL PIN TUMBLER CYLINDER

info e preventivi
<http://www.bellittiserrature.it/contact.asp>



3324 SERRATURA PER SCORREVOLI SLIDING DOOR LOCK

SERIE
33

3324	3324	3324
	FUNZIONAMENTO	OPERATION
	Rotazione 120° (2 uscite chiave)	Rotating 120° (2 key pull)
	CIFRATURA	KEY-CHANGE
	KD chiavi differenti	KD keyed differently
A	KA chiavi uguali	KA keyed alike
X	..x.. KA gruppi di KA	..x.. KA KA in group
	CHIAVE	KEY
	Art.1833 senza tacca (2 pz)	Art.1833 without position refer. (2 pcs)
	FINITURA	FINISHES
26	Cromo lucido (US26)	Polish chrome (US26)
	CILINDRO Ø 22	CYLINDER Ø 22
25	mm 25	mm 25
	ACCESSORI	ACCESSORIES
	1 ghiera Art.1722	1 ring Art.1722
	1 bussola controbordo Art.851	1 striking plate socket Art.851
	1 viti mm 2,9 x 13	2 screw mm 2,9 x 13
	CONFEZIONE	PACKAGING
I	Industria 100 pz	Bulk in 100's

SERIE
33

3351 SERRATURA UNIVERSALE CAM LOCK



3351	3351 cilindro mm 16	3351 cylinder mm 16
	CILINDRO Ø M19	CYLINDER Ø M19
16	mm 16	mm 16
21	mm 21	mm 21
26	mm 26	mm 26
31	mm 31	mm 31
	FUNZIONAMENTO	OPERATION
9D	Rotazione 90° Destro	Rotating 90° Right
18	Rotazione 180° Destro e Sinistro	Rotating 180° Right and Left
	USCITA CHIAVE	KEY PULL
2	2 uscite chiave	2 key pull
1	1 uscita chiave	1 key pull
	CIFRATURA	KEY-CHANGE
	KD chiavi differenti	KD keyed differently
A	KA chiavi uguali	KA keyed alike
X	...x.. KA gruppi di KA	...x.. KA KA in group
M	MK chiave maestra	MK master key
	CHIAVE	KEY
	Art.1833 con tacca (2 pz)	Art.1833 with position refer. (2 pcs)
	FINITURA	FINISH
	Cromo lucido (US26)	Polish chrome (US26)
	LEVETTA	CAM
	Piana A0	Flat A0
L	Senza levetta	Without cam
	CONFEZIONE	PACKAGING
	Commercio 20 pz	Boxed in 20's
I	Industria 100 pz	Bulk in 100's

3355 SERRATURA INTERRUOTTORE SWITCH LOCK



3355	3355/11 ÷ 21	3355/11 ÷ 21
	FUNZIONE	OPERATION
11	11-interruttore monopolare bistabile-1 uscita ch.	11-SPST maintaining contact switch-1 key pull
13	13-interruttore monopolare bistabile-2 uscite ch.	13-SPST maintaining contact switch-2 key pull
21	21-interruttore monopolare monostabile-1 uscita ch.	21-SPST momentary contact switch-1 key pull
41	41-deviatore-1 uscita ch.	41-SPDT maintaining contact switch-1 key pull
43	43-deviatore-2 uscite ch.	43-SPDT maintaining contact switch-2 key pull
51	51-doppio interrut. monopolare bistabile-1 uscita ch.	51-double SPST maintaining contact switch-1 key pull
55	55-doppio interrut. monopolare bistabile-2 uscite ch.	55-double SPST maintaining contact switch-1 key pull
	CIFRATURA	KEY-CHANGE
	KD chiavi differenti	KD keyed differently
A	KA chiavi uguali	KA keyed alike
X	...x.. KA gruppi di KA	...x.. KA KA in group
	CHIAVE	KEY
	Art.1833 con tacca (3 pz)	Art.1833 with position refer. (3 pcs)
	FINITURA	FINISH
	Cromo lucido (US26)	Polish chrome (US26)
	CONFEZIONE	PACKAGING
I	Industria 100 pz	Bulk in 100's



3380 UFO

SERIE
33

3380	3380	3380
	FUNZIONAMENTO	OPERATION
	Rotazione 90° (1 uscita chiave)	Rotating 90° (1 key pull)
	CIFRATURA	KEY-CHANGE
	KD chiavi differenti	KD keyed differently
A	KA chiavi uguali	KA keyed alike
X	... KA gruppi di KA	... KA KA in group
	CHIAVE	KEY
	Art.1833 senza tacca (3 pz)	Art.1833 without position refer. (3 pcs)
	FINITURA	FINISH
15	Nichelato opaco (US15)	Matt nickel (US15)
	CONFEZIONE	PACKAGING
	Singola 1 pz	Single 1 pcs

ACCESSORI PER UFO UFO ACCESSORIES



3381A KIT LUCCHETTO PER UFO PADLOCK KIT FOR UFO

3381A	Kit lucchetto per UFO	Padlock kit for UFO
	FINITURA	FINISH
15	Nichelato opaco (US15)	Matt nickel (US15)
	ACCESSORI	ACCESSORIES
	2 mezze piastre	2 half plates
	2 viti M6x50	2 screw M6x50
	2 dadi	2 nuts
	10 rondelle	10 washer
	CONFEZIONE	PACKAGING
	Singola 1 pz	Single 1 pcs

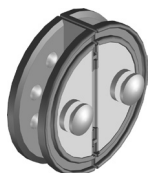

3381GL KIT PER VETRO BASIC KIT FOR GLASS

3381GL	Kit per vetro	Basic kit for glass
	FUNZIONE	OPERATION
	Standard	Standard
p	Fori passanti	
	FINITURA	FINISH
2B	Acciaio inox satinato	Satin stainless steel
	CONFEZIONE	PACKAGING
	Singola 1 pz	Single 1 pcs

SERIE
33

3388 LUCCOTTO
LUCCOTTO



3388	3388	3388
	FUNZIONAMENTO	OPERATION
	Rotazione 90° (1 uscita chiave)	Rotating 90° (1 key pull)
	FINITURE	FINISH
	Cromo lucido (US26)	Polish chrome (US26)
BU	Rivestito blu	Blue polymer covered
NE	Rivestito nero	Black polymer covered
RO	Rivestito rosso	Red polymer covered
	STELO	BAS SIZE
12	Ø mm 12	Ø mm 12
	LUCE	BAR LENGTH
22	mm 22	mm 22
36	mm 36	mm 36
	CIFRATURA	KEY-CHANGE
	KD chiavi differenti	KD keyed differently
A	KA chiavi uguali	KA keyed alike
X	..x.. KA gruppi di KA	..x.. KA KA in group
	CHIAVE	KEY
	Art.1833 senza tacca (3 pz)	Art.1833 without position refer. (3 pcs)
	CONFEZIONE	PACKAGING
	Blister in scatola da 10 pz	Individual blister into 10's box
I	Industria 50 pz	Bulk in 50's



33N7 CILINDRO PER MANIGLIE CYLINDER FOR HANDLE

SERIE
33

33N7	33N7	33N7
	NUCLEO Acciaio temperato	NUCLEO Hardened steel
	FISSAGGIO Autoaggancio	FIXING Self-fixing
	FUNZIONAMENTO Rotazione 90° (1 uscita chiave)	OPERATION Rotating 90° (1 key pull)
	CIFRATURA KD chiavi differenti KA chiavi uguali ...x.. KA gruppi di KA MK chiave maestra (solo mm 30+5)	KEY-CHANGE KD keyed differently KA keyed alike ...x.. KA KA in groups MK master key (only mm 30+5)
	CHIAVE Art.1833 senza tacca (2 pz)	KEY Art.1833 without position refer. (2 pcs)
	DIMENSIONE mm 30 mm 30+5 (chiave maestra)	SIZE mm 30 mm 30+5 (master key)
	CONFEZIONE I Industria 50 pz	PACKAGING Bulk in 50's



3369 NUCLEO OMOLOGATO TÜV-CNPP "NUCLEO" APPROVED TÜV-CNPP

3369	3369	3369
	NUCLEO Acciaio temperato	NUCLEO Hardned steel
	TERMINALE Tipo A Tipo B Tipo C	BACK PART Type A Type B Type C
	FISSAGGIO SB Con foro per spinatura CB Con autoaggancio	FIXING With fixing hole Self-fixing
	ROTAZIONE Libera	ROTATION Free rotation
	USCITA CHIAVE 1 uscita chiave	KEY PULL 1 key pull
	CIFRATURA KD chiavi differenti KA chiavi uguali ...x.. KA gruppi di KA	KEY-CHANGE KD keyed differently KA keyed alike ...x.. KA KA in group
	CHIAVE Art.1833 senza tacca (2 pz)	KEY Art.1833 without position refer. (2 pcs)
	CONFEZIONE I Industria 100 pz	PACKAGING Bulk in 100's

SERIE
33

SERIE
33

CHIAVI
KEYS

1833

3H1833

Chiave grezza

Acciaio

Blank key

Steel

CT

TIPO

Con tacca

ST

Senza tacca

TYPE

With position refer.

Without position refer.

N

MARCHIO

Meroni

Neutro

..

Del cliente

LOGO

Meroni

Neutral

Customer logo

GR

CIFRATURA

Grezza

KEY-CHANGE

Blank

A

KD chiavi differenti

KD keyed differently

KA chiavi uguali

KA keyed alike

FINITURA

Nichelato

FINISH

Nickel plated



IP 33

3IP33

Impugnatura

Polimero

Key cover

Polymer

BU

COLORE

Nero

Blu

COLOUR

Black

Blue

GO

Giallo

Yellow

RO

Rosso

Red

AZ

Azzurro

Light blue

VE

Verde

Green

W

Bianco

White

CONFEZIONE

100 pz

PACKAGING

100 pcs



ACCESSORI ***ACCESSORIES***

info e preventivi
<http://www.bellittiserrature.it/contact.asp>

ACCESSORI PER SERRATURE AD ASTE ROTANTI ACCESSORIES FOR ESPAGNOLETTE LOCKS

SERIE
O

833



O833

Asta laminata

Acciaio

Laminated bar

Steel

FINITURA

Grezzo

FINISH

Rough

N

Nichelato (extra al dm)

Nickel plated (extra dm)

BT

Verniciato nero (extra al dm)

Black coating (extra dm)

LUNGHEZZA

1000

cm 100

LENGTH

cm 100

1400

cm 140 (2 fori)

cm 140 (2 fori)

CONFEZIONE

50 pz

PACKAGING

Boxed in 50's

Misure speciali minimo 300 pz

Minimum special sizes, 300 pcs

837



O837

Asta rotante

Acciaio

Rotating bar

Steel

COLORE TUBETTO

B

Marrone

COVER COLOUR

Brown

NE

Nero

Black

W

Bianco

White

LUNGHEZZA

1000

cm 100

LENGTH

cm 100

1300

cm 130

cm 130

1600

cm 160

cm 160

2000

cm 200

cm 200

CONFEZIONE

50 pz

PACKAGING

Boxed in 50's

Misure speciali minimo 300 pz

Minimum special sizes, 300 pcs

SERIE
O

ACCESSORI PER SERRATURE AD ASTE ROTANTI ACCESSORIES FOR ESPAGNOLETTE LOCKS

837 N

O837	Asta rotante Acciaio	Rotating bar Steel
N	FINITURA Nichelato	FINISH Nickel plated
1000	LUNGHEZZA cm 100	LENGTH cm 100
1300	cm 130	cm 130
1600	cm 160	cm 160
2000	cm 200	cm 200
	CONFEZIONE 50 pz	PACKAGING Boxed in 50's
	Misure speciali minimo 300 pz	Minimum special sizes, 300 pcs

837 OA



O837	Asta rotante Acciaio	Rotating bar Steel
OA	FINITURA Ottone antico	FINISH Antique brass
1000	LUNGHEZZA cm 100	LENGTH cm 100
1300	cm 130	cm 130
1600	cm 160	cm 160
	CONFEZIONE 50 pz	PACKAGING Boxed in 50's
	Misure speciali minimo 300 pz	Minimum special sizes, 300 pcs

837 OT

O837	Asta rotante Acciaio	Rotating bar Steel
OT	FINITURA Ottonato	FINISH Brass plated
1000	LUNGHEZZA cm 100	LENGTH cm 100
1300	cm 130	cm 130
1600	cm 160	cm 160
	CONFEZIONE 50 pz	PACKAGING Boxed in 50's
	Misure speciali minimo 300 pz	Minimum special sizes, 300 pcs

ACCESSORI PER SERRATURE AD ASTE ROTANTI ACCESSORIES FOR ESPAGNOLETTE LOCKS

SERIE
O

281

OASTAC837



Asta rotante
Acciaio grezzo

Rotating bar
Rough steel

1000
1300
1600
2000

LUNGHEZZA

cm 100
cm 130
cm 160
cm 200

LENGTH

cm 100
cm 130
cm 160
cm 200

--

CONFEZIONE

50 pz

PACKAGING

Boxed in 50's

Misure speciali minimo 300 pz

Minimum special sizes, 300 pcs

282

OTUBO837



Copertura per asta
Polimero

Bar cover
Polymer

B
NE
W

COLORE

Marrone
Nero
Bianco

COLOUR

Brown
Black
White

1000
1100
1300
1400
1600

LUNGHEZZA

cm 100
cm 110
cm 130
cm 140
cm 160

LENGTH

cm 100
cm 110
cm 130
cm 140
cm 160

SERIE
O

ACCESSORI PER SERRATURE AD ASTE ROTANTI ACCESSORIES FOR ESPAGNOLETTE LOCKS

872

O872



1

2

N

OA

OT

Gancio a pressione

Zama-Polimero

FUNZIONAMENTO

N.1 destro/sinistro

N.2 destro/sinistro

FINITURA

Nichelato

Ottone antico

Ottonato

CONFEZIONE

50 pz

Press-on hook

Die cast-Polymer

OPERATION

No.1 right/left

No.2 right/left

FINISH

Nickel plated

Antique brass

Brass plated

PACKAGING

Boxed in 50's

872 BIS

O872B



1

2

N

OA

OT

Gancio a vite

Zama-Polimero

FUNZIONAMENTO

N.1 destro/sinistro

N.2 destro/sinistro

FINITURA

Nichelato

Ottone antico

Ottonato

CONFEZIONE

50 pz

Screw-on hook

Die cast-Polymer

OPERATION

No.1 right/left

No.2 right/left

FINISH

Nickel plated

Antique brass

Brass plated

PACKAGING

Boxed in 50's

873

O873



N

OA

OT

Cavallo a pressione

Zama-Polimero

FINITURA

Nichelato

Ottone antico

Ottonato

CONFEZIONE

100 pz

Press-on saddle

Die cast-Polymer

FINISH

Nickel plated

Antique brass

Brass plated

PACKAGING

Boxed in 100's

873 BIS

O873B



N

OA

OT

Cavallo a vite

Zama-Polimero

FINITURA

Nichelato

Ottone antico

Ottonato

CONFEZIONE

100 pz

Screw-on saddle

Die cast-Polymer

FINISH

Nickel plated

Antique brass

Brass plated

PACKAGING

Boxed in 100's

ACCESSORI PER SERRATURE AD ASTE ROTANTI ACCESSORIES FOR ESPAGNOLETTE LOCKS

SERIE
O

872/R

O872R

Gancio a pressione

Zama-Polimero

Press-on hook

Die cast-Polymer

FUNZIONAMENTO

N.1 destro/sinistro

N.2 destro/sinistro

OPERATION

No.1 right/left

No.2 right/left

FINITURA

Nichelato

FINISH

Nickel plated

CONFEZIONE

50 pz

PACKAGING

Boxed in 50's



1

2

N

872/R BIS

O872RB

Gancio a vite

Zama-Polimero

Screw-on hook

Die cast-Polymer

FUNZIONAMENTO

N.1 destro/sinistro

N.2 destro/sinistro

OPERATION

No.1 right/left

No.2 right/left

FINITURA

Nichelato

FINISH

Nickel plated

CONFEZIONE

50 pz

PACKAGING

Boxed in 50's



1

2

N

873/R

O873R

Cavallotto a pressione

Zama-Polimero

Press-on saddle

Die cast-Polymer

FINITURA

Nichelato

FINISH

Nickel plated

CONFEZIONE

100 pz

PACKAGING

Boxed in 100's



N

873/R BIS

O873RB

Cavallotto a vite

Zama-Polimero

Screw-on saddle

Die cast-Polymer

FINITURA

Nichelato

FINISH

Nickel plated

CONFEZIONE

100 pz

PACKAGING

Boxed in 100's



N

SERIE
O

ACCESSORI PER SERRATURE AD ASTE ROTANTI ACCESSORIES FOR ESPAGNOLETTE LOCKS

875

O875



1

2

N

OT

Gancio a pressione

Zama

FUNZIONAMENTO

N.1 destro/sinistro

N.2 destro/sinistro

FINITURA

Nichelato

Ottonato

CONFEZIONE

100 pz

Press-on hook

Die cast

OPERATION

No.1 right/left

No.2 right/left

FINISH

Nickel plated

Brass plated

PACKAGING

Boxed in 100's

875 BIS

O875B



1

2

N

OT

Gancio a vite

Zama-Acciaio

FUNZIONAMENTO

N.1 destro/sinistro

N.2 destro/sinistro

FINITURA

Nichelato

Ottonato

CONFEZIONE

100 pz

Screw-on hook

Die cast-Steel

OPERATION

No.1 right/left

No.2 right/left

FINISH

Nickel plated

Brass plated

PACKAGING

Boxed in 100's

876

O876



N

OT

Cavallo a pressione

Zama

FINITURA

Nichelato

Ottonato

CONFEZIONE

100 pz

Press-on saddle

Die cast

FINISH

Nickel plated

Brass plated

PACKAGING

Boxed in 100's

876 BIS

O876B



N

OT

Cavallo a vite

Zama

FINITURA

Nichelato

Ottonato

CONFEZIONE

100 pz

Screw-on saddle

Die cast

FINISH

Nickel plated

Brass plated

PACKAGING

Boxed in 100's

ACCESSORI PER SERRATURE AD ASTE ROTANTI ACCESSORIES FOR ESPAGNOLETTE LOCKS

SERIE
O

877

O877



1

2

N

OT

Gancio a pressione

Zama-Polimero

FUNZIONAMENTO

N.1 destro/sinistro

N.2 destro/sinistro

FINITURA

Nichelato

Ottonato

CONFEZIONE

50 pz

Press-on hook

Die cast-Polymer

OPERATION

No.1 right/left

No.2 right/left

FINISH

Nickel plated

Brass plated

PACKAGING

Boxed in 50's

877 BIS

O877B



1

2

N

OT

Gancio a vite

Zama-Polimero

FUNZIONAMENTO

N.1 destro/sinistro

N.2 destro/sinistro

FINITURA

Nichelato

Ottonato

CONFEZIONE

50 pz

Screw-on hook

Die cast-Polymer

OPERATION

No.1 right/left

No.2 right/left

FINISH

Nickel plated

Brass plated

PACKAGING

Boxed in 50's

SERIE
O

ACCESSORI PER SERRATURE AD ASTE ROTANTI ACCESSORIES FOR ESPAGNOLETTE LOCKS

855



O855

Gancio a pressione

Polimero

Press-on hook

Polymer

1

FUNZIONAMENTO

N.1 destro/sinistro

OPERATION

No.1 right/left

2

N.2 destro/sinistro

No.2 right/left

B

COLORE

Marrone

COLOUR

Brown

NE

Nero

Black

W

Bianco

White

CONFEZIONE

50 pz

PACKAGING

Boxed in 50's

855 BIS



O855B

Gancio a vite

Polimero

Screw-on hook

Polymer

1

FUNZIONAMENTO

N.1 destro/sinistro

OPERATION

No.1 right/left

2

N.2 destro/sinistro

No.2 right/left

B

COLORE

Marrone

COLOUR

Brown

NE

Nero

Black

W

Bianco

White

CONFEZIONE

50 pz

PACKAGING

Boxed in 50's

856



O856

Cavallo a pressione

Polimero

Press-on saddle

Polymer

B

COLORE

Marrone

COLOUR

Brown

NE

Nero

Black

W

Bianco

White

CONFEZIONE

50 pz

PACKAGING

Boxed in 50's

856 BIS



O856B

Cavallo a vite

Polimero

Screw-on saddle

Polymer

B

COLORE

Marrone

COLOUR

Brown

NE

Nero

Black

W

Bianco

White

CONFEZIONE

50 pz

PACKAGING

Boxed in 50's

ACCESSORI PER SERRATURE AD ASTE ROTANTI ACCESSORIES FOR ESPAGNOLETTE LOCKS

SERIE
O

398

OGRA398

Gruppo accessori in metallo a pressione

Metal accessories kit press-on

1 gancio 609T n.1
 1 gancio 609T n.2
 2 cavallotti 876Q
 2 perni 858
 2 bussole 857

1 hook 609T no.1
 1 hook 609T no.2
 2 saddles 876Q
 2 pins 858
 2 socket 857

PERNO

PIN

Con bussole OBUSSM611
 Centrale O858DQ
 Regolabili O858C16Q

With socket OBUSSM611
 Central pin O858DQ
 Adjustable O858C16Q

FINITURA

FINISH

Bronzato
 Nichelato
 Nero
 Ottonato
 Ottone antico

Bronze plated
 Nickel plated
 Black
 Brass plated
 Antique brass

1

Con fermantina O807

With angle plates O807



398R

OGRA398R

Gruppo accessori in polimero a pressione

Polymer accessories kit press-on

1 gancio 609TR1 n.1
 1 gancio 609TR2 n.2
 2 cavallotti 605P
 2 perni O858BQ

1 hook 609TR1 no.1
 1 hook 609TR2 no.2
 2 saddles 605P
 2 pins O858BQ

PERNO

PIN

Con bussole OBUSSM611
 Centrale O858DQ
 Regolabili O858C16Q

With socket OBUSSM611
 Central pin O858DQ
 Adjustable O858C16Q

COLORE

COLOUR

Marrone
 Nero
 Bianco

Brown
 Black
 White

1

Con fermantina O807

With angle plates O807



SERIE
O

ACCESSORI PER SERRATURE AD ASTE ROTANTI ACCESSORIES FOR ESPAGNOLETTE LOCKS

399

OGRA399

Gruppo accessori in metallo a vite

Metal accessories kit screw-on

1 gancio 609 n.1
 1 gancio 609 n.2
 2 cavallotti 876BQ
 2 perni 858DQ

1 hook 609 no.1
 1 hook 609 no.2
 2 saddles 876BQ
 2 pins 858DQ

PERNO

PIN

Con bussole OBUSSM611
 Centrale O858DQ
 Regolabili O858C16Q

With socket OBUSSM611
 Central pin O858DQ
 Adjustable O858C16Q

FINITURA

FINISH

Bronzato
 Nichelato
 Nero
 Ottonato
 Ottone antico

Bronze plated
 Nickel plated
 Black
 Brass plated
 Antique brass

1

Con fermantina O807

With angle plates O807



399R

OGRA399R

Gruppo accessori in polimero a vite

Polymer accessories kit screw-on

1 gancio 609BR n.1
 1 gancio 609BR n.2
 2 cavallotti 605
 2 perni 858BQ

1 hook 609BR no.1
 1 hook 609BR no.2
 2 saddles 605
 2 pins 858BQ

PERNO

PIN

Con bussole OBUSSM611
 Centrale O858DQ
 Regolabili O858C16Q

With socket OBUSSM611
 Central pin O858DQ
 Adjustable O858C16Q

COLORE

COLOUR

Marrone
 Nero
 Bianco

Brown
 Black
 White

1

Con fermantina O807

With angle plates O807



ACCESSORI PER SERRATURE AD ASTE ROTANTI ACCESSORIES FOR ESPAGNOLETTE LOCKS

SERIE
O

OGRA855

OGRA855

Gruppo accessori 855 in polimero

1 gancio 855 n.1
1 gancio 855 n.2
2 cavallotti 856
2 bussole 857
2 perni 858

Accessories kit 855 polymer

1 hook 855 no.1
1 hook 855 no.2
2 saddles 856
2 socket 857
2 pin 858

FISSAGGIO

A pressione
A vite

FIXING

Press-on
Screw-on

PERNO

Perno centrale 858/A
Perno eccentrico 858/B
Perno regolabile 858/C
Perno eccentrico 858/D

PIN

Central pin 858/A
Eccentric pin 858/B
Adjustable pin 858/C
Eccentric pin 858/D

COLORE

B Marrone
NE Nero
W Bianco

COLOUR

Brown
Black
White



OGRA872

OGRA872

Gruppo accessori 872 in metallo Metal accessories kit 872

1 gancio 872 n.1
1 gancio 872 n.2
2 cavallotti 873
2 perni 858
2 bussole 857

1 hook 872 no.1
1 hook 872 no.2
2 saddles 873
2 pin 858
2 socket 857

FISSAGGIO

A pressione
A vite

FIXING

Press-on
Screw-on

PERNO

Perno centrale 858/A
Perno eccentrico 858/B
Perno regolabile 858/C
Perno eccentrico autofilettante 858/D

PIN

Central pin 858/A
Eccentric pin 858/B
Adjustable pin 858/C
Self-threading eccentric pin 858/D

FINITURA

N Nichelato
OT Ottonato
OA Ottone antico

FINISH

Nickel plated
Brass plated
Antique brass



SERIE
O

ACCESSORI PER SERRATURE AD ASTE ROTANTI ACCESSORIES FOR ESPAGNOLETTE LOCKS

OGRA872R

OGRA872R

Gruppo accessori 872/ridotti in metallo

1 gancio 872/R n.1
 1 gancio 872/R n.2
 2 cavallotti 873/R
 2 perni 858
 2 bussole 857

Accessories kit 872/ slim metal

1 hook 872/R no.1
 1 hook 872/R no.2
 2 saddles 873/R
 2 pin 858
 2 socket 857

A
 B

FISSAGGIO

A pressione
 A vite

FIXING

Press-on
 Screw-on

A
 B
 C
 D

PERNO

Perno centrale 858/A
 Perno eccentrico 858/B
 Perno regolabile 858/C
 Perno eccentrico autofilettante 858/D

PIN

Central pin 858/A
 Eccentric pin 858/B
 Adjustable pin 858/C
 Self-threading eccentric pin 858/D

N

FINITURA

Nichelato

FINISH

Nickel plated



OGRA875

OGRA875

Gruppo accessori 875 in metallo

Metal accessories kit 875

1 gancio 875 n.1
 1 gancio 875 n.2
 2 cavallotti 876
 2 perni 858
 2 bussole 857

1 hook 875 no.1
 1 hook 875 no.2
 2 saddles 876
 2 pin 858
 2 socket 857

B

FISSAGGIO

A pressione
 A vite

FIXING

Press-on
 Screw-on

A
 B
 C
 D

PERNO

Perno centrale 858/A
 Perno eccentrico 858/B
 Perno regolabile 858/C
 Perno eccentrico autofilettante 858/D

PIN

Central pin 858/A
 Eccentric pin 858/B
 Adjustable pin 858/C
 Self-threading eccentric pin 858/D

N
 OT
 OA

FINITURA

Nichelato
 Ottonato
 Ottone antico

FINISH

Nickel plated
 Brass plated
 Antique brass



ACCESSORI PER SERRATURE AD ASTE ROTANTI ACCESSORIES FOR ESPAGNOLETTE LOCKS

SERIE
O

605



O876

Cavallotto

Zama

Saddle

Die cast

FISSAGGIO

A pressione

FIXING

Press-on

A vite

Screw-on

B

FINITURA

Bronzato

FINISH

Bronze plated

Nichelato

Nickel plated

Ottonato

Brass plated

BZQ

NQ

OTQ

OAQ

Ottone antico

Antique plated



605

OCAVAR605

Cavallotto

Polimero

Saddle

Polymer

FISSAGGIO

A vite

FIXING

Screw-on

COLORE

Marrone

COLOUR

Brown

B

Nero

Black

NE

Bianco

White

W



SERIE
O

ACCESSORI PER SERRATURE AD ASTE ROTANTI ACCESSORIES FOR ESPAGNOLETTE LOCKS

609 B

OGRA609B



BZ
N
OT
OA

1
2

Gancio

Zama

FINITURA

Bronzato

Nichelato

Ottonato

Ottone antico

FUNZIONAMENTO

N.1 destro/sinistro

N.2 destro/sinistro

Hook

Die cast

FINISH

Bronze plated

Nickel plated

Brass plated

Antique brass

OPERATION

No.1 right/left

No.2 right/left

609 BR

OGRA609BR



B
NE
W

1
2

Gancio

Polimero

COLORE

Marrone

Nero

Bianco

FUNZIONAMENTO

N.1 destro/sinistro

N.2 destro/sinistro

Hook

Polymer

COLOUR

Brown

Black

White

OPERATION

No.1 right/left

No.2 right/left

609 T

OGRA609T



BZ
N
OT
OA

1
2

Gancio

Zama

FINITURA

Bronzato

Nichelato

Ottonato

Ottone antico

FUNZIONAMENTO

N.1 destro/sinistro

N.2 destro/sinistro

Hook

Die cast

FINISH

Bronze plated

Nickel plated

Brass plated

Antique brass

OPERATION

No.1 right/left

No.2 right/left

ACCESSORI PER SERRATURE AD ASTE ROTANTI ACCESSORIES FOR ESPAGNOLETTE LOCKS

SERIE
O

609 TR



OGRA609TR

B
NE
W

1
2

Gancio

Polimero

COLORE

Marrone

Nero

Bianco

FUNZIONAMENTO

N.1 destro/sinistro

N.2 destro/sinistro

Hook

Polymer

COLOUR

Brown

Black

White

OPERATION

No.1 right/left

No.2 right/left

611/612



OCAVA

611
612



BZ
N
OT
OA

Cavalloetto gancio

Zama

FISSAGGIO

A vite

A pressione

FINITURA

Bronzato

Nichelato

Ottonato

Ottone antico

Saddle hook

Die cast

FIXING

Screw-on

Press-on

FINISH

Bronze plated

Nickel plated

Brass plated

Antique brass

857



O857

M4
M6

Bussola per perno

Polimero bianco

DIMENSIONE

Foro filetto M4 (solo x 858/F)

Foro filetto M6

CONFEZIONE

100 pz

Socket for pin

White polymer

SIZE

Threaded hole M4 (only for 858/F)

Threaded hole M6

PACKAGING

Boxed in 100's

858 A



O858A

Z
BT

Perno centrale

Acciaio

FINITURA

Zincato

Brunito

CONFEZIONE

100 pz

Central pin

Steel

FINISH

Zinc plated

Burnished

PACKAGING

Boxed in 100's

SERIE
O

ACCESSORI PER SERRATURE AD ASTE ROTANTI ACCESSORIES FOR ESPAGNOLETTE LOCKS

858 B



O858B

Perno eccentrico

Zama

FINITURA

Zincato

Brunito

Ottonato

Ottone antico

CONFEZIONE

100 pz

Eccentric pin

Die cast

FINISH

Zinc plated

Burnished

Brass plated

Antique brass

PACKAGING

Boxed in 100's

363



O858

Perno regolabile

Zama

LUNGHEZZA

mm 16

mm 25

mm 32

FINITURA

Zincato

Bronzato

Ottonato

Ottone antico

Adjustable pin

Die cast

LENGTH

mm 16

mm 25

mm 32

FINISH

Zinc plated

Bronza plated

Brass plated

Antique brass

858 C



O858C

Perno regolabile

Zama

FINITURA

Zincato

Brunito

Ottonato

Ottone antico

CONFEZIONE

100 pz

Adjustable pin

Die cast

FINISH

Zinc plated

Burnished

Brass plated

Antique brass

PACKAGING

Boxed in 100's

858 D



O858D

Perno eccentrico autofilettante

Zama

FINITURA

Zincato

Brunito

Ottonato

CONFEZIONE

100 pz

Self-threading eccentric pin

Die cast

FINISH

Zinc plated

Burnished

Brass plated

PACKAGING

Boxed in 100's

858 F



O858F

Perno eccentrico a rullo

Acciaio

FINITURA

Zincato

CONFEZIONE

100 pz

Eccentric pin with roller

Steel

FINISH

Zinc plated

PACKAGING

Boxed in 100's

ACCESSORI PER CHIUSURE MULTIPLE ACCESSORIES FOR MULTIPLE LOCKS

SERIE
O

830



O830

Cavalloetto

Acciaio

FINITURA

Zincato

CONFEZIONE

100 pz

Saddle

Steel

FINISH

Zinc plated

PACKAGING

Boxed in 100's

831



O831

Perno

Polimero-Zama

FINITURA/COLORE

Polimero bianca

Zama zincata

CONFEZIONE

100 pz

Pin

Polymer-Die cast

FINISH/COLOUR

White polymer

Zinc plated die cast

PACKAGING

Boxed in 100's

878R



O878R

Gancio a pressione

Zama-Polimero

FUNZIONAMENTO

1

N.1 destro/sinistro

2

N.2 destro/sinistro

FINITURA

N

Nichelato

CONFEZIONE

50 pz

Press-on hook

Die cast-Polymer

OPERATION

No.1 right/left

No.2 right/left

FINISH

Nickel plated

PACKAGING

Boxed in 50's

878R BIS



O878RB

Gancio a vite

Zama-Polimero

FUNZIONAMENTO

1

N.1 destro/sinistro

2

N.2 destro/sinistro

FINITURA

N

Nichelato

CONFEZIONE

50 pz

Screw-on hook

Die cast-Polymer

OPERATION

No.1 right/left

No.2 right/left

FINISH

Nickel plated

PACKAGING

Boxed in 50's

SERIE
O

ACCESSORI PER CHIUSURE MULTIPLE ACCESSORIES FOR MULTIPLE LOCKS

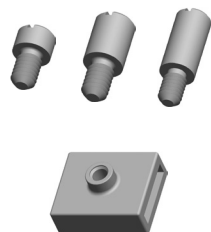

328

OGRA328

Perno regolabile

Zama

Adjustable pin

Die cast

PERNO

404

Filettato M4x4 mm 6

PIN

Threaded pin M4x4 mm 6

408

Filettato M4x8 mm 10

Threaded pin M4x8 mm 10

414

Filettato M4x14 mm 16

Threaded pin M4x14 mm 16

FINITURA

Z

Zincato

FINISH

Zinc plated



582

O842

Asta per art.175

Acciaio

Bar for art.175

Steel

LUNGHEZZA

0500

cm 50

LENGTH

cm 50

0600

cm 60

cm 60

0800

cm 80

cm 80

1000

cm 100

cm 100

FINITURA

Z

Zincato

FINISH

Zinc plated



590

OGRA590

Gruppo accessori per cassettiere

Accessories kit for drawers

ACCESSORI

32

3 perni regolabili-2 cavallotti

ACCESSORIES

3 adjustable pins-2 saddles

42

4 perni regolabili-2 cavallotti

4 adjustable pins-2 saddles

52

5 perni regolabili-2 cavallotti

5 adjustable pins-2 saddles

PERNO

44

Filettato M4x4

PIN

Threaded pin M4x4

48

Filettato M4x8

Threaded pin M4x8

414

Filettato M4x14

Threaded pin M4x14

FINITURA

Z

Zincato

FINISH

Zinc plated

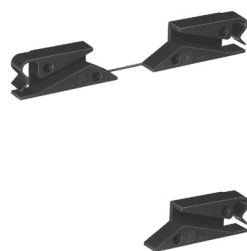

1931

O931

Cuneo antiribaltamento

Polimero

Anti-tilt device

Polymer

FISSAGGIO

A vite

FIXING

Screw-on

COLORE

Nero

COLOUR

Black

CONFEZIONE

R

150 coppie

PACKAGING

Boxed in 150 pairs

Singolo destro

Single right hand

CRICCHETTI MAGNETICI MAGNETIC CATCHES

SERIE
O

906



C906

Magnete

Ferrite di stronzio

POTENZA

Kg 2

COLORE

Nero

CONFEZIONE

Commercio 100 pz
Industria 1000 pz

Magnet

Strontium ferrite

POWER

Kg 2

COLOUR

Black

PACKAGING

Boxed in 100's
Bulk in 1000's

907



C907

Magnete

Ferrite di stronzio

POTENZA

Kg 3

COLORE

Nero

CONFEZIONE

Commercio 100 pz
Industria 1000 pz

Magnet

Strontium ferrite

POWER

Kg 3

COLOUR

Black

PACKAGING

Boxed in 100's
Bulk in 1000's

909



C909

Magnete

Ferrite di stronzio

POTENZA

Kg 4

COLORE

Marrone
Nero
Bianco

CONFEZIONE

Commercio 100 pz
Industria 1000 pz

Magnet

Strontium ferrite

POWER

Kg 4

COLOUR

Brown
Black
White

PACKAGING

Boxed in 100's
Bulk in 1000's

912



C912

Magnete

Ferrite di stronzio

POTENZA

Kg 6

COLORE

Nero

CONFEZIONE

Commercio 100 pz
Industria 1000 pz

Magnet

Strontium ferrite

POWER

Kg 6

COLOUR

Black

PACKAGING

Boxed in 100's
Bulk in 1000's

SERIE
O

CRICCHETTI MAGNETICI MAGNETIC CATCHES

914



C914

Magnete

Ferrite di stronzio

POTENZA

Kg 4

COLORE

Marrone

Bianco

CONFEZIONE

Commercio 100 pz

Industria 1000 pz

Magnet

Strontium ferrite

POWER

Kg 4

COLOUR

Brown

White

PACKAGING

Boxed in 100's

Bulk in 1000's

916



C916

Magnete

Ferrite di stronzio

POTENZA

Kg 6

COLORE

Marrone

Bianco

CONFEZIONE

Commercio 100 pz

Industria 1000 pz

Magnet

Strontium ferrite

POWER

Kg 6

COLOUR

Brown

White

PACKAGING

Boxed in 100's

Bulk in 1000's

925



C925

Magnete

Ferrite di stronzio

POTENZA

Kg 4

COLORI

Marrone

Bianco

CONFEZIONI

Commercio 100 pz

Industria 1000 pz

Magnet

Strontium ferrite

POWER

Kg 4

COLOURS

Brown

White

PACKAGING

Boxed in 100's

Bulk in 1000's

926



C926

Magnete

Ferrite di stronzio

POTENZA

Kg 6

COLORE

Marrone

Bianco

CONFEZIONE

Commercio 100 pz

Industria 1000 pz

Magnet

Strontium ferrite

POWER

Kg 6

COLOUR

Brown

White

PACKAGING

Boxed in 100's

Bulk in 1000's

CRICCHETTI MAGNETICI MAGNETIC CATCHES

SERIE
0

930

C930



Magnete con slitta in polimero

Ferrite di stronzio

POTENZA

Kg 4

COLORE

Marrone

Bianco

CONFEZIONE

Commercio 100 pz

Industria 1000 pz

Magnet with polymer slide

Strontium ferrite

POWER

Kg 4

COLOUR

Brown

White

PACKAGING

Boxed in 100's

Bulk in 1000's

932

C932



Magnete con slitta in metallo

Ferrite di stronzio

POTENZA

Kg 4

COLORE

Marrone

Bianco

CONFEZIONE

Commercio 100 pz

Industria 1000 pz

Magnet with metal slide

Strontium ferrite

POWER

Kg 4

COLOUR

Brown

White

PACKAGING

Boxed in 100's

Bulk in 1000's

SERIE
O

ACCESSORI PER CRICCHETTI MAGNETICI ACCESSORIES FOR MAGNETIC CATCHES

U



OU

Contropiastra

Acciaio

Striking plate

Steel

FINITURA

Zincato

FINISH

Zinc plated

BT

Brunito

Burnished

CONFEZIONE

Commercio 100 pz

PACKAGING

Boxed in 100's

I

Industria 1000 pz

Bulk in 1000's

X



OX

Contropiastra

Acciaio

Striking plate

Steel

FINITURA

Zincato

FINISH

Zinc plated

I

CONFEZIONE

Commercio 100 pz

PACKAGING

Boxed in 100's

I

Industria 1000 pz

Bulk in 1000's

Y



OY

Contropiastra

Acciaio

Striking plate

Steel

FINITURA

Zincato

FINISH

Zinc plated

BT

Brunito

Burnished

CONFEZIONE

Commercio 100 pz

PACKAGING

Boxed in 100's

I

Industria 1000 pz

Bulk in 1000's

Z



OZ

Contropiastra

Acciaio

Striking plate

Steel

DIMENSIONE

Ø mm 12

DIMENSION

Ø mm 12

12

Ø mm 15

Ø mm 15

15

FINITURE

Zincato

FINISH

Zinc plated

I

CONFEZIONE

Commercio 100 pz

PACKAGING

Boxed in 100's

I

Industria 1000 pz

Bulk in 1000's



CRICCHETTI A RULLO ROLLER CATCHES

SERIE
O

999



R999	Cricchetto a rullo Acciaio	Roller catch Steel
	FINITURA Zincato	FINISH Zinc plated
SC	ACCESSORI Senza contropiastra	ACCESSORIES Without striking plate
A	Contropiastra A	Striking plate A
B	Contropiastra B	Striking plate B
C	Contropiastra C	Striking plate C
	CONFEZIONE 100 pz	PACKAGING Boxed in 100's

A



RA	Contropiastra "A" Acciaio	Striking plate "A" Steel
	FINITURA Zincato	FINISH Zinc plated
	CONFEZIONE 1000 pz	PACKAGING Bulk in 1000's

C



RC	Contropiastra "C" Acciaio	Striking plate "C" Steel
	FINITURA Zincato	FINISH Zinc plated
	CONFEZIONE 1000 pz	PACKAGING Bulk in 1000's

SERIE
O

ACCESSORI ACCESSORIES

800



O800

Controbordo

Ottone

Striking plate

Brass

OT

FINITURA

Ferro ottonato

FINISH

Brassed iron

CONFEZIONE

100 pz

PACKAGING

Boxed in 100's

802 T



O802

Controbordo tondo

Acciaio

Round-edge striking plate

Steel

N

FINITURA

Nichelato

FINISH

Nickel plated

OT

Ottonato

Brass plated

CONFEZIONE

100 pz

PACKAGING

Boxed in 100's

807



O807

Controbordo a squadra

Acciaio-Polimero

Square-edge striking plate

Steel-Polymer

Z

FINITURA

Zincato

FINISH

Zinc plated

BT

Brunito

Burnished

OT

Ottonato

Brass plated

R

Polimero

Polymer

CONFEZIONE

100 pz

PACKAG

Boxed in 100's

820



O820

Placca

Acciaio

Plate

Steel

FINITURA

Grezzo

FINISH

Rough

CONFEZIONI

100 pz

PACKAGING

Boxed in 100's

827



O827

Cavallotto

Acciaio

Saddle

Steel

FINITURA

Grezzo

FINISH

Rough

Nichelato

Nickel plated

Ottonato

Brass plated

CONFEZIONE

100 pz

PACKAGING

Boxed in 100's

828



O828

Controbordo

Acciaio

Striking plate

Steel

FINITURA

Grezzo

FINISH

Rough

Nichelato

Nickel plated

Ottonato

Brass plated

CONFEZIONE

100 pz

PACKAGING

Boxed in 100's

390

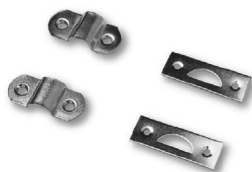

OGRA390

**Gruppo accessori
per serrature a stringa**

**Accessories kit
for pasquill locks**

FINITURA

Grezzo

FINISH

Rough

Nichelato

Nickel plated

Ottonato

Brass plated

806



O806

Bussola controbordo

Polimero

Striking plate socket

Polymer

COLORE

Nero

COLOUR

Black

Grigio

Grey

CONFEZIONE

100 pz

PACKAGING

Boxed in 100's

SERIE
O

ACCESSORI ACCESSORIES

847



O847

Cavallotto

Polimero

COLORE

Nero

Grigio

GR

CONFEZIONE

100 pz

Saddle

Polymer

COLOUR

Black

Grey

PACKAGING

Boxed in 100's

848



O848

Bussola per asta

Polimero

COLORE

Bianco

CONFEZIONE

100 pz

Socket for bar

Polymer

COLOUR

White

PACKAGING

Boxed in 100's

851



O851

Bussola controbordo

Acciaio

FINITURA

4

Ottonato (US4)

14

Nichelato (US14)

BT

Brunito

CONFEZIONE

100 pz

Striking plate socket

Steel

FINISH

Brass plated (US4)

Nickel plated (US14)

Burnished

PACKAGING

Boxed in 100's

864 (per serie 21)



O864

Rondella piana

Acciaio

DIMENSIONE

Ø mm 24

FINITURA

Z

Zincato

BT

Brunito

CONFEZIONE

250 pz

(for locks series 21)

Flat washer

Steel

DIMENSION

Ø mm 24

FINISH

Zinc plated

Burnished

PACKAGING

Boxed in 250's

865 (per serie 21)

(for locks series 21)



O865	Rondella con punte Acciaio	Prongs washer Steel
	DIMENSIONE Ø mm 24	SIZES Ø mm 24
Z	FINITURA Zincato	FINISH Zinc plated
	CONFEZIONE 250 pz	PACKAGING Boxed in 250's

885 (per serie 22-33)

(for locks series 22-33)



O885	Rondella piana Acciaio	Flat washer Steel
	DIMENSIONE Ø mm 28	SIZES Ø mm 28
Z	FINITURA Zincato	FINISH Zinc plated
	CONFEZIONE 100 pz	PACKAGING Boxed in 100's

886 (per serie 22-33)

(for locks series 22-33)



O886	Rondella con punte Acciaio	Prongs washer Steel
	DIMENSIONE Ø mm 28	SIZES Ø mm 28
Z	FINITURA Zincato	FINISH Zinc plated
	CONFEZIONE 100 pz	PACKAGING Boxed in 100's

21LEVA51 (per serie 21-23)

(for locks series 21-23)

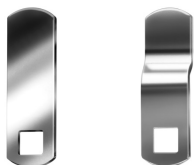

C0	Piana	Flat
C5	Piega mm 5	Bent mm 5
C10	Piega mm 10	Bent mm 10
C15	Piega mm 15	Bent mm 15
Z	FINITURA Zincato	FINISH Zinc plated
	CONFEZIONE 100 pz	PACKAGING Boxed in 100's

3LEVA51 (per serie 22-27-33)

(for locks series 22-27-33)



A0	Piana	Flat
A5	Piega mm 5	Bent 13/64"
A10	Piega mm 10	Bent 25/64"
A15	Piega mm 15	Bent 19/32"
Z	FINITURA Zincato	FINISH Zinc plated
	CONFEZIONI 100 pz	PACKAGING Boxed in 100's

SERIE
O

ACCESSORI ACCESSORIES

CLIP "A"



23CLIPA

Clip "A"

Acciaio

FINITURA

Brunita

CONFEZIONE

200 pz

Clip "A"

Steel

FINISH

Burnished

PACKAGING

Boxed in 200's

CLIP "E"



21CLIFE

Clip "E"

Acciaio

FINITURA

Brunito

CONFEZIONE

250 pz

Clip "E"

Steel

FINISH

Burnished

PACKAGING

Boxed in 250's

CLIP "F"



22CLIFP

Clip "F"

Acciaio

FINITURA

Brunito

CONFEZIONE

100 pz

Clip "F"

Steel

FINISH

Burnished

PACKAGING

Boxed in 100's

1710

O1710



Ghiera

Ottone

FINITURA

Ottonato (US4)

Nichelato (US14)

Brunito

CONFEZIONE

100 pz

Ring

Brass

FINISH

Brass plated (US4)

Nickel plated (US14)

Burnished

PACKAGING

Boxed in 100's

1716

O1716



Ghiera

Acciaio

FINITURA

Ottonato decapato (US4)

Nichelato (US14)

Brunito

CONFEZIONE

100 pz

Ring

Steel

FINISH

Brass plated (US4)

Nickel plated (US14)

Burnished

PACKAGING

Boxed in 100's

1720

O1720



Ghiera

Ottone

FINITURA

Ottonato decapato (US4)

Nichelato (US14)

Brunito

CONFEZIONE

100 pz

Ring

Brass

FINISH

Brass plated (US4)

Nickel plated (US14)

Burnished

PACKAGING

Boxed in 100's

1722

O1722



Ghiera

Ottone

FINITURA

Ottonato decapato (US4)

Nichelato (US14)

Brunito

CONFEZIONE

100 pz

Ring

Brass

FINISH

Brass plated (US4)

Nickel plated (US14)

Burnished

PACKAGING

Boxed in 100's

SERIE
O

ACCESSORI
ACCESSORIES

401



2AGHIE17
N
OT
BZ
NE

Ghiera

Acciaio

FINITURA

Nichelato

Ottonato

Bronzato

Nero

Ring

Steel

FINISH

Nickel plated

Brass plated

Bronze plated

Black

106



ODIS106
NE
W

Distanziale

Polimero

SPESORE

mm 2

COLORE

Nero

Bianco

Spacer

Polymer

THICKNESS

mm 2

COLOUR

Black

White

881



O881
3
GR
NE

Distanziale

Polimero

SPESORE

mm 2

mm 3

COLORE

Grigio

Nero

CONFEZIONE

200 pz

Spacer

Polymer

THICKNESS

mm 2

mm 3

COLOUR

Grey

Black

PACKAGING

Boxed in 200's

882

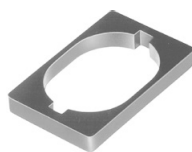

O882
NE

Distanziale

Polimero

SPESORE

mm 3,8

COLORE

Nero

CONFEZIONE

200 pz

Spacer

Polymer

THICKNESS

mm 3,8

COLOUR

Black

PACKAGING

Boxed in 200's

870

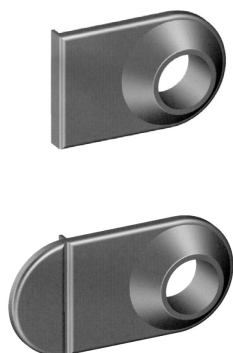

870

CB

15
NE

Rosetta

Polimero

TIPO

Senza battuta

Con battuta

FINITURA E COLORE

Nichel satinato (US15)

Nero

CONFEZIONE

100 pz

Rose

Polymer

TYPE

Without rabbet

With rabbet

FINISH AND COLOUR

Satin nickel (US15)

Black

PACKAGING

Boxed in 100's

870 G



O870G

15

Ghiera per vetro

Polimero

COLORE

Nichel satinato (US15)

Nero

CONFEZIONE

100 pz

Ring for glass

Polymer

COLOUR

Satin nickel (US15)

Black

PACKAGING

100 pz

870 P



870P

SB
CB

15
GR

Rosetta per pomolo 1998

Polimero

TIPO

Senza battuta

Con battuta

FINITURA E COLORE

Nichel satinato (US15)

Grigio

CONFEZIONE

100 pz

Rose for knob 1998

Polymer

TYPE

Without rabbet

With rabbet

FINISH AND COLOUR

Satin nickel (US15)

Grey

PACKAGING

Boxed in 100's

870 PG



O870PG

15
GR

Ghiera vetro per pomolo 1998

Polimero

FINITURA E COLORE

Nichel satinato (US15)

Grigio

CONFEZIONE

100 pz

Ring glass for knob 1998

Polymer

FINISH AND COLOUR

Satin nickel (US15)

Grey

PACKAGING

100 pz

SERIE
O

CHIAVI PER MOBILI FURNITURE KEYS

79



O1679

Chiave
Zama

STELO
mm 36

FINITURA
Nichelato
Bronzato
Ottonato

Key
Die cast

SHANK
mm 36

FINISH
Nickel plated
Bronze plated
Brass plated

80



O1680

Chiave
Zama

STELO
mm 42

FINITURA
Nichelato
Bronzato
Ottonato

Key
Die cast

SHANK
mm 42

FINISH
Nickel plated
Bronze plated
Brass plated

81



O1681

Chiave
Zama

FINITURA
Zincato tropicale

CIFRATURA
Cifratura n.1
Cifratura n.2
Cifratura n.3
Cifratura n.4
Cifratura n.5
Cifratura n.6

Key
Die cast

FINISH
Galvanized tropical

KEY-CHANGE
Key-changes no.1
Key-changes no.2
Key-changes no.3
Key-changes no.4
Key-changes no.5
Key-changes no.6

86



O1686

Chiave
Zama

STELO
mm 42

FINITURA
Bronzato
Nichelato
Ottonato

Key
Die cast

SHANK
mm 42

FINISH
Bronze plated
Nickel plated
Brass plated

91



O1691

Chiave
Zama

Key
Die cast

STELO
mm 42

SHANK
mm 42

BZ
N
OA
OT

FINITURE

Bronzato
Nichelato
Ottone antico
Ottonato

FINISHES

Bronze plated
Nickel plated
Antique brass
Brass plated

92



O1692

Chiave
Zama

Key
Die cast

STELO
mm 42

SHANK
mm 42

F

PASSO

Francese

BIT

French

BZ
FA
N
OA
OT

FINITURA

Bronzato
Ferro antico
Nichelato
Ottone antico
Ottonato

FINISH

Bronze plated
Antique steel
Nickel plated
Antique plated
Brass brass

699



O699

Chiave
Zama

Key
Die cast

STELO
mm 35

SHANK
mm 35

N
OT

FINITURA

Nichelato
Ottonato

FINISH

Nickel plated
Brass plated

I

CONFEZIONE

Commercio 100 pz
Industria 1000 pz

PACKAGING

Boxed in 100's
Bulk in 1000's

1633



O1633

Chiave
Zama

Key
Die cast

STELO
mm 42

SHANK
mm 42

OT

FINITURA

Ottonato

FINISH

Brass plated

I

CONFEZIONE

Commercio 100 pz
Industria 1000 pz

PACKAGING

Boxed in 100's
Bulk in 1000's

SERIE
O

CHIAVI PER CILINDRI CYLINDER KEYS

1804

22H1804



Standard

A
 X

Nichelato

G

Chiave grezza (4 spine)

Ottone

Standard

CIFRATURA

KD chiavi differenti

KA-464 chiavi uguali

... KA gruppi di KA

FINITURA

Nichelato

CONFEZIONE

100 pz

Blank key (4 pins)

Brass

Standard

KEY-CHANGE

KD keyed differently

KA-464 keyed alike

... KA KA in groups

FINISH

Nickel plated

PACKAGING

Boxed in 100's

1823

22H1823



A
 X

Nichelato

G

Chiave grezza (3 spine)

Ottone

CIFRATURA

KD chiavi differenti

KA-1760 chiavi uguali

... KA gruppi di KA

FINITURA

Nichelato

CONFEZIONE

100 pz

Blank key (3 pins)

Brass

KEY-CHANGE

KD keyed differently

KA-1760 keyed alike

... KA KA in groups

FINISH

Nickel plated

PACKAGING

Boxed in 100's

1824

22H1824



A
 X

Nichelato

G

Chiave grezza (4 spine)

Ottone

CIFRATURA

KD chiavi differenti

KA-1271 chiavi uguali

... KA gruppi di KA

FINITURA

Nichelato

CONFEZIONE

100 pz

Blank key (4 pins)

Brass

KEY-CHANGE

KD keyed differently

KA-1271 keyed alike

... KA KA in groups

FINISH

Nickel plated

PACKAGING

Boxed in 100's

82

2BH82



3
 4

A
 X

Nichelato

R

Chiave grezza

Zama

3 spine

4 spine

CIFRATURA

KD chiavi differenti

KA chiavi uguali

... KA gruppi di KA

FINITURA

Nichelato

A stelo

Blank key

Die cast

3 pins

4 pins

KEY-CHANGE

KD keyed differently

KA keyed alike

... KA KA in groups

FINISH

Nickel plated

Leg only

CHIAVI PER CILINDRI CYLINDER KEYS

SERIE
O

82 P10/P11



2BH82	Chiave con impugnatura grezza	Blank key with polymer cover
	Acciaio-Polimero	Steel-Polymer
3	3 spine	3 pins
4	4 spine	4 pins
	CIFRATURA	KEY-CHANGE
A	KD chiavi differenti	KD keyed differently
X	KA chiavi uguali	KA keyed alike
	... KA gruppi di KA	... KA KA in groups
	TIPO	TYPE
P10	Standard	Standard
P11	A snodo	Hinged
	COLORE	COLOUR
NE	Nero	Black
G3	Grigio 3	Grey 3

82 PU



2BG82	Coppia chiavi per UNIKO	Pair of key for UNIKO
	Acciaio-Polimero	Steel-Polymer
3	3 spine	3 pins
4	4 spine	4 pins
	TIPO	TYPE
63	Standard	Standard
	Ribassata	Reduced key
	CIFRATURA	KEY-CHANGE
A	KD chiavi differenti	KD keyed differently
X	KA chiavi uguali	KA keyed alike
	... KA gruppi di KA	KA KA in groups
	COLORE	COLOUR
PUNE	Impugnatura nera	Black Polymer cover
PUG8	Impugnatura grigio 8	Grey 8 Polymer cover
PUBL	Impugnatura blu	Blue Polymer cover
GR	Grezza	Rough

SERIE
O

CHIAVI
KEYS

M1



26H

Chiave grezza con coprichiave grigio

Blank key grey cap

M1

Reversibile con coprichiave grigio
 Ottone, fresata, nichelata

SERIE

Double code with grey plastic cover
 Brass, cut, nickel plated

S

CHIAVE

KEY

Standard

Standard

A

A snodo

Hinged

CC

Profilo CC

PROFILE
 Profile CC

CD

Profilo CD

Profile CD

A

Chiave grezza

KEY CHANGES

Blank key

X

KA chiavi uguali

KA keyed alike

X

Su codice da comunicare

Key number to be notified

M2



26H

Chiave grezza con coprichiave grigio

Blank key grey cap

M2

Reversibile con coprichiave grigio
 Acciaio, tranciata, nichelata

SERIE

Double code with grey plastic cover
 Steel, punched, nickel plated

S

CHIAVE

KEY

Standard

Standard

A

A Snodo

Hinged

A

Chiave grezza

KEY CHANGES

Blank key

X

KA chiavi uguali

KA keyed alike

X

Su codice da comunicare

Key number to be notified

M4



26H

Chiave grezza con coprichiave grigio

Blank key grey cap

M4

Reversibile con coprichiave grigio
 Ottone, fresata laser, profilo a onda,
 nichelata

SERIE

Double code with grey plastic cover
 Brass, laser cut, wave profile, nickel
 plated

S

CHIAVE

KEY

Standard

Standard

A

A Snodo

Hinged

A

Chiave grezza

KEY CHANGES

Blank key

X

KA chiavi uguali

KA keyed alike

X

Su codice da comunicare

Key number to be notified

M6



26H

Chiave grezza con coprichiave grigio

Blank key grey cap

M6

Reversibile con coprichiave grigio
 Ottone, fresata, nichelata

SERIE (*)

Double code with grey plastic cover
 Brass, cut, nickel plated

S

CHIAVE ()**

KEY ()**

Standard

Standard

A

Chiave grezza

KEY CHANGES

Blank key

X

KA chiavi uguali

KA keyed alike

X

Su codice da comunicare

Key number to be notified

CHIAVI RIMOZIONE CILINDRO CYLINDER CORES

SERIE
O

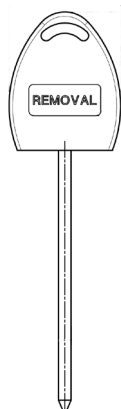

26HR	Chiave rimozione cilindro Solo fissa-coprichiave plastica rossa	Cylinder core removable key Standard only-red plastic key cap
SERIE		
M1	Per serie M1	For M1 series
M2	Per serie M2	For M2 series
M4	Per serie M4	For M4 series
M6	Per serie M6	For M6 series



26CHSGA	Chiave di sgancio per pomolino PRATIKO e cilindro lucchettabile Acciaio-coprichiave plastica rossa	Release key for PRATIKO knob and padlockable cylinder Steel-red plastic cover
----------------	---	--

CHIAVI MAESTRE MASTER KEYS



26H	Chiave maestra Solo fissa-coprichiave plastica blu	Master key Standard only-blue plastic key cap
SERIE		
M1	Per serie M1	For M1 series
TIPO		
MCC	Per profilo CC	For CC profile
MCD	Per profilo CD	For CD profile
G	Generale, per profili CC-CD	General, for CC-CD profiles



26H	Chiave maestra Coprichiave plastica blu	Master key Blue plastic key cap
SERIE		
M2	Per serie M2	For M2 series
M4	Per serie M4	For M4 series
M6	Per serie M6	For M6 series
TIPO		
M	Chiave maestra	Master key

SERIE
O

CHIAVI PER MOBILI FURNITURE KEYS

1860



25H1860

Chiave Box Triangolo

Polimero

FINITURA

Nero

Key Box Triangle

Polymer

FINISH

Black

1862



26H1862

Chiave Box Triangolo

Zama

FINITURA

Nichelato

Key Box Triangle

Die cast

FINISH

Nickel plated

1951



O951

Copriserratura

Polimero

COLORE

Nero

CONFEZIONE

100 pz

Dust cover

Polymer

COLOUR

Black

PACKAGING

Boxed in 100's

POMOLINO PER CILINDRI SERIE 21 KNOBS FOR CYLINDERS SERIES 21

SERIE
O

1997

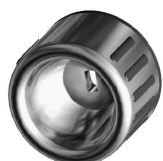

O997

Pomolino

Zama

Knob

Die cast

15GM

NENE

FINITURA E COLORE

Nichelato/Grigio Medio

Nero/Nero

FINISH AND COLOUR

Nickel plated/Grey

Black/Black

CONFEZIONE

100 pz

PACKAGING

Boxed in 100's

1997 F



O997F

Pomolino fisso

Zama

Fixed knob

Die cast

15GM

NENE

FINITURA E COLORE

Nichelato/Grigio Medio

Nero/Nero

FINISH AND COLOUR

Nickel plated/Grey

Black/Black

15

FINITURA FINITO CILINDRO

Nichelato (US15)

DUMMY CYLINDER FINISH

Nickel plated (US15)

CONFEZIONE

100 pz

PACKAGING

Boxed in 100's

1998



O998

Pomolino Forma Combi

Zama-Polimero

Knob Forma Combi

Die cast-Polymer

NA

FINITURA E COLORE

Verniciato argento

FINISH AND COLOUR

Silver coating

CONFEZIONE

100 pz

PACKAGING

Boxed in 100's

1998 F



O998F

Pomolino Forma Combi

Zama-Polimero

Knob Forma Combi

Die cast-Polymer

NA

FINITURA E COLORE

Verniciato argento

FINISH AND COLOUR

Silver coating

CONFEZIONE

100 pz

PACKAGING

Boxed in 100's

SERIE
O

POMOLINO PER CILINDRI KNOBS FOR CYLINDERS

200



O944

Pomolino con inserti

Polimero

Knob with insert

Polymer

G8

COLORE

Grigio 8

COLOUR

Grey 8

NA

Verniciato argento

Silver coating

G8

INSERTO E CHIAVE

Grigio 8

INSERT AND KEY

Grey 8

GF

Grafite

Graphite

NE

Nero

Black

201



O944

Pomolino senza inserti

Polimero

Knob without insert

Polymer

G8

COLORE

Grigio 8

COLOUR

Grey 8

NA

Verniciato argento

Silver coating

202



O944F

Pomolino fisso con inserti

Polimero

Fixed knob with insert

Polymer

G8

COLORE

Grigio 8

COLOUR

Grey 8

NA

Verniciato argento

Silver coating

G8

INSERTO E CHIAVE

Grigio 8

INSERT AND KEY

Grey 8

203



O944FV

Pomolino fisso senza inserti

Polimero

Fixed knob without insert

Polymer

G8

COLORE

Grigio 8

COLOUR

Grey 8

NA

Verniciato argento

Silver coating

G8

FINTA CHIAVE

Grigio 8

DUMMY KEY

Grey 8

ACCESSORI VETRO GLASS ACCESSORIES

SERIE
O

260



O260

Placca

Zama e Plastica

Plate

Die cast and Plastic

SERIE

SERIES

CB

Con battuta

With rabbet

FINITURE

FINISHES

15

Nichelato

Nickel plated

Per Art. 2650

For Art. 2650



260S



O260S

Contropiastra doppia

Zama e Plastica

Double striking plate

Die cast and Plastic

FINITURE

FINISHES

15

Nichelato

Nickel plated

261



O261

Placca

Zama e Plastica

Plate

Die cast and Plastic

SERIE

SERIES

CB

Con battuta

With rabbet

FINITURE

FINISHES

15

Nichelato

Nickel plated

Per Art. 2651

For Art. 2651



26ROND51



26ROND51

Rondella

Plastica

Washer

Plastic

FINITURE

FINISHES

Semi trasparente

Semi transparent

SERIE
O

ACCESSORI ACCESSORIES



810R

O810R

Cavallotto controbordo 2642

Plastica

Saddle-striking plate for 2642

Plastic

FINITURE

Semi trasparente

FINISHES

Semi transparent



840

O840

Cavallotto

Zama

Saddle

Die cast

FINITURE

Nichelato

FINISHES

Nickel plated

N

CONFEZIONI STANDARD

100 pz

STANDARD PACKAGING

Boxed in 100's



846

O846

Cavallotto

Plastica

Saddle

Plastic

COLORI

Grigio chiaro RAL 9006

COLOURS

Light grey RAL 9006

G

CONFEZIONI STANDARD

100 pz

STANDARD PACKAGING

Boxed in 100's

ΔΔ

Peso di 100 pz g 145

Weight of 100's g 145



26DIST30

26DIST30	Distanziatore 2630	Spacer 2630
	Plastica	Plastic
SPESSORE	SPESSORE	THICKNESS
3	mm 3	mm 3
FINITURE	FINITURE	FINISHES
GR	Grigio RAL 7011	Grey RAL 7011



26DIST33

26DIST33	Distanziatore 2633/34	Spacer 2633/34
	Plastica	Plastic
	Standard	Standard
R	Refilato	Refilato
SPESSORE	SPESSORE	THICKNESS
3	mm 3	mm 3
FINITURE	FINITURE	FINISHES
GR	Grigio RAL 7011	Grey RAL 7011
FG	Grigio chiaro PANTONE 6C	Light grey PANTONE 6C



26DIST8687

26DIST8687	Distanziatore 2686/87	Spacer 2686/87
	Plastica	Plastic
	SPESSORE	THICKNESS
	mm 1	mm 1
FINITURE	FINITURE	FINISHES
FG	Grigio chiaro PANTONE 6C	Light grey PANTONE 6C



SERIE
O

ACCESSORI ACCESSORIES



26FECAT30B

26FECAT30B

Fermo catenaccio 2630 BIS

Plastica

Bolt stopper for 2630 BIS

Plastic



26CLIP50

26CLIP50

Clip 2650

Acciaio

Clip 2650

Steel



26CLIP51

26CLIP51

Clip 2651

Acciaio

Clip 2651

Steel



UFO+



UFO



LUCCOTTO

info e preventivi
<http://www.bellittiserrature.it/contact.asp>

UFO+ AUTOMOTIVE UFO+ AUTOMOTIVE

SERIE
80

AUTOMOTIVE



8086H3122B

Singolo KD, Inox
con 2 chiavi reversibili

Single KD, Inox
with 2 reversible keys

8086H3232B

Kit di 2 pezzi KA, Inox
con 3 chiavi reversibili

2 pc's kit KA, Inox
with 3 reversible keys

8086H3332B

Kit di 3 pezzi KA, Inox
con 3 chiavi reversibili

3 pc's kit KA, Inox
with 3 reversible keys

8086H312M2B

Singolo KD sotto MK, Inox
con 2 chiavi reversibili

Single KD under MK, Inox
with 2 reversible keys

8086H323M2B

Kit di 2 pezzi KA sotto MK, Inox
con 3 chiavi reversibili

2 pc's kit KA under MK, Inox
with 3 reversible keys

8086H333M2B

Kit di 3 pezzi KA sotto MK, Inox
con 3 chiavi reversibili

3 pc's kit KA under MK, Inox
with 3 reversible keys

UFO+ ACCESSORI UFO+ ACCESSORIES

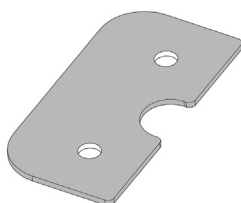

80PISPC86

Piastra spessoramento
controcuneo

Shimmering plate for
wedge

CHH31ALXVE

Copia di chiave cifrata

Copy of coded key



CHH31ALMVE

Copia di chiave cifrata MK

Copy of MK coded key



SERIE
80

UFO AUTOMOTIVE
UFO AUTOMOTIVE



8080331215D	Singolo KD con 2 chiavi	Single KD with 2 keys
8080332315D	Kit di 2 pezzi KA, con 3 chiavi	2 pc's kit KA, with 3 keys
8080333315D	Kit di 3 pezzi KA con 3 chiavi	3 pc's kit KA with 3 keys



8080331215	UFO automotive singolo KD solo calotta	UFO automotive Single KD only shell
8080332315	UFO automotive kit di 2 pezzi KA solo calotte	UFO automotive 2 pc's kit in KA only shells
8080333315	UFO automotive kit di 3 pezzi KA solo calotte	UFO automotive 3 pc's kit in KA only shells

UFO ACCESSORI
UFO ACCESSORIES



8081	Kit flange complete di set di montaggio	Flange kit with complete assembling set
D DS	2 Flange STD 1 Flangia STD + 1 flangia smussata	2 Flanges STD 1 Flange STD + 1 chamfered flange
15	Nichel opaco	Matt nickel
C	CONFEZIONE Singola 1 kit	PACKAGING Single 1 kit



80STA81S15C	Flangia smussata	Chamfered flange
--------------------	------------------	------------------



80PIASP81DX	Piastra di spessoramento	Shimming plate
--------------------	--------------------------	----------------



80H1833CTXAZ	Copia di chiave cifrata IP	Copy of coded key IP
---------------------	----------------------------	----------------------

LUCCOTTO AUTOMOTIVE LUCCOTTO AUTOMOTIVE

SERIE
80



8088223313NE892B

Singolo KD, stelo 22 mm
completo di 1 kit staffe

*Single KD, 22 mm stem
1 complete holders kit*

8088223323NE892B

Coppia KA, stelo 22 mm
completo di 2 kit staffe

*Couple KA, 22 mm stem
2 complete holders kits*



8088363313NE892B

Singolo KD, stelo 36 mm
completo di 1 kit staffe

*Single KD, 36 mm stem
1 complete holders kit*

8088363323NE892B

Coppia KA, stelo 36 mm
completo di 2 kit staffe

*Couple KA, 36 mm stem
2 complete holders kits*

LUCCOTTO ACCESSORI LUCCOTTO ACCESSORIES



8089222B

Kit staffe per 22 mm

Holders kit for 22 mm stem



8089362B

Kit staffe per 36 mm

Holders kit for 36 mm stem

