



**MYA**

**KIUSO**

**STRIP**

**MYA**

**IL PROGRAMMA PIÙ COMPLETO DI  
SISTEMI COORDINATI A FILO MURO**  
*The most complete program about  
coordinated flush with the wall systems*



**IL PROGRAMMA PIÙ COMPLETO DI  
SISTEMI COORDINATI A FILO MURO**  
*The most complete program about coordinated flush  
with the wall systems*

Porte, chiusure e battiscopa a filo muro, prodotti coordinati e complementari all'insegna dell'essenzialità, in grado di svolgere appieno la loro funzione seguendo uno stile contemporaneo, non per forza minimalista. Forme rigorose e pure dove ogni unità funzionale è sapientemente integrata per lasciare spazio alla creatività.

Sistemi pensati per integrarsi perfettamente con la parete fino a fondersi con essa, da personalizzare in infiniti modi e cambiare ogni volta, per bisogno o semplice desiderio.

*Door, locks and skirting flush with the wall, products coordinated and complementary in respect of essentiality, can fully play their role following a contemporary style not minimal necessary. Strict and well forms, where each functional unit is cleverly integrated to allow space to creativity.*

*Systems designed to integrate seamlessly with the wall until it merges with it, to personalize in infinite ways and to change every time, for need or simple desire.*



Cod. **MPC051**, edizione Settembre 2015, ristampa Aprile 2016.

Con lo scopo di migliorare costantemente i propri prodotti, Royal Pat S.r.l. si riserva il diritto di apportare modifiche e varianti senza l'obbligo di preavviso. E' vietata la riproduzione anche parziale del presente catalogo senza espressa autorizzazione scritta da parte di Royal Pat S.r.l. unipersonale.

*With the aim to constantly improve own products, Royal Pat srl reserve the right to make modification and changes without duty of notice. Is interdict the reproduction, even partial, of this catalogue without express written license from Royal Pat srl unipersonale.*



**MYA PORTE / DOORS**

Le porte senza stipiti né coprifili, realizzate nelle tipologie di apertura a battente, scorrevole, pieghevole e bilico. Disponibili nelle versioni da verniciare, già laccate, a vetri e in laminato.

*The doors haven't frames or back lining, made in the opening typologies swing, sliding, folding and pivot. Available in versions to be painted, lacquered already, glass and laminate.*

**BATTENTE REVERSIBILE**  
REVERSIBLE SWING Pag. 4



**PIEGHEVOLE**  
FOLDING Pag. 6



**BILICO UNIDIREZIONALE**  
UNIDIRECTIONAL PIVOT Pag. 8



**BILICO BIDIREZIONALE**  
BIDIRECTIONAL PIVOT Pag. 10



**SCORREVOLE ESTERNO MURO**  
SLIDING EXTERNAL WALL Pag. 12



**SCORREVOLE CENTRO MURO**  
SLIDING CENTER WALL Pag. 14

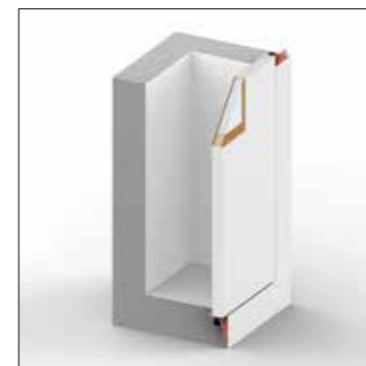

**KIUSO CHIUSURE / LOCKS**

Sistema di chiusure a scomparsa per vani armadio, nicchie e ripostigli di vario genere. Disponibile nella versione da verniciare, già laccate, a vetri e in laminato.

*Hidden locks system for wardrobe rooms, niches and storage rooms of various kinds. Available in versions to be painted, lacquered already, glass and laminate.*

**BATTENTE REVERSIBILE**  
REVERSIBLE SWING Pag. 22



**STRIP BATTISCOPA / SKIRTING**

Sistema battiscopa filomuro disponibile in finitura ox argento e laccato nelle tinte Ral. Il sistema può anche accogliere battiscopa di tipo commerciale e fonti luminose a Led.

*Skirting flush with the wall system available in paintable version, lacquered and in laminate. The system can also accommodate skirting type commercial and led light sources.*

**BATTISCOPA FIOMURO**  
skirting flush with the wall Pag. 24

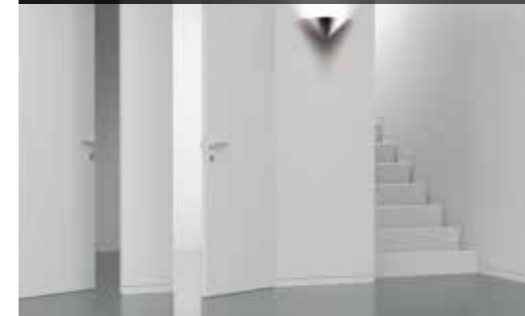



Porte filomuro MYA apertura battente spingere destra e tirare sinistra, telaio senza traverso, anta in finitura laccata Ral 9005 lucido, maniglie Tratto senza foro chiave in finitura argento satinato. Battiscopa filomuro STRIP in finitura laccata Ral 9005 lucido.

Flush to the wall door MYA swing opening push right and pull left, frame without upper crosspiece. Panel in lacquered finish RAL 9005 bright 100 gloss. TRATTO handles without key hole in satin silver finish. Skirting flush with the wall STRIP in lacquered finish Ral 9005 bright 100 gloss.



**MYA, L'ORIGINALE E LA PIU' IMITATA PORTA FILOMURO REVERSIBILE !**  
 MYA, THE ORIGINAL AND MOST IMITATED FLUSH WITH THE WALL REVERSIBLE DOOR!



Economica, versatile e geniale. La installi indistintamente su pareti in muratura o in cartongesso, decidendo il verso di apertura al momento della posa. Un solo articolo che elimina ogni possibilità di errore, sempre disponibile in pronta consegna presso i nostri Partner commerciali (\*).

Economic, versatile and brilliant. The install without distinction of masonry walls or plasterboard, deciding the opening direction at the time of installation. One article that eliminates any possibility of mistake, always available for immediate delivery at our business partners (\*).

(\*) Solo con accessori di serie, altezza Et. 215  
 Only with standard accessories, height Et. 215

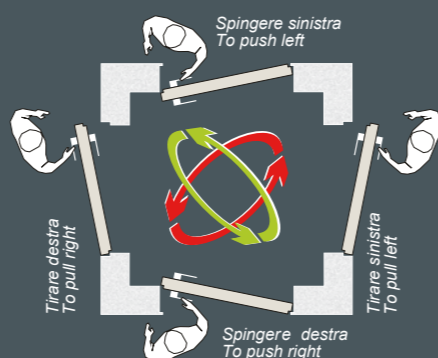

## REVERSIBLE SWING

### DIMENSIONI / DIMENSIONS

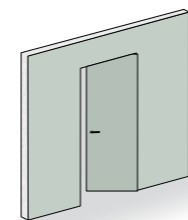

**1A**  
Un'anta  
One panel

	LARGHEZZA / width	ALTEZZA / height
<b>1A standard</b>	Et: 68 - 78 - 88 - 98	215 - 245
<b>1A su misura/customized</b>	Et: fino a/until 108	fino a/until 305
<b>2A standard</b>	Et: 128 - 148 - 168 - 188	215 - 245
<b>2A su misura/customized</b>	Et: fino a/until 208	fino a/until 305

Et = misura d'ordine / order measure

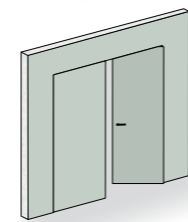

**2A**  
Due ante  
Two panels

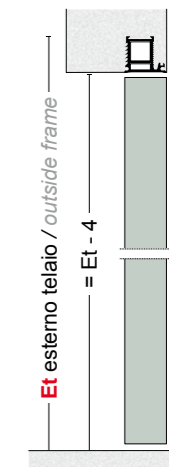
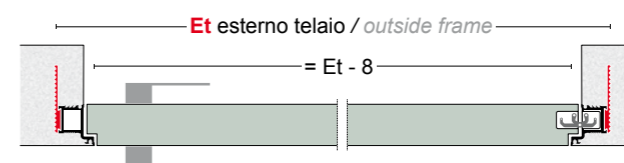

### VERSO DI APERTURA / OPENING DIRECTION

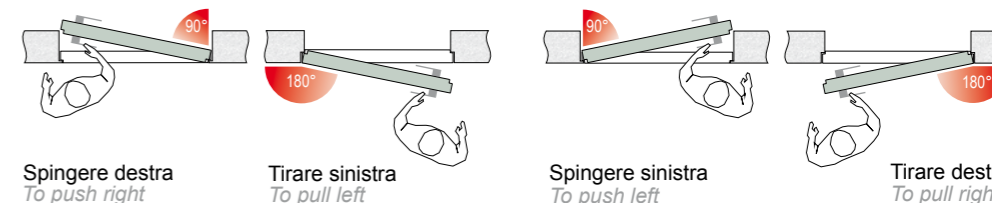

### FORNITURA DI SERIE / SUPPLY OF SERIES

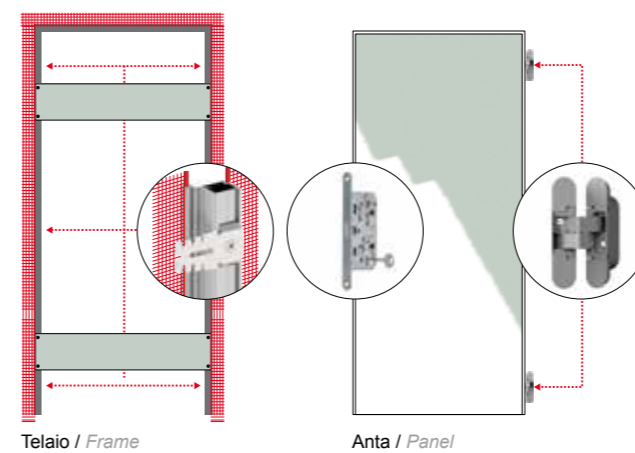

Porta filomuro apertura battente reversibile(\*), applicabile su pareti in muratura e cartongesso di qualsiasi spessore, disponibile nelle misure standard e su misura. La fornitura di serie comprende: telaio in alluminio estruso da 44 mm in finitura ruvida tipo intonaco sovraverniciabile completo di staffe di fissaggio. Anta tamburata rivestita nelle due facce e nei quattro bordi con carta melaminica sovraverniciabile, completa di guarnizione di battuta. Serratura magnetica "patent" (maniglia esclusa) e cerniere registrabili sui 3 assi.

Swing flush with the wall door reversible (\*), can be applied on brick or plastered walls of any thickness, available in standard measures or customized, ready to be painted or covered with decorative paper. The delivery includes: Extruded aluminium frame 44 mm in rough finish completely with fixing brackets, hollowed panel covered and edged, with three side jamb gasket, magnetic lock "patent", hidden hinges (handle not included) adjustable on 3 axes.

(\* ) Porta reversibile solo in altezza Et 215 con telaio da 44 mm, accessori e anta di serie.  
 Reversible only in height 215 with frame 44 mm, accessories and panels as standard.

### PERSONALIZZAZIONI / CUSTOMIZATIONS

 Telaio Filomuro 102 Filomuro 102 frame	 Telaio Centromuro 102 Center-Wall 102 frame	 Telaio senza traverso. Frame without crosspiece.	 Telaio con battuta sup.re Frame with upper swing	 Abbattimento acustico Noise reduction	 Porta obliqua Oblique door
 Ante in finitura Different finish	 Chiusura a molla Spring closer	 Chiusura idraulica Hydraulic closer	 Cerniere a colore Hinges on color	 Chiusure speciali. Special closures.	



## DIMENSIONI / DIMENSIONS

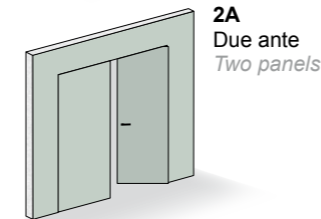
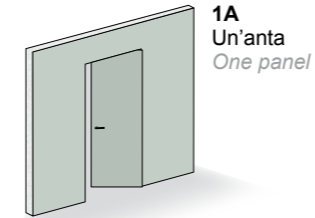

	LARGHEZZA / width	ALTEZZA / height
1A standard	Et: 68 - 78 - 88 - 98	215 - 245
1A su misura /customized	Et: fino a/until 108	fino a/until 245
2A standard	Et: 128 - 148 - 168 - 188	215 - 245
2A su misura /customized	Et: fino a/until 208	fino a/until 245

Et = misura d'ordine / order measure

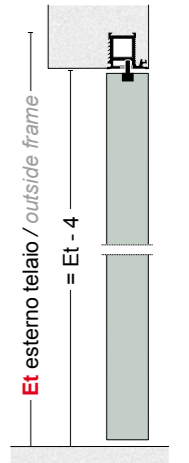
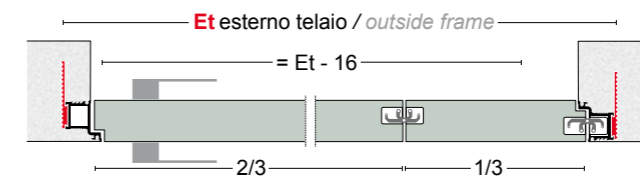

## VERSO DI APERTURA / OPENING DIRECTION

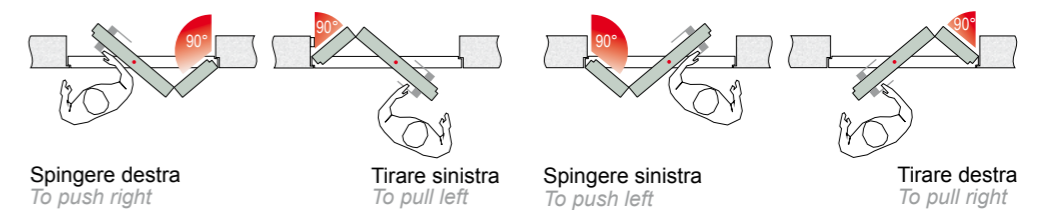

## FORNITURA DI SERIE / SUPPLY OF SERIES

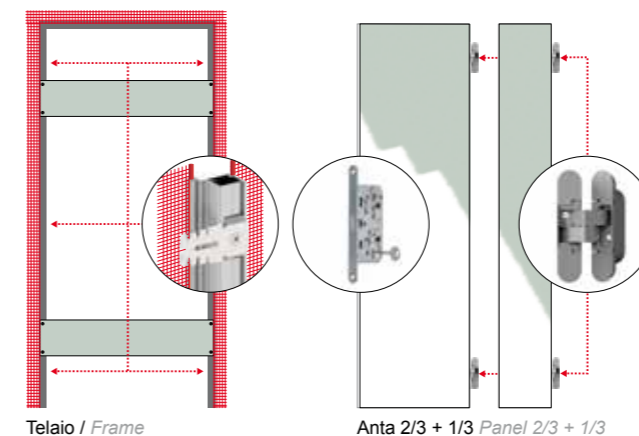

Porta filomuro apertura pieghevole, applicabile su pareti in muratura e cartongesso di qualsiasi spessore, disponibile nelle misure standard e su misura. La fornitura di serie comprende: telaio in alluminio estruso da 44 mm in finitura ruvida tipo intonaco sovraverniciabile completo di staffe di fissaggio. Anta tamburata pieghevole rivestita nelle due facce e nei quattro bordi con carta melaminica sovraverniciabile, completa di guarnizione di battuta. Serratura magnetica "patent" (maniglia esclusa) e cerniere registrabili sui 3 assi.

Folding flush with the wall door, can be applied on brick or plastered walls of any thickness, available in standard measures or customized. The delivery includes: Extruded aluminium frame 44mm in rough finish completely with fixing brackets, hollowed folding panel covered and edged in two faces and four sides with melaminic paper, with jamb gasket, magnetic lock "patent" (handle not included), hidden hinges adjustable on 3 axes.

## PERSONALIZZAZIONI / CUSTOMIZATIONS



Porta filomuro MYA apertura pieghevole spingere sinistra, anta in finitura intonaco, maniglia Tratto in finitura Ral 9010. Sportello filomuro KIUSO apertura battente tirare destra con chiusura a scomparsa push-pull, anta a specchio. A fianco: esempio di installazione porta filomuro con cornici in gesso applicate al perimetro del telaio.

Folding flush with the wall MYA door push left, panel in plaster finish, Tratto handle in RAL 9010 finish. Flush with the wall cage KIUSO opening pull right with push-open system, mirror panel. Next to: example of flush with the wall door application with plaster cornices applied around the frame.

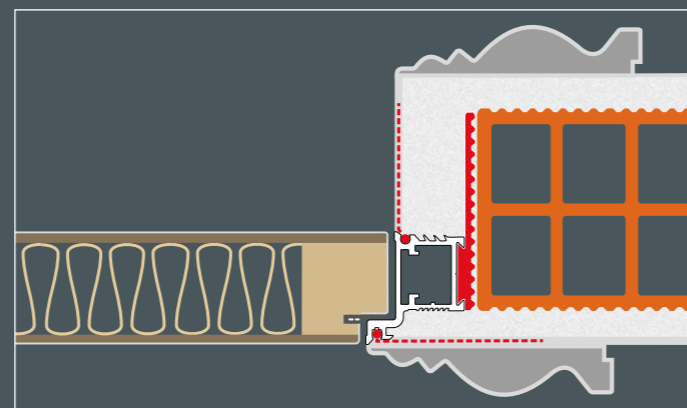





## DIMENSIONI / DIMENSIONS

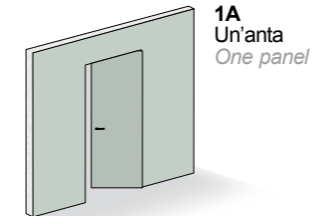

	LARGHEZZA / width	ALTEZZA / height
1A standard	Et: 108 - 118 - 128 - 138	215 - 245
1A su misura/customized	Et: fino a/until 188	fino a/until 305
2A standard	Et: 208 - 228 - 248 - 268	215 - 245
2A su misura/customized	Et: fino a/until 368	fino a/until 305

Et = misura d'ordine / order measure

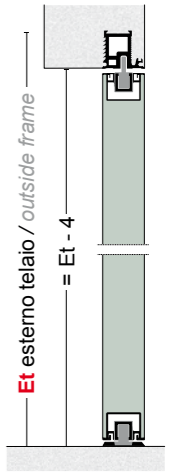
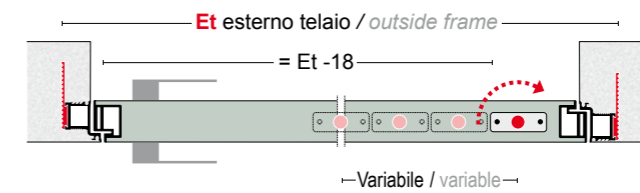
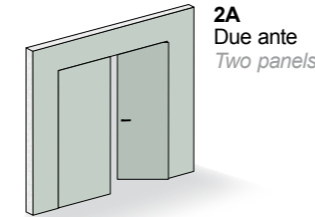

## VERSO DI APERTURA / OPENING DIRECTION

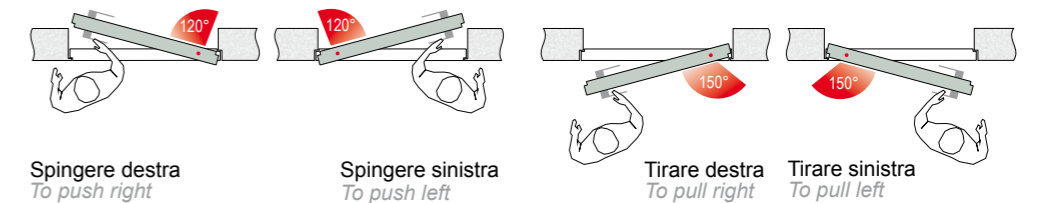

## FORNITURA DI SERIE / SUPPLY OF SERIES

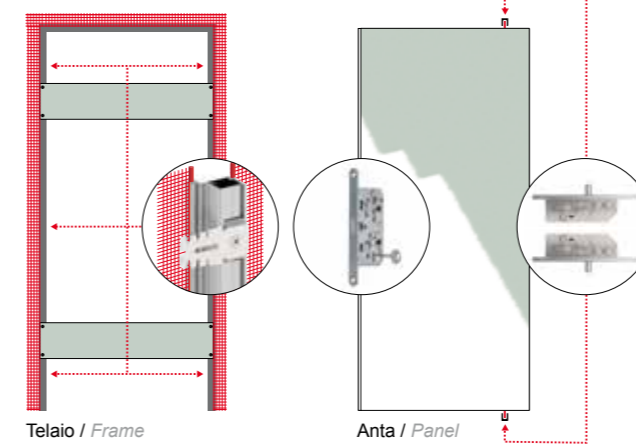

Porta filomuro apertura a bilico unidirezionale, applicabile su pareti in muratura e cartongesso di qualsiasi spessore, disponibile nelle misure standard e su misura. La fornitura di serie comprende: telaio in alluminio estruso da 44 mm in finitura ruvida tipo intonaco sovraverniciabile completo di staffe di fissaggio. Anta tamburata rivestita nelle due facce con carta melaminica e bordi in alluminio sovraverniciabile, completa di guarnizione di battuta. Serratura magnetica "patent" (maniglia esclusa) e perni di rotazione superiore e inferiore.

*Pivot flush with the wall, can be applied on brick or plastered walls of any thickness, available in standard measures or customized. The delivery includes: Extruded aluminium frame 44mm in rough finish completely with fixing brackets, hollowed panel covered in the two faces with melaminic paper and with aluminium edges paintable, with jamb gasket. Magnetic lock "patent" (handle not include), upper and lower rotation pivot.*

## PERSONALIZZAZIONI / CUSTOMIZATIONS

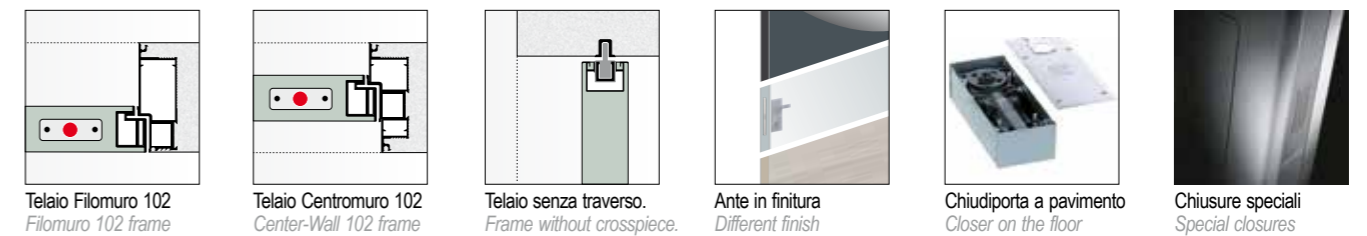

Porta filomuro MYA apertura a bilico unidirezionale tirare destra, anta in finitura intonaco, maniglia Tratto senza foro chiave in finitura Ral 1013.  
A fianco: esempio di apertura anta a bilico unidirezionale con perno di rotazione laterale e centrale.

*Flush with the wall door MYA pull right. Frame in plaster finish. Tratto handle without key hole in RAL1013 finish.  
Next to: example of unidirectional pivot opening with lateral and central rotation pivot.*

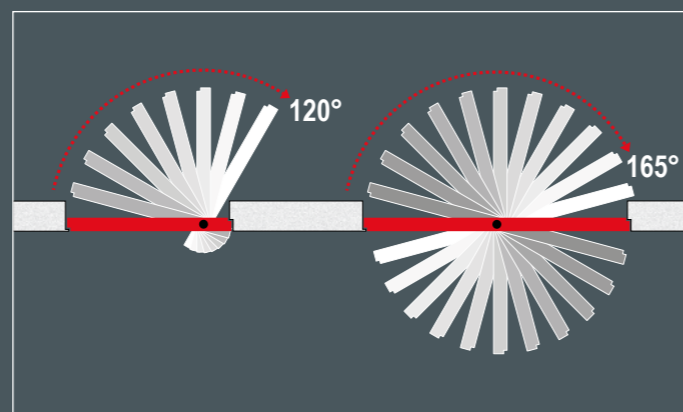



## DIMENSIONI / DIMENSIONS

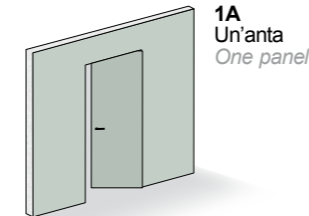

	LARGHEZZA / width	ALTEZZA / height
1A standard	Et: 108 - 118 - 128 - 138	215 - 245
1A su misura/customized	Et: fino a/until 188	fino a/until 305
2A standard	Et: 208 - 228 - 248 - 268	215 - 245
2A su misura/customized	Et: fino a/until 368	fino a/until 305

Et = misura d'ordine / order measure

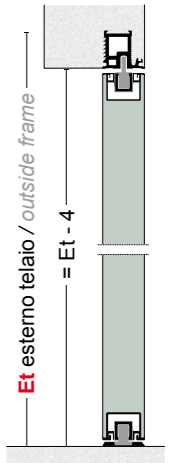
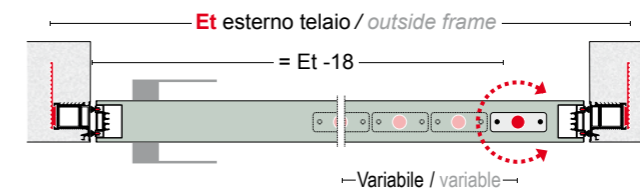
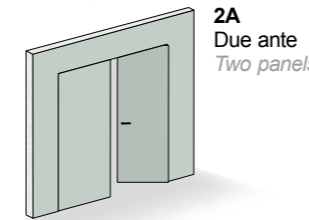

## VERSO DI APERTURA / OPENING DIRECTION



Spingere e tirare destra  
To push and to pull right

Spingere e tirare sinistra  
To push and to pull left

## FORNITURA DI SERIE / SUPPLY OF SERIES

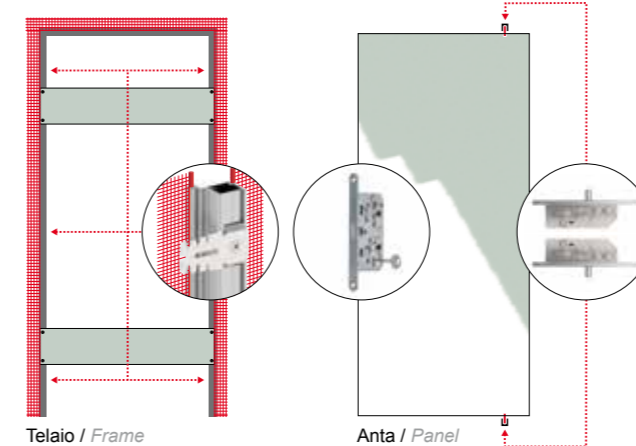

Porta filomuro apertura a bilico bidirezionale, applicabile su pareti in muratura e cartongesso di qualsiasi spessore, disponibile nelle misure standard e su misura. La fornitura di serie comprende: telaio in alluminio estruso da 44 mm in finitura ruvida tipo intonaco sovraverniciabile completo di staffe di fissaggio. Anta tamburata rivestita nelle due facce con carta melaminica e bordi in alluminio sovraverniciabile, completa di guarnizioni a spazzola. Serratura magnetica "patent" (maniglia esclusa) e perni di rotazione superiore e inferiore.

Coming and going flush with the wall door, can be applied on brick or plastered walls of any thickness, available in standard measures or customized. The delivery includes: Extruded aluminium frame 44mm in rough finish completely with fixing brackets, hollowed panel covered in the two faces with melaminic paper and with aluminium edges paintable, completely with brush gasket, magnetic lock "patent" (handle not include), upper and lower rotation pivot.

## PERSONALIZZAZIONI / CUSTOMIZATIONS

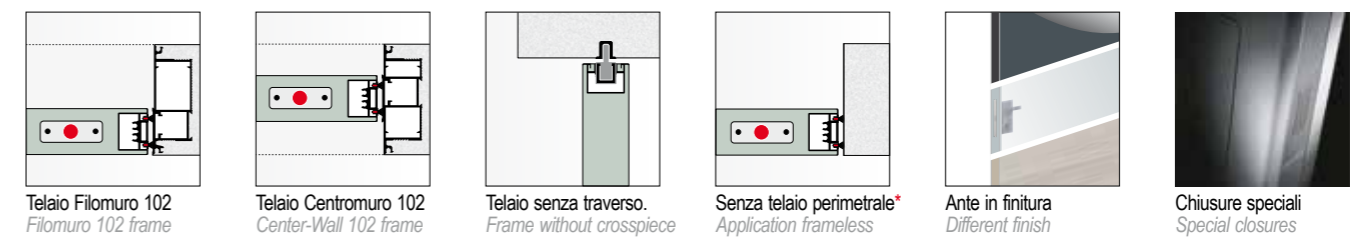

\* La realizzazione senza telaio non prevede la serratura  
The frameless application is without lock

Porta filomuro MYA apertura a bilico bidirezionale senza telaio perimetrale, anta in finitura intonaco, senza serratura e maniglia. A fianco: esempio di apertura anta bilico bidirezionale con perno di rotazione laterale e centrale.

Pivot flush with the wall MYA door without perimetral frame, panel in plaster finish, without lock and handle. Next to: example of bidirectional pivot opening with lateral and central rotation pivot.

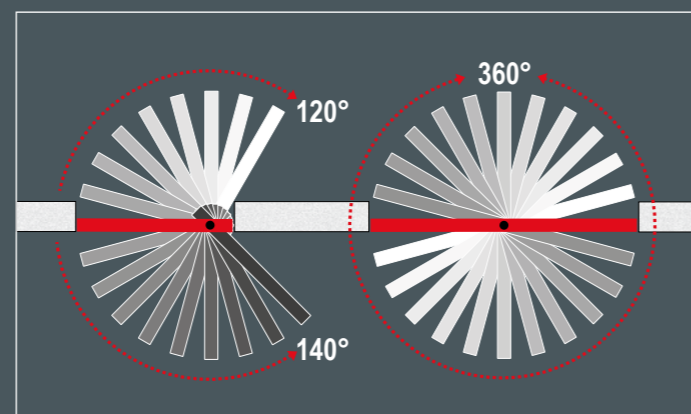



# MYA SCORREVOLE ESTERNO MURO

Porta filoparete MYA scorrevole esterno muro apertura scorrevole sinistra, anta in finitura intonaco, maniglia Tratto S in finitura Ral 3000. Battiscopa filomuro STRIP in finitura laccato Ral 9016 opaco.

Flush with the wall MYA sliding external wall door sliding opening left, panel in plaster finish, Tratto S handle in Ral 3000 finish. Skirting Flush STRIP lacquered finish RAL 9016 matt.

## CHOOSE YOUR LOOK



**SCORREVOLE ESTERNO MURO, pura, libera e leggera, si muove silenziosa sfiorando la parete.**

Un connubio perfetto tra design e funzionalità. Libera da binari e travi di scorrimento a vista per un elemento puro da ogni dettaglio. L'apertura è sospesa, la porta si muove silenziosa con leggerezza sfiorando la parete, senza svelare il proprio funzionamento. Un brevetto esclusivo MYA di avanzata tecnologia che non ingombra e si monta facilmente.

**SLIDING EXTERNAL WALL, pure, light and free, it moves silently touching the wall.**

A perfect combination of design and functionality. Free from track and sliding beam to have a pure element. Opening is suspended, the door moves silently touching the wall, without reveal its functioning. An exclusive MYA patent with advanced technology that not cluttered and you can fix easily.



# SLIDING EXTERNAL WALL



## DIMENSIONI / DIMENSIONS

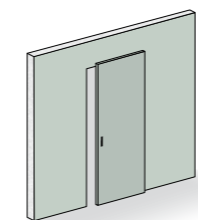

**1A**  
Un'anta  
One panel

	LARGHEZZA / width	ALTEZZA / height
1A standard	Et: 68 - 78 - 88 - 98	215 - 245
1A su misura/customized	Et: fino a/until 138	fino a/until 305
2A standard	Et: 128 - 148 - 168 - 188	215 - 245
2A su misura/customized	Et: fino a/until 268	fino a/until 305

Et = misura d'ordine / order measure

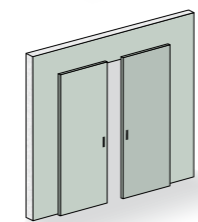

**2A**  
Due ante  
Two panels

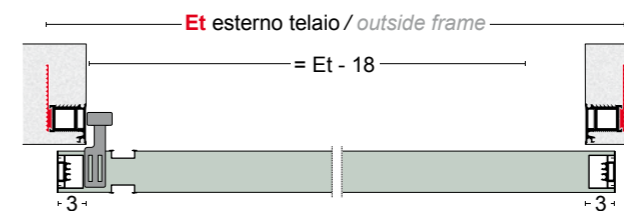

## VERSO DI APERTURA / OPENING DIRECTION

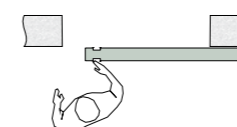

Spingere destra  
To push right

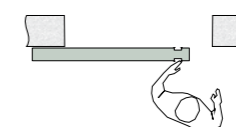

Spingere sinistra  
To pull left

## FORNITURA DI SERIE / SUPPLY OF SERIES

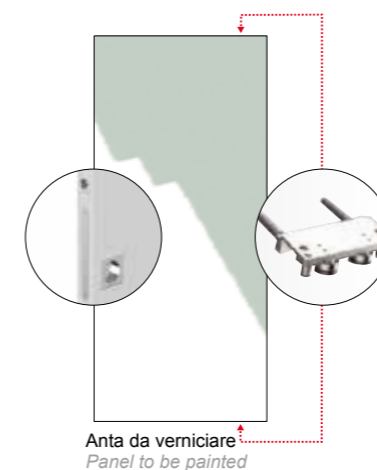

Anta da verniciare  
Panel to be painted

Porta scorrevole esterno muro con apertura senza binari a vista, applicabile su pareti in muratura e cartongesso di qualsiasi spessore, disponibile nelle misure standard e su misura. La fornitura di serie comprende: telaio in alluminio estruso da 44 mm in finitura ruvida tipo intonaco sovraverniciabile completo di staffe di fissaggio e accessori di montaggio. Anta tamburata rivestita nelle due facce con carta melaminica e bordi in alluminio sovraverniciabile. Maniglie ad incasso quadrata in finitura cromo satinato (serratura esclusa).

External from the wall sliding door without visible track, can be applied on brick or plastered walls of any thickness, available in standard measures or customized. The delivery includes: Extruded aluminium frame 44mm in rough finish completely with fixing brackets, hollowed panel covered in the two faces with melaminic paper and with aluminium edges paintable. Recessed handles square in satin finish (lock not included).

## PERSONALIZZAZIONI / CUSTOMIZATIONS



Ante in finitura  
Different finish



Chiusure speciali  
Special closures



Con il nuovo telaio "centromuro", la porta battente può convivere nello stesso ambiente della porta scorrevole senza manifestare tutta la sua diversità.

With new "centromuro" frame, the swing door can cohabit in the same ambient with the sliding one without show its diversity.

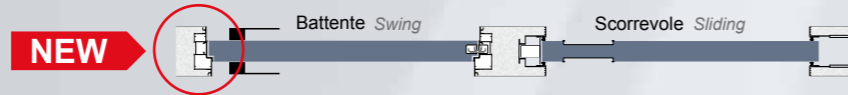

A sinistra: sportelli filomuro KIUSO apertura battente tirare sinistra con chiusura a scomparsa push-pull, anta in finitura laccato Ral 5010 opaco il primo e con vetro trasparente gli altri due.  
Al centro: porta filomuro MYA apertura battente spingere destra con nuovo telaio centro-muro, anta in finitura laccata Ral 5010 opaco, maniglia Tratto senza foro chiave.  
A destra: porta centromuro MYA apertura scorrevole all'interno del muro spingere destra, anta in finitura laccata Ral 5010 opaco, maniglia Tratto S.

On the left: flush with the wall cage KIUSO opening pull left with push-open system, panel in lacquered RAL 5010 mat the first and with transparent glasses the other two.  
At the center: Flush with the wall MYA door push right with new center-wall frame, panel in lacquered RAL 5010 mat, Tratto handle without key hole.  
On the right: center-wall MYA door with sliding inside the wall push right opening, panel in lacquered RAL 5010 mat, Tratto S handle.



## DIMENSIONI / DIMENSIONS

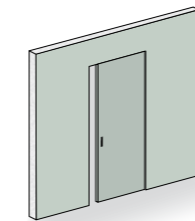

1A  
Un'anta  
One panel

	LARGHEZZA / width	ALTEZZA / height
1A standard	Et: 60 - 70 - 80 - 90	210 - 240
1A su misura/customized	Et: fino a/until 120	fino a/until 260
2A standard	Et: 120 - 140 - 160 - 180	210 - 240
2A su misura/customized	Et: fino a/until 240	fino a/until 260

Et = misura d'ordine / order measure

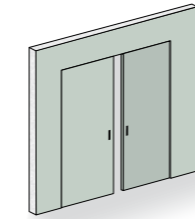

2A  
Due ante  
Two panels

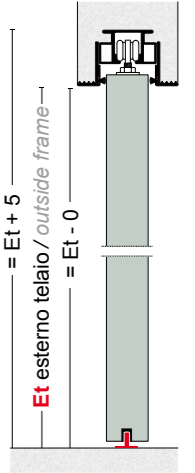
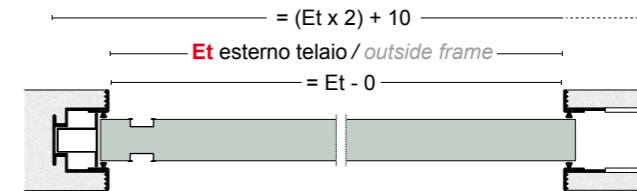

## VERSO DI APERTURA / OPENING DIRECTION



Spingere destra  
To push right

Spingere sinistra  
To pull left

## FORNITURA DI SERIE / SUPPLY OF SERIES

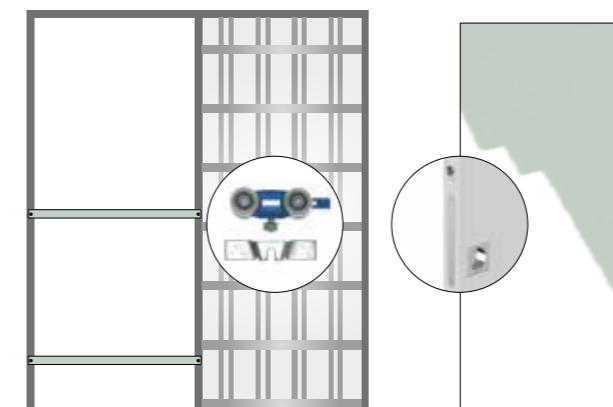

Telaio / Frame

Anta / Panel

Porta centro muro con apertura scorrevole reversibile, applicabile su pareti in muratura o cartongesso rispettivamente di spessore 105/125 mm e 100/125. La fornitura di serie comprende: cassonetto a scomparsa in metallo versione muratura o cartongesso, completo di carrelli e accessori di montaggio. Anta tamburata rivestita nelle due facce e nei quattro bordi con carta melaminica sovraverniciabile. Doppia maniglia ad incasso quadrata in finitura cromo satinato (serratura esclusa).

Center wall with sliding reversible opening, can be applied on brick or 102mm thickness plastered walls. The delivery includes: metallic concealed pelmet in wall or plaster version, completely with trolley and assembled accessories, hollowed panel covered in two faces and four edges with paintable melaminic paper. Recessed handles square in satin finish (lock not included).

## PERSONALIZZAZIONI / CUSTOMIZATIONS



Ante in finitura  
Different finish



Chiusure speciali  
Special closures



Porta filomuro MYA apertura battente spingere destra, anta doppio vetro satinato bianco con bordo anta in alluminio in finitura ox argento (altri colori Ral a richiesta), maniglia Tratto in finitura argento satinato.  
Battiscopa filomuro STRIP in finitura Ral 7011

Flush with the wall swing MYA door opening push right, double satin white glass panel with aluminium edge in silver finish (other Ral colors on demand), Tratto handle in satin silver finish.  
Skirting Flush STRIP finish Ral 7011

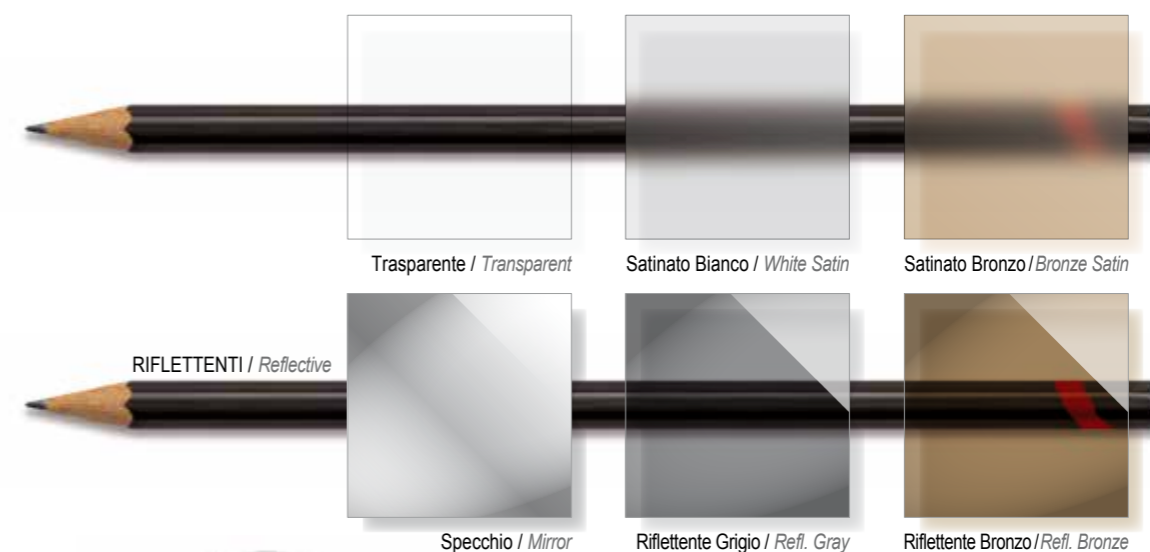

## GLASS



Le tinte della presente cartella sono puramente indicative / The colors of this chart are indicative.





Porta filomuro MYA apertura battente tirare destra, anta in finitura laminato CPL frassino bianco FB01 con maniglia Tratto in finitura Ral 9007 senza foro chiave.  
Battiscopa filomuro STRIP in finitura Ral 9005 opaco con retro illuminazione a Led.

*Flush with the wall door MYA swing opening pull right. Panel in CPL laminated white Ash cod. FB01. Tratto handle in Ral 9007 finish without lock hole.  
Skirting flush with the wall STRIP in finish RAL9005 mat, with Led backlighting.*



## CPL

Il CPL è un materiale tecnologico particolarmente resistente alle macchie e all'abrasione. E' diffuso nell'arredamento per la capacità di saper superare la bellezza del legno e trasmettere calore ed emozioni estetiche addirittura superiori al materiale naturale che tende a imitare.

*The CPL is a technologic material resist to the stain and to the abrasion. Is widely used in the furnishing to improve wood beauty and to transmit estetic emotions superior from the natural material that it want imitate.*

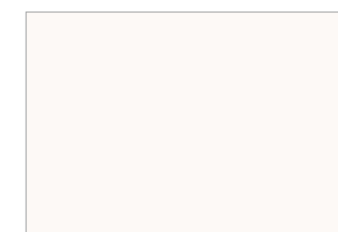

BC 01 Bianco / White

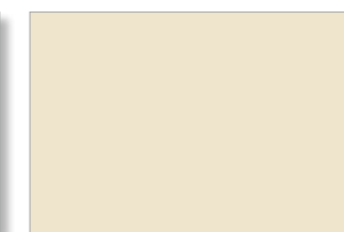

PN 01 Panna / Cream



FB 01 Frassino Bianco / White Ash



PB 01 Palissandro Bianco / Rosewood White



LN 01 Larice Naturale / Natural Larch



NC 02 Noce canaletto / Walnut



PB 02 Palissandro Blu / Rosewood Blue



RS 01 Rovere Sbiancato / White Oak



WG 01 Wengè / Wengé

*Le tinte della presente cartella sono puramente indicative / The colors of this chart are indicative.*



Porte filomuro MYA apertura battente spingere sinistra e tirare destra, in finitura laccata nero Ral 9005 lucido e bianco Ral 9016 lucido e maniglie Tratto in finitura alluminio ox argento. Battiscopa filomuro STRIP in finitura Ral 9005 lucido, con retro illuminazione a Led.

*Flush with the wall swing MYA door opening push left and pull right, in bright black lacquered Ral 9005 and bright white Ral 9016, Tratto handles in aluminum silver. Skirting flush with the wall STRIP in finish RAL9005 bright, with Led backlighting.*



La porta laccata acquista consapevolezza e carattere con piacevoli abbinamenti cromatici in accordo o in totale contrasto con la finitura della parete.  
Le porte MYA sono laccate ancora a mano con vernici a base d'acqua che mantengono nel tempo tonalità e lucentezza. Nulla di paragonabile alle laccature di tipo industriale realizzate con vernici poliuretatiche, più conosciute come finiture a "lucido diretto".

*The lacquered door acquires awareness and character with pleasant color combinations in agreement or in total contrast to the finishing wall.*

*MYA doors are lacquered by hand with water paint that resist in time with tone and brightness. Nothing comparable to the industrial lacquers made with polyurethane varnish, known like finish "direct bright".*



Disponibile in qualsiasi colore Ral  
Available in all Ral colors

## UNA SELEZIONE DI COLORI RAL PIÙ RICHIESTI / A SELECTION OF COLORS RAL POPULAR



*Le tinte della presente cartella sono puramente indicative / The colors of this chart are indicative.*



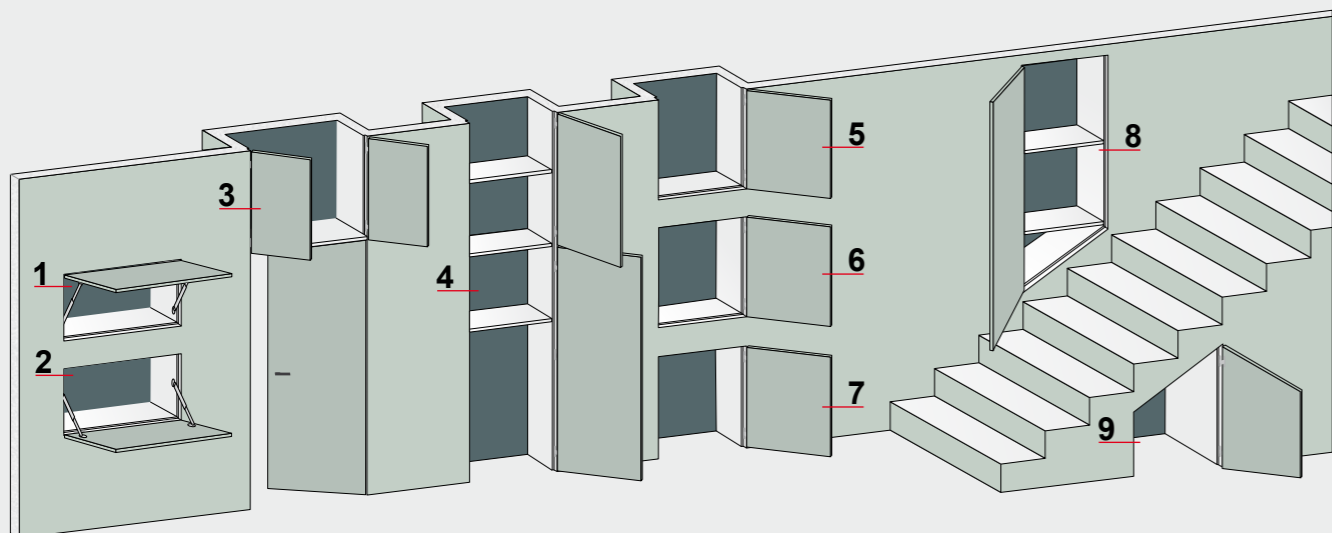

- 1- Chiusura K 100 installazione a ribalta, apertura verso l'alto con braccetti di ritegno / Closing K 100 installation flap, opening up with arms retainer
- 2- Chiusura K 100 installazione a ribalta, apertura verso il basso con braccetti di ritegno / Closing K 100 installation flap, opening down with arms retainer
- 3- Chiusura K 200 con telaio senza traverso superiore, abbinato con porta MYA a spingere / Closing K 200 chassis without upper crosspiece, combined with MYA door to push
- 4- Chiusura K 202 con telaio senza traverso superiore e inferiore / Closing K 202 with the frame without upper and lower crosspiece
- 5- Chiusura K 100 con telaio senza traverso superiore / Closing K 100 with the frame without upper crosspiece
- 6- Chiusura K 100 / Closing K 100
- 7- Chiusura K 100 con telaio senza traverso inferiore / Closing K 100 frame without lower crosspiece
- 8- Chiusura K 100 obliqua lato inferiore / Closing K100 oblique lower side
- 9- Chiusura K 100 obliqua lato superiore con telaio senza traverso inferiore / Closing K100 oblique upper side with the frame without lower crosspiece

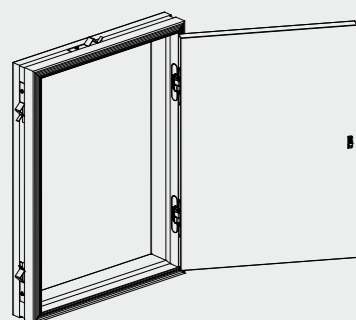

**K 100**  
Chiusura 1 anta  
Closing 1 panel

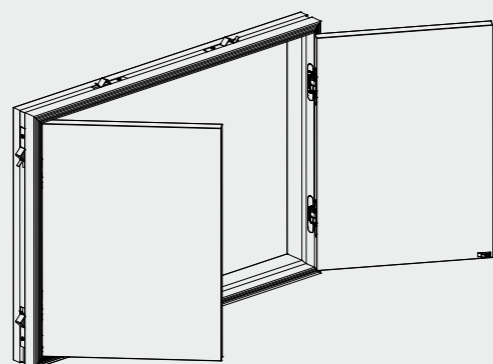

**K 200**  
Chiusura 2 ante affiancate  
Closing 2 panels side by side

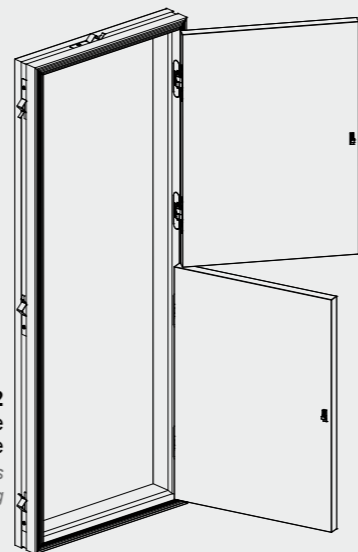

**K 202**  
Chiusura 2 ante sovrapposte  
Closing 2 panels overlapping

## CHIUSURE FILOMURO DI ULTIMA GENERAZIONE, FACILI DA INSTALLARE E CURATE IN OGNI DETTAGLIO

Last generation flush with the wall closure, easy to fix and accurate in every details



Cerniere integrate nell'anta registrabili sui 3 assi con apertura a 180°. Eliminate le inestetiche cerniere a toppa!  
Hinges integrated on the panel registered in 3 axes with 180° opening. Delete the unsightly patch hinges!



Chiusura push-pull di serie, protetta e integrata nel telaio  
Push-push closure of series, protected and integrated on the frame.



Anta a vetro trasparente temprato da 4 mm di serie  
Transparent glass panel 4mm tempered of series.



Anta sp. 30 mm. Robusta e leggera, sovraverniciabile  
Panel sp. 30 mm. Strong and light, over paintable

## DIMENSIONI / DIMENSIONS

	LARGHEZZA / width	ALTEZZA / height
K 100 standard	Et: 38 - 48 - 58 - 68 - 78	da /from 38 a/to 308 di/in 10 in/of 10
K 100 su misura / customized	Et: fino a / until 78	fino a / until 308
K 200 standard	Et: 68 - 88 - 108 - 128 - 148	da /from 38 a/to 308 di/in 10 in/of 10
K 200 su misura / customized	Et: fino a / until 148	fino a / until 308
K 202 standard	Et: 38 - 48 - 58 - 68 - 78	da /from 38 a/to 308 di/in 20 in/of 20
K 202 su misura / customized	Et: fino a / until 78	fino a / until 308

Et = misura d'ordine / order measure

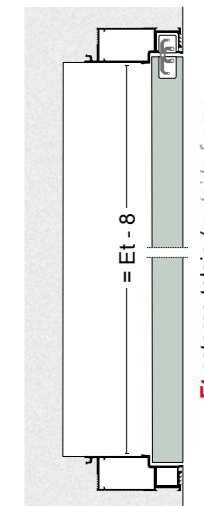
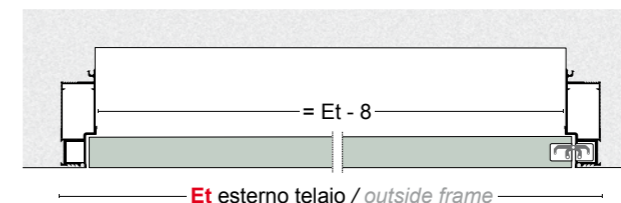

## VERSO DI APERTURA / OPENING DIRECTION

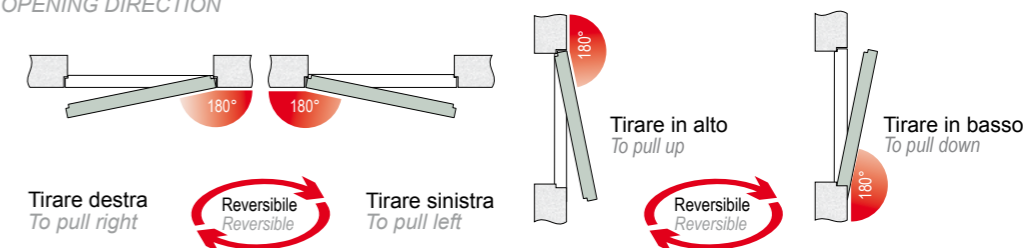

## FORNITURA DI SERIE / SUPPLY OF SERIES

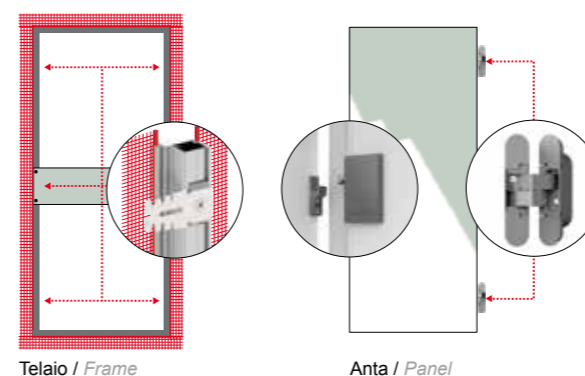

Telaio / Frame

Anta / Panel

Sistema ante e sportelli filomuro per ripostigli apertura battente reversibile, applicabile su pareti in muratura e cartongesso di qualsiasi spessore, disponibile nelle misure standard e su misura. La fornitura comprende: telaio in alluminio estruso da 102 mm in finitura ruvida tipo intonaco sovraverniciabile completo di staffe di fissaggio. Anta tamburata rivestita nelle due facce e nei quattro bordi con carta melaminica sovraverniciabile. Chiusura premi-apri e cerniere registrabili sui 3 assi.

Panel and flush to the wall cage to catchall with swing "reversible" opening, can be applied on brick or plastered walls of any thickness, available in standard measures or customized. The delivery includes: Extruded aluminium frame 102 mm in rough finish completely with fixing brackets, hollowed panel covered in two faces and four edges with paintable melaminic paper. Push-open lock and hidden hinges adjustable on 3 axes.

## PERSONALIZZAZIONI / CUSTOMIZATIONS

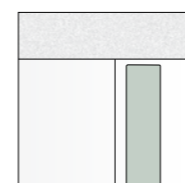

Telaio senza traverso sup.  
Frame without upper

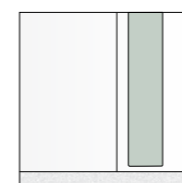

Telaio senza traverso inf.  
Frame without lower

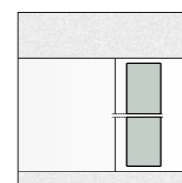

Senza traverso sup. e inf.  
without upper and lower

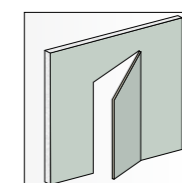

Porta obliqua  
Door oblique



Ante in finitura  
Different finish



Cerniere a colore  
Hinges on color



Chiudiporta a molla  
Spring closer



Chiusura con chiave  
Key lock



Braccetti di ritegno  
Retaining arms



## STRIP

Il battiscopa dal design puro e minimale che delinea l'ambiente senza limitarlo.

The skirting board with pure and minimal design to outline the ambient without limit it.



Battiscopa STRIP con retro illuminazione a Led.  
Skirting board STRIP with LED backlighting.

STRIP è il sistema battiscopa filomuro in alluminio a triplo uso (brevettato), composto dalla base e dal battiscopa. La base ha la funzione di rifinire la parete e supportare il battiscopa, può essere installata indistintamente su pareti in muratura o cartongesso ed è dotata di apposite scanalature di irrigidimento atte ad ospitare le varie giunzioni lineari ed angolari, per un assemblaggio rapido e preciso. Il battiscopa, grazie alla sua particolare sagoma, può essere applicato a chiusura totale della base o lasciando una fuga di 3 mm fra se e l'intonaco. Inoltre, il battiscopa STRIP, può essere retro illuminato con una comune striscia a led per delineare i percorsi. La base è già predisposta per questa applicazione, mentre al battiscopa basta togliere l'aletta di chiusura con una semplice operazione manuale a "strappo" per far passare la luce.

STRIP is the skirting flush with the wall system in aluminium with three use (patented), composed by the base and by the baseboard. The base has the function of to finish the wall support and the skirting board, it can be installed without distinction on the walls or plasterboard and is provided with suitable stiffening grooves adapted to accommodate the various junctions and linear angular, for a fast and precise assembly. The skirting board, thanks to its particular shape, can be applied total closure of the base or a shadow gap of 3 mm between itself and the plaster. In addition, the baseboard STRIP, can be backlit with a common strip led light to outline paths. The base is already prepared for this application, while the skirting board, remove only the flap closure a simple manual operation to "pull" to let the light pass.

Installazione a chiusura totale  
Total closure installation

Installazione con fuga da 3 mm  
3 mm leak installation

Installazione con illuminazione a led  
Led lighting installation

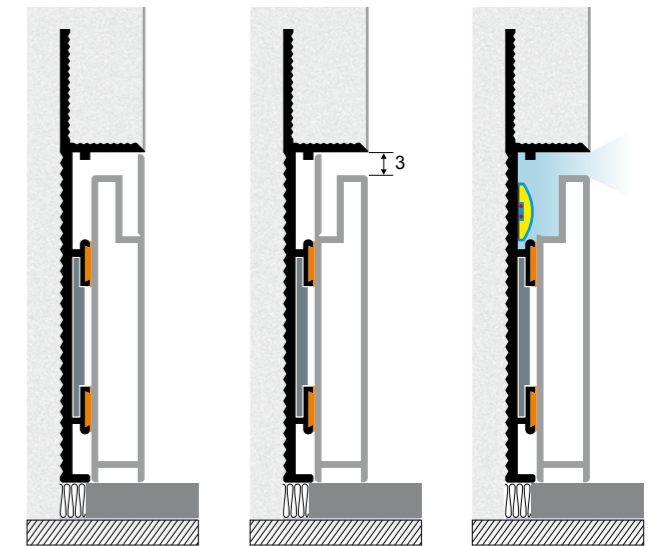

## POSA IN OPERA / INSTALLATION

Nelle pareti in muratura, è consigliabile fissare la base con schiume o adesivi strutturali. Nelle pareti in cartongesso, fissare la base direttamente alla struttura metallica con normali viti. Installare il battiscopa dopo la posa del pavimento e l'imbiancatura delle pareti, tramite il biadesivo in dotazione o con adesivi siliconici commerciali. Il profilo "Base" può anche accogliere battiscopa in legno di tipo commerciale.

In masonry walls, it is advisable to secure the base with foam or structural adhesive. In plasterboard walls, fix the base directly to the metal structure with conventional screws. Install the baseboard after installing the floor and painting of the walls, using the supplied double-sided tape or silicone adhesives business. The profile "Base" can also accommodate wooden skirting commercial.

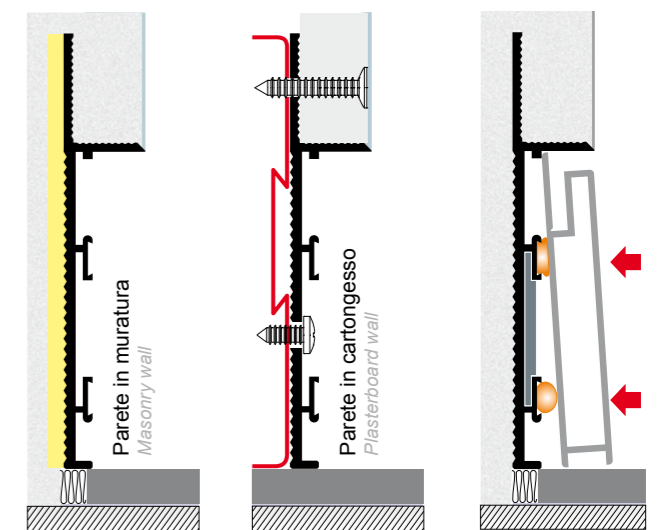

## COMPONENTI / COMPONENTS

### BS 01

Base per battiscopa (barre da 2 mt.)  
Base for skirting (2 mt. bars)

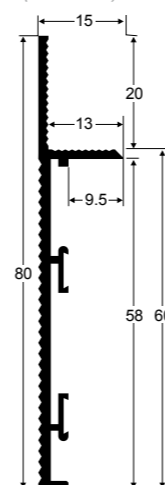

### BS 02

Battiscopa con aletta asportabile per luce a Led. (Barre da 2 mt.)  
Disponibile in tutti i colori Ral.  
Skirting with removable flap for Led light. (2 mt. bars)  
Available in all Ral colors.

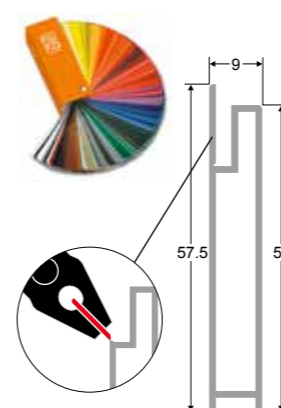

### IBS 100

Telaio incassato per porte con apertura a tirare  
Built-in frame for pull opening doors

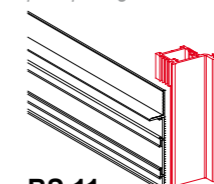

### BS 11

Base raccordata per porte con apertura a spingere  
Base connected for doors with push opening

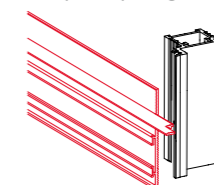

### BS 51

Giunzione flessibile per angoli variabili  
Flexible Junction for variable corners



### BS 53

Coppia tappi terminali  
Terminal pair caps

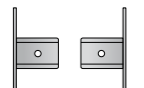

### BS 52

Giunzione fissa 90° per gradini  
Fix junction 90° for steps

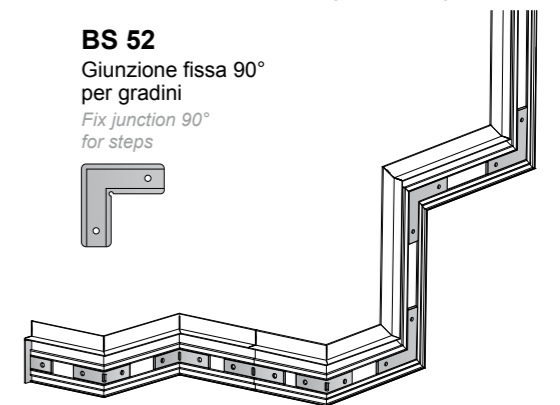
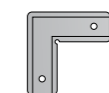



Il cuore delle porte filomuro MYA è rappresentato dall'innovativo e geniale sistema a "tripla azione" che evita l'insorgenza delle antiestetiche screpolature fra telaio e parete, classiche delle porte filomuro di vecchia generazione. Il sistema prevede: 1) un perfetto ancoraggio del telaio alla parete grazie alle robuste staffe in acciaio sagomato di ben 3 mm di spessore. 2) conformazione delle superfici del telaio a "dente di sega" per trattenere in modo irreversibile l'intonaco. 3) rete in fibra di vetro a maglie strette, fissata lungo il bordo del perimetro del telaio, per ingabbiare e fortificare le malte di rifinitura proprio nei punti più sollecitati dai colpi di chiusura dell'anta.

*The Heart of flush with wall doors MYA is represented by new system with triple action that prevents the onset of unsightly cracks between frame and wall, typical of flush with the wall old generation doors.*

*The system provides: 1) Frame good fixed to the wall with robust iron brackets. 2) Frame with walls in "teeth like saw" to keep the wall. 3) glass fiber net fixed to the external boarder of the frame, to close and make robust the wall finish in the topic points.*

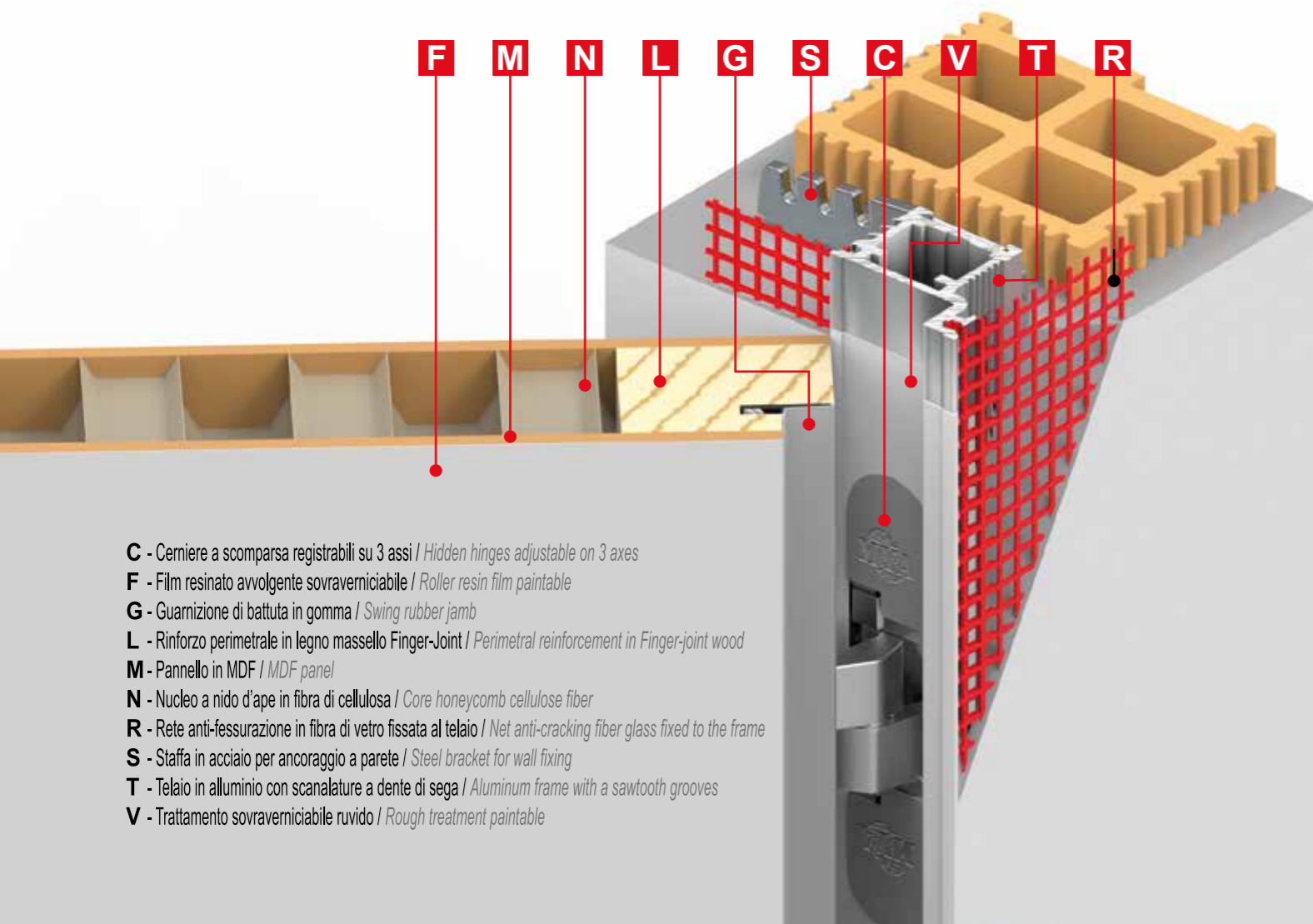

- C - Cerniere a scomparsa registrabili su 3 assi / Hidden hinges adjustable on 3 axes
- F - Film resinato avvolgente sovraverniciabile / Roller resin film paintable
- G - Guarnizione di battuta in gomma / Swing rubber jamb
- L - Rinforzo perimetrale in legno massello Finger-Joint / Perimetral reinforcement in Finger-joint wood
- M - Pannello in MDF / MDF panel
- N - Nucleo a nido d'ape in fibra di cellulosa / Core honeycomb cellulose fiber
- R - Rete anti-fessurazione in fibra di vetro fissata al telaio / Net anti-cracking fiber glass fixed to the frame
- S - Staffa in acciaio per ancoraggio a parete / Steel bracket for wall fixing
- T - Telaio in alluminio con scanalature a dente di sega / Aluminum frame with a sawtooth grooves
- V - Trattamento sovraverniciabile ruvido / Rough treatment paintable

Tutte le parti in alluminio dei prodotti MYA subiscono uno speciale trattamento a base di resine e carbonato di calcio che conferiscono una superficie "ruvida come l'intonaco". Un ulteriore passo in avanti che oltre ad evitare l'intervento con aggrappanti prima dell'applicazione di tinte murali, dona al telaio la stessa superficie ruvida caratteristica delle pareti imbiancate, rendendolo invisibile e perfettamente integrato alla parete.

*All the aluminum parts of the products MYA have a special treatment based on resins and calcium carbonate which give it an area "as rough as the plaster". A further step forward that besides avoiding action with gripping before applying wall colors, gives the frame the same surface characteristic of rough whitewashed walls, making it invisible and perfectly integrated to the wall.*

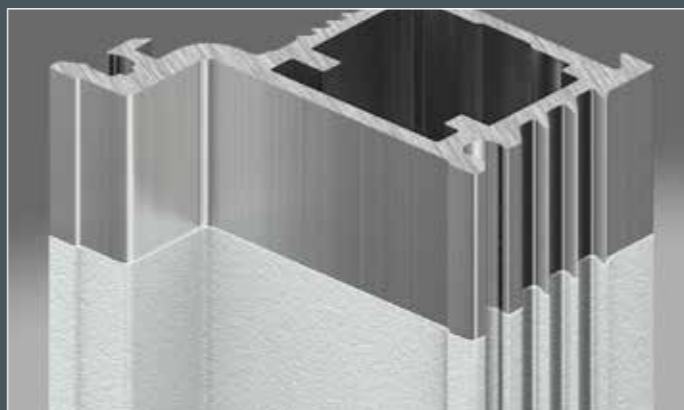

La gamma più completa di telai progettati per essere installati indistintamente su pareti in muratura e cartongesso di qualsiasi spessore, risolvono ogni esigenza tecnica ed estetica, rendono semplice e veloce la posa anche ai meno esperti.

*The most complete range of frames designed to be applied indistinctly on wall or plasterboard of any thickness, solve every technical and aesthetic needs, make easy and quickly the fixage to everyone.*

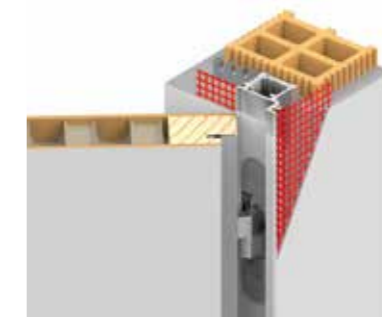

Applicazione su parete in muratura  
*On a brick Wall application*

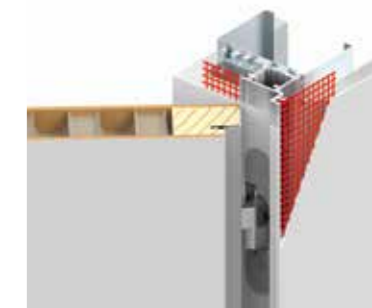

Applicazione su parete in cartongesso  
*On plasterboard application*

## FILOMURO 44

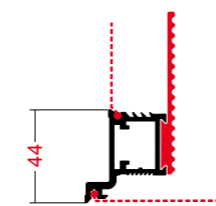

Telaio di serie  
*Standard frame*

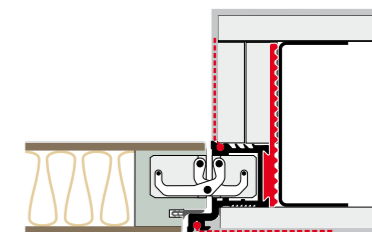
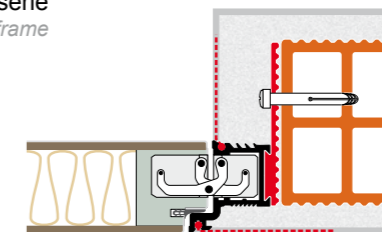

## FILOMURO 102

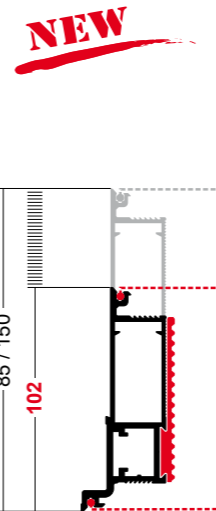

Il nuovo telaio "filomuro 102" per pareti in muratura e cartongesso, è pratico, preciso e semplice da installare. La sua forma avvolgente completa la mazzetta e rifinisce gli spigoli della parete senza ulteriori interventi di ritocco. Realizzabile anche al millimetro da 85 a 150 secondo lo spessore della parete.

*The new frame "filomuro 102" for wall and plasterboard, is pratic, accurate and easy to fix. Its roller form complete the ending part of the wall and finish the plaster corner without other action. Achievable on millimetre from 85 to 150 responding the wall thickness.*

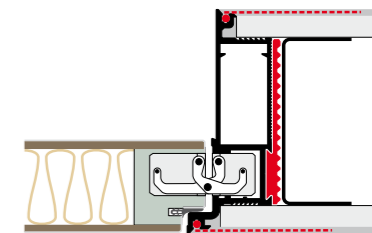
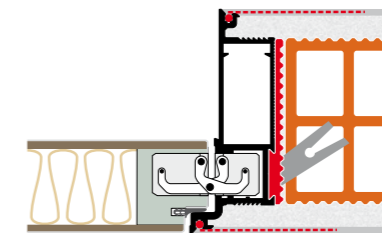
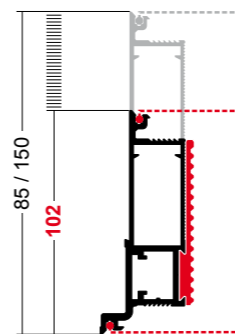

## CENTROMURO 102

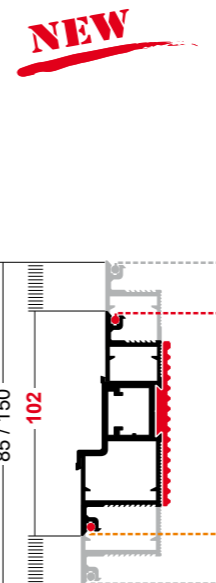

Stessi vantaggi del telaio "filomuro 102" ma con l'anta posizionata al centro della parete, la porta non ha più il dritto e il rovescio ed offre nuove ed esclusive ispirazioni. Finalmente porte scorrevoli e porte battenti possono convivere nello stesso ambiente senza manifestare tutta la loro diversità.

*The same benefits of "filomuro 102" frame but with the panel at the center of the wall, the door haven't the forehand and backhand and offer new and exclusive inspiration. Finally sliding door and swing door can cohabit in the same ambient with the sliding one without show its diversity.*

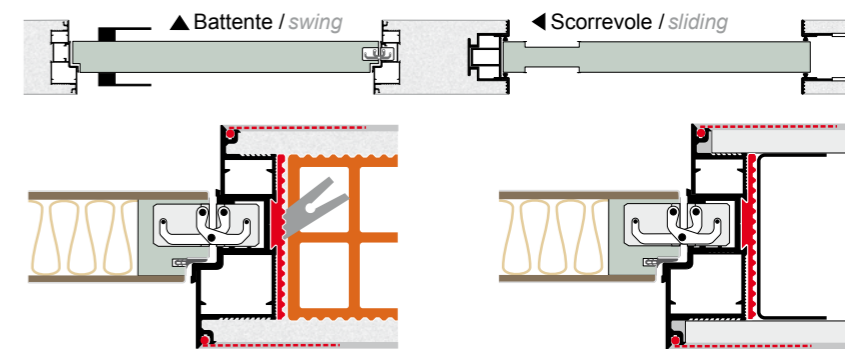



**SERRATURA A CHIUSURA MAGNETICA DI SERIE**  
 Un'idea rivoluzionaria che funziona con una semplice calamita, la chiusura è estremamente fluida e silenziosa, non ha parti sporgenti e la serratura diventa finalmente parte integrante della porta.

**MAGNETIC LOCK OF SERIES**  
 A revolutionary idea to act like a simply magnet, the closure is extremely fluid and silently, without protruding part and the lock became, finally, integrant part of the door.



**Doppia Maniglia Tratto in allum. ox argento**  
 Tratto double aluminum handle oxidized silver

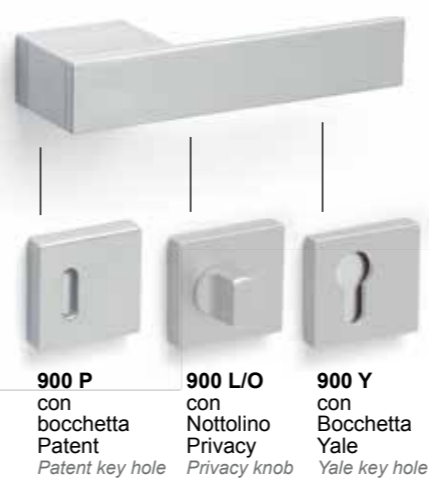

**Doppia Maniglia Tratto in alluminio · colori Ral**  
 Tratto double aluminum handle · color Ral



**Doppia Man. Q-design finitura cromo satinato**  
 Q design double handle satin chrome finish



**Doppia Man. Tratto S incasso in allum. ox argento**  
 Tratto S double aluminium handle flush oxidized silver



**Doppia Man. Tratto S incasso in allum. · colori Ral**  
 Tratto S double aluminum flush handle · color Ral



**Doppia Maniglia Hafele inox satinato**  
 Hafele double handle satin inox finish 940



Maniglie Tratto disponibili in tutta la gamma Ral  
 Tratto handles available in all Ral colors



**SISTEMI DI CHIUSURA A RICHIESTA PER PORTE BATTENTE / CLOSURE SYSTEMS ON REQUEST FOR SWING DOORS**



**SISTEMI DI CHIUSURA A RICHIESTA PER PORTE SCORREVOLI / CLOSURE SYSTEMS ON REQUEST FOR SLIDING DOORS**







Cerniere a scomparsa registrabili sui 3 assi, testate a 200.000 cicli di apertura, dotate di speciali guide in nylon che non richiedono l'uso di lubrificanti. La registrazione è semplice ed intuitiva, basta togliere la cover per accedere ai registri che permettono la regolazione millimetrica dell'anta.

*Hidden hinges adjustable on 3 axes, tested on 200,000 opening cycles, with special nylon road without oil. The registration is intuitive and easy, you have only to open the cover and go to the register to permit the millimetric panel regulation.*



## CORPO CERNIERA E COVER A COLORE / HINGES BODY AND COVER ON COLOR.

In fase di ordine è possibile scegliere la porta con cerniere a colore per un abbinamento raffinato e coordinato con il colore della porta o con le maniglie.

*At the order moment is possible to choose the door with hinges on color to have a refinement combined with the door color or handles color.*

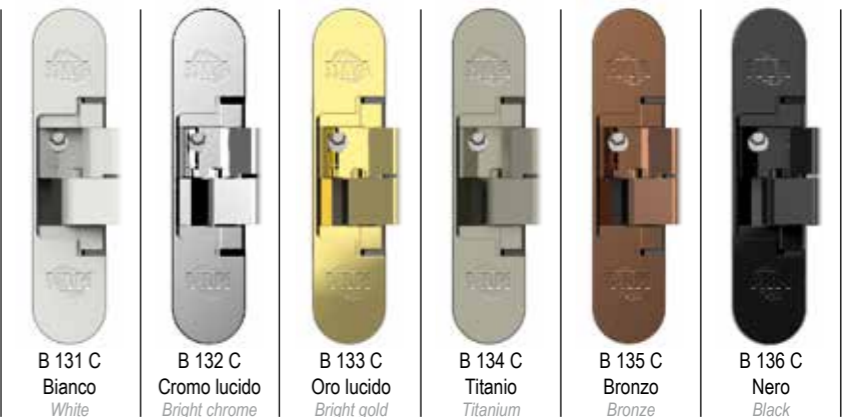

## COVER A COLORE / COVER ON COLOR

Le cover a colore possono sostituire in qualsiasi momento quelle di colore Silver fornite con la cerniera di serie e con il chiudiporta a molla. Una soluzione economica e di immediato effetto.

*The cover can substitute in every moment the Silver one that the hinges have of series, an economic solution with immediate effect.*



## ACCESSORI PER LA CORREZIONE DELLA PLANARITA' DELLE ANTE / ACCESSORIES TO CORRECT THE PANEL FLATNESS

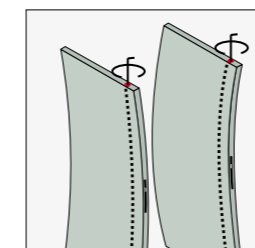

Barra raddrizza ante  
*Bar straighten panels*



Cerniera supplementare  
*Additional Hinge*

Gli accessori per la correzione della planarità dell'anta sono consigliati nei casi in cui i due lati della porta devono essere trattati con finiture o spessori di vernice diversi fra loro, oppure quando la porta si trova in ambienti con elevato tasso di umidità o nelle vicinanze di fonti di calore naturali o artificiali. Le porte con altezza superiore a 245 cm hanno questi accessori già di serie.

*The accessories to correct the panel flatness are recommended when the two door side can be treated with different thickness of finish or paint, or when the door will be in humid ambient or near heat sources. The door with height more than 245 cm has it of series.*

## ACCESSORI PER L'AUMENTO DEL POTERE FONOISOLANTE / ACCESSORIES FOR THE INCREASE OF THE SOUND INSULATION

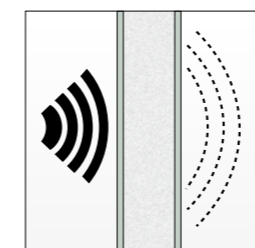

Anta "Silent"  
*"Silent" panel*

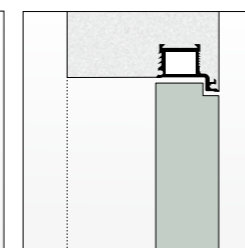

Telaio con battuta superiore  
*Frame with upper swing*



Barra mobile antirumore  
*Mobile noise barrier*

Le porte Mya possono essere equipaggiate con ante speciali e corredate di accessori che offrono un'ottima tenuta, anche a pavimento, per ottenere un considerevole aumento del loro potere fonoisolante. Una soluzione semplice ed economica per agire in libertà in casa senza creare o ricevere disturbo. (solo per porte battente)

*Mya doors can be equipped with special doors and accessories that offer excellent hold, even in the floor, to achieve a considerable increase in their sound insulation. A simple and inexpensive solution to act freely in the house without causing or receiving interference. (only for doors swing)*



*è un marchio / is a trademark*



*Solutions for your home*

**ROYAL PAT** S.r.l. Unip.  
Via Campiglione, 20 - 63900 FERMO  
Tel. 0734 628303 - Fax 0734 628201  
[www.royalpat.it](http://www.royalpat.it) - [Info@royalpat.it](mailto:Info@royalpat.it)