

COMUNELLO

LIFE MADE EASY

COMUNELLO 
GATE DIVISION

COMUNELLO 
FRAME DIVISION

COMUNELLO 
FRAME AUTOMATION



CATALISTINO **2018**
PRICE LIST

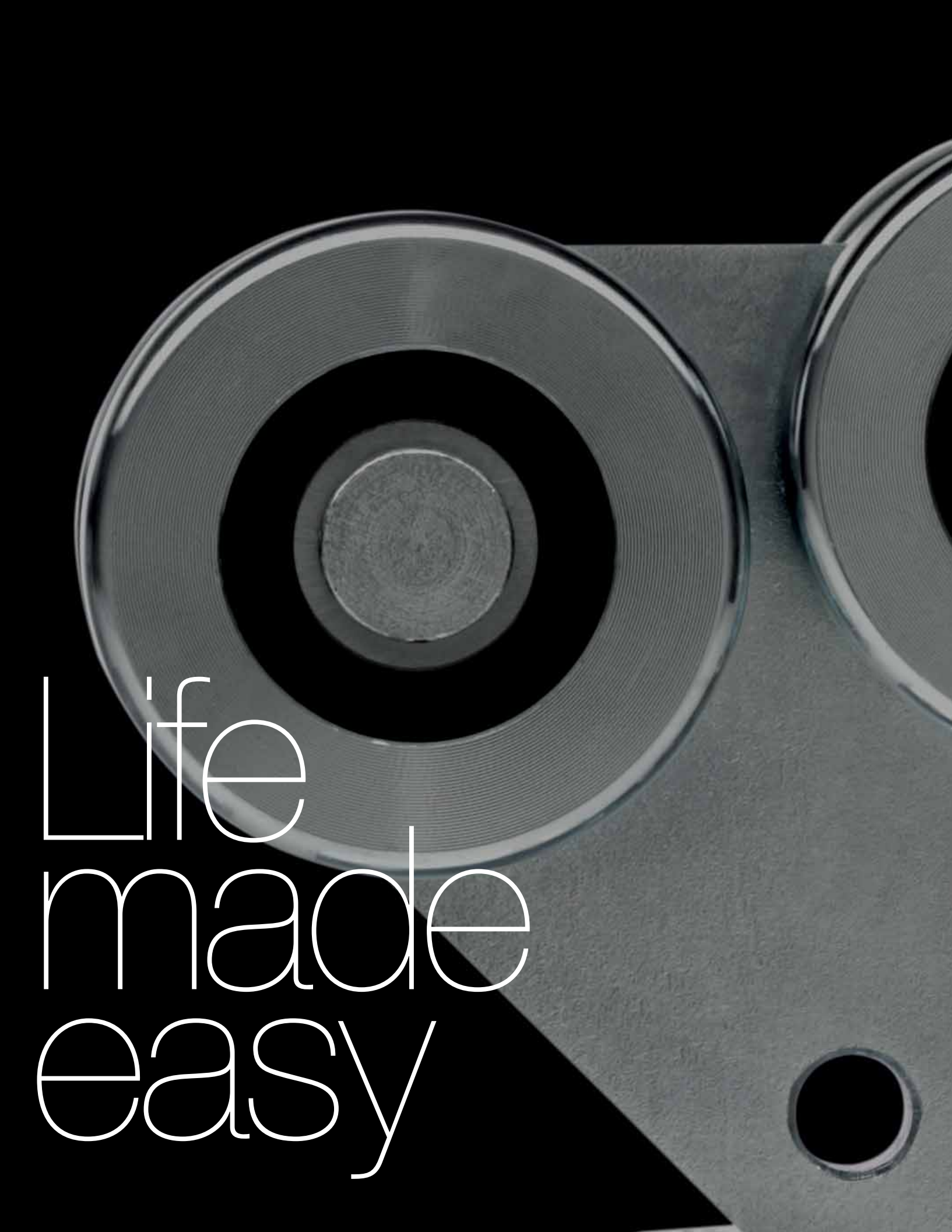

Life
made
easy

 **COMUNELLO**



Life
made
easy

COMUNELLO
GATE DIVISION

COMUNELLO
FRAME DIVISION

COMUNELLO
FRAME AUTOMATION

www.comunello.com



CATALISTINO INDEX

COMPONENTI PER CANCELLI 18

SQUADRETTE 157
MANIGLIONI 195

AUTOMAZIONE PER FINESTRE 225



Attingendo alle migliori virtù e risorse della terra dove sorge sin dalla sua fondazione nel 1965, l'azienda Fratelli Comunello, storicamente conosciuta per essere leader nel settore dei componenti per cancelli, ha di fatto sviluppato un prodotto che è da sempre alla base della sua mission: la qualità assoluta. Concetto che nel tempo si è esteso ed evoluto declinandosi in tre divisioni altamente specializzate e cioè FRAME, GATE ed AUTOMATION quest'ultima a sua volta suddivisa in Mowin, che fornisce attuatori per finestre, cupole, lucernai e tende, e in Gate Automation che offre al mercato una gamma sempre innovativa di motori per l'automazione dei cancelli progettati e realizzati secondo i più alti standard sia per prestazioni che per estetica.

Drawn from the best resources of the area where the company was founded in 1965, Fratelli Comunello, a leading international name in the manufacture of gate components, has developed one product that has become the cornerstone of its Mission: Quality. Over time this guiding principle has evolved and today forms the foundation of our three highly specialised divisions: FRAME, GATE and AUTOMATION. The AUTOMATION Division is split into two parts, Mowin which supplies actuators for windows, domes, skylights and curtains, and Gate Automation which supplies an innovative range of motors for gate automation designed and manufactured to the highest standards of performance and style.

La divisione fa la forza

COMUNELLO
GATE DIVISION

COMUNELLO
FRAME DIVISION

COMUNELLO
FRAME AUTOMATION

COMUNELLO
AUTOMATION

Quattro divisioni che esprimono quelli che sono i valori di Comunello: qualità assoluta, alta precisione, ricerca ed innovazione. Ogni progetto è apertura verso il futuro e riferimento sicuro per i settori specifici di ciascuna divisione.



Il senso di un gruppo sta in una forza che è somma di tutte le singole forze e compendio delle migliori attitudini. L'aspetto più evidente di questa sinergia sono i valori condivisi che si esprimono in tutto ed in ogni parte del tutto. Qualità nei materiali, nella ricerca e progettazione, negli investimenti e nella lavorazione. Qualità nel servizio e nei comportamenti. Dall'elemento al movimento, aziende e divisioni, unite da un unico spirito, raccolgono con grande positività ogni sfida del futuro.

A Group is the sum of the forces of all of its parts, the essence of the best it has to offer. At Comunello the clearest evidence of this united approach is in our shared values which cover everything and every part of everything. Quality in materials, research, design, in the investments and in the manufacturing processes. Quality in the service and in our behaviour. From the component to the movement, the company and its divisions are all united by a single spirit and inspired by every new challenge the future holds.

L'azienda è attenta al rispetto dell'ambiente e a tutte le tematiche inerenti la sicurezza sul lavoro e la tutela della salute di tutti i suoi lavoratori. Inoltre, per una maggiore garanzia e controllo della qualità del prodotto, l'Azienda gestisce un sistema di gestione conforme alle norme UNI EN ISO 9001:2008 certificato dal TÜV SÜD / *The Company takes its environmental responsibilities seriously and is committed to respecting Health and Safety laws so as to provide a safe working environment for its employees. Furthermore, in order to provide a further guarantee and greater control over the quality of the products, the Company uses a management system in line with UNI EN ISO 9001:2008 standards as certified by TÜV SÜD.*





Il moto perpetuo

I componenti per la movimentazione dei cancelli *Components for gate movement*

La divisione GATE progetta e realizza componenti per la movimentazione di cancelli e portoni industriali e cioè la produzione storica dell'azienda che ne ha fatto da anni leader nel settore. Dal 1965 infatti, l'azienda ha sviluppato un concetto di qualità assoluta ed è in grado di fornire la gamma più completa ed affidabile di accessori per questo tipo di funzione e di offrire garanzie in merito a qualità del prodotto e del servizio cui i partner fanno da sempre riferimento. Il cliente può contare su un'assistenza tecnica professionale qualificata e su consegne puntuali e sulla base delle sue specifiche esigenze.

The GATE Division is responsible for the design and manufacture of gate and industrial door components. This is the company's original field and where we have been an industry leader for many years. Since 1965 the company has developed a concept for absolute quality and provides the widest and most reliable selection of accessories for gate movements as well as iron-clad guarantees for both the quality of the product and the quality of the service we offer to our partners. Clients can rely on qualified, professional technical support and on-time deliveries based on their specific needs.

Application



La precisione diventa sistema

Le squadrette per serramenti e i maniglioni *Corner joints and handles*

Una visione razionale d'insieme caratterizza una proposta che non si limita ad una serie di elementi singoli ma presenta una gamma di sistemi di squadrette estremamente completa. Tutti i prodotti sono made in Italy. Massima facilità di utilizzo, montaggio e regolazione; operazioni corredate in ogni caso da materiale stampato di supporto. I valori del gruppo si esprimono anche nell'importante segmento della produzione dei maniglioni. Ricerca, qualità dei materiali, che sono acciaio inox, alluminio e nylon, e controllo. Design curatissimo ed italiano, forme intelligenti ed ergonomiche.

Our truly visionary concept for the development of the product range means that more than a series of single elements we offer a complete range of corner joint systems. All of our products are 100% made in Italy. They are extremely easy to use, install and adjust and come with high-quality purpose-made moulded supports. The values of the Comunello Group are also visible in our range of handles where research, materials and quality are, as always, fundamental. Made from a choice of stainless steel, aluminium or nylon they provide the highest levels of control. Their Italian design ensures they are stylish and attractive with intelligent, ergonomic shapes.

Application



COMUNELLO
FRAME DIVISION



L'automazione resa facile

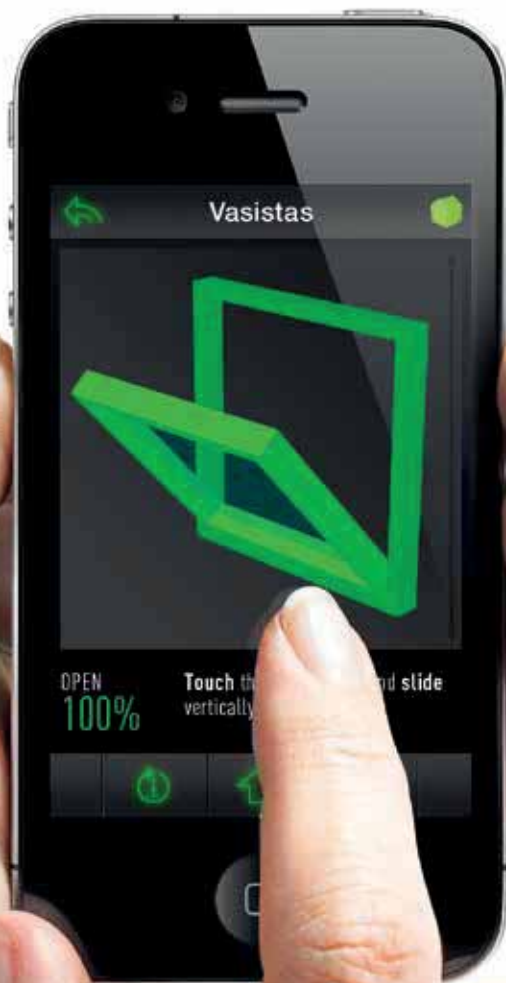

La gestione automatizzata da remoto di abitazioni, industrie, posti pubblici, grandi opere ed infrastrutture sempre più entra nel computo progettuale come elemento ormai associato.

Mowin Open App è una web application basata su interfaccia web; sfrutta quindi la flessibilità e l'ubiquità della "nuvola digitale" (cloud) ed è di conseguenza compatibile con tutte le piattaforme digitali, dal computer al tablet allo smartphone, e con tutti i sistemi operativi. Ma soprattutto, oltre a poter gestire le funzioni di Mowin da qualunque punto dell'abitazione o dello stabile, potete farlo anche da qualunque parte del mondo voi vi troviate.

*The remote management of homes, business premises, public spaces and infrastructure has become an increasingly fundamental part of architectural and urban design projects. The **Mowin Open App** is a web application which exploits the flexibility and global reach of the Cloud to be compatible with all digital platforms from computers to tablets to smartphones as well as with any OS. But more than this, these systems can be managed as effectively from any part of the world as they can from any part of the house or business premises.*





Gli attuatori elettromeccanici *The Electromagnetic actuators*

Il progetto Frame Automation nasce dalla lunga esperienza maturata da Comunello nella movimentazione meccanica di serramenti e cancelli. Quanto mai reali ed effettive restano le garanzie di qualità e durabilità, irrinunciabili quindi anche nei nuovissimi attuatori elettromeccanici. Stabili, altamente flessibili, esteticamente accattivanti per il design moderno e raffinato, le serie Frame Automation sono adatte a diverse applicazioni: finestre, cupolini, lucernai, pale frangisole, tende, tapparelle. Perfettamente a loro agio in ambienti residenziali.

The Frame Automation project is based on the Company's long experience with mechanical movement systems for windows and gates. With this brand new line of electromechanical actuators we remain committed to guaranteeing our renowned levels of quality and durability to our customers. The Frame Automation series is stable, highly flexible and attractive with modern, refined designs. The units are suitable for a range of applications including windows, domes, skylights, brise soleil blades, curtains and shutters. They are perfectly at home in residential settings.

Application



Eccellenza meccanica Semplicità elettronica





Automazioni per ingressi automatici *Automation for automated openings*

Un'evoluzione spontanea ci ha portati nel tempo a ricercare e sviluppare questo progetto ambizioso ed estremamente importante per il Gruppo che oggi è in grado di garantire ogni fase delle operazioni di apertura attraverso una gamma completa di motori ai massimi livelli di sicurezza, funzionalità e praticità. Accanto alla qualità garantita dall'etica produttiva Komunello, la nuova linea di motori si pone nettamente all'avanguardia in fatto di innovazione tecnologica e di design, che si presenta fluido, elegante ed originale. La volontà di offrire al settore risposte puntuali ed esaurienti ha comportato la progettazione di specifici attuatori elettromeccanici divisi per le diverse tipologie di apertura in base a funzioni e dimensioni dei cancelli che devono andare a muovere.

This ambitious project is based on our commitment to providing complete solutions. Today we supply motors for all kinds of openings with an extensive range designed to provide the highest levels of security, performance and practicality. Alongside the guarantee of quality that comes from Komunello's renowned manufacturing ethics, this new line of motors is leading the industry with its technological innovation and stylish, original designs. The desire to provide rapid, complete solutions to sector needs has led to the design of specific electromechanical actuators for the various types of openings based on the function and size of the gates they need to move.

Application



Life
made
easy

COMUNELLO
GATE DIVISION





Gate Components



LEGENDA

	Articolo / Article		Pezzi per confezione / Pieces per pack
	Misura specifica / Measure		Peso confezione / Weight of pack
	Finitura / Finishing		Prezzo / Price
	Regolazione / Regulation		Su richiesta / On request
	Portata / Capacity		Lubrificazione / Greasing
	Portata singolo carrello / Capacity of single carriage		Cuscinetti / Bearings
	Abbinamento monorotaia / Related monorail		Accessori in acciaio inox / S-Steel accessories
	Abbinamento tiranti / Related tie roads		



CANCELLO SCORREVOLE / SLIDING GATE

Gli accessori meccanici sono di fondamentale importanza per rendere sicuro il cancello durante la sua movimentazione. La normativa Europea UNI EN 13241-1 obbliga tutti i costruttori ad adempiere ad una serie di modalità costruttive.

Mechanical accessories are extremely important to make the gate safe during its movements. European Directives UNI EN 13241-1 forces in fact all the constructors to fulfill a series of construction obligations.

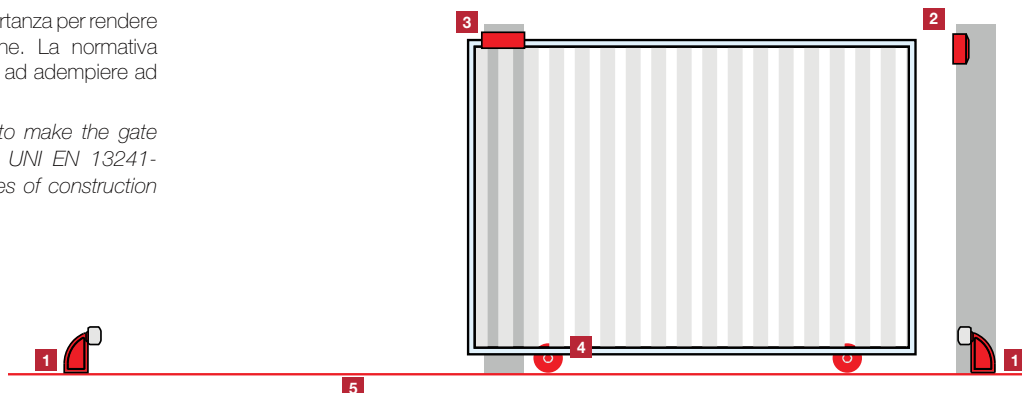

1 ARRESTI DI FINE CORSA / GATE STOPS

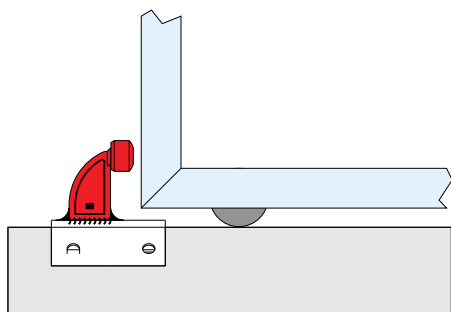

Gli arresti di fine corsa Comunello sono sottoposti a severi test d'urto che ne garantiscono la robustezza anche con impatti violenti.

Comunello gate stops undergo strict force tests, conducted using qualified testing devices.



200P
200G
200i G

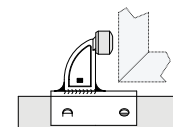

202



202A

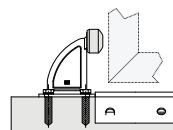

202 F/A

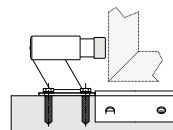

202 F/C

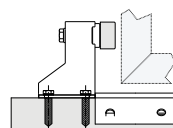

2 ARRESTI DI FINE CORSA / GATE STOPS

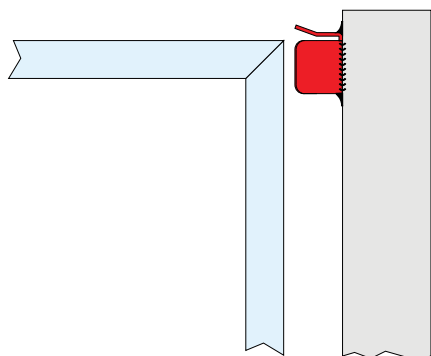

Nella posizione di chiusura l'arresto di fine corsa è un accessorio di fondamentale importanza, serve a rendere sicuro il cancello evitando anche la caduta in caso di urti accidentali.

It is fundamentally important to place strikes in the closing position: they make the gate safe avoiding its fall in case of accidental impact.



199

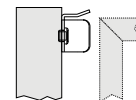

203

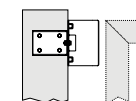

204

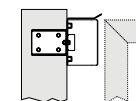

CG-30

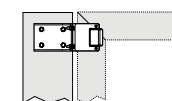

3 PIASTRA GUIDA SUPERIORE PER COLONNA SINGOLA / GUIDING PLATES FOR SINGLE POST

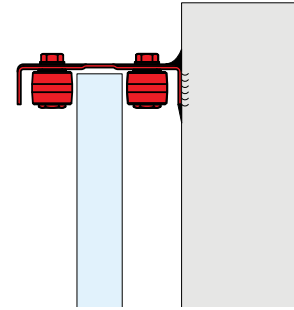
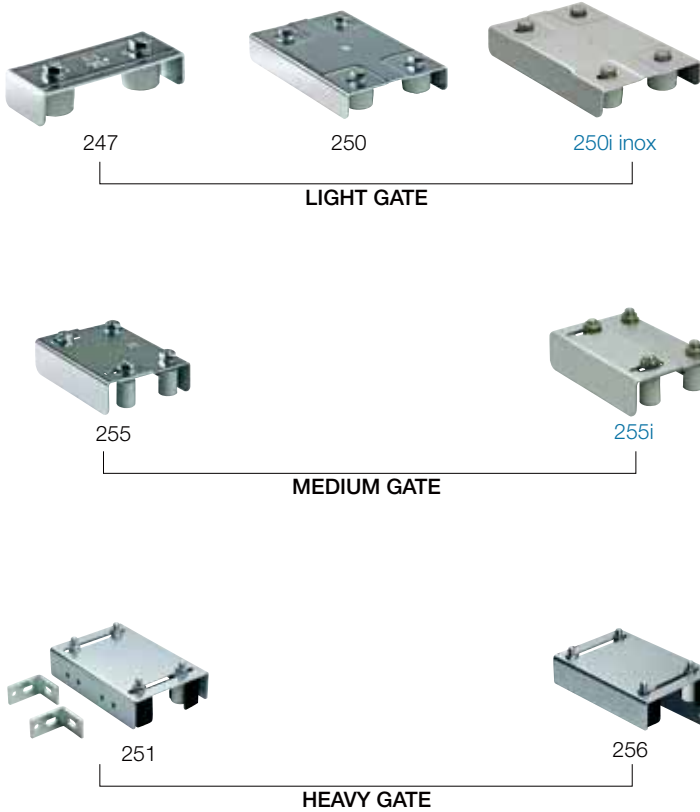

Le piastre guida cancello sono sviluppate per diverse tipologie e modalità di applicazione a seconda delle specifiche esigenze. Da quelle di tipo leggero a quelle regolabili, per cancelli di media e pesante struttura.

Comunello guiding plates have been developed for many different applications: we offer both "light" guiding plates and adjustable ones, the latter best suited for medium and heavy structures.

3 PIASTRA GUIDA SUPERIORE PER COLONNA DOPPIA / GUIDING PLATES FOR DOUBLE POST

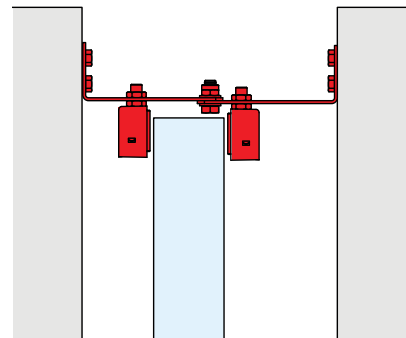
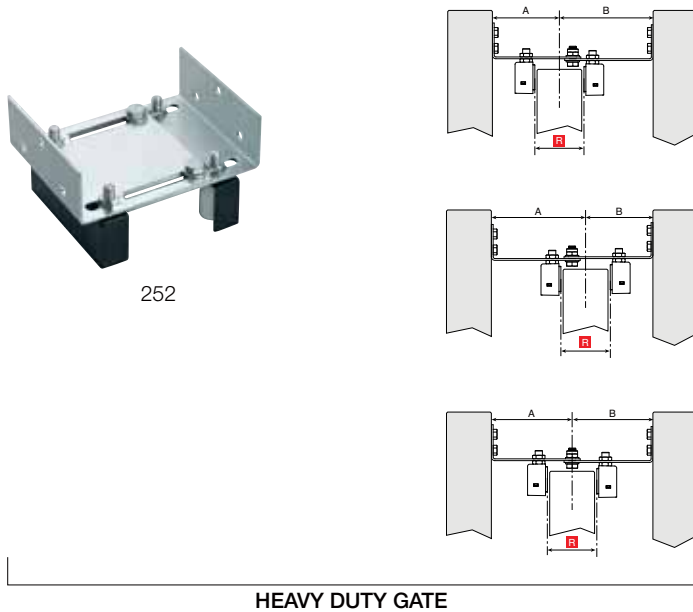

Per cancelli di grandi dimensioni l'adozione del doppio pilastro è una sicurezza maggiore e necessaria. La piastra 252 è la soluzione ideale per le regolazioni multiple da svolgere dopo aver installato il cancello.

Double post is the safest solution to be adopted for gates of big dimensions. The 252 guiding plate is perfect when multiple adjustments need to be made after the gate installation.

RUOTE / WHEELS

Le ruote Comunello sono tutte certificate con prove di laboratorio in cui viene garantita la durata di oltre **2.000.000 cicli**.

Comunello wheels are all certified by laboratory tests that guarantee durability for more than 200.000 cycles. **2.000.000 cycles**.



La vasta gamma di ruote Comunello sono tutte rigorosamente in acciaio C40 e protette da zincatura elettrolitica. Vengono prodotte con tecnologie di altissima precisione e con standard meccanici di elevata qualità.

Le versioni delle ruote in **acciaio inox** garantiscono una maggiore garanzia di durata e funzionalità su zone climatiche particolarmente umide o con percentuali saline elevate. I cuscinetti sono tutti di nuova generazione, sviluppati su richieste tecniche e specifiche Comunello perfettamente schermati.

The wide range of Comunello wheels are rigorously made of steel C40 and protected by electrolytic galvanizing. Moreover, the wheels are manufactured using high precision technology and superior quality standards.

The **stainless steel** wheel version with stainless steel bearing guarantees longer duration and better functionality under conditions of humid climate or high saline concentration. All bearings are all new and developed under precise technical requirements and specifications and are all perfectly shielded.



Ø ruota
Ø wheel

SCEGLI LA RUOTA IN BASE ALLA PORTATA / VIEW THE LOAD CAPACITIES OF COMUNELLO WHEELS

(Es: per un cancello con peso della struttura P=600kg si devono scegliere 2 ruote con una portata minima di 300 Kg cad.)

(Ex: If the gate's weight is P=600Kg you have to choose 2 wheels with a minimum load capacity of 300 Kg each)

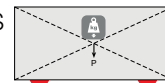

Ø 250												1500 Kg	800 Kg	1500 Kg
Ø 200	330 Kg	400 Kg	625 Kg	800 Kg	330 Kg	600 Kg	330 Kg	400 Kg	625 Kg	800 Kg	800 Kg	1000 Kg	750 Kg	1000 Kg
Ø 160	290 Kg	370 Kg	575 Kg	770 Kg	290 Kg	560 Kg	290 Kg	370 Kg	575 Kg	770 Kg	750 Kg	960 Kg	710 Kg	960 Kg
Ø 140	270 Kg	270 Kg	550 Kg	540 Kg	270 Kg	540 Kg	270 Kg	270 Kg	550 Kg	540 Kg	710 Kg			
Ø 120	240 Kg	240 Kg	450 Kg	420 Kg	240 Kg	420 Kg	240 Kg	240 Kg	450 Kg	420 Kg	400 Kg	600 Kg	400 Kg	600 Kg
Ø 100	220 Kg	220 Kg	425 Kg	400 Kg	220 Kg	400 Kg	220 Kg	220 Kg	425 Kg	400 Kg	380 Kg	580 Kg	380 Kg	580 Kg
Ø 90	210 Kg	210 Kg			210 Kg		210 Kg	210 Kg						
Ø 80	200 Kg	200 Kg			200 Kg		200 Kg	200 Kg						
Ø 70	190 Kg						190 Kg							
Ø 60	100 Kg	100 Kg			100 Kg		100 Kg	100 Kg						
Ø 50	70 Kg						70 Kg							
Ø 40	50 Kg						50 Kg							
	300V-U	300V i	305V-U	305V i	306Y	307Y	310ST	310ST i	315ST	315ST i	320V-U-Y	322 V-U-Y	323 ST	324 ST
		INOX ST. STEEL		INOX ST. STEEL				INOX ST. STEEL		INOX ST. STEEL		ingrassatore grease	ingrassatore grease	ingrassatore grease





CANCELLO AUTOPORTANTE / CANTILEVER GATE SYSTEM

La gamma di carrelli autoportanti CGS-350 e CGS-250 è la migliore soluzione per tutti i sistemi di cancelli autoportanti. A seconda delle esigenze del mercato sono disponibili le serie a 5 e 8 ruote nelle misure mini, piccole e grandi. La serie mini è la migliore soluzione per cancelli piccoli assicurando alte prestazioni in termini di capacità e durabilità.

The product series CGS-350 and CGS-250 are the best solution for any cantilever system. According to each market requirement we provide 5- and 8-wheel carriages in the three versions Mini, Small and Large. The series Mini is the best solution for small gates, assuring high performances in terms of loading capacity and durability.

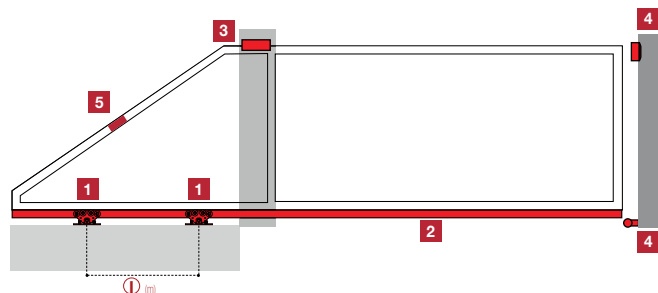

5 RUOTE / WHEELS

1	BEST PERFORMANCE	2	HYBRID	2
 STEEL	 CGS 350.5 M CGA 350.5 M	 CGS 345 M CGA 345 M	 CGS 250.5 M	 CGS 245 M
 iNOX / ST. STEEL ALUMINIUM	 CGS 350.5 P CGi 350.5 P CGA 350.5 P	 CGS 345 P CGi 345 P CGA 345 P	 CGS 250.5 P	 CGS 245 P
 STEEL	 CGS 350.5 G CGS 350.5 XL	 CGS 345 G CGS 345 XL	 CGS 250.5 G	 CGS 245 G

8 RUOTE / WHEELS

1	BEST PERFORMANCE	2	HYBRID	2
 STEEL	 CGS 350.8 G	 CGS 345 G	 CGS 250.8 G	 CGS 245 G
 STEEL	 CGS 350.8 P	 CGS 345 P	 CGS 250.8 P	 CGS 245 P
 STEEL	 CGS 350.8 M	 CGS 345 M	 CGS 250.8 M	 CGS 245 M

3 PIASTRE GUIDA / GUIDING PLATES

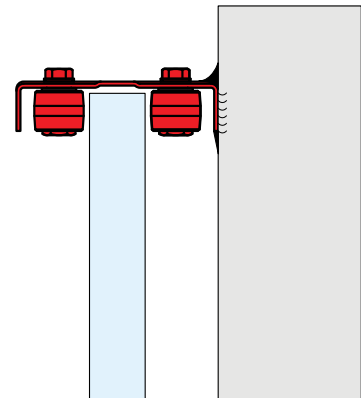
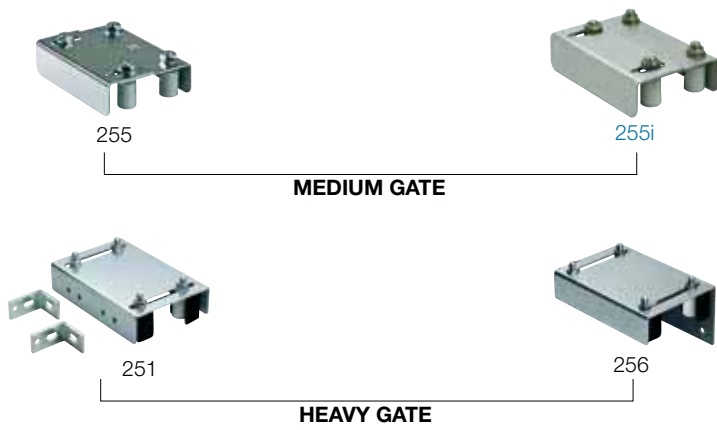

4 ACCESSORI DI BASE / BASIC ACCESSORIES



CGS-346

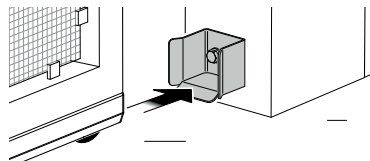

CG-30

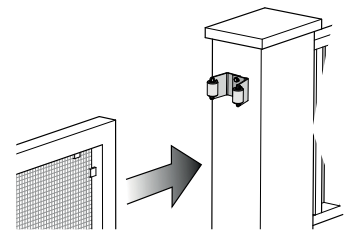

CGS-347

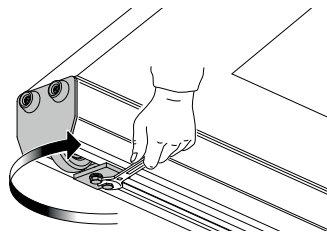

CG-20

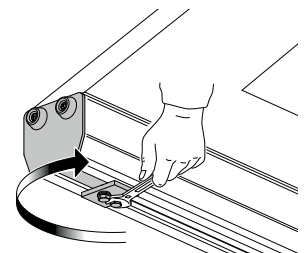

5 ACCESSORI DI REGOLAZIONE / ADJUSTMENT ACCESSORIES



CG-40

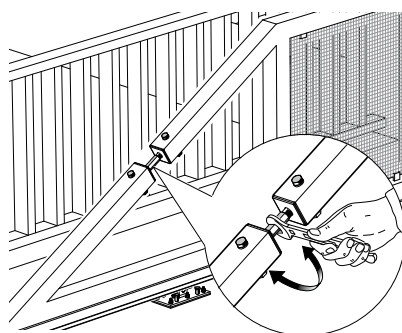

CG-15

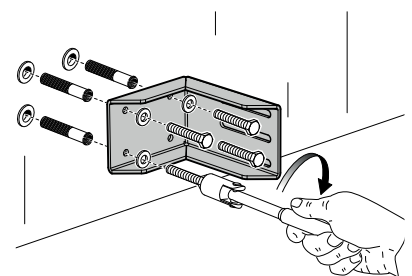



CANCELLO AD ANTA BATTENTE / SWING GATE SYSTEM

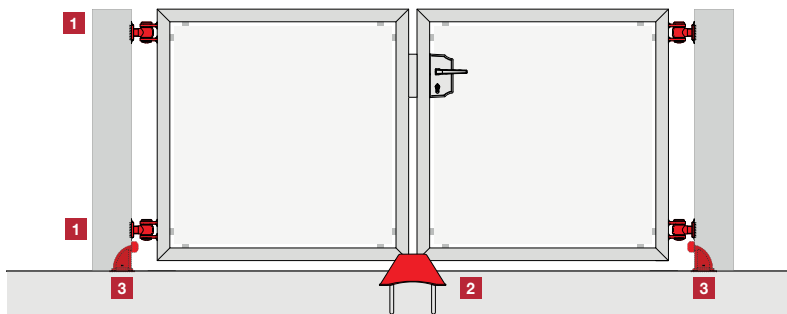

Comunello offre la gamma più vasta di cardini presente sul mercato per tutte le tipologie di aperture ad anta. Dalle soluzioni di tipo residenziale leggero a quelle di tipo industriale pesante, con più di 5 combinazioni di fissaggio e possibilità di regolazione post installazione. Grazie allo sviluppo di tecnologie brevettate e con una scelta oculata di materiali e lavorazioni l'azienda è in grado di offrire soluzioni all'avanguardia.

Comunello is able to offer the widest range of hinges you can find on the market for all types of swing openings: both light residential and heavy industrial solutions, more than 5 fixing combinations and high post-installation adjustability. Thanks to the development of patented technologies and to the careful selection of materials and procedures, the company is able to offer the most innovative solutions.

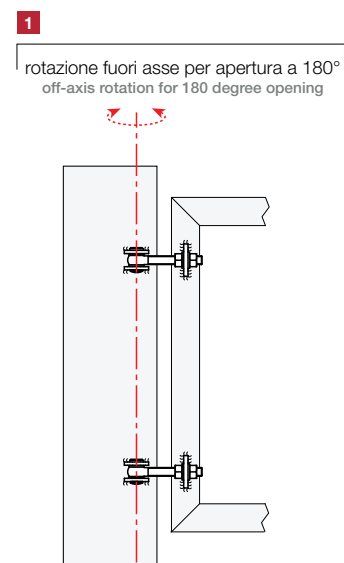
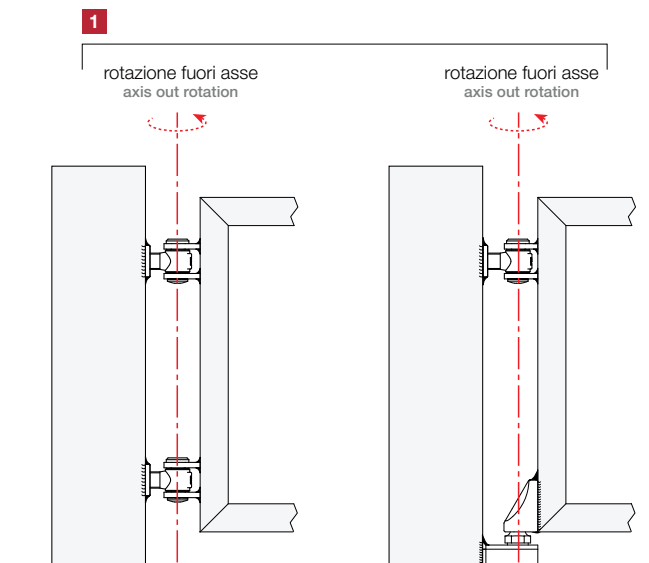
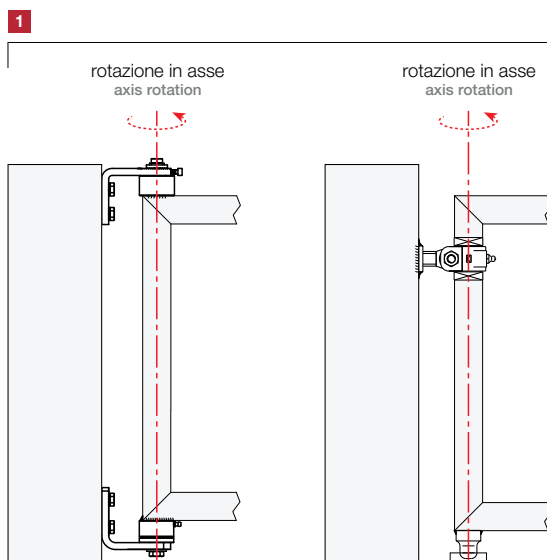

Hs700
COVER SYSTEM

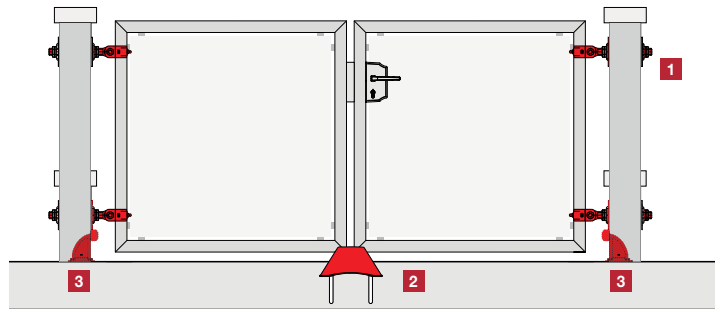

2 BATTENTI / END STOPS



166



169



170



171

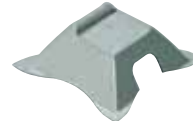

167

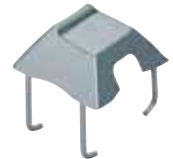

168

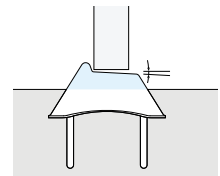
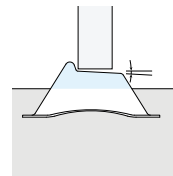
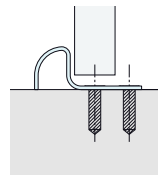
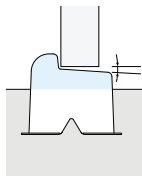
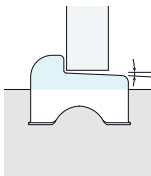
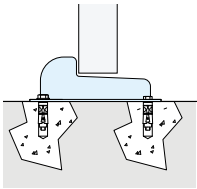

3 ARRESTI DI FINE CORSA / RUNAWAY STOPS

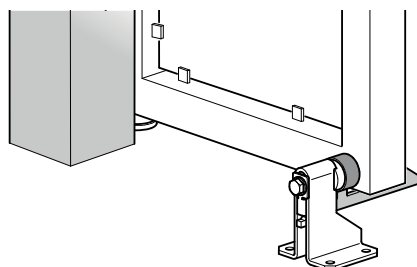
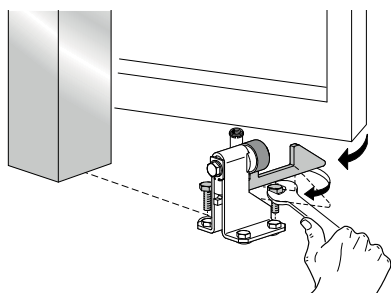
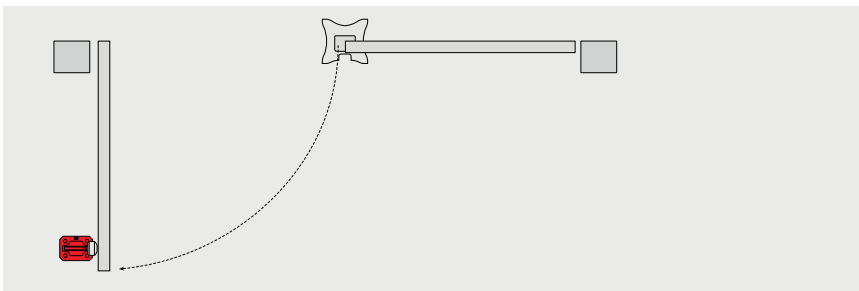

202 F-B



CANCELLO PEDONALE / PEDESTRIAN GATE

Comlock è la serratura brevettata Comunello adatta ai cancelli pedonali. Estremamente flessibile e semplice da installare. Un'incontro in alluminio e gli adattatori in nylon permettono la migliore regolazione su tutti i tipi di profili. La dima di foratura, per profili da 10 a 60 mm semplifica infine la preparazione e l'installazione rendendo il sistema Com-lock adattabile e semplice in tutte le sue parti.

ComLock is the Comunello patented lock especially designed for pedestrian gates. ComLock is extremely flexible and easy to be installed. The end cup and the nylon adapters allow better adjustment on all profile types. The drilling fixture for profiles from 10 to 60 mm simplifies its preparation and installation, making this system easily adaptable and simple.

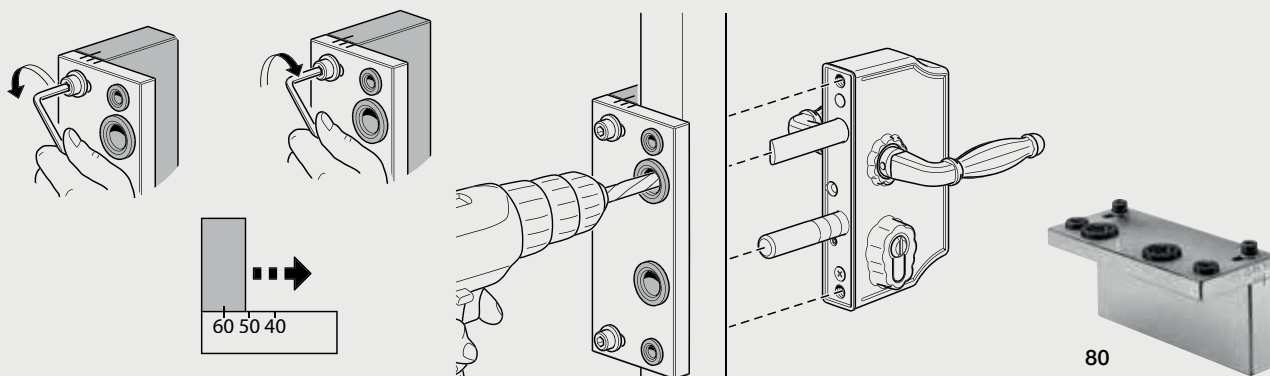
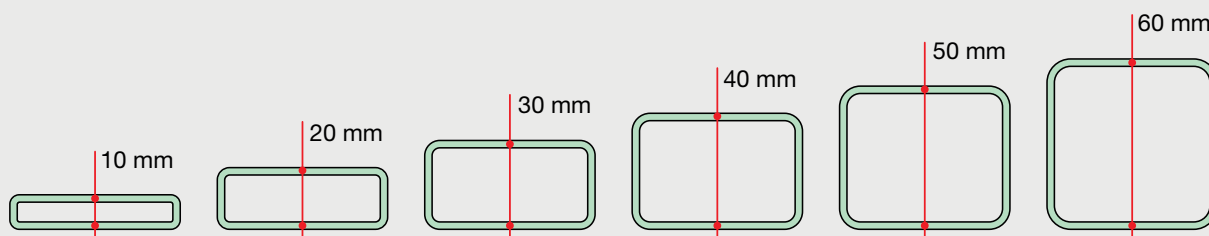
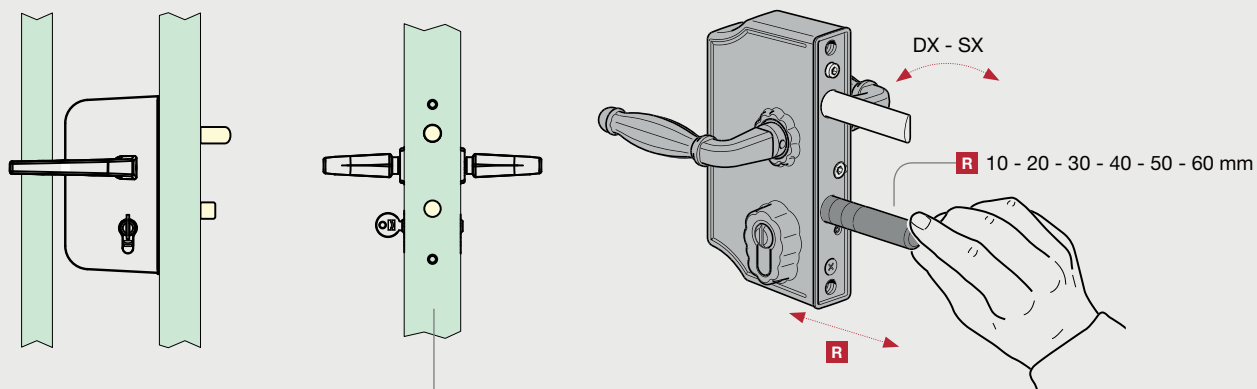
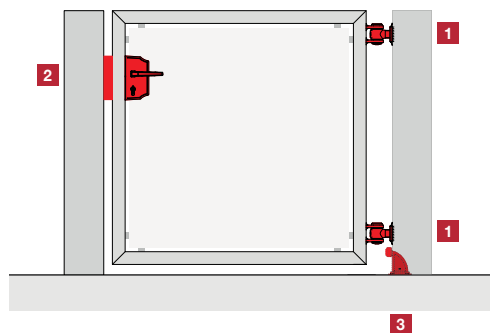

2



213



209



73



74



78

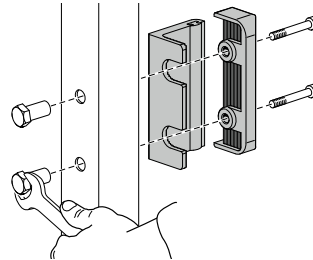

rotazione in asse
axis rotation

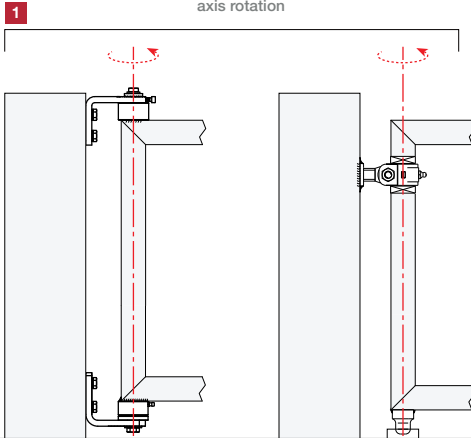

rotazione fuori asse
axis out rotation

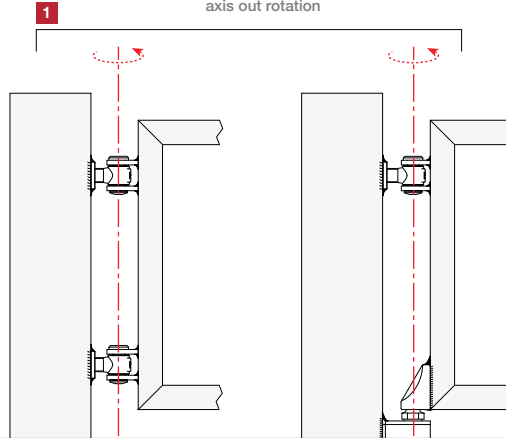

rotazione fuori asse per apertura a 180°
off-axis rotation for 180 degree opening

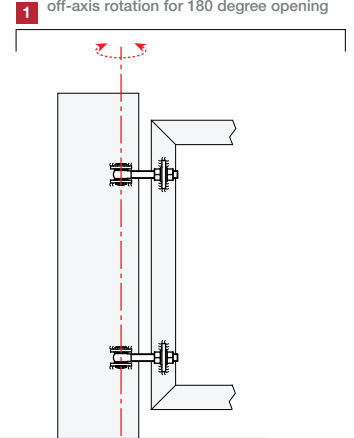

3

ARRESTI DI FINE CORSA / RUNAWAY STOPS

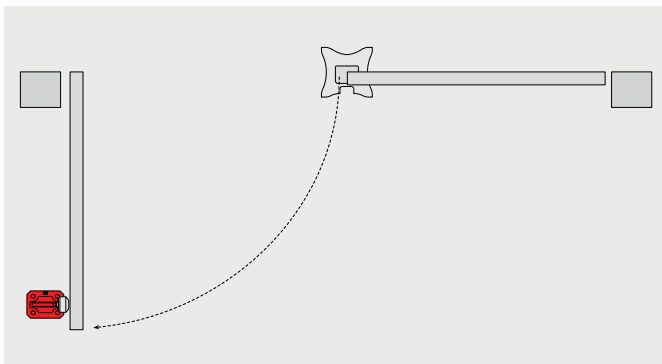

201 TRIS



PORTONI SCORREVOLI / SLIDING DOORS

Comunello offre una gamma di accessori atta a realizzare una molteplice gamma di portoni scorrevoli industriali. I carrelli, le monorotaie e le staffe di supporto sono disponibili nelle versioni Mini Piccole e Grandi a seconda della dimensione e della portata del portone stesso. I prodotti utilizzati per la realizzazione dei portoni scorrevoli, tutti testati HTC, forniscono al costruttore una garanzia di valore e di affidabilità.

Comunello offers a wide range of accessories for the manufacture of many different industrial sliding doors. Comunello trolleys, upper guides and support brackets are available in the three versions Mini, Small and Large, according to the size and loading capacity of the door. The products used for the construction of sliding doors are all HTC tested, thus providing the constructor with a guarantee of value and reliability.

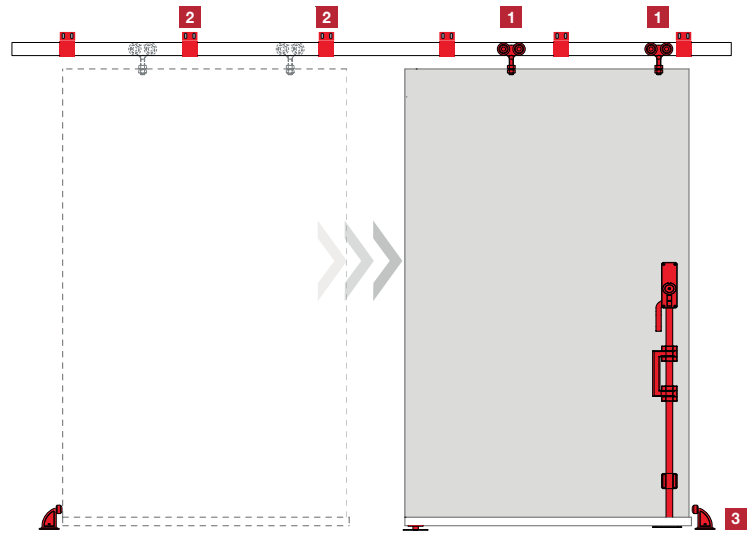

Art. 23 P

Art. 24 P

Art. 2 P



capacity
30 kg

Art. 4 P

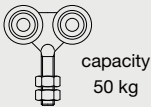

capacity
50 kg

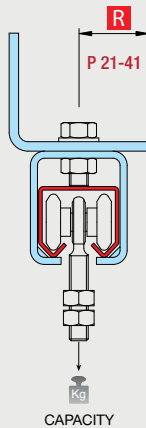

CAPACITY

Art. 23 M - 23 G

Art. 24 M - 24 G

Art. 2C M - 2C G

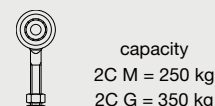

capacity
2C M = 250 kg
2C G = 350 kg

Art. 4C M - 4C G

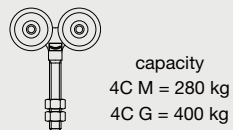

capacity
4C M = 280 kg
4C G = 400 kg

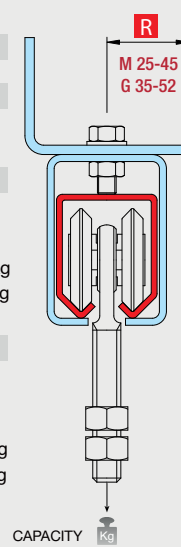

CAPACITY

Art. 22 P

Art. 24 P

Art. 2 P



capacity
30 kg

Art. 4 P

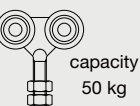

capacity
50 kg

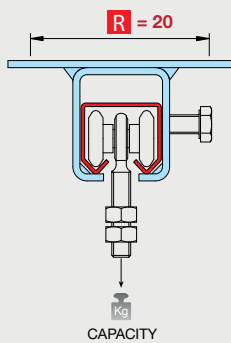

CAPACITY

Art. 22 M - 22 G

Art. 24 M - 24 G

Art. 2C M - 2C G



capacity
2C M = 250 kg
2C G = 350 kg

Art. 4C M - 4C G

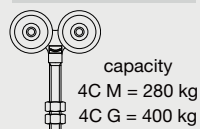

capacity
4C M = 280 kg
4C G = 400 kg

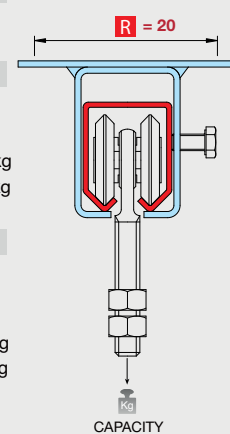

CAPACITY

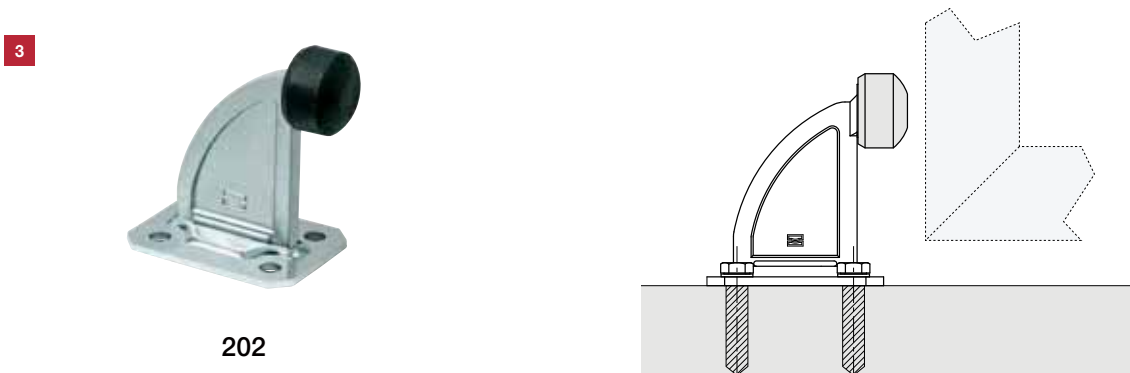
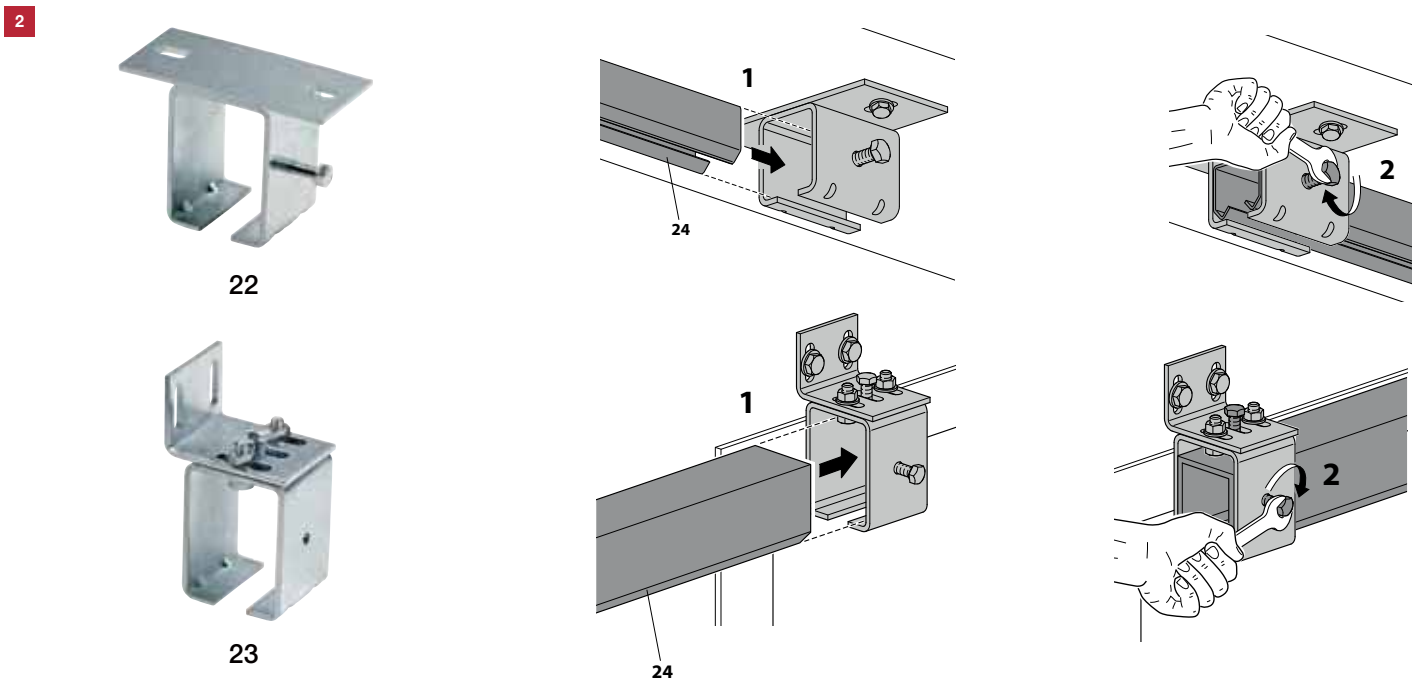
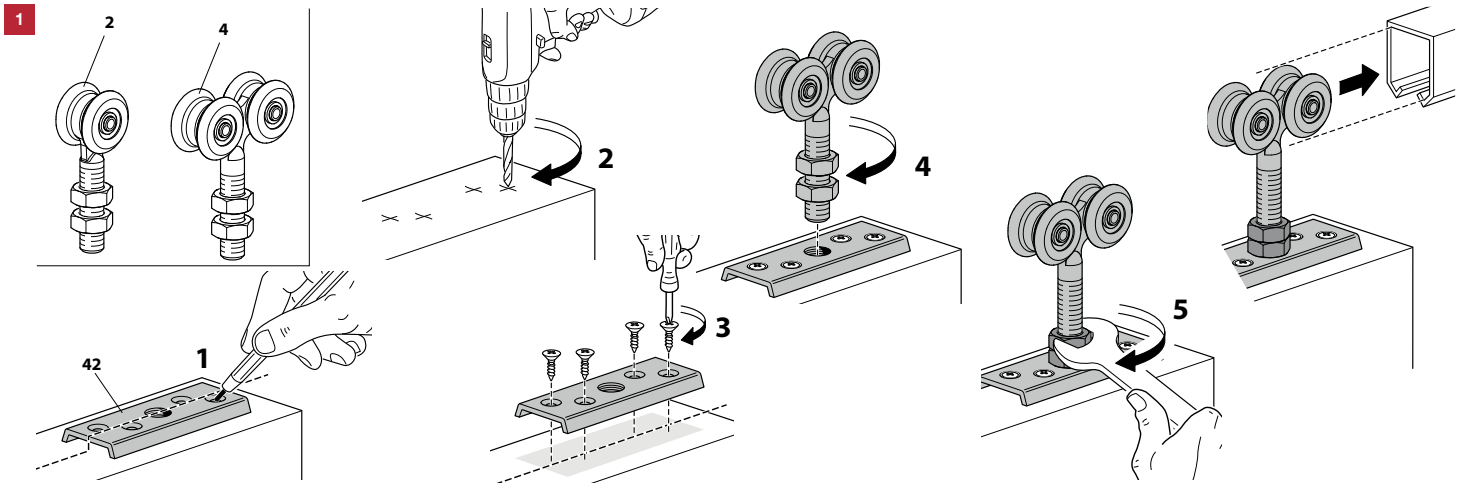



PORTONI AD ANTA / FOLDING DOORS

Comunello dispone di una vasta offerta di accessori per portoni industriali a libro offrendo molteplici soluzioni a seconda delle specifiche richieste del mercato. Tutti i prodotti sono testati HTC per garantire una elevata affidabilità per il costruttore. Oltre alle varie soluzioni, Comunello ha realizzato una gamma di accessori, racchiusa in un kit per dare una risposta ai produttori che necessitano di una soluzione veloce ed affidabile.

Comunello offers a wide range of accessories for industrial folding doors providing many different solutions according to the specific market requirements. All products are HTC tested in order to guarantee an high reliability to the constructor. Besides the wide range of products produced, we also offer a kit of accessories for those constructors who look for an easy and reliable solution.

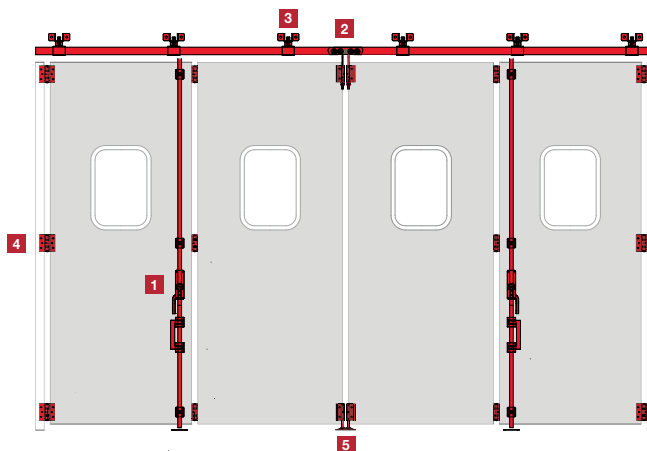

1 CARIGLIONI, ASTE E PASSANTI / LEVER BOLTS, RODS AND ROD GUIDES

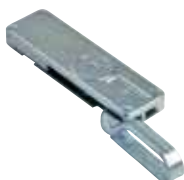

694 MC



691 G



699



695G



697G

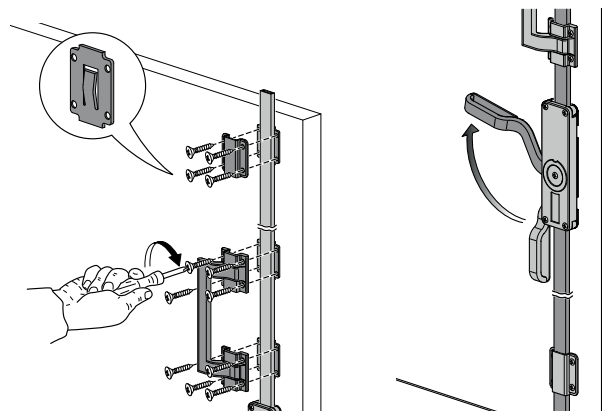

2 CARRELLI E PERNI / CARRIAGES



375



376

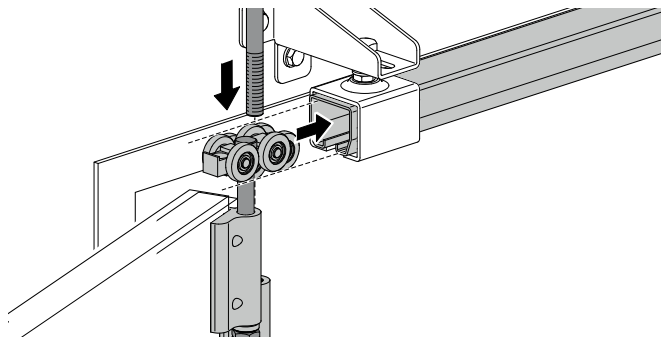

3 MONOROTAIE E STAFFE / GUIDES AND RODS

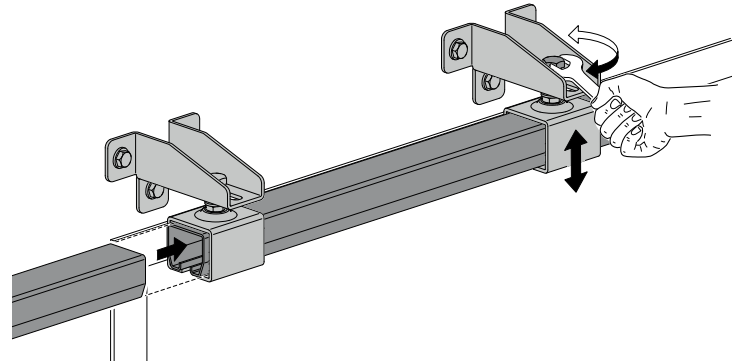

4 CERNIERE / HINGES

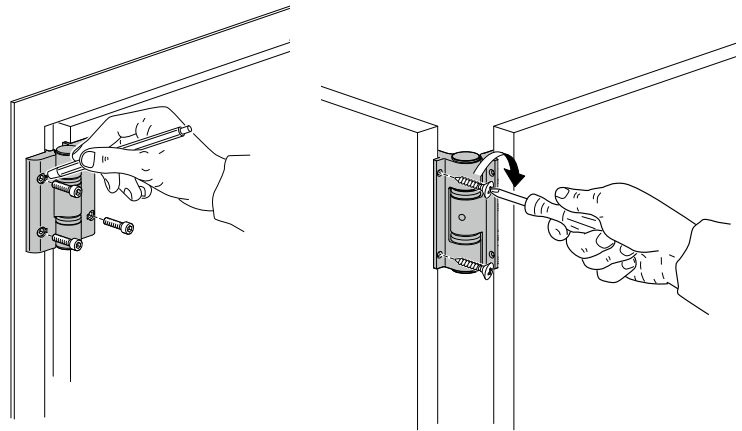

5 INCONTRI / STRIKE PLATES

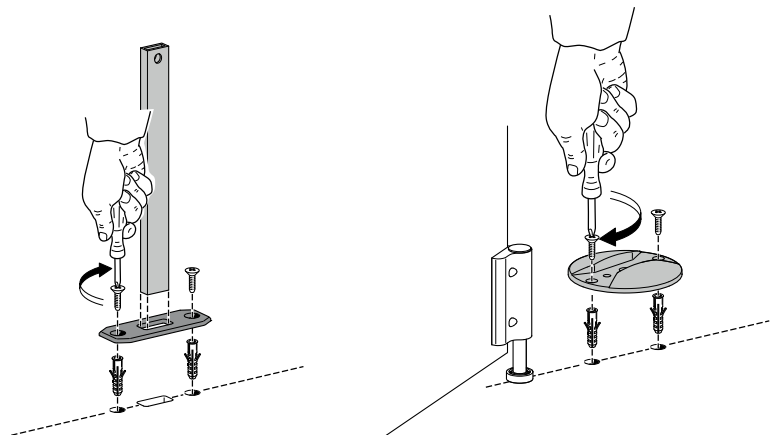



- **Carrello a 2 ruote**
- Trolley with 2 wheels
- Chariot à 2 galets
- Zweirädriger Rollenapparat

2

2	Piccolo Ø24	zinc	30 Kg	16	1,2	4,793

Categoria commerciale: 1C



- **Carrello a 2 ruote con cuscinetto**
- Trolley with two wheels and bearing
- Chariot à 2 galets avec roulement
- Zweirädriger Rollenapparat mit Kugellager

2C

2C	Medio Ø44	zinc	250 Kg	16	5,2	9,258

2C	Grande Ø54	zinc	350 Kg	16	10,82	15,449
----	------------	------	--------	----	-------	--------

Categoria commerciale: 1C



- **Carrello a 4 ruote**
- Trolley with four wheels
- Chariot à 4 galets
- Vierrädriger Rollenapparat

4

4	Piccolo Ø24	zinc	50 Kg	16	2,1	8,723

Categoria commerciale: 1C



- **Carrello a 4 ruote con cuscinetto**
- Trolley with four wheels and bearing
- Chariot à 4 galets avec roulement
- Vierrädriger Rollenapparat mit Kugellager

4C

PATENTED

4C	Medio Ø44	zinc	280 Kg	16	9,3	16,726

4C	Grande Ø54	zinc	400 Kg	16	19,6	30,101
----	------------	------	--------	----	------	--------

Categoria commerciale: 1C



- **Carrello a 2 ruote girevole**
- Turning trolley with two wheels
- Chariot à 2 galets pivotant
- Zweirädriger Schwenkrollenapparat

8

8	Piccolo Ø24	zinc	30 Kg	16	1,8	12,971

Categoria commerciale: 1C



- **Carrello a 2 ruote girevole con cuscinetti**
- Turning trolley with two wheels and bearings
- Chariot à 2 galets pivotant avec roulements
- Zweirädriger Schwenkrollenapparat mit Kugellagern

8C

PATENTED

8C	Medio Ø44	zinc	250 Kg	16	10,7	40,943

8C	Grande Ø54	zinc	350 Kg	16	19,9	47,471
----	------------	------	--------	----	------	--------

Categoria commerciale: 1C



- Carrello a 4 ruote girevole
- Turning trolley with four wheels
- Chariot à 4 galets pivotant
- Vierrädrieger Schwenkrollenapparat

10

Icona	Icona	Icona	Icona	Icona	Icona	Icona
10	Piccolo Ø24	zinc	50 Kg	16	2,7	17,589

Categoria commerciale: 1C



- Carrello a 4 ruote girevole con cuscinetti
- Turning trolley with four wheels and bearings
- Chariot à 4 galets pivotant avec roulements
- Vierrädrieger Schwenkrollenapparat mit Kugellagern

10C

PATENTED

Icona	Icona	Icona	Icona	Icona	Icona	Icona
10C	Medio Ø44	zinc	280 Kg	16	15,0	44,884

10C	Grande Ø54	zinc	350 Kg	16	27,0	60,660
-----	------------	------	--------	----	------	--------

Categoria commerciale: 1C



- Carrello a 4 ruote con cuscinetti e cerniera 3 ali
- Trolley with four wheels, bearings and 3 wings hinge
- Chariot avec 4 galets, roulements et paumelle à 3 ailes
- Vierrädrieger Rollenapparat mit Kugellager und 3-Lasche-Torband

16C

PATENTED

Icona	Icona	Icona	Icona	Icona	Icona	Icona
16C	Medio Ø44	zinc	280 Kg	16	14,3	32,383
16C	Grande Ø54	zinc	300 Kg	16	23,0	41,729

Categoria commerciale: 1C



- Carrello a 4 ruote con cuscinetti e cerniera 1 ala
- Trolley with four wheels, bearings and one wing hinge
- Chariot avec 4 galets, roulements et paumelle à 1 aile
- Vierrädrieger Rollenapparat mit Kugellager und 1 Lasche-Torband

20C

PATENTED

Icona	Icona	Icona	Icona	Icona	Icona	Icona
20C	Medio Ø44	zinc	280 Kg	16	12,4	26,695
20C	Grande Ø54	zinc	300 Kg	16	22,2	47,089

Categoria commerciale: 1C



- Supporto a soffitto per monorotaia art. 24
- Ceiling support for track art.24
- Support au plafond pour rail art.24
- Decke-Lager für Stahlprofil Artikel 24

22

Icona	Icona	Icona	Icona	Icona	Icona
22	Piccolo	zinc	10	3,5	11,584
22	Medio	zinc	10	4,6	13,637
22	Grande	zinc	6	4,5	17,338

Categoria commerciale: 1L



- Supporto a parete per monorotaia art. 24
- Wall support for track art.24
- Support au mur pour rail art.24
- Wand-Lager für Stahlprofil Artikel 24

23

Icona	Icona	Icona	Icona	Icona	Icona
23	Piccolo	zinc	10	3,7	12,032
23	Medio	zinc	10	6,2	15,045
23	Grande	zinc	6	4,0	22,502

Categoria commerciale: 1I



- **Monorotaia per carrello piccolo medio grande**
- Track for trolleys small-medium-large
- Rail pour chariots petit-moyen-grand
- Stahlprofil für Rollenaufhängung klein, medium, groß

24

						€
NEW	24	Piccolo L=3000	zinc	1	3,80	32,959
NEW	24	Medio L=3000	zinc	1	9,50	46,882
NEW	24	Grande L=3000	zinc	1	15,00	95,259
	24	Piccolo L=6000	zinc	1	7,5	62,779
	24	Medio L=6000	zinc	1	19,0	89,298
	24	Grande L=6000	zinc	1	30,0	181,446

Categoria commerciale: 11

NEW



- **Arresto di finecorsa per monorotaia 24**
- Runaway stop for Track 24
- Boutoir de fin de course pour rail 24
- Trendpuffer für Rollenaufhängung 24

25

						€
	25	Piccolo/Medio	zinc	12	1,7	8,766
	25	Grande	zinc	12	3,6	12,153

Categoria commerciale: 11



- **Perno inferiore con cerniera a 1 ala oliva in ottone**
- Bottom pivot with 1 wing hinge and brass roller
- Pivot inférieur avec paumelle à 1 aile et rouleau en laiton
- Unteres Führungsband mit 1-Lasche und Führungsrolle aus Messing

26

						€
	26	Medio	zinc	16	5,7	24,260
	26	Grande	zinc	16	7,6	30,330

Categoria commerciale: 1L



- **Perno inferiore con cerniera a 3 ali oliva ottone**
- Bottom pivot with 3 wings hinge and brass roller
- Pivot inférieur avec paumelle à 3 ailes et rouleau en laiton
- Unteres Führungsrolle mit 3-Lasche und Führungsrolle aus Messing

28

						€
	28	Medio	zinc	16	7,8	24,260
	28	Grande	zinc	16	9,0	30,330

Categoria commerciale: 1L



- **Perno filettato oliva in ottone**
- Threaded pivot with brass roller
- Pivot taraudé avec rouleau en laiton
- Bolzen mit Gewinde und Führungsrolle aus Messing

30

						€
	30-25	Ø25	zinc	20	3,0	9,095

Categoria commerciale: 1L



- **Piastra girevole con cuscinetto per carrelli**
- Turning plate with bearing for trolleys
- Platine pivotante avec roulement pour chariots
- Schwenkplatte mit Kugellager für Rollenapparate

34

						€
	34-M12	Medio	zinc	20	3,6	9,007
	34-M20	Grande	zinc	20	9,5	14,030

Categoria commerciale: 1L



- **Deviatore rullo in acciaio**
- Steel switcher with roller
- Déviateur en acier avec rouleau
- Ablenker mit Stahlführungsrolle

32

						€
	32-34	Ø34	zinc	20	5,2	7,686

Categoria commerciale: 1L



- **Guida inferiore oliva in ottone**
- Bottom guide with brass roller
- Guide inférieure avec rouleau en laiton
- Untere Führungsplatte mit Messing-Führungsrolle

36

Icon	Icon	Icon	Icon	Icon	Icon
36-25	Ø25	zinc	20	5,7	8,494
36-30	Ø30	zinc	20	6,5	10,012

Categoria commerciale: 1L



- **Carrello a 2 ruote**
- Trolley with 2 wheels
- Chariot avec 2 galets
- Zweirädriger Rollenapparat

38

Icon	Icon	Icon	Icon	Icon	Icon
38-24	Ø24	zinc	30 Kg	50	4,356

Categoria commerciale: 1C



- **Carrello a 2 ruote in nylon**
- Trolley with 2 nylon wheels
- Chariot avec 2 galets en nylon
- Rollenapparat mit 2-Nylon-Rollen

39

Icon	Icon	Icon	Icon	Icon	Icon
39-24	Ø24	zinc	30 Kg	50	3,920

Categoria commerciale: 1C



- **Carrello a 4 ruote**
- Trolley with 4 wheels
- Chariot avec 4 galets
- Vierdrüdriger Rollenapparat

40

Icon	Icon	Icon	Icon	Icon	Icon
40-24	Ø24	zinc	50 Kg	50	6,977

Categoria commerciale: 1C



- **Carrello a 4 ruote in nylon**
- Trolley with 4 nylon wheels
- Chariot avec 4 galets en nylon
- Vierrädriger Rollenapparat mit Nylon-Rollen

41

Icon	Icon	Icon	Icon	Icon	Icon
41-24	Ø24	zinc	50 Kg	50	6,955

Categoria commerciale: 1C



- **Piastrina per carrelli**
- Plate for trolleys
- Plaquette pour chariots
- Platte für Rollenapparat

42

Icon	Icon	Icon	Icon	Icon	Icon
42	Piccolo	zinc	50	2,5	1,059
42	Grande	zinc	50	2,5	1,212

Categoria commerciale: 1L



- Carrello a 2 ruote con staffa
- 2 Wheels trolley with bracket
- Chariot à 2 galets avec bride
- Zweirädriger Rollenapparat mit Befestigungsbügel

43

43-24	Ø24	zinc	30 Kg	100	7,5
3,002					

Categoria commerciale: 1C



- Carrello a 2 ruote con staffa lunga
- 2 Wheel trolley with long bracket
- Chariot à 2 galets avec bride longue
- Zweirädriger Rollenapparat mit langem Befestigungsbügel

44

44-24	Ø24	zinc	30 Kg	100	9,4
3,123					

Categoria commerciale: 1C



- Carrello a 2 ruote con staffa lunga zancata
- Trolley with 2 wheels and long bended bracket
- Chariot à 2 galets avec bride longue et courbée
- Zweirädriger Rollenapparat mit langem gekröpftem Befestigungsbügel

46

46-24	Ø24	zinc	30 Kg	100	9,4
4,094					

Categoria commerciale: 1C



- Carrello a 1 ruota con staffa
- Trolley with 1 wheel and bracket
- Chariot à 1 galet avec bride
- Einrädriger Rollenapparat mit Befestigungsbügel

48

48-24	Ø24	zinc	15 Kg	100	6,2
2,271					

Categoria commerciale: 1C



- Carrello a 2 ruote con staffa
- Trolley with 2 wheels and bracket
- Chariot à 2 galets avec bride
- Zweirädriger Rollenapparat mit Befestigungsbügel

50

50-24	Ø24	zinc	30 Kg	100	8,4
3,090					

Categoria commerciale: 1C



- Carrello a 2 ruote con staffa zancata
- Trolley with 2 wheels and bended bracket
- Chariot à 2 galets avec bride courbée
- Zweirädriger Rollenapparat mit gekröpftem Befestigungsbügel

52

52-24	Ø24	zinc	30 Kg	100	8,2
3,330					

Categoria commerciale: 1C



- Carrello a 4 ruote con staffa larga
- Trolley with 4 wheels and large bracket
- Chariot à 4 galets avec bride large
- Vierrädiger Rollenapparat mit breitem Befestigungsbügel

54

54-24	Ø24	zinc	50 Kg	100	16,0

Categoria commerciale: 1C



- Carrello a 4 ruote con staffa larga zancata
- Trolley with 4 wheels and large bended bracket
- Chariot à 4 galets avec bride large courbée
- Vierrädiger Rollenapparat mit gekröpftem breitem Befestigungsbügel

56

56-24	Ø24	zinc	50 Kg	100	16,1

Categoria commerciale: 1C



- Carrello a 4 ruote con staffa porta gancio
- Trolley with 4 wheels and hook holder bracket
- Chariot à 4 galets avec bride porte-crochet
- Vierrädiger Rollenapparat mit Einhängelbohrung

60

60-24	Ø24	zinc	50 Kg	50	9,6

Categoria commerciale: 1C



- Incontro in alluminio per serratura art. 73 e 74
- Aluminium strike for lock art. 73-74
- Gâche en aluminium pour serrure art. 73-74
- Schliessanschlag aus Aluminium für schloss art. 73-74

78

78	grezza	1	0,6	37,350
78	RAL 9005	1	0,7	42,395

Categoria commerciale: 1N



Ral 9005

- Serratura a montaggio rapido modello "Privato"
- Lock for gates "Residential" model easy to fix
- Serrure pour portail modèle "Standard" au montage rapide
- Schloss für Tore "Privat" Modell Einfach zum montieren

73

73-10	10	grezza	1	1,4
73-20	20	grezza	1	1,4
73-30	30	grezza	1	1,4
73-40	40	grezza	1	1,4
73-50	50	grezza	1	1,4
73-60	60	grezza	1	1,4
73-10	10	Ral 9005	1	1,4
73-20	20	Ral 9005	1	1,4
73-30	30	Ral 9005	1	1,4
73-40	40	Ral 9005	1	1,4
73-50	50	Ral 9005	1	1,4
73-60	60	Ral 9005	1	1,4

Categoria commerciale: 1N



Ral 9005

- Serratura a montaggio rapido modello "Industriale"
- Lock "Industrial" model easy to fix
- Serrure pour portail modèle "Industriel" au montage rapide
- Schloss "Industrie" Modell Einfach zum montieren

74

74-10	10	grezza	1	1,4
74-20	20	grezza	1	1,4
74-30	30	grezza	1	1,4
74-40	40	grezza	1	1,4
74-50	50	grezza	1	1,4
74-60	60	grezza	1	1,4
74-10	10	Ral 9005	1	1,4
74-20	20	Ral 9005	1	1,4
74-30	30	Ral 9005	1	1,4
74-40	40	Ral 9005	1	1,4
74-50	50	Ral 9005	1	1,4
74-60	60	Ral 9005	1	1,4

Categoria commerciale: 1N



1
Svitare la vite di fissaggio
Unscrew the fixing-screw
Dévisser la vis de fixation
Schrauben Sie die Befestigungsschraube auf



2
Regolare lo scrocco destro-sinistro
Adjust the right or left latch
Régler le pêne demi-tour droite-gauche
Eustellen Sie di Rechts- oder Linksrichtung des Schubriegels.



3
Chiudere la vite di fissaggio
Turn the fixing-screw
Fermez la vis de fixation
Ziehen Sie die Befestigungsschraube an



4
Avitare il grano di fissaggio
Screw the fixing-grain
Visser le grain de fixation
Schrauben Sie das Befestigungskorn an



5
Regolare lo scrocco
Adjust the latch
Régler le pêne demi-tour
Stellen Sie den Schubriegel ein



6
Aprire il grano di fissaggio
Open the fixing-grain
Ouvrez le grain de fixation
Machen Sie das Befestigungskorn auf

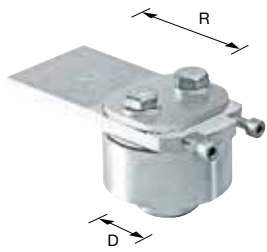

- Cardine superiore regolabile con piastra
- Adjustable upper hinge with plate
- Gond supérieur réglable avec platine
- Verstellbares oberes Torband mit Platte

85

	D		R				€
85M	Ø50	zinc	70-85	450 Kg*	4	3,4	27,557
85G	Ø70	zinc	90-105	650 Kg*	2	3,2	33,136

* valore portata a coppia L/H=1 / capacity of couple hinges L/H=1

Categoria commerciale: 1A

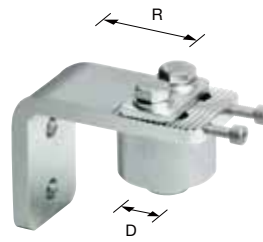

- Cardine superiore regolabile con piastra a L
- Adjustable upper hinge with L plate
- Gond supérieur réglable avec platine à L
- Verstellbares oberes Torband mit L-Platte

85L

	D		R				€
85L-M	Ø50	zinc	70-85	350 Kg*	2	2,4	34,85
85L-G	Ø70	zinc	90-105	500 Kg*	2	4,1	48,127

* valore portata a coppia L/H=1 / capacity of couple hinges L/H=1

Categoria commerciale: 1A

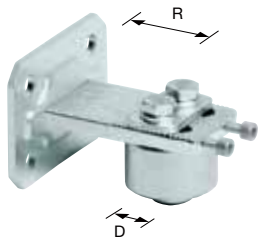

- Cardine superiore regolabile con piastra a fissare
- Adjustable upper hinge with plate to be screwed
- Gond supérieur réglable avec platine à visser
- Verstellbares oberes Torband mit Platte zum Anschrauben

85PST

	D		R				€
85PST-M	Ø50	zinc	70-85	350 Kg*	2	2,3	30,308
85PST-G	Ø70	zinc	90-105	500 Kg*	2	3,2	41,849

* valore portata a coppia L/H=1 / capacity of couple hinges L/H=1

Categoria commerciale: 1A



- Cardine superiore con cuscinetto e piastra
- Upper hinge with plate
- Gond supérieur avec platine
- Oberes Torband mit Platte

86P

	D		R				€
86P	Ø45	zinc	50-60	200 Kg*	4	2,5	24,260

* valore portata a coppia L/H=1 / capacity of couple hinges L/H=1

Categoria commerciale: 1A



- Cardine superiore pesante doppia regolazione e piastra a fissare
- Heavy upper hinge double adjustment and plate to be screwed
- Gond supérieur lourd double réglage platine à visser
- Schweres oberes Torband Doppelverstellung und Platte zum Anschrauben

85XL

KG 1100
L/H = 1

			R				€
85XL	Maxi	zinc	130-165	4000 Kg*	1	11,6	272,044

* valore portata a coppia L/H=1 / capacity of couple hinges L/H=1

Categoria commerciale: 1A

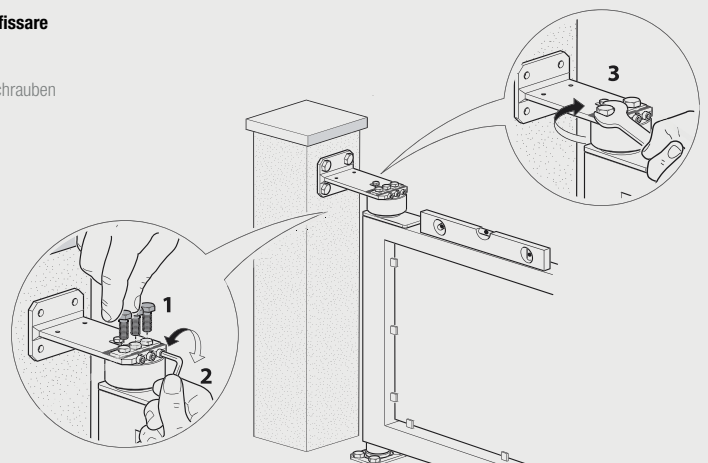

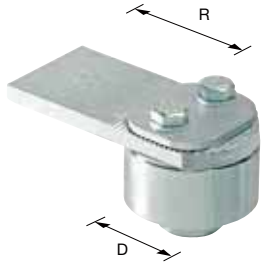

- Cardine superiore con piastra
- Upper hinge with plate
- Gond supérieur avec platine
- Oberes Torband mit Platte

86G

Icon	D	Icon	R	Icon	Icon	Icon	Icon
86G	Ø70	zinc	90-105	650 Kg*	2	3,2	33,365

* valore portata a coppia L/H=1 / capacity of couple hinges L/H=1

Categoria commerciale: 1A

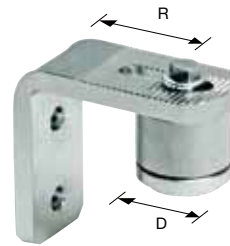

- Cardine superiore con piastra a L
- Upper hinge with L plate
- Gond supérieur avec platine à L
- Oberes Torband mit L-Platte

86L-P

Icon	D	Icon	R	Icon	Icon	Icon	Icon
86L-P	Ø45	zinc	50-80	200 Kg*	2	1,9	27,906

* valore portata a coppia L/H=1 / capacity of couple hinges L/H=1

Categoria commerciale: 1A

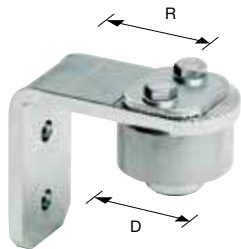

- Cardine superiore con piastra a L
- Upper hinge with L plate
- Gond supérieur avec platine à L
- Oberes Torband mit L-Platte

86L-G

Icon	D	Icon	R	Icon	Icon	Icon	Icon
86L-G	Ø70	zinc	90-105	500 Kg*	2	4,1	61,730

* valore portata a coppia L/H=1 / capacity of couple hinges L/H=1

Categoria commerciale: 1A

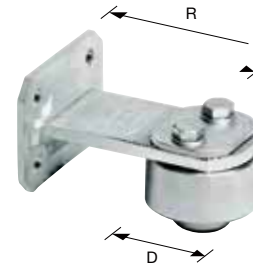

- Cardine superiore con piastra a fissare
- Upper hinge with plate to be screwed
- Gond supérieur avec platine à visser
- Oberes Torband mit Platte zum Anschrauben

86PST

Icon	D	Icon	R	Icon	Icon	Icon	Icon
86PST-G	Ø70	zinc	90-105	500Kg*	2	3,8	51,544

* valore portata a coppia L/H=1 / capacity of couple hinges L/H=1

Categoria commerciale: 1A



- Cardine inferiore con cuscinetto reggi spinta
- Bottom hinge with thrust bearing
- Gond inférieur avec roulement de butée
- Unteres Torband mit Drucklager

87

Icon	D	Icon	Icon	Icon	Icon	Icon
87P	Ø45	zinc	200 Kg*	4	1,6	17,895
87M	Ø50	zinc	450 Kg*	4	1,8	20,580
87G	Ø70	zinc	650 Kg*	2	2,0	27,906

* valore portata a coppia L/H=1 / capacity of couple hinges L/H=1

Categoria commerciale: 1A

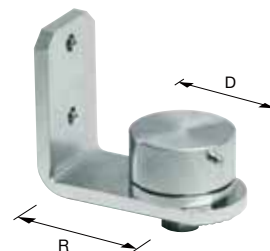

- Cardine inferiore con cuscinetto reggi spinta e piastra a L
- Bottom hinge with thrust bearing and L plate
- Gond inférieur avec roulement de butée et platine à L
- Unteres Torband mit Drucklager und L-Platte

87L

Icon	D	Icon	R	Icon	Icon	Icon	Icon
87L-P	Ø45	zinc	50-80	200 Kg*	4	2,9	25,832
87L-M	Ø50	zinc	50-85	350 Kg*	4	4,0	28,289
87L-G	Ø70	zinc	95-105	500 Kg*	2	4,2	43,705

* valore portata a coppia L/H=1 / capacity of couple hinges L/H=1

Categoria commerciale: 1A



- **Cardine inferiore con cuscinetto reggi spinta e piastra a fissare**
- Bottom hinge with thrust bearing and plate to be screwed
- Gond inférieur avec roulement de butée et platine à fixer
- Unteres Torband mit Drucklager und Platte zum Anschrauben

87PST

	Ø	Material	R	Capacity	QTY	Weight	Price
87PST-P	Ø45	zinc	10	200 Kg*	2	1,2	19,685
87PST-M	Ø50	zinc	10	350 Kg*	2	1,32	22,633
87PST-G	Ø70	zinc	10	500 Kg*	2	2,5	31,848

* valore portata a coppia L/H=1 / capacity of couple hinges L/H=1

Categoria commerciale: 1A



- **Cardine superiore perno quadro piastra a saldare**
- Upper hinge with square pin and plate to be welded
- Gond supérieur avec pivot carré et platine à souder
- Oberes Torband mit viereckigem Stift und Platte zum Schweißen

88

	D	Material	Capacity	QTY	Weight	Price
88-40	Ø33	zinc	200 Kg*	2	3,2	45,495
88-50	Ø43	zinc	450 Kg*	2	3,5	48,520
88-60	Ø52	zinc	650 Kg*	2	4,5	53,105

* valore portata a coppia L/H=1 / capacity of couple hinges L/H=1

Categoria commerciale: 1A



- **Cardine inferiore pesante con cuscinetto reggi spinta e piastra a fissare**
- Heavy bottom hinge with thrust bearing and plate to be screwed
- Gond inférieur lourd avec roulement de butée et platine à visser
- Schweres oberes Torband mit Drucklager und Platte zum Anschrauben

87XL

	Material	Capacity	QTY	Weight	Price
87XL	Maxi zinc	4000 Kg*	1	5,5	230,184

* valore portata a coppia L/H=1 / capacity of couple hinges L/H=1

Categoria commerciale: 1A

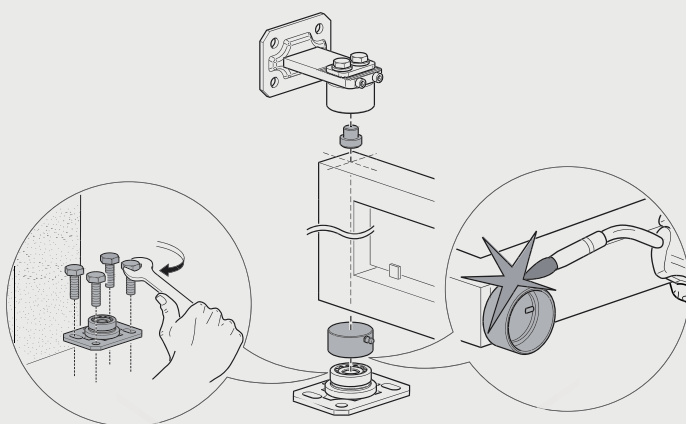

- **Cardine superiore perno quadro piastra a fissare a L**
- Upper hinge with square pin and L plate to be screwed
- Gond supérieur avec pivot carré et platine à L
- Oberes Torband mit viereckigem Stift und L-Platte zum Anschrauben

88L

	D	Material	R	Capacity	QTY	Weight	Price
88L-40	Ø33	zinc	90-105	200 Kg*	2	3,8	57,254
88L-50	Ø43	zinc	90-105	350 Kg*	2	4,1	64,383
88L-60	Ø52	zinc	90-105	500 Kg*	2	4,7	79,745

* valore portata a coppia L/H=1 / capacity of couple hinges L/H=1

Categoria commerciale: 1A

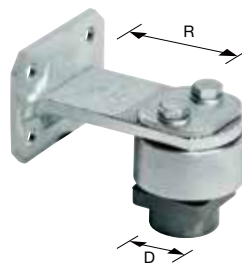

- **Cardine superiore perno quadro piastra a fissare**
- Upper hinge with square pin and plate to be screwed
- Gond supérieur avec pivot carré et platine à visser
- Oberes Torband mit viereckigem Stift und Platte zum Anschrauben

88PST

	D	Material	R	Capacity	QTY	Weight	Price
88PST-40	Ø33	zinc	90-105	200 Kg*	2	3,6	62,986
88PST-50	Ø43	zinc	90-105	350 Kg*	2	3,9	71,098
88PST-60	Ø52	zinc	90-105	500 Kg*	2	4,9	75,236

* valore portata a coppia L/H=1 / capacity of couple hinges L/H=1

Categoria commerciale: 1A



- Maxiperno inferiore
- Bottom big pin
- Pivot grand inférieur
- Unterer Maxibolzen

89

Icona	Materiali	D	Carico	Quantità	Spessore	Prezzo
99	99	Ø40	200 Kg*	2	2,6	30,341
99	99	Ø50	450 Kg*	2	2,8	31,389
99	99	Ø60	650 Kg*	2	3,4	34,872

* valore portata a coppia L/H=1 / capacity of couple hinges L/H=1

Categoria commerciale: 1A



- Cardine con ala cerniera
- Hinge with wing
- Gond avec aile paumelle
- Torband mit Lasche

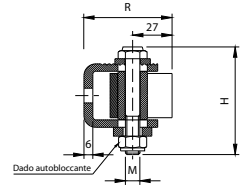

90

Icona	Materiali	R	Carico	Quantità	Spessore	Prezzo
99	99	H73	200 Kg*	20	8,1	12,741
99	99	H95	300 Kg*	10	6,1	16,683

* valore portata a coppia L/H=1 / capacity of couple hinges L/H=1

Categoria commerciale: 1A



- Cardine con ala cerniera e cuscinetto
- Hinge with wing and bearing
- Gond avec aile paumelle et roulement
- Torband mit Lasche und Kugellager

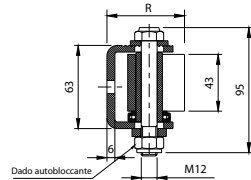

92G

Icona	Materiali	R	Carico	Quantità	Spessore	Prezzo
99	99	Grande	300 Kg*	10	6,0	19,718

* valore portata a coppia L/H=1 / capacity of couple hinges L/H=1

Categoria commerciale: 1A



- Cardine ala cerniera con piastra a fissare
- Hinge with wing and plate to be screwed
- Gond avec aile paumelle et platine à visser
- Torband mit Lasche und Platte zum Anschrauben

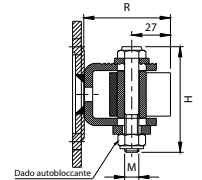

94

Icona	Materiali	R	Carico	Quantità	Spessore	Prezzo		
99	99	H73	zinc	63-73	200 Kg*	20	15,5	25,777
99	99	H95	zinc	62-72	300 Kg*	10	10,0	28,813

* valore portata a coppia L/H=1 / capacity of couple hinges L/H=1

Categoria commerciale: 1A



- Cardine ala cerniera e cuscinetto con piastra a fissare
- Hinge with wing, bearing and plate to be screwed
- Gond avec aile paumelle et roulement avec platine à visser
- Torband mit Lasche, Kugellager und Platte zum Anschrauben

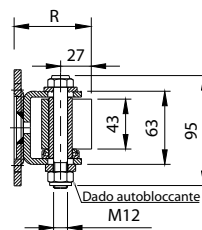

96G

Icona	Materiali	R	Carico	Quantità	Spessore	Prezzo		
99	99	zinc	Grande	62-72	300 Kg*	10	9,7	31,498

* valore portata a coppia L/H=1 / capacity of couple hinges L/H=1

Categoria commerciale: 1A



- Cardine con cavallotto
- Hinge with u bolt
- Gond avec crampillon
- Torband mit U-Bügel

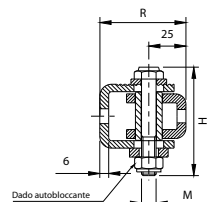

100

Icona	Materiali	M	R	Carico	Quantità	Spessore	Prezzo		
99	99	H73	M10	53-63	100 Kg*	20	7,2	9,837	
99	99	H73	M10	zinc	53-63	20	7,2	10,070	
99	99	H95	M12	52-62	200 Kg*	10	5,5	11,049	
99	99	H95	M12	zinc	52-62	200 Kg*	10	5,5	12,239

* valore portata a coppia L/H=1 / capacity of couple hinges L/H=1

Categoria commerciale: 1A



- Cardine con cavallotto e piastra a fissare
- Hinge with u bolt and plate to be screwed
- Gond avec crampillon et platine à visser
- Torband mit U-Bügel und Platte zum Anschrauben

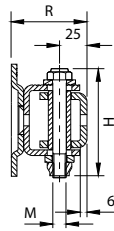

100PST

			M	R				€
100PST-P	zinc	H73	M10	64-74	100*	20	14,6	12,741
100PST-G	zinc	H95	M12	62-72	200*	10	9,1	16,683

* valore portata a coppia L/H=1 / capacity of couple hinges L/H=1

Categoria commerciale: 1A

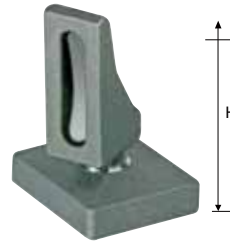

- Perno sferico e piastra
- Spherical pin and plate
- Pivot sphérique et platine
- Drehstift und Platte

105

								€
105-20		H98		210 Kg*	10		8,5	13,648

* valore portata a coppia L/H=1 / capacity of couple hinges L/H=1

Categoria commerciale: 1A



- Perno sferico e piastra a fissare
- Spherical pin and plate to be screwed
- Pivot sphérique et platine à visser
- Drehstift und Platte zum Anschrauben

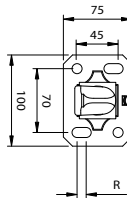

105PST

			R					€
105PST-20	zinc	H96	10	200 Kg*	5	4,5		16,071

* valore portata a coppia L/H=1 / capacity of couple hinges L/H=1

Categoria commerciale: 1A



- Perno sferico e piastra regolabile
- Spherical pin and adjustable plate
- Pivot sphérique et platine réglable
- Kugelstift und verstellbare Platte

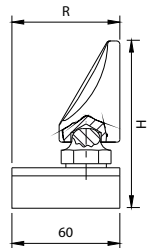

106

			H	R				€
106-20	zinc		124	50-70	150 Kg*	6	5,0	16,726
106-27	zinc		154	55-75	200 Kg*	2	3,0	40,266

* valore portata a coppia L/H=1 / capacity of couple hinges L/H=1

Categoria commerciale: 1A



- Perno sferico regolabile e piastra a fissare
- Adjustable spherical pin and plate to be screwed
- Pivot sphérique réglable et platine à visser
- Verstellbarer Kugelstift und Platte zum Anschrauben

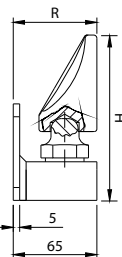

106PST

			H	R				€
106PST-20	zinc		124	55-75	150 Kg*	2	2,4	28,813
106PST-27	zinc		154	60-80	200 Kg*	2	3,7	57,309

* valore portata a coppia L/H=1 / capacity of couple hinges L/H=1

Categoria commerciale: 1A

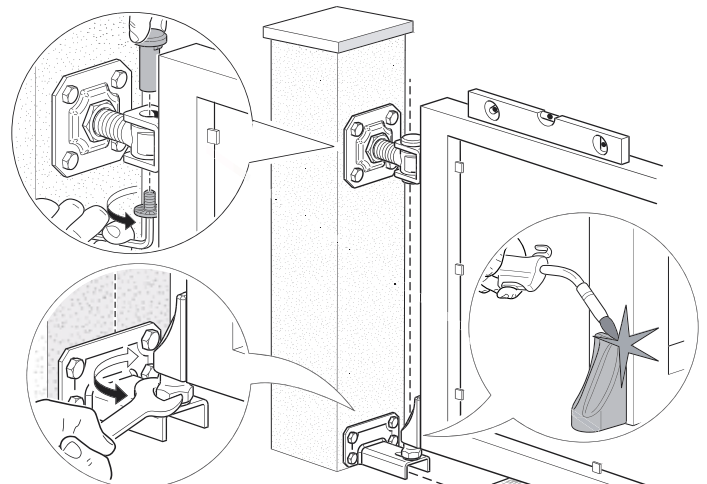



- **Perno inferiore**
- Bottom pin
- Pivot inférieur
- Unterer Drehstift

110

Icon	Material	Capacity	W	H	Price
		200 Kg*	20	4,1	2,915
🔥	zinc	200 Kg*	20	4,1	3,123
		300 Kg*	10	3,3	3,439
🔥	zinc	300 Kg*	10	3,3	3,679
🔥		450 Kg*	10	4,6	6,365

* valore portata a coppia L/H=1 / capacity of couple hinges L/H=1

Categoria commerciale: 1A



- **Piastra per perno inferiore**
- Plate for bottom pin
- Platine pour pivot inférieur
- Platte für unteren Drehstift

115

Icon	Material	W	H	Price
		20	8,10	2,216
🔥	zinc	20	8,10	2,577
		10	7,40	3,516
🔥	zinc	10	7,40	3,920
🔥		10	7,20	5,393

Categoria commerciale: 1A



- **Piastra base a fissare per perno inferiore**
- Base plate to be screwed for bottom pin
- Plaque de base à visser avec pivot inférieur
- Bodenplatte zum Anschrauben für unteren Drehstift

115PST

Icon	Material	R	Capacity	W	H	Price
🔥	zinc	10	150 Kg*	5	2,8	8,461
🔥	zinc	10	240 Kg*	5	2,7	9,466
🔥	zinc	10	300 Kg*	5	2,6	10,416

* valore portata a coppia L/H=1 / capacity of couple hinges L/H=1

Categoria commerciale: 1A

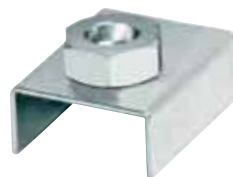

- **Piastra regolabile per perno inferiore**
- Adjustable plate for bottom pin
- Plaque réglable pour pivot inférieur
- Verstellbare Platte für unteren Drehstift

117

Icon	Material	H	R	Capacity	W	H	Price
🔥	zinc	48	25-45	125 Kg*	12	4,8	16,650
🔥	zinc	48	25-45	200 Kg*	12	5,0	22,971
🔥	zinc	51	25-45	250 Kg*	12	5,7	28,878

* valore portata a coppia L/H=1 / capacity of couple hinges L/H=1

Categoria commerciale: 1A

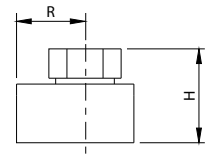

- **Piastra regolabile per perno inferiore a fissare**
- Adjustable plate for bottom pin to be screwed
- Plaque réglable pour pivot inférieur à visser
- Verstellbare Platte für unteren Drehstift zum Anschrauben

117PST

Icon	Material	H	R	Capacity	W	H	Price
🔥	zinc	48	30-50	125Kg*	2	1,5	29,762
🔥	zinc	48	30-50	200 Kg*	2	1,9	30,450
🔥	zinc	51	30-50	250 Kg*	2	1,7	35,964

* valore portata a coppia L/H=1 / capacity of couple hinges L/H=1

Categoria commerciale: 1A

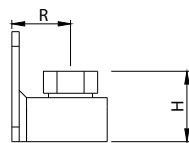

- **Cardine con cavallotto e bussola**
- Hinge with u-bolt and bush
- Gond avec crampillon et douille
- Torband mit U-Bügel und Buchse

120

Icon	Material	C	M	R	Capacity	W	H	Price
NEW	zinc	37	M16	50-80	95 Kg*	20	8.5	4,50
	zinc	37	M18	50-80	125 Kg*	20	9	5,765
	zinc	37	M20	50-80	150 Kg*	20	9	6,070
	zinc	49	M22	55-80	220 Kg*	10	7.2	8,189
	zinc	49	M24	55-85	225 Kg*	10	7.7	9,095
	🔥 Hs700	37	M20	50-80	150 Kg*	20	9	15,165
	🔥 Hs700	49	M24	55-85	225 Kg*	10	7.7	21,225

* valore portata a coppia L/H=1 / capacity of couple hinges L/H=1

Categoria commerciale: 1A

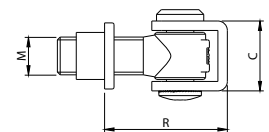

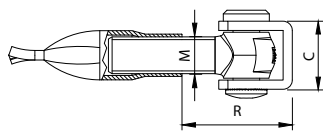

- Cardine con cavalletto a cementare
- Hinge to be cemented with u-bolt
- Gond à sceller avec crampillon
- Torband mit Mauerhülse und U-Bügel

125

		C	M	R				€	
NEW	125-M18	zinc	37	M18	45-85	125 Kg*	20	9.9	8,170
	125-M20	zinc	37	M20	45-85	150 Kg*	20	10.5	8,800
NEW	125-M22	zinc	49	M22	70-90	220 Kg*	10	7.6	11,420
	125-M24	zinc	49	M24	70-90	225 Kg*	10	8.1	14,554

* valore portata a coppia L/H=1 / capacity of couple hinges L/H=1

Categoria commerciale: 1A

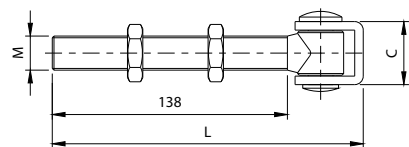

- Cardine con cavalletto a barra lunga filettata
- Hinge with long bar and u-bolt
- Gond avec barre long filetée et crampillon
- Torband mit langem Gewinde und U-Bügel

130

		C	M					€	
NEW	130-M18	zinc	37	M18	L=185	125 Kg	20	10.8	11,600
	130-M20	zinc	37	M20	L=182	150 Kg	20	12.1	13,036
NEW	130-M22	zinc	49	M22	L=187	220 Kg	10	9.3	16,300
	130-M24	zinc	49	M24	L=187	225 Kg	10	10.1	18,200

* valore portata a coppia L/H=1 / capacity of couple hinges L/H=1

Categoria commerciale: 1A

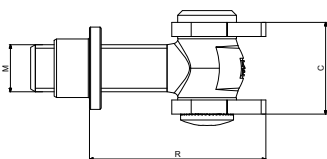

- Cardine con ali e bussola
- Hinge with wings and bush
- Gond avec ailes et douille
- Torband mit Lasche und Buchse

135

		C	M	R				€	
NEW	135-M16	zinc	39	M16	50-80	95 Kg*	20	7.9	5,500
	135-M18	zinc	39	M18	50-80	125 Kg*	20	7.9	6,365
	135-M20	zinc	39	M20	50-80	150 Kg*	20	9	6,671
	135-M22	zinc	53	M22	55-80	220 Kg*	10	7.1	9,226
	135-M24	zinc	53	M24	60-85	225 Kg*	10	8	12,850
	135-M27	zinc	60	M27	62-105	320 Kg*	10	11.5	17,458

* valore portata a coppia L/H=1 / capacity of couple hinges L/H=1

Categoria commerciale: 1A

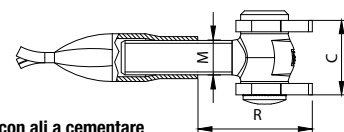

- Cardine con ali a cementare
- Hinge with wings to be cemented
- Gond à sceller avec ailes
- Torband mit Mauerhülse und Laschen

140

		C	M	R				€	
	140-M18	zinc	39	M18	45-85	125 Kg*	20	9.3	8,210
NEW	140-M20	zinc	39	M20	45-85	150 Kg*	20	9.5	9,500
	140-M22	zinc	53	M22	70-90	220 Kg*	10	7.9	11,551
NEW	140-M24	zinc	53	M24	70-90	225 Kg*	10	8.5	13,000
	140-M27	zinc	60	M27	85-105	320 Kg*	10	12.1	18,430

* valore portata a coppia L/H=1 / capacity of couple hinges L/H=1

Categoria commerciale: 1A

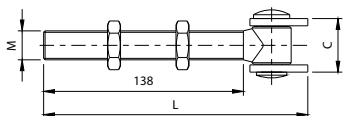

- Cardine con ali a barra lunga filettata
- Hinge with long bar and wings
- Gond avec barre long filetée et ailes
- Torband mit langem Gewinde und Laschen

150

		C	M					€	
	150-M18	L=185	zinc	39	M18	125 Kg*	20	9.5	11,202
NEW	150-M20	L=182	zinc	40	M20	150 Kg*	20	11	12,200
	150-M22	L=187	zinc	53	M22	220 Kg*	10	9.5	16,148
NEW	150-M24	L=187	zinc	53	M24	225 Kg*	10	10	17,500

* valore portata a coppia L/H=1 / capacity of couple hinges L/H=1

Categoria commerciale: 1A



- Piastra "Rustica" con dado regolabile
- Plate "Rustica" with adjustable nut
- Platine "Rustica" avec écrou réglable
- Platte "Rustica" mit verstellbarer Mutter

154

						€
	154-M18	zinc		10	4.8	10,612
	154-M20	zinc		10	4.8	11,529
	154-M22	zinc		10	4.8	12,741
	154-M24	zinc		10	4.8	13,648
	154-M27	zinc		10	5.5	16,683

Categoria commerciale: 1A

PATENTED

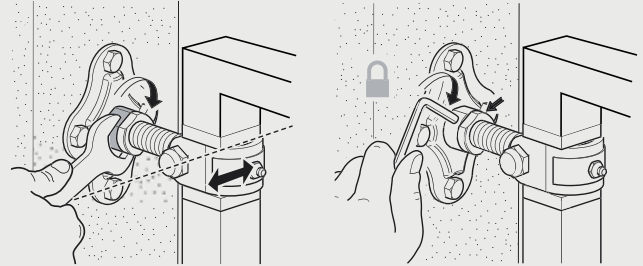
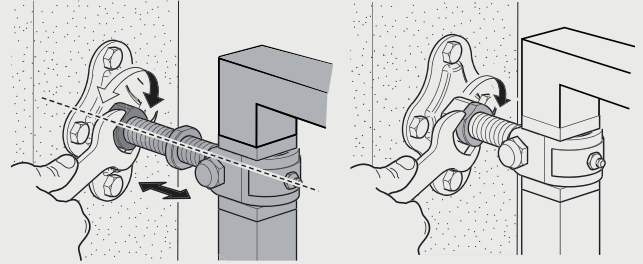
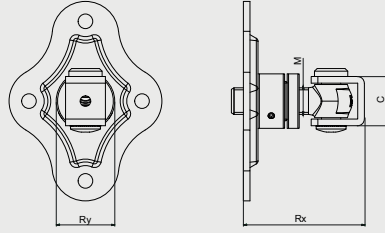

- Cardine con cavalletto e Piastra "Rustica" doppia regolazione su 2 assi x - y
- Hinge with u-bolt and Plate "Rustica" double adjustment on 2 axis x-y
- Gond avec crampillon et Platine "Rustica" avec double réglage sur les axes x-y
- Torband mit U-Bügel und Platte "Rustica" 2 Achsen x-y Doppelverstellung

154R-CV

		C	M	Ry	Rx				€
154R-CV-M18	zinc	37	M18	82-96	10	125 kg*	20	20,36	33,038
154R-CV-M20	zinc	37	M20	87-96	10	150 kg*	20	20,36	33,365
154R-CV-M22	zinc	49	M22	94-103	10	220 kg*	10	13,5	33,475
154R-CV-M24	zinc	49	M24	95-108	10	225 kg*	10	13,8	33,758

* valore portata a coppia L/H=1 / capacity of couple hinges L/H=1

Categoria commerciale: 1A

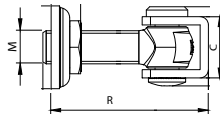

- Cardine con cavalletto e dado regolabile
- Hinge with u-bolt and adjustable nut
- Gond avec crampillon et écrou réglable
- Torband mit U-Bügel und verstellbare Mutter

155B

		C	M	R				€
NEW 155B-M16	zinc	37	M16	60-95	95 Kg*	20	10	7,56
155B-M18	zinc	37	M18	60-95	125 Kg*	20	10,5	7,577
155B-M20	zinc	37	M20	60-95	150 Kg*	20	11	9,095
NEW 155B-M22	zinc	49	M22	65-100	220 Kg*	10	8,3	13,63
155B-M24	zinc	49	M24	65-100	225 Kg*	10	8,8	13,648

* valore portata a coppia L/H=1 / capacity of couple hinges L/H=1

Categoria commerciale: 1A

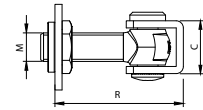

- Cardine con cavalletto, piastra tonda e dado regolabile
- Hinge with u-bolt, round plate and adjustable nut
- Gond avec crampillon, platine ronde et écrou réglable
- Torband mit U-Bügel, runde Platte und verstellbare Mutter

155

		C	M	R				€
NEW 155-M16	zinc	37	M16	55-90	95 Kg*	20	10	7,56
155-M18	zinc	37	M18	55-90	125 Kg*	20	10,5	7,577
155-M20	zinc	37	M20	55-90	150 Kg*	20	11	9,095
NEW 155-M22	zinc	49	M22	65-95	220 Kg*	10	8,3	13,63
155-M24	zinc	49	M24	65-100	225 Kg*	10	8,8	13,648

* valore portata a coppia L/H=1 / capacity of couple hinges L/H=1

Categoria commerciale: 1A

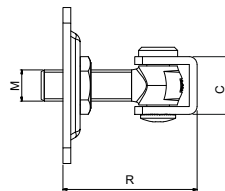

- Piastra "Rettangolare" con dado regolabile
- Plate "Rettangolare" with adjustable nut
- Platine "Rettangolare" avec écrou réglable
- Platte "Rettangolare" mit verstellbarer Mutter

157CV

		C	M	R				€
157CV-M18	zinc	37	M18	65-95	125 kg*	20	13.5	13,648
157CV-M20	zinc	37	M20	65-95	150 kg*	20	13.6	14,554
157CV-M22	zinc	49	M22	70-100	220 kg*	10	9.5	20,930
157CV-M24	zinc	49	M24	70-105	225 kg*	10	10	23,659

Categoria commerciale: 1A

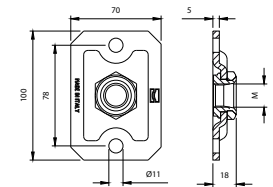

- Piastra "Rettangolare" con dado regolabile
- Plate "Rettangolare" with adjustable nut
- Platine "Rettangolare" avec écrou réglable
- Platte "Rettangolare" mit verstellbarer Mutter

157

								€
157-M18	zinc				10			3,28
157-M20	zinc				10			3,18
157-M22	zinc				10			3,30
157-M24	zinc				10			3,26

Categoria commerciale: 1A



- Cardine con ali e piastra "rettangolare" con dado regolabile
- Hinge with wings and Plate "Rettangolare" with adjustable nut
- Gond avec ailes et platine "Rettangolare" avec écrou réglable
- Torband mit Laschen und platte "Rettangolare" mit verstellbarer Mutter

157AL

		C	M	R				€
157-AL-M18	zinc	39	M18	65-95	125 kg*	20	14,5	13,495
157-AL-M20	zinc	39	M20	65-95	150 kg*	20	15,3	14,859
157-AL-M22	zinc	53	M22	70-100	220 kg*	10	10,2	21,225
157-AL-M24	zinc	53	M24	70-105	225 kg*	10	11,3	23,954

Categoria commerciale: 1A

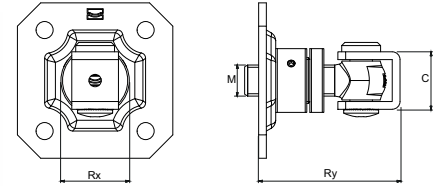

- Piastra "Quadrata" doppia regolazione su 2 assi x - y
- Plate "Quadrata" double adjustment on 2 axis x-y
- Platine "Quadrata" double réglage sur les axes x-y
- Platte "Quadrata" 2 Achsen x-y Doppelverstellung

159R-CV

PATENTED

		C	M	Ry	Rx			€	
159R-CV-M18	zinc	37	18	82-96	10	125 kg*	20	19,35	30,035
159R-CV-M20	zinc	37	20	87-96	10	150 kg*	20	19,35	30,330
159R-CV-M22	zinc	49	22	94-103	10	220 kg*	10	13	30,428
159R-CV-M24	zinc	49	24	95-108	10	225 kg*	10	13,3	30,690

* valore portata a coppia L/H=1 / capacity of couple hinges L/H=1

Categoria commerciale: 1A



- Piastra "Quadrata" con dado regolabile
- Plate "Quadrata" with adjustable nut
- Platine "Quadrata" avec écrou réglable
- Platte "Quadrata" mit verstellbarer Mutter

159

					€
NEW 159-M16	zinc	10	4,5	8,34	
159-M18	zinc	10	4,5	10,612	
159-M20	zinc	10	4,5	11,529	
159-M22	zinc	10	4,5	12,741	
159-M24	zinc	10	4,3	13,648	
159-M27	zinc	10	8,0	16,683	

Categoria commerciale: 1A

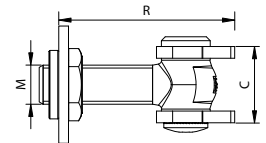

- Cardine con ali, piastra tonda e dado regolabile
- Hinge with wings, round plate and adjustable nut
- Gond avec ailes, platine ronde et écrou réglable
- Torband mit Laschen, runde Platte und verstellbare Mutter

160

		C	M	R			€	
NEW 160-M16	zinc	39	M16	55-90	95 Kg*	20	8,14	8,87
160-M18	zinc	39	M18	55-90	125 Kg*	20	8,14	8,887
NEW 160-M20	zinc	39	M20	55-90	150 Kg*	20	11	11,64
160-M22	zinc	53	M22	65-95	220 Kg*	10	7,44	11,650
NEW 160-M24	zinc	53	M24	65-100	225 Kg*	10	10	18,654
160-M27	zinc	60	M27	75-120	320 Kg*	10	10,50	18,834

* valore portata a coppia L/H=1 / capacity of couple hinges L/H=1

Categoria commerciale: 1A

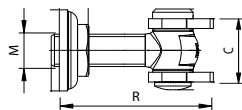

- Cardine con ali e dado regolabile
- Hinge with wings and adjustable nut
- Gond avec ailes et écrou réglable
- Torband mit Laschen und verstellbare Mutter

160B

		C	M	R			€	
NEW 160B-M16	zinc	39	M16	60-95	95 Kg*	20	8,14	8,87
160B-M18	zinc	39	M18	60-95	125 Kg*	20	8,14	8,887
NEW 160B-M20	zinc	39	M20	60-95	150 Kg*	20	11	11,64
160B-M22	zinc	53	M22	65-100	220 Kg*	10	7,44	11,650
NEW 160B-M24	zinc	53	M24	65-105	225 Kg*	10	10	18,654
160B-M27	zinc	60	M27	80-125	320 Kg*	10	10,50	18,834

* valore portata a coppia L/H=1 / capacity of couple hinges L/H=1

Categoria commerciale: 1A

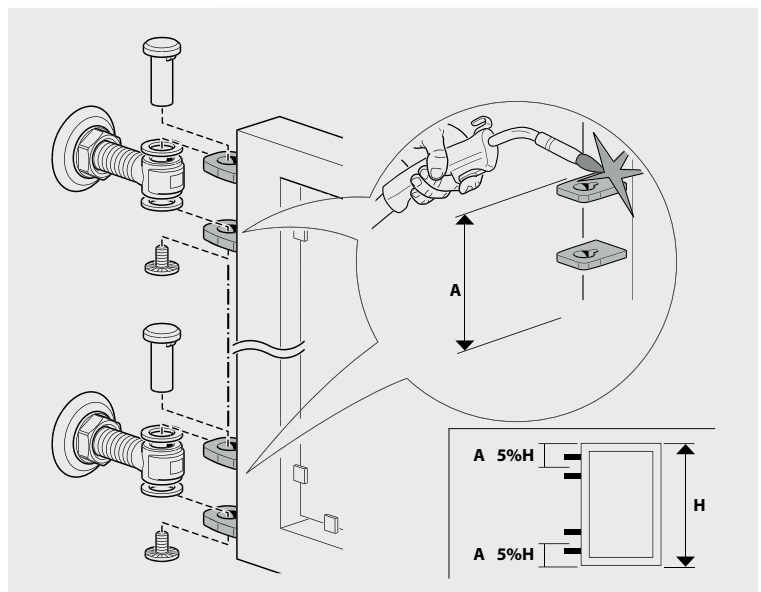

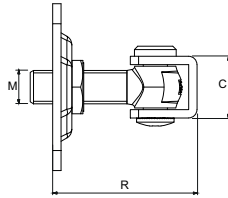

161

- Cardine con cavalletto e piastra con dado regolabile
- Hinge with u bolt and plate with adjustable nut
- Gond avec crampillon et platine avec écrou réglable
- Torband mit U-Bügel und Platte mit verstellbarer Mutter

		C	M	R				€	
NEW	161-M16	zinc	37	M16	65-95	95 Kg*	20	14,5	12,00
	161-M18	zinc	37	M18	65-95	125 Kg*	20	15	14,706
	161-M20	zinc	37	M20	65-95	150 Kg*	20	16,2	16,988
NEW	161-M22	zinc	49	M22	70-100	220 Kg*	10	9,3	21,64
	161-M24	zinc	49	M24	70-105	225 Kg*	10	11	23,659

* valore portata a coppia L/H=1 / capacity of couple hinges L/H=1

Categoria commerciale: 1A

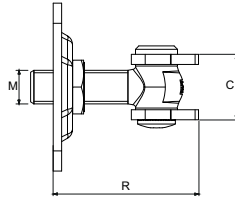

163

- Cardine con ali e piastra con dado regolabile
- Hinge with wings and plate with adjustable nut
- Gond avec ailes et platine avec écrou réglable
- Torband mit Laschen und Platte mit verstellbarer Mutter

		C	M	R				€	
NEW	163-M16	zinc	39	M16	65-95	95 Kg	20	14	13,00
	163-M18	zinc	39	M18	65-95	125 Kg	20	14,6	14,554
NEW	163-M20	zinc	39	M20	65-95	150 Kg	20	15,4	15,765
	163-M22	zinc	53	M22	70-100	220 Kg	10	11	18,200
	163-M24	zinc	53	M24	70-105	225 Kg	10	11,5	22,742
	163-M27	zinc	60	M27	80-125	320 Kg	10	18,3	29,959

* valore portata a coppia L/H=1 / capacity of couple hinges L/H=1

Categoria commerciale: 1A

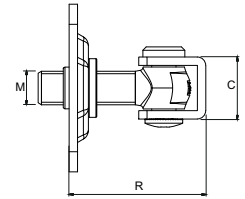

162

- Cardine con cavalletto e piastra con bussola
- Hinge with u bolt and plate with bush
- Gond avec crampillon et platine avec douille
- Torband mit U-Bügel und Platte mit Buchse

		C	M	R				€	
	162-M20	zinc	37	M20	60-90	150 Kg*	20	16	16,988
	162-M24	zinc	49	M24	65-100	225 Kg*	10	11,2	23,659

* valore portata a coppia L/H=1 / capacity of couple hinges L/H=1

Categoria commerciale: 1A

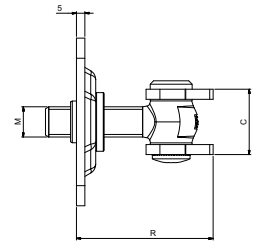

164

- Cardine con ali e piastra con bussola
- Hinge with wings and plate with bush
- Gond avec ailes et platine avec douille
- Torband mit Laschen und Platte mit Buchse

		C	M	R				€	
	164-M18	zinc	39	M18	62-90	125 Kg*	20	14	14,554
	164-M22	zinc	53	M22	70-95	220 Kg*	10	8,8	18,200
	164-M27	zinc	60	M27	75-117	320 Kg*	10	16,9	28,813

* valore portata a coppia L/H=1 / capacity of couple hinges L/H=1

Categoria commerciale: 1A



- Cardine maxi con ali e dado regolabile
- Hinge maxi with wings and adjustable nut
- Gond maxi avec ailes et écrou réglable
- Torband maxi mit Laschen und verstellbare Mutter

160XL

				€
160XL	zinc	2	7,0	181,970

Categoria commerciale: 1A

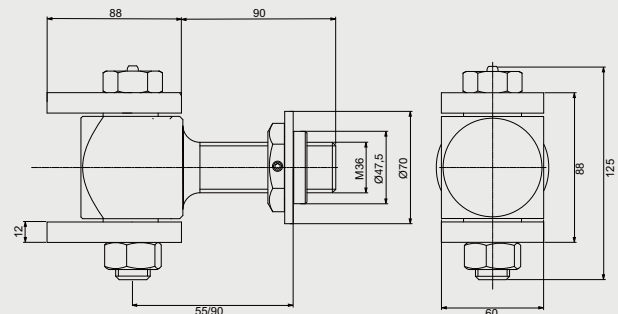

CARATTERISTICHE:

- Ingrassatore
- Perno anti-rotazione
- Vite M36 X3,5
- Regolazione (R) da 55 a 90 mm
- Vite di fissaggio

FEATURES:

- Grease gun
- No-losing screw
- Threaded Bar M36 X3,5
- Adjustment (R) from 55 to 90 mm
- Fixing screw

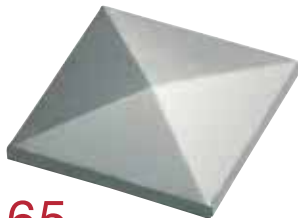

- Copri pilastro quadrato grezzo
- Square pillar cover raw
- Couvre pilastre carré brut
- Viereckiger Pfostendeckel

165

				€
165-30	30X30	50	1,5	0,524
165-40	40x40	50	2,2	0,535
165-50	50x50	50	3,2	0,579
165-60	60x60	50	4,3	0,666
165-80	80x80	50	6,7	0,972
165-100	100x100	50	9,3	1,234
165-120	120x120	25	7,8	1,583
165-150	150x150	25	11,0	2,511
165-200	200x200	20	15,2	4,880

Categoria commerciale: 1G

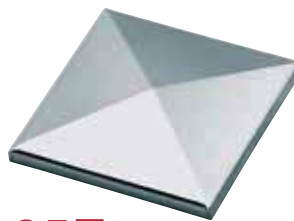

- Copri pilastro quadrato zincato
- Square pillar cover galvanized
- Couvre pilastre carré zingué
- Viereckiger Pfostendeckel Verzinkt

165Z

					€
165Z-30	zinc	30X30	50	1,5	0,535
165Z-40	zinc	40x40	50	2,2	0,557
165Z-50	zinc	50x50	50	3,0	0,644
165Z-60	zinc	60x60	50	4,3	0,819
165Z-80	zinc	80x80	50	6,8	0,939
165Z-100	zinc	100x100	50	9,8	1,398
165Z-120	zinc	120x120	25	7,8	1,747
165Z-150	zinc	150x150	25	11,8	2,926
165Z-200	zinc	200x200	20	15,2	5,787

Categoria commerciale: 1G

NEW



- Copri pilastro rettangolare grezzo
- Rectangular pillar cover raw
- Couvre pilier rectangulaire brut
- Rechteckig Pfostendeckel

165R

				€
165R-20x30	20x30	100	1,8	1,058
165R-20x40	20x40	100	2	1,059
165R-30x50	30x50	100	4,4	1,177
165R-30x60	30x60	100	4	1,352
165R-40x60	40x60	90	4,3	1,348
165R-40x80	40x80	100	6,7	1,901

Categoria commerciale: 1G

NEW



- Copri pilastro rettangolare zincato
- Rectangular pillar cover galvanized
- Couvre pilier rectangulaire zingué
- Rechteckig Pfostendeckel Verzinkt

165RZ

					€
165RZ-20x30	zinc	20x30	100	1,8	1,236
165RZ-20x40	zinc	20x40	100	2	1,271
165RZ-30x50	zinc	30x50	100	4,4	1,417
165RZ-30x60	zinc	30x60	100	4	1,598
165RZ-40x60	zinc	40x60	90	4,3	1,600
165RZ-40x80	zinc	40x80	100	6,7	2,264

Categoria commerciale: 1G



- Copri pilastro tondo
- Round pillar cover
- Couvre pilier rond
- Runder Pfostendeckel

165T

				€
165T-30	Ø30,3	50	1,1	0,819
165T-33	Ø33,8	50	1,2	0,819
165T-42	Ø42,7	50	1,8	0,884
165T-48	Ø48,5	50	2,2	0,939
165T-76	Ø76,5	50	4,8	1,376
165T-89	Ø89,2	50	6,0	1,539
165T-114	Ø114,8	25	5,1	3,144

Categoria commerciale: 1G

NEW



- Copri pilastro sagomato
- Shaped pillar cover
- Couvre pilier moulé
- Pfostendeckel

165S

					€
165S-50	50x50	10	1,35	10,647	
165S-60	60x60	6	1,25	14,489	
165S-80	80x80	8	3,30	21,189	
165S-100	100x100	4	2,90	30,698	
165S-120	120x120	6	3,40	38,520	
165S-150	150x150	4	5,40	46,649	

Categoria commerciale: 1G

NEW



- Copri pilastro quadrato in plastica
- Square plastic pillar cover
- Couvre pilier en plastique carré
- Viereckiger Pfostendeckel aus Kunststoff

165N

				€
165N-12	12X12	200	0,18	0,105
165N-15	15X15	200	0,23	0,107
165N-20	20X20	200	0,46	0,112
165N-25	25X25	100	0,31	0,155
165N-30	30X30	100	0,45	0,198
165N-35	35X35	50	0,295	0,343
165N-40	40X40	50	0,435	0,375
165N-45	45X45	150	1,42	0,380
165N-50	50X50	150	1,68	0,399
165N-60	60X60	100	2,85	0,723
165N-70	70X70	50	2,72	1,194
165N-80	80X80	50	1,61	1,395
165N-100	100X100	50	3,45	3,270

Categoria commerciale: 1G

NEW



- Copri pilastro rettangolare in plastica
- Rectangular plastic pillar cover
- Couvre pilier en plastique rectangulaire
- Rechteckig Pfostendeckel aus Kunststoff

165RN

				€
165RN - 15X30	15X30	50	1,35	0,229
165RN - 20X100	20X100	50	5,75	0,679
165RN - 20X30	20X30	200	7,30	0,159
165RN - 20X40	20X40	100	4,55	0,211
165RN - 20X50	20X50	100	5,80	0,311
165RN - 20X60	20X60	100	7,35	0,420
165RN - 25X40	25X40	100	5,30	0,321
165RN - 25X50	25X50	100	6,50	0,322
165RN - 30X120	30X120	50	8,35	1,381
165RN - 30X40	30X40	50	3,00	0,391
165RN - 30X50	30X50	50	3,75	0,395
165RN - 30X60	30X60	50	4,80	0,619
165RN - 30X80	30X80	100	11,90	0,766
165RN - 40X100	40X100	50	10,33	0,786
165RN - 40X120	40X120	50	15,30	1,240
165RN - 40X50	40X50	50	4,93	0,461
165RN - 40X60	40X60	50	5,30	0,714
165RN - 40X80	40X80	50	6,83	0,946
165RN - 50X100	50X100	50	14,35	1,141
165RN - 50X120	50X120	50	15,50	1,579
165RN - 50X150	50X150	50	22,50	3,837
165RN - 50X80	50X80	50	11,55	0,996

Categoria commerciale: 1G

NEW



- Copri pilastro tondo in plastica
- Round plastic pillar cover
- Couvre pilier en plastique rond
- Runder Pfostendeckel aus Kunststoff

165TN

				€
165TN-15	Ø15	200	0,18	0,097
165TN-20	Ø20	200	0,4	0,108
165TN-25	Ø25	200	0,56	0,141
165TN-30	Ø30	100	0,4	0,186
165TN-35	Ø35	100	0,52	0,225
165TN-40	Ø40	50	0,32	0,269
165TN-45	Ø45	50	0,46	0,472
165TN-50	Ø50	100	0,93	0,443
165TN-60	Ø60	100	1,3	0,621
165TN-70	Ø70	50	0,92	0,939
165TN-80	Ø80	50	0,75	1,043
165TN-100	Ø100	50	1,95	1,671

Categoria commerciale: 1G



- Battente d'arresto a fissare
- Stop batten to be fixed
- Battent d'arrêt à fixer
- Auflaufschuh zum Anschrauben

166

					€
166P	Piccolo	zinc	25	6,8	7,282
166G	Grande	zinc	10	4,8	13,036

Categoria commerciale: 1G



- **Battente d'arresto a cementare**
- Stop batten to be cemented
- Battent d'arrêt à sceller
- Auflaufschuh zum Ausbetonieren

167

167	zinc	10	12,2	13,789

Categoria commerciale: 1G



- **Battente d'arresto a cementare**
- Stop batten to be cemented
- Battent d'arrêt à sceller
- Auflaufschuh zum Ausbetonieren

169

169	zinc	25	7,8	4,247

Categoria commerciale: 1G



- **Battente d'arresto a cementare**
- Stop batten to be cemented
- Battent d'arrêt à sceller
- Auflaufschuh zum Ausbetonieren

170

170	25	8,4	4,269

Categoria commerciale: 1G



- **Battente d'arresto a fissare**
- Stop batten to be fixed
- Battent d'arrêt à fixer
- Auflaufschuh zum Anschrauben

171

171	zinc	10	8,20	7,883

Categoria commerciale: 1G

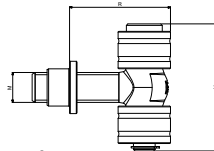

- **Cardine cilindrico con bussola**
- Cylindrical hinge with bush
- Gond cylindrique avec douille
- Zylindrischer Torband mit Buchse

172

172-M18	zinc	85	M18	43-72	125 Kg*	20	9,2	19,532
172-M20	zinc	85	M20	43-72	155 Kg*	20	11,5	20,231
172-M24	zinc	103	M24	46-79	240 Kg*	10	10,3	22,666

* valore portata a coppia L/H=1 / capacity of couple hinges L/H=1

Categoria commerciale: 1A

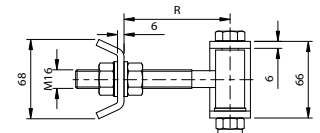

- **Cardine con cavalletto per apertura a 180°**
- Hinge with U-bolt for 180° opening
- Gond avec crampillon pour ouverture à 180°
- Torband mit U-Bügel für 180° Öffnung

174

174-M16	zinc	50-110	75 Kg*	10	9,8	24,587

* valore portata a coppia L/H=1 / capacity of couple hinges L/H=1

Categoria commerciale: 1A

175

- Cardine per apertura a 180°
- Hinge for 180° opening
- Gond pour ouverture à 180°
- Torband für 180° Öffnung

PATENTED

		L	H	R				€
175P	zinc	43	63	18	70 Kg*	8	7,9	17,895
175G	zinc	75	95	18	135 Kg*	6	8,6	19,718

* valore portata a coppia L/H=1 / capacity of couple hinges L/H=1
Categoria commerciale: 1A

176

- Cardine doppio corpo con cavallotto per apertura a 180°
- Hinge with double body and u bolt for 180° opening
- Gond avec double corps et crampillon pour ouverture à 180°
- Torband mit Doppelkörper und U-Bügel für 180° Öffnung

		R				€
176-M16	zinc	55-115	150 Kg*	10	20,0	45,692

* valore portata a coppia L/H=1 / capacity of couple hinges L/H=1
Categoria commerciale: 1A

178

- Cardine con ali per apertura a 180°
- Hinge with wings for 180° opening
- Gond avec ailes pour ouverture à 180°
- Torband mit Laschen für 180° Öffnung

		R	R			€	
178-M12	zinc	35-85	45-60	50 Kg*	10	5,6	9,095
178-M16	zinc	40-100	50-70	75 Kg*	10	8,1	11,529
178-M20	zinc	45-100	90-110	125 Kg*	10	14,9	14,554
178-M24	zinc	55-110	85-105	200 Kg*	10	22,2	30,330

* valore portata a coppia L/H=1 / capacity of couple hinges L/H=1
Categoria commerciale: 1A

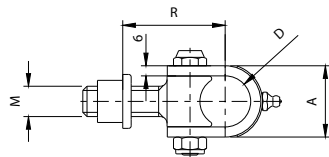
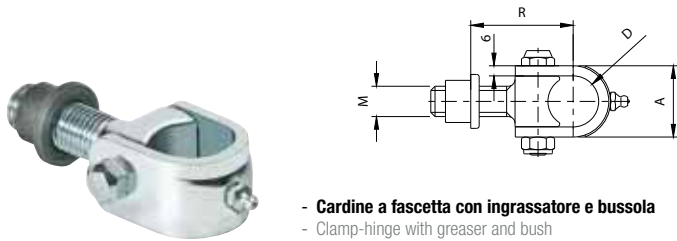

- Cardine a fascetta con ingrassatore e bussola
- Clamp-hinge with greaser and bush
- Gond à collier avec graisseur et douille
- Halseisenband mit Schmierbüchse und Buchse

180

		D	M	R				€
180-M18	zinc	Ø30	M18	45-70	100 Kg*	20	9,2	15,165
180-M22	zinc	Ø35	M22	45-75	160 Kg*	10	6,8	19,718
180-M27	zinc	Ø40	M27	55-95	260 Kg*	10	10,7	28,813

* valore portata a coppia L/H=1 / capacity of couple hinges L/H=1

Categoria commerciale: 1A

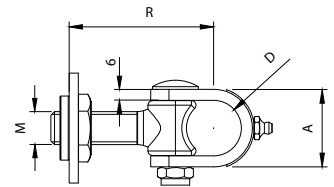
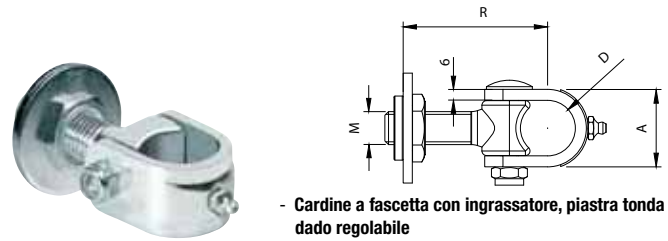

- Cardine a fascetta con ingrassatore, piastra tonda e dado regolabile
- Clamp-hinge with greaser, round plate and adjustable nut
- Gond à collier avec graisseur, platine ronde et écrou réglable
- Halseisenband mit Schmierbüchse, runde Platte und verstellbarer Mutter

182

		D	M	R				€
182-M18	zinc	Ø30	M18	55-80	100 Kg*	20	9,7	15,165
182-M22	zinc	Ø35	M22	64-90	160 Kg*	10	7,1	19,718
182-M27	zinc	Ø40	M27	75-105	260 Kg*	10	11,7	30,461

* valore portata a coppia L/H=1 / capacity of couple hinges L/H=1

Categoria commerciale: 1A

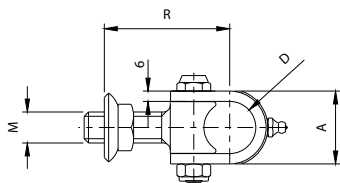
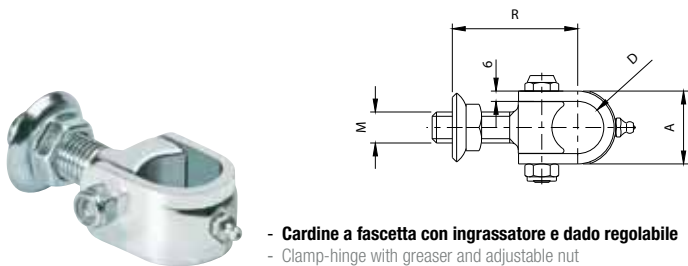

- Cardine a fascetta con ingrassatore e dado regolabile
- Clamp-hinge with greaser and adjustable nut
- Gond à collier avec graisseur et écrou réglable
- Halseisenband mit Schmierbüchse und verstellbarer Mutter

182B

		D	M	R				€
182B-M18	zinc	Ø30	M18	60-80	100 Kg*	20	9,7	15,165
182B-M22	zinc	Ø35	M22	65-95	160 Kg*	10	7,1	19,718
182B-M27	zinc	Ø40	M27	75-105	260 Kg*	10	11,7	30,461

* valore portata a coppia L/H=1 / capacity of couple hinges L/H=1

Categoria commerciale: 1A

NEW

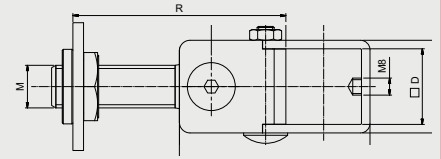
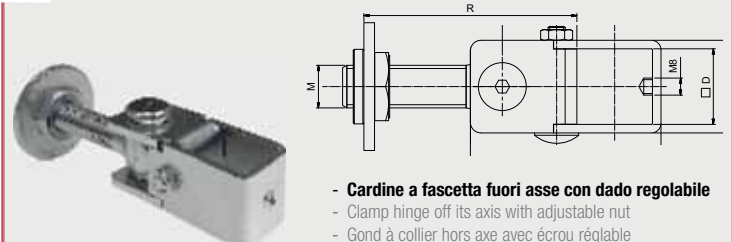

- Cardine a fascetta fuori asse con dado regolabile
- Clamp hinge off its axis with adjustable nut
- Gond à collier hors axe avec écrou réglable
- Halseisenband außßeraxial mit verstellbarer Mutter

183

		M	D	R				€
183-M18 30X30	zinc	M18	30,5	60-100	125 Kg*	20	15,8	26,439
183-M20 35X35	zinc	M20	35,5	60-100	150 Kg*	20	17	27,251
183-M24 40X40	zinc	M24	40,5	65-115	225 Kg*	10	14	32,904
183-M24 50X50	zinc	M24	50,5	65-115	225 Kg*	10	16,4	34,441

* valore portata a coppia L/H=1 / capacity of couple hinges L/H=1

Categoria commerciale: 1A

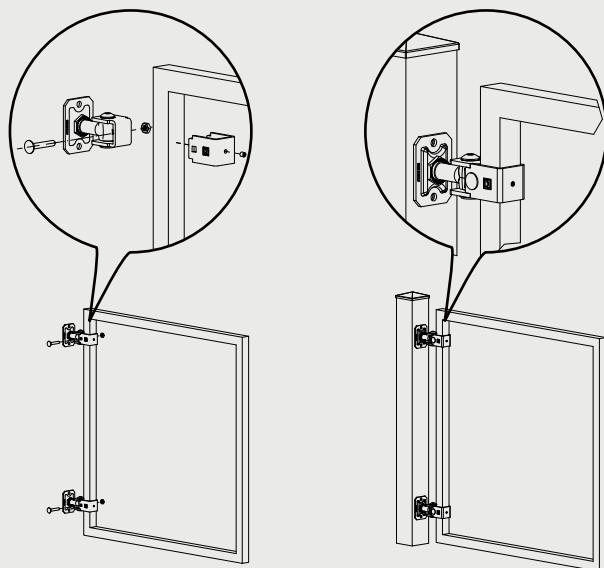

NEW

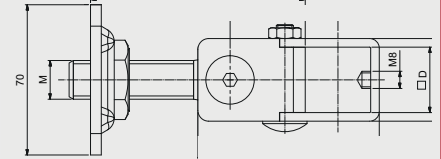
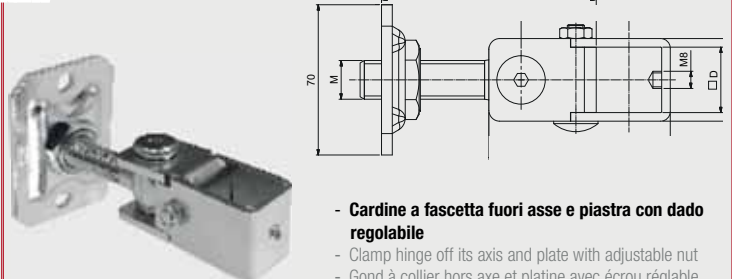

- Cardine a fascetta fuori asse e piastra con dado regolabile
- Clamp hinge off its axis and plate with adjustable nut
- Gond à collier hors axe et platine avec écrou réglable
- Halseisenband außßeraxial und Platte mit verstellbarer Mutter

187

		M	D	R				€
187-M18 30X30	zinc	M18	30,5	60-100	125 Kg*	20	19	26,901
187-M20 35X35	zinc	M20	35,5	60-100	150 Kg*	20	20	27,712
187-M24 40X40	zinc	M24	40,5	65-115	225 Kg*	10	15,8	32,741
187-M24 50X50	zinc	M24	50,5	65-115	225 Kg*	10	18	34,279

* valore portata a coppia L/H=1 / capacity of couple hinges L/H=1

Categoria commerciale: 1A

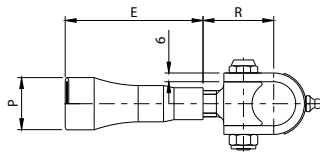

- Cardine a fascetta a cementare con ingrassatore
- Clamp-hinge with greaser to be cemented
- Gond à collier avec graisseur à sceller
- Halseisenband mit Schmierbüchse zum Ausbetonieren

184

		E	P	R				€
184-M18	zinc	95	38	40-70	100 Kg*	20	10,3	17,895
184-M22	zinc	100	38	45-80	160 Kg*	10	7,3	22,447
184-M27	zinc	110	44	55-95	260 kg*	10	10,5	31,542

* valore portata a coppia L/H=1 / capacity of couple hinges L/H=1

Categoria commerciale: 1A



- Corpo cardine a fascetta con ingrassatore per barre filettate
- Clamp-hinge body with greaser for threaded bars
- Corps gond à collier avec graisseur pour barres filettées
- Halseisenbandkörper mit Schmierbüchse für Profile mit Gewinde

185

								€
185-M18	zinc			100 Kg*	8	4,1		22,862
185-M22	zinc			160 Kg*	6	4,2		29,042
185-M27	zinc			260 Kg*	6	5,3		43,006

* valore portata a coppia L/H=1 / capacity of couple hinges L/H=1

Categoria commerciale: 1A

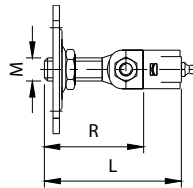

- Cardine a fascetta con ingrassatore e piastra con dado regolabile
- Clamp-hinge with greaser and plate with adjustable nut
- Gond à collier avec graisseur et platine avec écrou réglable
- Halseisenband mit Schmierbüchse und Platte mit verstellbarer Mutter

186

		L	M	R				€
186-M18	zinc	111	M18	60-85	100 Kg*	20	16,6	22,742
186-M22	zinc	126	M22	65-95	160 Kg*	10	10,3	26,684
186-M27	zinc	145	M27	80-110	260 kg*	10	16,7	39,425

* valore portata a coppia L/H=1 / capacity of couple hinges L/H=1

Categoria commerciale: 1A

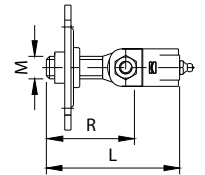

- Cardine a fascetta con ingrassatore e piastra con bussola
- Clamp-hinge with greaser and plate with bush
- Gond à collier avec graisseur et platine avec douille
- Halseisenband mit Schmierbüchse und Platte mit Buchse

188

		L	M	R				€
188-M18	zinc	111	M18	60-80	100 Kg*	20	16,6	22,742
188-M22	zinc	126	M22	65-85	160 Kg*	10	10,3	26,684
188-M27	zinc	145	M27	75-105	260 Kg*	10	16,7	39,425

* valore portata a coppia L/H=1 / capacity of couple hinges L/H=1

Categoria commerciale: 1A



- Dado per cardini
- Nut for hinges
- Écrou pour gonds
- Mutter für Torbänder

189

				€	
189-M18	zinc		50	1,4	0,415
189-M20	zinc		50	1,7	0,633
189-M22	zinc		50	1,9	0,808
189-M24	zinc		50	2,5	0,961
189-M27	zinc		50	4,5	2,129

Categoria commerciale: 1A



- Perno forato a base quadrata per cardini a fascetta
- Holed pivot with square base for clamp-hinges
- Pivot percé avec base carrée pour gonds à collier
- Anschweißstück mit Bohrungen und Quadrat-Fuß für Halseisenbänder

190

					€
190-30	Ø30	30x30x3	20	4,9	10,459
190-35	Ø35	35x35x3	10	4,0	11,497
190-40	Ø40	40x40x3	10	6,1	14,313

Categoria commerciale: 1A

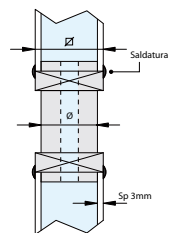



- Perno maggiorato forato a base quadrata per cardini a fascetta
- Oversize holed pivot with square base for clamp-hinges
- Pivot plus grand percé avec base carrée pour gonds à collier
- Grösser Anschweißstück mit Bohrungen und Quadrat-Fuß für Halseisenbänder

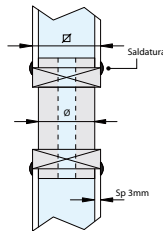

192

192-30	Ø30 35x35x3	20	5,8		13,800
192-35	Ø35 40x40x3	10	4,5		14,816
192-40	Ø40 50x50x3	10	7,6		17,436

Categoria commerciale: 1A



- Perno inferiore a base quadrata
- Bottom pivot with square base
- Pivot inférieur avec base carrée
- Lagerzapfen mit Quadrat-Fuß

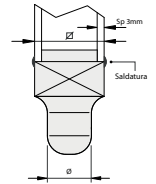

194

194-30	30x30x3	280 Kg*	20	3,7	6,223
194-40	40x40x3	550 Kg*	10	3,2	9,914
194-50	50x50x3	550 Kg*	10	4,5	13,953

* valore portata a coppia L/H=1 / capacity of couple hinges L/H=1

Categoria commerciale: 1A



- Piastra base inferiore a fissare con perno sferico
- Bottom ground plate to be fixed with spherical pivot
- Platine de base inférieure à fixer avec pivot sphérique
- Bodenplatte zum Anschrauben mit Kugelzapfen

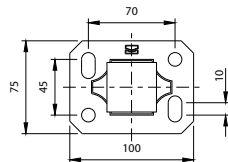

194PST

194PST-40x40	40x40	001	150 Kg*	5	3,7

* valore portata a coppia L/H=1 / capacity of couple hinges L/H=1

Categoria commerciale: 1A



- Perno forato a base tonda per cardini a fascetta
- Holed pivot with round base for clamp-hinges
- Pivot percé avec base ronde pour gonds à collier
- Anschweißstück mit Bohrungen und Rund-Fuß für Halseisenbänder

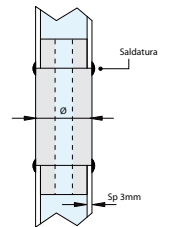

196

196-30	Ø30x3	20	5,9		7,370
196-35	Ø35x3	10	4,5		10,809
196-40	Ø40x3	10	7,7		11,671

Categoria commerciale: 1A

NEW

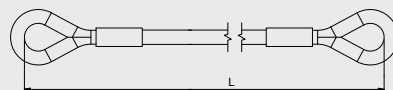

195

- Sicurezza anticaduta per cancelli a battente
- Safety cable for swinging gate anti downfall
- Cable anti-chute pour portail battent
- Fall-Schutz Kabel

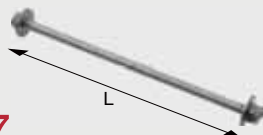

197

- Barra filettata per sicurezza anticaduta
- Threaded bar for anti fall cable
- Tige fileté pour cable anti-chute
- Gewindestange für Fall-Schutz Kabel

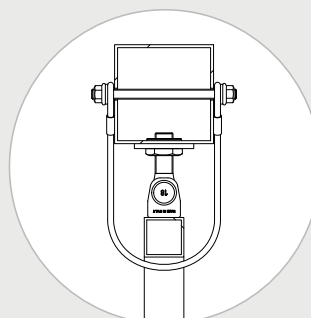

		L	Portata con cardine superiore Capacity with top hinge			
195-400	zinc	400	400	10	0,9	8,500
195-500	zinc	500	400	10	1,1	8,600
195-600	zinc	600	400	10	1,3	9,400
195-700	zinc	700	400	10	1,6	9,800
197		250		10	1,8	2,800

Categoria commerciale: 1G

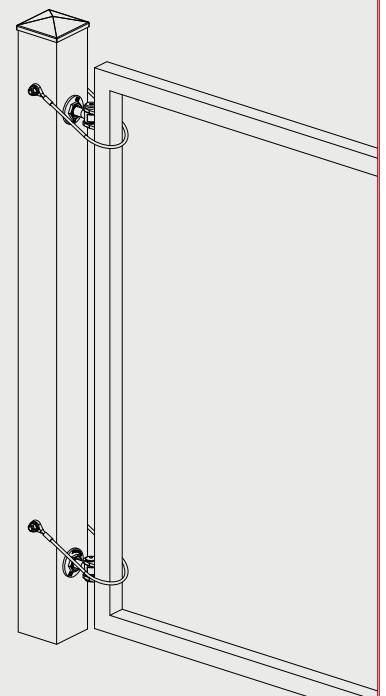



- **Perno inferiore a base tonda**
- Bottom pivot with round base
- Pivot inférieur avec base ronde
- Lagerzapfen mit Rund-Fuss

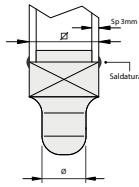

198

Icon	Icon	Icon	Icon	Icon	Icon
198-30	Ø30x3	280 Kg*	10	1,5	7,391
198-35	Ø35x3	350 Kg*	10	2,3	9,291
198-40	Ø40x3	550 kg*	10	2,8	10,023

* valore portata a coppia L/H=1 / capacity of couple hinges L/H=1

Categoria commerciale: 1A

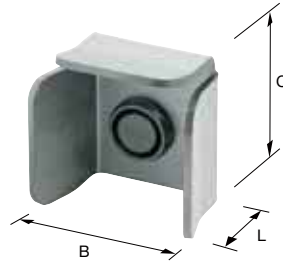

- **Incontro superiore con tappo ammortizzatore**
- Upper end with shock absorber cup
- Butée supérieure avec bouchon amortisseur
- Oberer Auflageschuh mit Schlusdämpfer

199

Icon	Icon	B	C	L	Icon	Icon	Icon
199-40	Piccolo	42	59	45	6	1,6	21,225
199-50	Medio	52	69	50	6	2,3	28,813
199-60	Grande	62	79	60	6	3,0	31,269

Categoria commerciale: 1G



- **Arresto di fine corsa**
- Runaway stop
- Boutoir de fin de course
- Torendpuffer

200

Icon	Icon	Icon	Icon	Icon	Icon
200P	H=96	zinc	30	7,9	6,867
200G	H=120	zinc	15	6,9	8,964

Categoria commerciale: 1G



- **Arresto di fine corsa con base a fissare**
- Runaway stop to be screwed
- Boutoir de fin de course avec base à visser
- Torendpuffer mit Befestigungsplatte zum Anschrauben

202

Icon	Icon	Icon	Icon	Icon	Icon
202	H=120	zinc	10	7,4	13,036

Categoria commerciale: 1G



- **Battente "Tris" a fissare tripla funzione**
- Strike plate to be fastened with triple function
- Butée à fixer triple fonction
- Aufaufschuh zur Befestigung mit dreifacher Funktion

201

Icon	Icon	Icon	Icon	Icon	Icon
201	H=132	zinc	2	2,8	31,488

Categoria commerciale: 1G

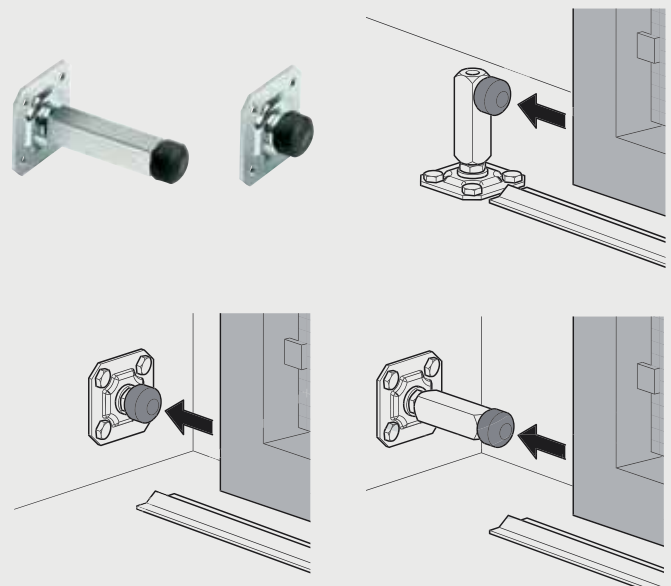



- **Arresto di fine corsa regolabile a fissare per cancelli ad anta**
- Adjustable runaway stop to be screwed for wing gates
- Boutoir de fin de course à visser réglable pour portails à vantaux
- Verstellbarer Torendpuffer zum Anschrauben für Flügeltore

202F-B

202F-B	H=130	zinc	70-115	4	6,4	53,400
Categoria commerciale: 1G						

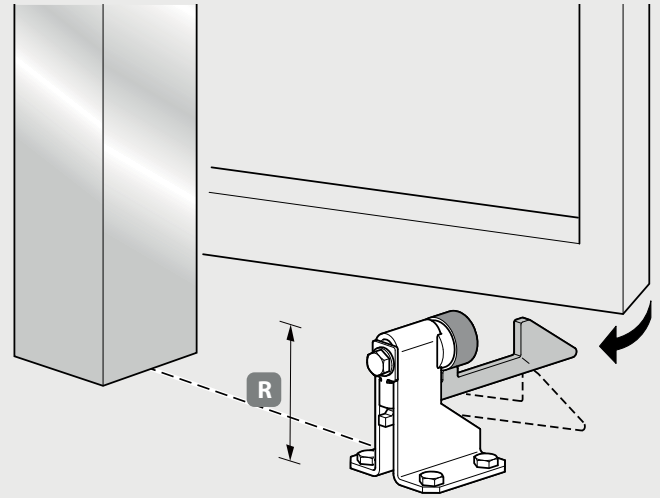

- **Arresto di fine corsa ammortizzato con base a fissare**
- Damped runaway stop to be screwed
- Boutoir de fin de course amorti avec base à visser
- Torendpuffer mit Platte zum Anschrauben

202F-A

202F-A	H=106	zinc	4	5,6	69,755	
Categoria commerciale: 1G						



- **Arresto di fine corsa regolabile a fissare**
- Adjustable runaway stop to be screwed
- Boutoir de fin de course à visser réglable
- Verstellbarer Torendpuffer zum Anschrauben

202F-C

202F-C	H=130	zinc	70-115	10	12,4	38,868
Categoria commerciale: 1G						



- **Maniglia in nylon**
- Nylon handle
- Béquille en nylon
- Nylon-Türdrücker

205

205	30-50	10	2,1	8,418
Categoria commerciale: 1H				



- **Maniglia in alluminio mod. "Sonia"**
- Aluminium handle "Sonia"
- Béquille en aluminium "Sonia"
- Aluminium-Türdrücker Modell "Sonia"

209

209	Ral 9005	30-50	20	5,6	18,659
209	argento/silver	30-50	20	5,5	19,914
Categoria commerciale: 1H					



- Incontro aperto regolabile con tappi ammortizzatori
- Open adjustable end with shock absorber cups
- Butée ouverte avec bouchons amortisseurs
- Verstellbarer geöffneter Auflageschuh mit Schlusdämpfern

203

		R			
203	zinc	80-150	2	5,8	73,238

Categoria commerciale: 1G

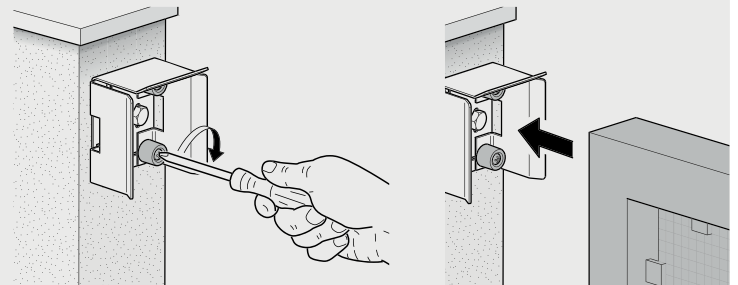
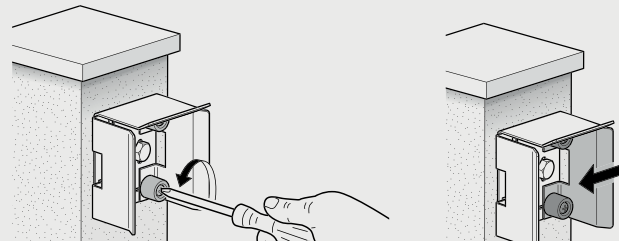

- Incontro chiuso regolabile con tappi ammortizzatori
- Closed adjustable end with shock absorber cups
- Butée fermée réglable avec bouchons amortisseurs
- Verstellbarer geschlossener Auflageschuh mit Schlusdämpfern

204

		R			
204	zinc	80-150	2	7,3	69,755

Categoria commerciale: 1G

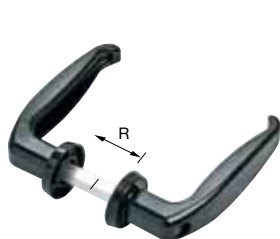

- Maniglia in alluminio
- Aluminium handle
- Béquille en aluminium
- Aluminium-Türdrücker

210

		R			
210-25-35	Ral 9005	25-35	20	3,5	3,035
210-25-35	argento/silver	25-35	20	3,5	4,040
210-40-50	Ral 9005	40-50	20	3,6	3,035
210-40-50	argento/silver	40-50	20	3,6	4,094
210-50-60	Ral 9005	50-60	20	3,7	3,035
210-50-60	argento/silver	50-60	20	3,7	4,094
210-60-70	Ral 9005	60-70	20	3,9	3,603
210-60-70	argento/silver	60-70	20	3,9	5,000

Categoria commerciale: 1H



- Maniglia in alluminio con grano
- Aluminium handle with dowel
- Béquille en aluminium avec grain
- Aluminium-Türdrücker mit Korn

211

		R			
211	Ral 9005	25-80	20	4,1	3,494
211	argento/silver	25-80	20	4,1	4,902

Categoria commerciale: 1H

NEW



- Maniglia per movimentare persiana/grate nera
- Black handle to move shutter/grate
- Poignée pour persiennes
- Griff für Fensterläden

212

212	Ral 9005	10	1,2	4,929

Categoria commerciale: 1M



- Maniglia in alluminio mod. "Valentina"
- Aluminium handle "Valentina"
- Béquille en aluminium "Valentina"
- Aluminium-Türdrücker Modell "Valentina"

213

213	Ral 9005	20	9,3	14,445

Categoria commerciale: 1H

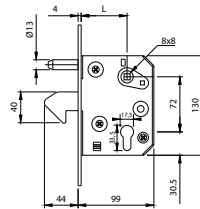

- Serratura a gancio con cilindro
- Hook-lock with cylinder
- Serrure à crochet avec cylindre
- Hackenschloss mit Schließzylinder

215

215-50	zinc	5	6,2	30,570
215-60	zinc	5	6,2	30,570

Categoria commerciale: 1N

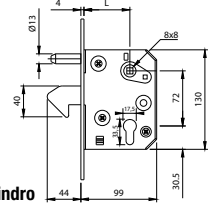

- Serratura a gancio senza cilindro
- Hook-lock without cylinder
- Serrure à crochet sans cylindre
- Hackenschloss ohne Schließzylinder

215-S

215S-50	zinc	5	5,3	27,448
215S-60	zinc	5	5,3	27,448

Categoria commerciale: 1N



- Contropiastra per serratura 215
- Counter-plate for lock 215
- Contre-platine pour serrare 215
- Gegenplatte für Schloss 215

216

216	zinc	25	3,5	1,015

Categoria commerciale: 1N



- Incontro per serratura a gancio con tappi ammortizzatori
- End with shock absorber cups for hook-lock
- Butée pour serrure à crochet avec bouchons amortisseurs
- Auflasschuh für Hackenschloss mit Schlüssdämpfern

217

217-40		4	2,20	21,257
217-50		4	2,60	24,260
217-60		4	4,00	33,136

Categoria commerciale: 1G



- Copri serratura
- Lock cover
- Couvre serrure
- Einbauschlosskasten

220

	A			€
220-40	21	20	11,7	9,095
220-50	11	20	11,7	9,095

Categoria commerciale: 1G



- Serratura a gancio frontale piatto con cilindro
- Plate face hook-lock with cylinder
- Serrure à crochet plat avec cylindre
- Hackenschloss flach mit Schließzylinder

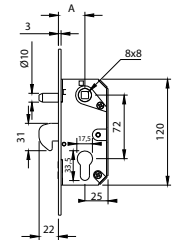

222

		A			€
222-30	zinc	30	5	3,2	38,628
222-35	zinc	35	5	3,6	40,320
222-40	zinc	40	5	3,7	41,052
222-45	zinc	45	5	3,8	47,919
222-50	zinc	50	5	3,6	48,203
222-60	zinc	60	5	4,1	51,413

Categoria commerciale: 1N



- Serratura a gancio frontale piatto senza cilindro
- Plate face hook-lock without cylinder
- Serrure à crochet plat sans cylindre
- Hackenschloss flach ohne Schließzylinder

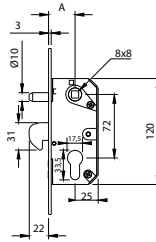

223

		A			€
223-30	zinc	30	5	2,5	31,204
223-35	zinc	35	5	2,6	31,651
223-40	zinc	40	5	2,4	36,248
223-45	zinc	45	5	2,5	38,759
223-50	zinc	50	5	2,6	39,993
223-60	zinc	60	5	2,8	41,488

Categoria commerciale: 1N



- Oliva in ottone
- Brass roller
- Rouleau en laiton
- Führungsrolle aus Messing

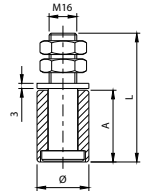

227

					€
227-30	Ø30	zinc	20	6,4	12,130
227-42	Ø42	zinc	20	13,8	19,718

Categoria commerciale: 1L

NEW



- Oliva in nylon nera
- Black nylon roller
- Rouleau en nylon noir
- Schwarze Nylon-Führungsrolle

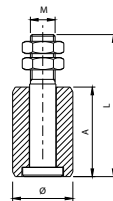

228

			M			€
228-30	Ø30	zinc	M16	20	3,7	4,62
228-40	Ø40	zinc	M16	20	5,2	6,00
228-50	Ø50	zinc	M16	20	5,22	12,70

Categoria commerciale: 1L



- Oliva in nylon
- Nylon roller
- Rouleau en nylon
- Nylon-Führungsrolle

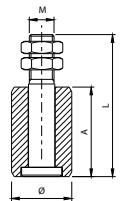

230

			M			€
230-25	Ø25	zinc	M14	20	2,4	3,035
230-30	Ø30	zinc	M16	20	3,7	3,341
230-40	Ø39	zinc	M16	20	5,2	3,941
230-41	Ø41	zinc	M16	20	4,4	4,247
230-42	Ø42	zinc	M16	20	5,5	4,553

Categoria commerciale: 1L



-Oliva in nylon
-Nylon roller
-Rouleau en nylon
-Nylon-Führungsrolle

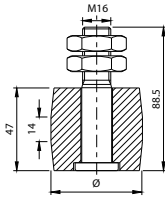

231

231-52	Ø52	zinc	20	5,7	6,038

Categoria commerciale: 1L



-Oliva in nylon con protezione antinfortunistica
-Nylon roller with accident prevention
-Rouleau en nylon pour la prévention des accidents
-Nylon-Führungsrolle für die Unfallverhütung

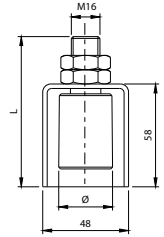

232

232-30	Ø30	zinc	20	4,2	3,668
232-40	Ø39	zinc	20	5,7	4,334

Categoria commerciale: 1L



-Oliva in nylon
-Nylon roller
-Rouleau en nylon
-Nylon-Führungsrolle

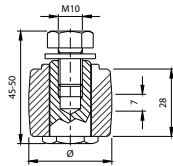

235

235-35	Ø34,5	zinc	20	2,0	3,887

Categoria commerciale: 1L



-Oliva in nylon
-Nylon roller
-Rouleau en nylon
-Nylon-Führungsrolle

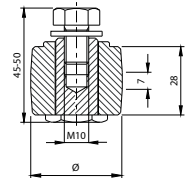

240

240-37,5	Ø37,5	zinc	20	2,2	3,887

Categoria commerciale: 1L



-Oliva conica in nylon
-Nylon conical roller
-Rouleau conique en nylon
-Nylon-Führungsrolle mit konischem Verlauf

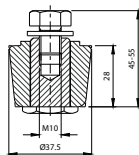

242

242-37,5	Ø37,5	zinc	20	2,3	4,487

Categoria commerciale: 1L



-Oliva a rullo in nylon
-Nylon roller
-Rouleau en nylon
-Nylon-Führungsrolle

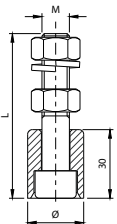

243

			M			
243-25	Ø25	zinc	M12	20	2,3	3,035
243-30	Ø30	zinc	M14	20	3,3	3,341
243-40	Ø40	zinc	M14	20	3,6	3,941

Categoria commerciale: 1L



-Perno con cuscinetto
-Pivot with bearing
-Pivot avec roulement
-Bolzen mit Kugellager

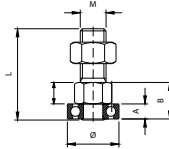

244

			M			€
244-25	Ø24	zinc	M12	20	1,3	7,129
244-30	Ø30	zinc	M14	20	2,1	8,647
244-40	Ø40	zinc	M14	20	3,2	10,307

Categoria commerciale: 1L



-Perno con cuscinetto
-Pivot with bearing
-Pivot avec roulement
-Bolzen mit Kugellager

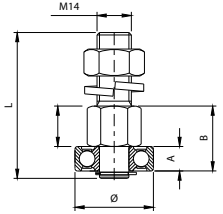

245

						€
245-32	Ø32	zinc		20	2,9	7,839
245-35	Ø35	zinc		20	3,3	9,510
245-42	Ø42	zinc		20	4,1	11,344

Categoria commerciale: 1L

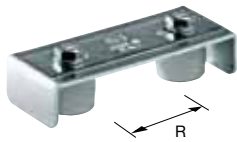

-Piastra mini guida cancello
-Small drive-gate plate
-Petite platine guide-portail
-Kleiner Führungsbügel

247

			R			€
247	Ø 34,5	zinc	30-60	20	9,5	15,165

Categoria commerciale: 1L

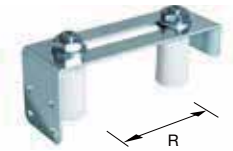

-Piastra mini guida cancello
-Small drive-gate plate
-Petite platine guide-portail
-Kleiner Führungsbügel

247 F

			R			€
247F	Ø 30	zinc	0-85	20	9,4	18,200

Categoria commerciale: 1L

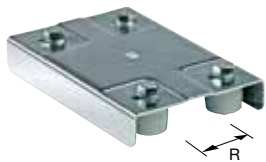

-Piastra guida cancello regolabile
-Drive-gate adjustable plate
-Platine guide-portail réglable
-Verstellbarer Torführungsbügel

250

			R			€
250-220	Ø 34,5	zinc	30-60	10	12,5	22,142

Categoria commerciale: 1L

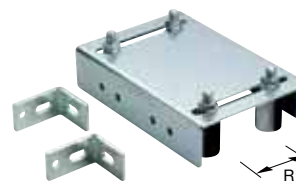

-Piastra guida cancello regolabile con staffe angolari
-Adjustable drive-gate plate with angle-brackets
-Platine guide-portail réglable avec plaques d'angle
-Verstellbarer Torführungsbügel mit Eckhalterungen

251

			R			€
251-220	Ø30	zinc	0-80	4	13,3	45,495
251-300	Ø40	zinc	0-120	2	7,5	54,590

Categoria commerciale: 1L

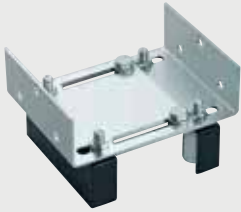

-Piastra doppia regolazione a fissare per cancelli con doppia colonna

- Double adjustment plate to be screwed for gates with 2 columns
- Platine double réglage à visser pour portails avec 2 colonnes
- Platte zum Anschrauben mit Doppelverstellung für Tore mit zwei Pfeiler

252

252-200	Ø40	zinc	0-300	1	4,1	51,555
Categoria commerciale: 1L						

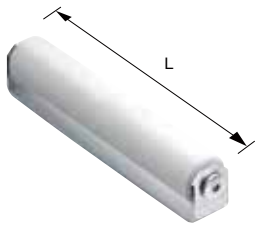
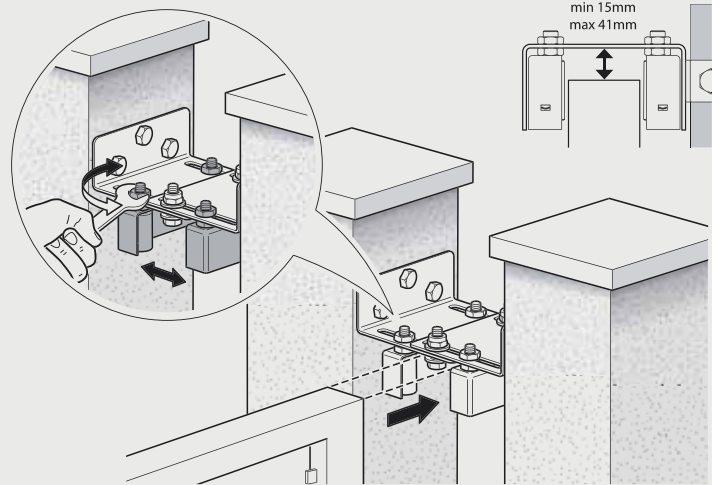

-Maxi rullo in nylon a fissare

- Big nylon-roller to be screwed
- Rouleau en nylon grand à visser
- Maxi-Walze aus Nylon zum Anschrauben

253

253-40	L	zinc	3	3,0		46,096
Categoria commerciale: 1L						

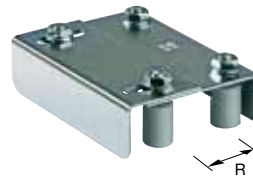

-Piastra guida cancello a doppia regolazione

- Guiding plate for gates with double adjustment
- Platine guide-portail à double réglage
- Torführungsbügel mit Doppelverstellung

255

255-220	Ø30	zinc	35-62	10	22,7	24,566
255-350	Ø40	zinc	62-85	5	27,9	36,390
Categoria commerciale: 1L						

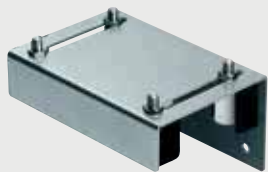

- Piastra guida cancello regolabile con ala lunga a fissare

- Adjustable guiding plate for gates with long wing to be screwed
- Platine guide-portail réglable avec aile longue à visser
- Verstellbarer Torführungsbügel mit langem Flügel zum Anschrauben

256

256-220	Ø30	zinc	0-80	4	12,6	39,425
256-300	Ø40	zinc	0-120	2	9,0	48,520
Categoria commerciale: 1L						

256-220 min 13mm max 34mm
256-300 min 13mm max 41mm

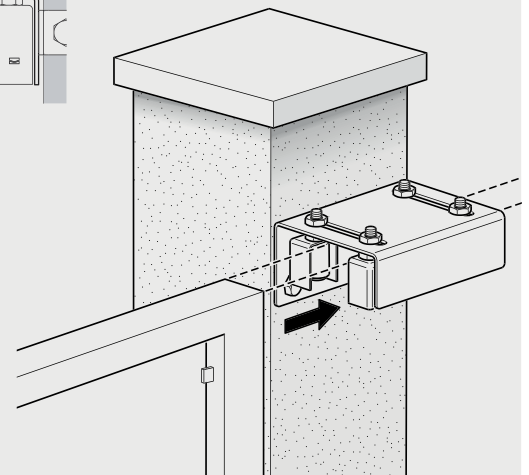
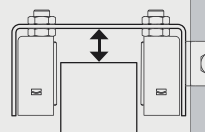



- Piastra guida cancello regolabile gigante
- Adjustable big plate for gates
- Platine guide-portail réglable géante
- Extra-grosser verstellbarer Torführungsbügel

257

			R			
257-300	zinc	0-117	4	15,8	65,202	
257-400	zinc	0-117	4	18,5	71,273	
257-500	zinc	0-117	4	22,0	74,308	
257-600	zinc	0-117	4	23,7	78,850	
257-700	zinc	0-117	4	26,9	84,920	
257-800	zinc	0-117	4	29,4	106,145	

Categoria commerciale: 1L

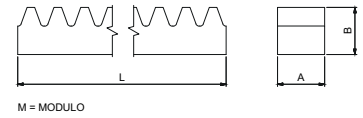

- Cremagliera quadra
- Square rack
- Crémaillère carrée
- Viereckige Zahnstange

260

			A	B	M			
260-22x22	L=1000	zinc	22	22	4	1	3,1	28,430
260-22x22	L=2000	zinc	22	22	4	1	6,2	56,588
260-30x30	L=1000	zinc	30	30	6	1	6,0	56,359
260-30x30	L=2000	zinc	30	30	6	1	12,00	129,269

Categoria commerciale: 1F

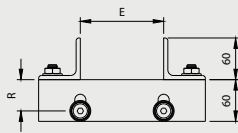

- Piastra guida cancello interna regolabile a fissare
- Adjustable internal guiding plate for gates to be screwed
- Platine guide-portail intérieur réglable à visser
- Verstellbarer Innenführungsbügel für Tore zum Anschrauben

258

		R			
258-30	zinc	30-45	6	14,4	33,365

Categoria commerciale: 1L

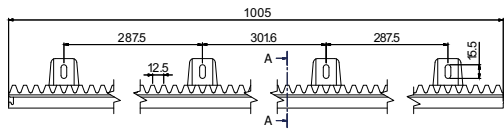
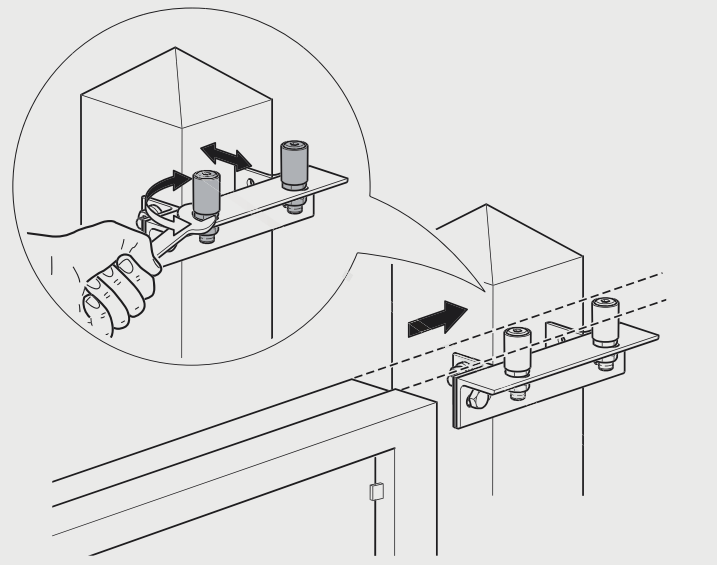

A-A (1:2)



- Cremagliera in nylon e corpo in acciaio
- Nylon-rack with steel body
- Crémaillère en nylon avec corps en acier
- Nylon-Zahnstange mit Stahlkörper

261

261-26x20	L=1000	1	0,9	12,698	

Categoria commerciale: 1F

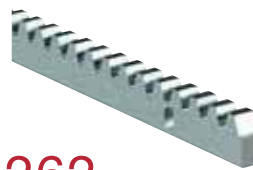

- Cremagliera Rettangolare 30x8 - 30x12 con fori
- Rectangular rack 30x8-30x12 with holes
- Crémaillère rectangulaire 30x8-30x12 avec trous
- Rechteckige Zahnstange 30x8-30x12 mit Bohrungen

262

		A				
262-30x8	L=1000	450,5	zinc	1	1,6	11,529
262-30x12	L=1000	450,5	zinc	1	2,4	12,741
262-30x12	L=2000	632	zinc	1	4,9	26,989

Categoria commerciale: 1F



- **Distanziale per cremagliera rettangolare**
- Fixing unit for rectangular rack
- Attache-entretoise pour crémaillère rectangulaire
- Distanzstück für rechteckige Zahnstange

263

263	zinc	30	2,0	1,812

Categoria commerciale: 1F



- **Attacco a saldare per cremagliera rettangolare**
- Support for rectangular rack to be welded
- Attache entretoise pour crémaillère rectangulaire
- Distanzstück für rechteckige Zahnstange zum Schweißen

264

264	zinc	30	1,5	1,670

Categoria commerciale: 1F

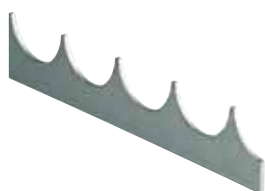

- **Cremagliera anti intrusione**
- Antitheft rack
- Crémaillère antivol
- Zackenleiste

265

265	L=2000	10	8,4	9,040
265	L=3000	10	13,4	11,704

Categoria commerciale: 1F



- **Attacco in zama per cremagliera rettangolare**
- Alloy support for rectangular rack
- Attache entretoise en zamak pour crémaillère rectangulaire
- Zamak-Distanzstück für rechteckige Zahnstange

266

266	zinc	30	2,1	2,882

Categoria commerciale: 1F



- **Maniglia ad incasso**
- Flush-mounted handle
- Poignée à encaisser
- Muschelgriff

270

270P	52x115	zinc	30	2,5
270G	90x200	zinc	30	7,3

Categoria commerciale: 1H



- **Maniglia ad incasso con leva**
- Flush-mounted handle with lever
- Poignée à encaisser avec levier
- Muschelgriff mit Triebriegel

272

272	90x200	zinc	30	11,4

Categoria commerciale: 1H

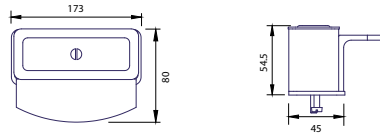

- Battente porta incontro a montaggio rapido regolabile
- Easy to set up adjustable batten
- Battant réglable à montage rapide
- Einfach zum Einstellen verstellbares Schließblech

275

275	40-50	zinc	4	2,8	18,135

Categoria commerciale: 1G

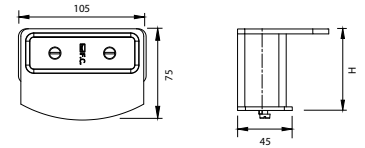

- Battente porta incontro
- Battent
- Battant
- Schließblech

275F

275F-30	zinc	37	4	2,2	11,224
275F-40	zinc	47	4	2,4	11,464
275F-50	zinc	57	4	2,8	11,704
275F-60	zinc	67	4	2,9	12,064

Categoria commerciale: 1G

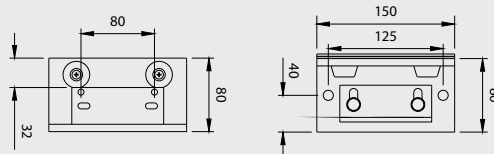

- Battente porta incontro regolabile a fissare con ammortizzatori
- Adjustable batten to be screwed with shock absorber cups
- Battant réglable à visser avec bouchons amortisseurs
- Verstellbares Schließblech zum Anschrauben mit Schlussdämpfern

276

276	50-70	zinc	4	7,3	81,263

Categoria commerciale: 1G

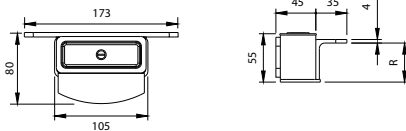
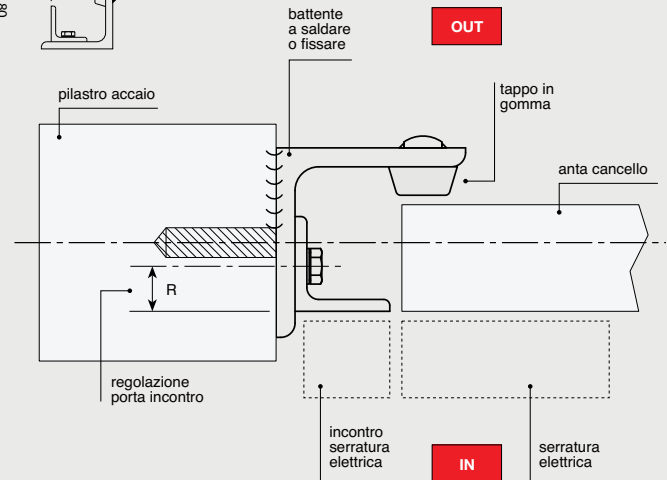

- Battente porta incontro regolabile a fissare
- Adjustable batten to be screwed
- Battant réglable à visser
- Verstellbares Schließblech zum Anschrauben

275PST

275PST	40-50	zinc	4	3,9	21,978

Categoria commerciale: 1G

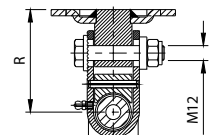

- Cardine "Giuliano"
- Hinge "Giuliano"
- Gond "Giuliano"
- Torband "Giuliano"

282

282-40x40	71-84	zinc	400 Kg	10	17,6

Categoria commerciale: 1A

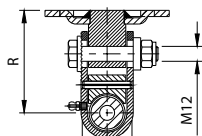

- Kit completo cardine "Giuliano"
- Kit for hinge "Giuliano"
- Kit complet gond "Giuliano"
- Satz Torband "Giuliano"

285

📄	R	📏	🗣️	🔒	€
285-30x30	71-81	zinc	2	6,1	72,790

Categoria commerciale: 1A



- Binario a cementare "Pendolino"
- Track to be cemented "Pendolino"
- Rail à sceller "Pendolino"
- Bodenlaufschiene zum Einbetonieren "Pendolino"

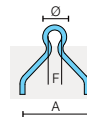

287

📄	📏	📏	A	F	🗣️	🔒	€
287P-Ø15-Sp3	L=3000	zinc	44	Ø9	10	75,0	58,248
287P-Ø15-Sp3	L=3000	zinc	44	Ø9	54	405,0	39,250
287P-Ø15-Sp3	L=6000	zinc	44	Ø9	10	150,0	68,958
287P-Ø15-Sp3	L=6000	zinc	44	Ø9	54	810,0	76,448
287-Ø17-Sp3	L=6000	zinc	53	Ø11	10	184,0	64,001
287-Ø17-Sp3	L=6000	zinc	53	Ø11	54	993,6	59,503
287G-Ø19-Sp3	L=3000	zinc	58	Ø13	10	93,3	38,551
287G-Ø19-Sp3	L=3000	zinc	58	Ø13	54	503,9	38,551
287G-Ø19-Sp3	L=6000	zinc	58	Ø13	10	186,6	64,034
287G-Ø19-Sp3	L=6000	zinc	58	Ø13	54	972,0	55,616
287G-Ø19-Sp4	L=3000	zinc	58	Ø13	10	123,0	54,448
287G-Ø19-Sp4	L=3000	zinc	58	Ø13	54	664,4	45,517
287G-Ø19-Sp4	L=6000	zinc	58	Ø13	10	226,0	76,885
287G-Ø19-Sp4	L=6000	zinc	58	Ø13	54	1188,0	71,830

Categoria commerciale: 1I



- Kit per 287G sp. 4mm filo pavimento
- Kit for art. 287G at floor level 4mm tick
- Kit pour art.287G au niveau du sol épaisseur 4mm
- Satz für art. 287G auf dem Fußbodenniveau 4mm stark

287FP

📄	📏	📏	🗣️	🗣️	🔒	€
287FP-G	L=3000	zinc	Ø19 / sp.4	1	11,0	82,548
287FP-G	L=6000	zinc	Ø19 / sp.4	1	21,7	159,654

Categoria commerciale: 1I



- Binario a fissare "Rapido"
- Track to be bolted "Rapido"
- Rail à visser "Rapido"
- Laufschiene zum Anschrauben "Rapido"

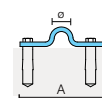

289

📄	📏	📏	A	Ø	🗣️	🔒	€
289P-Ø15-Sp3	L=3000	zinc	55	15	25	115,9	37,318
289P-Ø15-Sp3	L=6000	zinc	55	15	25	232,1	56,359
289G-Ø19-Sp3	L=3000	zinc	55	19	25	122,6	37,318
289G-Ø19-Sp3	L=6000	zinc	55	19	25	240,0	52,319

Categoria commerciale: 1I

NEW



- Binario a fissare "Rapido"
- Track to be bolted "Rapido"
- Rail à visser "Rapido"
- Laufschiene zum Anschrauben "Rapido"



289LG-19-sp3

📄	📏	📏	A	Ø	🗣️	🔒	€
289LG-19-sp3	L=3000	zinc	80	19	10	66,78	30,352

Categoria commerciale: 1I



- Spina di collegamento per binario Art. 289 - Ø15
- Connection pin for track Art. 289 - Ø15
- Jonction pour rail Art. 289 - Ø15
- Verbindungsstift zum Laufschiene Art. 289 - Ø15

290

📄	📏	📏	🗣️	🔒	€
290	90-Ø9	zinc	10	0,50	4,182

Categoria commerciale: 1I



- Binario a cementare "Espresso"
- Track to be cemented "Espresso"
- Rail à sceller "Espresso"
- Laufschiene zum Einbetonieren "Espresso"

292

Art.	L	Material	Sp	Weight	Price
292	L=3000	zinc	26	289,9	105,959
292	L=6000	zinc	26	579,8	195,072

Categoria commerciale: 1I

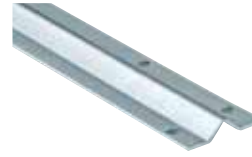

- Binario a fissare "Diretto"
- Track to be bolted "Diretto"
- Rail à visser "Diretto"
- Laufschiene zum Anschrauben "Diretto"

293

Art.	L	Material	Sp	Weight	Price
293	L=3000	zinc	25	112,5	41,849
293	L=6000	zinc	25	225,0	59,296

Categoria commerciale: 1I



- Spina di collegamento per binario Art. 289 - 019
- Connection pin for track Art. 289 - 019
- Jonction pour rail Art. 289 - 019
- Verbindungsstift zum Laufschiene Art. 289 - 019

291

Art.	Ø	Material	Sp	Weight	Price
291	80-Ø12	zinc	10	0,80	2,795

Categoria commerciale: 1I



- Spina di collegamento per binario Art. 292
- Connection pin for track Art. 292
- Jonction pour rail Art. 292
- Verbindungsstift zum Art. 292

294

Art.	Ø	Material	Sp	Weight	Price
294	90-Ø17	zinc	10	1,60	2,326

Categoria commerciale: 1I



- Spina di collegamento per binario Art. 293 - 287 015
- Connection pin for track Art. 293 - 287 015
- Jonction pour rail Art. 293 - 287 015
- Verbindungsstift zum Art. 293 - 287 015

295

Art.	Ø	Material	Sp	Weight	Price
295	90-Ø9,5	zinc	10	0,50	2,795

Categoria commerciale: 1I



- Spina di collegamento
- Connection pin
- Jonction pour rail
- Verbindungsstift

297

Art.	Ø	Material	Sp	Weight	Price	
297	90-Ø12,5	zinc	Sp=3-4mm	10	0,90	2,795

297: per binario Art. 287G sp 3-4mm - for Art.287G 3-4mm tick -
pour Art.287G ép. 3-4mm - zum Artikel 287G 3-4mm Stärke

Art.	Ø	Material	Sp	Weight	Price	
297G	90-Ø11,0	zinc	Sp=3mm	10	0,70	2,795

297G: per binario Art. 287 017 sp 3mm - for Art.287 017 3mm tick -
pour Art.287 017 ép. 3mm - zum Artikel 287 017 3mm Stärke

Categoria commerciale: 1I



- Ruota gola V
- Wheel with V groove
- Galet avec gorge V
- Schiebetorrolle mit V-Rille

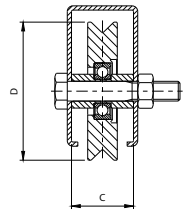

300 W

1 CUSCINETTO
1 BEARING

Art.	D	C	Material	Weight	Sp	Weight	Price
300V-40	Ø 40	16	zinc	50 Kg	50	5,3	7,282
300V-50	Ø 50	16	zinc	70 Kg	30	5,0	8,036
300V-60	Ø 60	24	zinc	100 Kg	12	3,6	8,647
300V-70	Ø 68	34	zinc	190 Kg	12	6,6	10,612
300V-80	Ø 78	34	zinc	200 Kg	10	7,1	11,529
300V-90	Ø 88	34	zinc	210 Kg	8	7,4	11,671
300V-100	Ø 98	34	zinc	220 Kg	8	9,3	11,824
300V-120	Ø 117	34	zinc	240 Kg	6	10,0	17,283
300V-140	Ø 137	44	zinc	270 Kg	2	5,3	22,742
300V-160	Ø 157	44	zinc	290 Kg	2	7,0	37,907
300V-200	Ø 197	44	zinc	330 Kg	2	11,2	50,037

Categoria commerciale: 1M



- Ruota gola U
- Wheel with U groove
- Galet avec gorge U
- Schiebetorrolle mit U-Rille

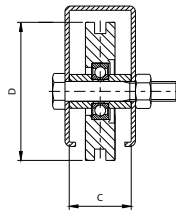

300 U

	D	C					€
300U-40	Ø 40	16	zinc	50 Kg	50	5,1	7,282
300U-50	Ø 50	16	zinc	70 Kg	30	4,8	8,036
300U-60	Ø 60	24	zinc	100 Kg	12	3,7	8,647
300U-70	Ø 68	34	zinc	190 Kg	12	6,5	10,612
300U-80	Ø 78	34	zinc	200 Kg	10	7,0	11,529
300U-90	Ø 88	34	zinc	210 Kg	8	7,4	11,671
300U-100	Ø 98	34	zinc	220 Kg	8	9,3	11,824
300U-120	Ø 117	34	zinc	240 Kg	6	10,0	17,283
300U-140	Ø 137	44	zinc	270 Kg	2	4,9	22,742
300U-160	Ø 157	44	zinc	290 Kg	2	6,6	37,907
300U-200	Ø 197	44	zinc	330 Kg	2	11,2	50,037

Categoria commerciale: 1M



- Ruota gola V
- Wheel with V groove
- Galet avec gorge V
- Schiebetorrolle mit V-Rille

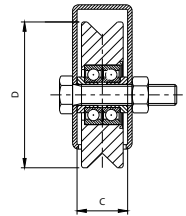

305 V

	D	C					€
305V-100	Ø98	34	zinc	425 Kg	8	11,7	19,718
305V-120	Ø117	34	zinc	450 Kg	6	12,6	23,659
305V-140	Ø137	44	zinc	550 Kg	2	6,6	33,365
305V-160	Ø157	44	zinc	575 Kg	2	9,2	44,884
305V-200	Ø197	44	zinc	625 Kg	2	14,8	65,202

Categoria commerciale: 1M



- Ruota gola U
- Wheel with U groove
- Galet avec gorge U
- Schiebetorrolle mit U-Rille

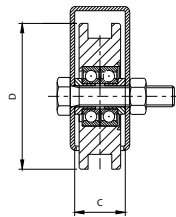

305 U

	D	C					€
305U-100	Ø98	34	zinc	425 Kg	8	10,7	19,718
305U-120	Ø117	34	zinc	450 Kg	6	12,8	23,659
305U-140	Ø137	44	zinc	550 Kg	2	6,6	33,365
305U-160	Ø157	44	zinc	575 Kg	2	8,5	44,884
305U-200	Ø197	44	zinc	625 Kg	2	14,0	65,202

Categoria commerciale: 1M



- Ruota gola Y con scarico
- Wheel with discharge Y groove
- Galet gorge Y avec décharge
- Schiebetorrolle mit Y-Rille

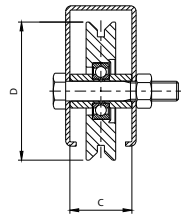

306 Y

	D	C					€
306Y-60	Ø 60	24	zinc	100 Kg	12	3,5	8,647
306Y-80	Ø 78	34	zinc	200 Kg	10	6,9	11,529
306Y-90	Ø 88	34	zinc	210 Kg	8	7,1	11,671
306Y-100	Ø 98	34	zinc	220 Kg	8	8,9	11,824
306Y-120	Ø 117	34	zinc	240 Kg	6	10,0	17,283
306Y-140	Ø 137	44	zinc	270 Kg	2	5,2	22,742
306Y-160	Ø 157	44	zinc	290 Kg	2	6,9	37,907
306Y-200	Ø 197	44	zinc	330 Kg	2	11,3	50,037

Categoria commerciale: 1M



- Ruota gola Y con scarico
- Wheel with discharge Y groove
- Galet gorge Y avec décharge
- Schiebetorrolle mit Y-Rille

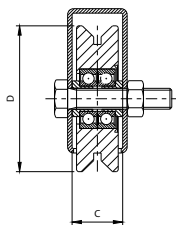

307 Y

	D	C					€
307Y-100	Ø 98	34	zinc	400 Kg	8	11,4	19,718
307Y-120	Ø 117	34	zinc	420 Kg	6	12,5	23,659
307Y-140	Ø 137	44	zinc	540 Kg	2	6,6	33,365
307Y-160	Ø 157	44	zinc	560 Kg	2	9,2	44,884
307Y-200	Ø 197	44	zinc	600 Kg	2	14,8	65,202

Categoria commerciale: 1M



- Ruota gola Y raccordata
- Wheel with Y-rounded groove
- Galet avec gorge Y arrondie
- Schiebetorrolle mit Y-Rille abgerundeter führung

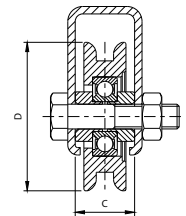

308 Y

	D	C					€
308-60	Ø 60	24	zinc	100 Kg	12	3,5	14,707
308-80	Ø 78	34	zinc	200 Kg	10	5,5	19,107

Categoria commerciale: 1M



- **Ruota gola semitonda**
- Wheel with half-rounded groove
- Galet avec gorge demi-ronde
- Schiebetorrolle mit Rundrille

310 W 1 CUSCINETTO
1 BEARING

										€
310-40	Ø 40	-	16	zinc	50 Kg	50	5,1			7,282
310-50	Ø 50	-	16	zinc	70 Kg	30	4,7			8,036
310-60	Ø 60	-	24	zinc	100 Kg	12	4,1			8,647
310-70	Ø 68	Ø15	34	zinc	190 Kg	12	5,8			10,612
310-80	Ø 78	Ø15	34	zinc	200 Kg	10	6,4			11,529
310-80S	Ø 78	Ø19	34	zinc	200 Kg	10	6,6			11,529
310-90	Ø 88	Ø15	34	zinc	210 Kg	8	6,9			11,671
310-90S	Ø 88	Ø19	34	zinc	210 Kg	8	6,9			11,671
310-100	Ø 98	Ø15	34	zinc	220 Kg	8	8,6			11,824
310-100S	Ø 98	Ø19	34	zinc	220 Kg	8	8,8			11,824
310-120	Ø 117	Ø19	34	zinc	240 Kg	6	10,4			17,283
310-140	Ø 137	Ø19	44	zinc	270 Kg	2	5,0			22,742
310-160	Ø 157	Ø19	44	zinc	290 Kg	2	6,6			37,907
310-200	Ø 197	Ø19	44	zinc	330 Kg	2	10,7			50,037

Categoria commerciale: 1M

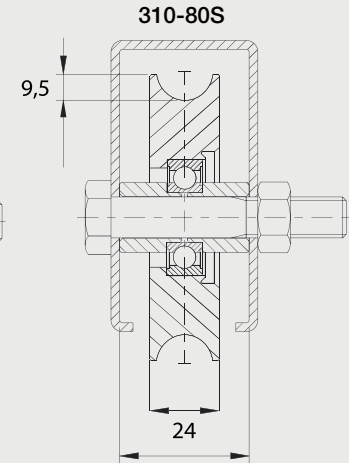
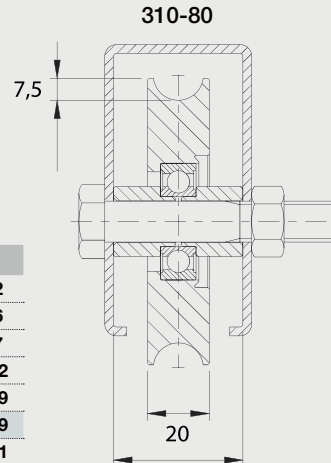

- **Ruota gola Y raccordata**
- Wheel with Y-rounded groove
- Galet avec gorge Y arrondie
- Schiebetorrolle mit Y-Rille abgerundeter führung

2 CUSCINETTI
2 BEARINGS

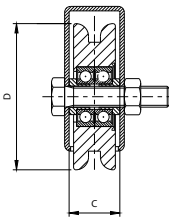

309 W

	D	C						€
309-80	Ø 78	34	zinc	380 Kg	10	8,1		19,107
309-100	Ø 98	34	zinc	400 Kg	8	11,4		22,742
309-120	Ø 117	34	zinc	420 Kg	6	11,5		33,365
309-140	Ø 137	44	zinc	540 Kg	2	6,3		40,943

Categoria commerciale: 1M



- **Ruota gola semitonda**
- Wheel with half-rounded groove
- Galet avec gorge demi-ronde
- Schiebetorrolle mit Rundrille

2 CUSCINETTI
2 BEARINGS

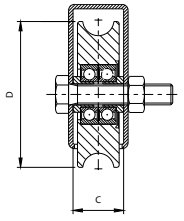

315 W

	D	C						€
315-100	Ø 19	Ø 98	34	zinc	425 Kg	8	10,8	19,718
315-120	Ø 19	Ø 117	34	zinc	450 Kg	6	11,9	23,659
315-140	Ø 19	Ø 137	44	zinc	550 Kg	2	6,2	33,365
315-160	Ø 19	Ø 157	44	zinc	575 Kg	2	8,9	44,884
315-200	Ø 19	Ø 197	44	zinc	625 Kg	2	14,4	65,202

Categoria commerciale: 1M



- **Ruota con ingrassatore gola V**
- Grease gun wheel with V groove
- Galet à graisseur gorge V
- Schiebetorrolle V-Rille mit Schmiernippel

1 CUSCINETTO
1 BEARING

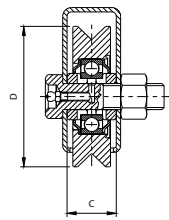

320 W

	D	C						€
320V-100	Ø 97	34	zinc	380 Kg	8	8,6		31,848
320V-120	Ø 117	44	zinc	400 Kg	6	13,3		39,425
320V-160	Ø 157	44	zinc	710 Kg	2	8,6		65,202
320V-200	Ø 197	44	zinc	750 Kg	2	13,8		87,955
320V-250	Ø 247	54	zinc	800 Kg	2	24,4		134,957

Categoria commerciale: 1M



- **Ruota con ingrassatore gola U**
- Grease gun wheel with U groove
- Galet à graisseur gorge U
- Schiebetorrolle U-Rille mit Schmiernippel

1 CUSCINETTO
1 BEARING

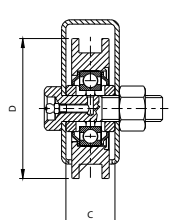

320 U

	D	C						€
320U-100	Ø 97	34	zinc	380 Kg	8	8,6		31,848
320U-120	Ø 117	44	zinc	400 Kg	6	11,6		39,425
320U-160	Ø 157	44	zinc	710 Kg	2	7,9		65,202
320U-200	Ø 197	44	zinc	750 Kg	2	13,8		87,955
320U-250	Ø 247	54	zinc	800 Kg	2	24,4		134,957

Categoria commerciale: 1M



- Ruota con supporto esterno gola V
- Wheel with external support , V groove
- Galet avec support extérieur, gorge V
- Schiebetrolle mit Außenstützplatte und V-Rille

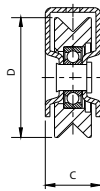

325 W

1 CUSCINETTO
1 BEARING

	D	C					€
325V-60	Ø 60	25	zinc	100 Kg	12	4,7	11,529
325V-80	Ø 78	36	zinc	200 Kg	6	5,8	15,165

Categoria commerciale: 1M



- Ruota con supporto esterno gola U
- Wheel with external support , U groove
- Galet avec support extérieur, gorge U
- Schiebetrolle mit Außenstützplatte und U-Rille

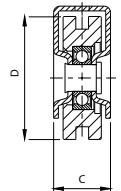

325 U

1 CUSCINETTO
1 BEARING

	D	C					€
325U-60	Ø 60	25	zinc	100 Kg	12	4,7	11,529
325U-80	Ø 78	36	zinc	200 Kg	6	5,8	15,165

Categoria commerciale: 1M



- Ruota con supporto esterno gola V
- Wheel with external support, V groove
- Galet avec support extérieur, gorge V
- Schiebetrolle mit Außenstützplatte und V-Rille

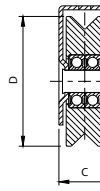

326 W

2 CUSCINETTI
2 BEARINGS

	D	C					€
326V-100	Ø 98	39	zinc	400 Kg	6	11,1	25,777

Categoria commerciale: 1M



- Ruota con supporto esterno gola U
- Wheel with external support, U groove
- Galet avec support extérieur, gorge U
- Schiebetrolle mit Außenstützplatte und U-Rille

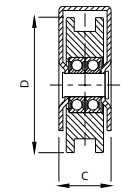

326 U

2 CUSCINETTI
2 BEARINGS

	D	C					€
326U-100	Ø 98	39	zinc	400 Kg	6	11,2	25,777

Categoria commerciale: 1M



- Ruota con supporto esterno gola semitonda
- Wheel with external support, half-rounded groove
- Galet avec support extérieur, gorge demi-ronde
- Schiebetrolle mit Außenstützplatte und Rundrille

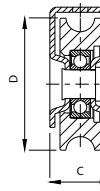

327 W

1 CUSCINETTO
1 BEARING

	D	C					€
327-60	Ø 60	25	zinc	100 Kg	12	5,1	11,529
327-80	Ø 78	36	zinc	200 Kg	6	5,6	15,165
327-80S	Ø 19 Ø 78	36	zinc	200 Kg	6	5,0	15,165

Categoria commerciale: 1M



- Ruota con supporto esterno gola semitonda
- Wheel with external support, half-rounded groove
- Galet avec support extérieur, gorge demi-ronde
- Schiebetrolle mit Außenstützplatte und Rundrille

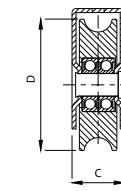

328 W

2 CUSCINETTI
2 BEARINGS

	D	C					€
328-100	Ø 19 Ø 98	39	zinc	400 Kg	6	10,5	25,777

Categoria commerciale: 1M



- Ruota con piastre gola V
- Wheel with external plates, V groove
- Galet avec platine extérieure, gorge V
- Schiebetorrolle mit Außenplatten und V-Rille

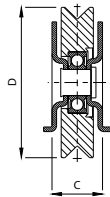

330 W

1 CUSCINETTO
1 BEARING

	D	C					€
330V-60	Ø 60	24	zinc	100 Kg	12	4,0	10,612
330V-70	Ø 68	29	zinc	170 Kg	6	3,4	12,741
330V-80	Ø 78	29	zinc	180 Kg	6	4,4	12,741
330V-90	Ø 88	32	zinc	190 Kg	6	6,0	14,554
330V-100	Ø 98	33	zinc	200 Kg	6	7,8	15,165
330V-120	Ø 117	33	zinc	220 Kg	2	4,3	18,495
330V-140	Ø 137	33	zinc	240 Kg	2	6,1	28,813

Categoria commerciale: 1M



- Ruota con piastre gola U
- Wheel with external plates, U groove Galet
- Gavec avec platine extérieure, gorge U
- Schiebetorrolle mit Außenstützplatte und U-Rille

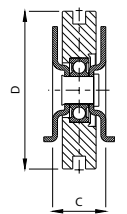

330 U

1 CUSCINETTO
1 BEARING

	D	C					€
330U-60	Ø 60	24	zinc	100 Kg	12	4,0	10,612
330U-70	Ø 68	29	zinc	170 Kg	6	3,4	12,741
330U-80	Ø 78	29	zinc	180 Kg	6	4,4	12,741
330U-90	Ø 88	32	zinc	190 Kg	6	6,5	14,554
330U-100	Ø 98	33	zinc	200 Kg	6	7,9	15,165
330U-120	Ø 117	33	zinc	220 Kg	2	3,9	18,495
330U-140	Ø 137	33	zinc	240 Kg	2	6,1	28,813

Categoria commerciale: 1M



- Ruota con piastre gola Y
- Wheel with external plates, Y groove
- Galet avec platine extérieure, gorge Y
- Schiebetorrolle mit Außenstützplatte und Y-Rille

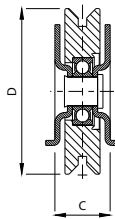

330 Y

1 CUSCINETTO
1 BEARING

	D	C					€
330Y-60	Ø 60	24	zinc	100 Kg	12	4,0	10,612
330Y-70	Ø 68	29	zinc	170 Kg	6	3,3	12,741
330Y-80	Ø 78	29	zinc	180 Kg	6	4,3	12,741
330Y-90	Ø 88	32	zinc	190 Kg	6	5,8	14,554
330Y-100	Ø 98	33	zinc	200 Kg	6	7,7	15,165
330Y-120	Ø 117	33	zinc	220 Kg	2	4,3	18,495
330Y-140	Ø 137	33	zinc	240 Kg	2	5,9	28,813

Categoria commerciale: 1M



- Ruota con piastre gola semitonda
- Wheel with external plates, half-rounded groove
- Galet avec platine extérieure, gorge demi-ronde
- Schiebetorrolle mit Außenstützplatte und Rundrille

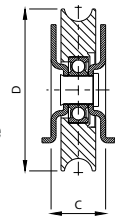

332 W

1 CUSCINETTO
1 BEARING

	D	C					€	
332-60	-	Ø 60	24	zinc	100 Kg	12	4,0	10,612
332-70	Ø15	Ø 68	29	zinc	170 Kg	6	3,3	12,741
332-80	Ø15	Ø 78	29	zinc	180 Kg	6	4,1	12,741
332-80S	Ø19	Ø 78	32	zinc	180 Kg	6	4,1	12,741
332-90	Ø15	Ø 88	32	zinc	190 Kg	6	5,7	14,554
332-90S	Ø19	Ø 88	32	zinc	190 Kg	6	5,7	14,554
332-100	Ø15	Ø 98	32	zinc	200 Kg	6	7,4	15,165
332-100S	Ø19	Ø 98	32	zinc	200 Kg	6	7,6	15,165
332-120	Ø19	Ø 117	33	zinc	220 Kg	2	4,0	18,495
332-140	Ø19	Ø 137	33	zinc	240 Kg	2	5,7	28,813

Categoria commerciale: 1M



- Ruota con piastre gola V
- Wheel with external plates, V groove
- Galet avec platine extérieure, gorge V
- Schiebetorrolle mit Außenstützplatte und V-Rille

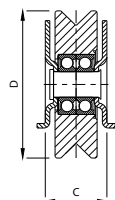

333 W

2 CUSCINETTI
2 BEARINGS

	D	C					€
333V-100	Ø 98	41	zinc	380 Kg	6	9,9	22,742
333V-120	Ø 117	41	zinc	400 Kg	2	4,9	31,236
333V-140	Ø 137	41	zinc	420 Kg	2	6,9	42,154

Categoria commerciale: 1M



- Ruota con piastre gola U
- Wheel with external plates, U groove
- Galet avec platine extérieure, gorge U
- Schiebetorrolle mit Außenstützplatte und U-Rille

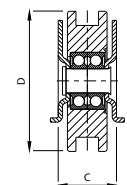

333 U

2 CUSCINETTI
2 BEARINGS

	D	C					€
333U-100	Ø 98	41	zinc	380 Kg	6	9,3	22,742
333U-120	Ø 117	41	zinc	400 Kg	2	4,6	31,236
333U-140	Ø 137	41	zinc	420 Kg	2	6,2	42,154

Categoria commerciale: 1M



- Ruota con piastre gola Y
- Wheel with external plates, Y groove
- Galet avec support extérieur, gorge Y
- Schiebetorrolle mit Außenstützplatte und Y-Rille

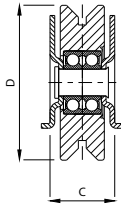

333 W

2 CUSCINETTI
2 BEARINGS

	D	C					€
333Y-100	Ø 98	41	zinc	380 Kg	6	9,7	22,742
333Y-120	Ø 117	41	zinc	400 Kg	2	4,8	31,236
333Y-140	Ø 137	41	zinc	420 Kg	2	6,8	42,154

Categoria commerciale: 1M



- Ruota con piastre gola semitonda
- Wheel with external plates, half-rounded groove
- Galet avec support extérieur, gorge demi-ronde
- Schiebetorrolle mit Außenstützplatte und Rundrille

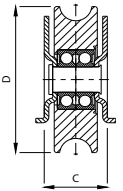

334 W

2 CUSCINETTI
2 BEARINGS

	D	C					€
334-100	Ø19 Ø 98	41	zinc	380 Kg	6	9,2	22,742
334-120	Ø19 Ø 117	41	zinc	400 Kg	2	4,6	31,236
334-140	Ø19 Ø 137	41	zinc	420 Kg	2	6,6	42,154

Categoria commerciale: 1M



- Ruota con supporto interno gola V
- Wheel with internal plate, V groove
- Galet avec platine interne, gorge V
- Schiebetorrolle mit Innenstützplatte und V-Rille

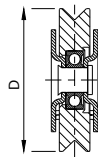

335 W

1 CUSCINETTO
1 BEARING

	D	C					€
335V-80	Ø78	32	zinc	180 Kg	6	4,8	12,741
335V-90	Ø88	32	zinc	190 Kg	6	6,6	13,953
335V-100	Ø98	32	zinc	200 Kg	6	8,1	15,766
335V-120	Ø117	37	zinc	220 Kg	2	4,5	20,624
335V-140	Ø137	40	zinc	240 Kg	2	6,1	25,472

Categoria commerciale: 1M



- Ruota con supporto interno gola U
- Wheel with external plates, U groove
- Galet avec platine interne, gorge U
- Schiebetorrolle mit Außenstützplatte und Rundrille

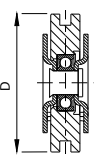

335 U

1 CUSCINETTO
1 BEARING

	D	C					€
335U-80	Ø78	32	zinc	180 Kg	6	4,8	12,741
335U-90	Ø88	32	zinc	190 Kg	6	6,7	13,953
335U-100	Ø98	32	zinc	200 Kg	6	8,0	15,766
335U-120	Ø117	37	zinc	220 Kg	2	4,1	20,624
335U-140	Ø137	40	zinc	240 Kg	2	5,8	25,472

Categoria commerciale: 1M



- Ruota con supporto interno gola Y
- Wheel with external plates, V groove
- Galet avec platine interne, gorge Y
- Schiebetorrolle mit Außenstützplatte und Rundrille

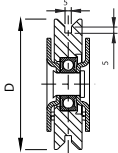
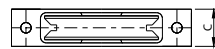

335 W

1 CUSCINETTO
1 BEARING

	D	C					€
335Y-80	Ø78	32	zinc	180 Kg	6	4,7	12,741
335Y-90	Ø88	32	zinc	190 Kg	6	6,5	13,953
335Y-100	Ø98	32	zinc	200 Kg	6	7,8	15,766
335Y-120	Ø117	37	zinc	220 Kg	2	4,3	20,624
335Y-140	Ø137	40	zinc	240 Kg	2	6,0	25,472

Categoria commerciale: 1M



- Ruota con supporto interno gola V
- Wheel with internal plate, V groove
- Galet avec platine interne, gorge V
- Schiebetorrolle mit Innenstützplatte und V-Rille

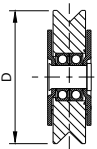

336 W

2 CUSCINETTI
2 BEARINGS

	D	C					€
336V-90	Ø88	32	zinc	300 Kg	6	7,6	18,200
336V-100	Ø98	32	zinc	380 Kg	6	9,2	19,718
336V-120	Ø117	37	zinc	400 Kg	2	5,0	25,777
336V-140	Ø137	40	zinc	420 Kg	2	7,0	37,907
336V-160	Ø157	42	zinc	640 Kg	2	10,6	48,520
336V-200	Ø197	42	zinc	700 Kg	2	16,8	84,920

Categoria commerciale: 1M



-Ruota con piastre gola U

- Wheel with external plates, U groove
- Galet avec platine extérieure, gorge U
- Schiebetorrolle mit Außenstützplatte und U-Rille

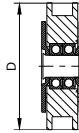

336 U

2 CUSCINETTI
2 BEARINGS

	D	C						€
336U-90	Ø88	32	zinc	300 Kg	6	6,8	18,200	
336U-100	Ø98	32	zinc	380 Kg	6	8,1	19,718	
336U-120	Ø117	37	zinc	400 Kg	2	4,5	25,777	
336U-140	Ø137	40	zinc	420 Kg	2	6,3	37,907	
336U-160	Ø157	42	zinc	640 Kg	2	9,8	48,520	
336U-200	Ø197	42	zinc	700 Kg	2	16,8	84,920	

Categoria commerciale: 1M



- Ruota con supporto interno gola Y

- Wheel with internal plate, Y groove
- Galet avec platine interne, gorge Y
- Schiebetorrolle mit innenstützplatte und Y-Rille

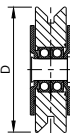

336 Y

2 CUSCINETTI
2 BEARINGS

	D	C						€
336Y-90	Ø88	32	zinc	300 Kg	6	7,2	18,200	
336Y-100	Ø98	32	zinc	380 Kg	6	8,7	19,718	
336Y-120	Ø117	37	zinc	400 Kg	2	4,9	25,777	
336Y-140	Ø137	40	zinc	420 Kg	2	6,9	37,907	
336Y-160	Ø157	42	zinc	640 Kg	2	10,5	48,520	
336Y-200	Ø197	42	zinc	700 Kg	2	16,7	84,920	

Categoria commerciale: 1M



- Ruota supporto interno gola semitonda

- Wheel with internal plate, half-rounded groove
- Galet avec platine interne, gorge demi-ronde
- Schiebetorrolle mit Rundrille und Innenstützplatte

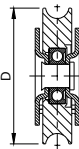

337 W

1 CUSCINETTO
1 BEARING

	D	C						€
337-80	Ø15	Ø78	32	zinc	180 Kg	6	4,4	12,741
337-80S	Ø19	Ø78	32	zinc	180 Kg	6	4,5	12,741
337-90	Ø15	Ø 88	32	zinc	190 Kg	6	6,3	13,953
337-90S	Ø19	Ø 88	32	zinc	190 Kg	6	6,4	13,953
337-100	Ø15	Ø 98	32	zinc	200 Kg	6	7,6	15,766
337-100S	Ø19	Ø 98	32	zinc	200 Kg	6	7,8	15,766
337-120	Ø19	Ø 117	37	zinc	220 Kg	2	4,2	20,624
337-120S	Ø19	Ø117	32	zinc	220 Kg	2	3,5	20,624
337-140	Ø19	Ø 137	40	zinc	240 Kg	2	5,8	25,472

Categoria commerciale: 1M



- Ruota supporto interno gola semitonda a 2 cuscinetti

- Wheel with internal plate, half-rounded groove and 2 bearings
- Galet avec platine interne, gorge demi-ronde et 2 roulements
- Schiebetorrolle mit Rundrille, Innenstützplatte und 2 Kugellagern

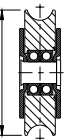

338 W

2 CUSCINETTI
2 BEARINGS

	D	C						€
338-90	Ø19	Ø88	32	zinc	300 Kg	6	7,2	18,200
338-100	Ø19	Ø98	32	zinc	380 Kg	6	8,7	19,718
338-120	Ø19	Ø117	37	zinc	400 Kg	2	4,7	25,777
338-140	Ø19	Ø137	40	zinc	420 Kg	2	6,7	37,907
338-160	Ø19	Ø157	42	zinc	640 Kg	2	10,1	48,520
338-200	Ø19	Ø197	42	zinc	700 Kg	2	16,3	84,920

Categoria commerciale: 1M



- Ruote combinate gola V con ingrassatore

- Grease gun twin wheels V groove
- Galets combinés avec graisseur, gorge V
- Verknüpfte Schiebetorrollen mit V-Rille und Schmiernippel

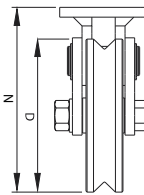

339 W

2 CUSCINETTI
2 BEARINGS

	D	N						€
339V-120	Ø117	170	Ø19	zinc	1200 Kg	2	20,1	169,840
339V-160	Ø157	190	Ø19	zinc	1920 Kg	2	30,5	197,135

Categoria commerciale: 1M



- Ruote combinate gola U con ingrassatore

- Grease gun twin wheels U groove
- Galets combinés avec graisseur, gorge U
- Verknüpfte Schiebetorrollen mit U-Rille und Schmiernippel

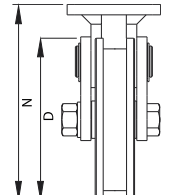

339 U

2 CUSCINETTI
2 BEARINGS

	D	N						€
339U-120	Ø117	170	Ø19	zinc	1200 Kg	2	20,1	169,840
339U-160	Ø157	190	Ø19	zinc	1920 Kg	2	29,9	197,135

Categoria commerciale: 1M



- Ruote combinate gola semitonda con ingrassatore**
 -Grease gun twin wheels half-rounded groove
 -Galets combinés avec graisseur, gorge demi-ronde
 -Verknüpfte Schiebetorrollen mit Rundrille und Schmiernippel

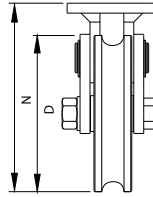

339 W



	D	N						€
339-120	Ø117	170	Ø19	zinc	1200 Kg	2	20,5	169,840
339-160	Ø157	190	Ø19	zinc	1920 Kg	2	30,4	197,135

Categoria commerciale: 1M



- Ruota per fune gola semitonda a 1 cuscinetto**
 - Wheel for rope, half-rounded groove and 1 bearing
 - Galet pour corde, gorge demi-ronde et 1 roulement
 - Rolle für seil, Rundrille und 1 Kugellager

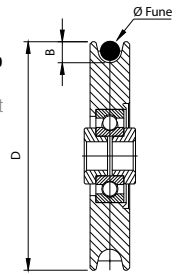

340 W



	D	B						€
340-60	Ø58	7	zinc	100 Kg	12	2,3		13,648
340-80	Ø78	9	zinc	200 Kg	12	4,7		16,683
340-100	Ø98	9	zinc	220 Kg	10	7,6		21,225
340-120	Ø117	9	zinc	240 Kg	8	9,2		23,659

Categoria commerciale: 1M



- Ruota per fune in nylon gola semitonda a 1 cuscinetto**
 - Nylon wheel for rope, half-rounded groove and 1 bearing
 - Galet pour corde en nylon, gorge demi-ronde et 1 roulement
 - Nylon-rolle für seil, Rundrille und 1 Kugellager

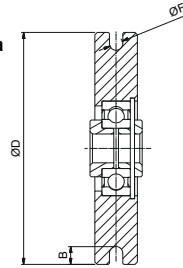

342 W



	D	B	F					€
342-80	Ø79	7	Ø6	50 Kg	12	1,8		19,107
342-90	Ø89	7	Ø6	60 Kg	10	1,8		20,013
342-100	Ø98	7,5	Ø5	70 Kg	10	1,9		22,142

Categoria commerciale: 1M



- Cuscinetto a sfere assiale tornito e cementato**
 - Turned ball bearing
 - Roulement à billes tourné et scellé
 - Axialkugellager

400

	D				€
400-9	Ø15	zinc	100	0,4	0,961
400-10	Ø17,5	zinc	100	0,6	0,994
400-11	Ø19	zinc	100	0,8	1,125
400-12	Ø20	zinc	100	0,9	1,125
400-14	Ø22	zinc	100	1,0	1,201
400-16,5	Ø27	zinc	100	1,5	1,256
400-20	Ø32	zinc	100	4,2	1,583

Categoria commerciale: 1E

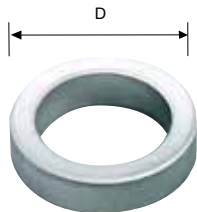

- Rondella in acciaio Zincato e Sinterizzato**
 - Galvanized and sintered steel washer
 - Rondelle en acier zingué et fritté
 - Gesinterter Stahlzwischenring

401S

	D				€
401S-12	Ø20	zinc	50	0,5	0,371
401S-14	Ø22	zinc	50	0,6	0,437
401S-20	Ø28	zinc	50	0,8	0,579

Categoria commerciale: 1E

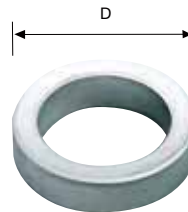

- Rondella in acciaio Zincato**
 - Galvanized and sintered steel washer
 - Rondelle en acier zingué
 - Gesinterter Stahlzwischenring

401Z

	D				€
401Z-6	Ø9	zinc	200	0,2	0,109
401Z-8	Ø12	zinc	200	0,2	0,120
401Z-9	Ø13	zinc	200	0,2	0,131
401Z-10	Ø15	zinc	200	0,4	0,142
401Z-11	Ø15	zinc	200	0,4	0,142
401Z-12	Ø18	zinc	200	0,6	0,153
401Z-14	Ø19	zinc	200	0,6	0,175

Categoria commerciale: 1E

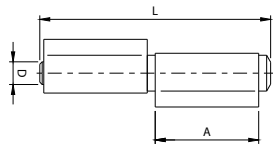

- Cerniera a 2 ali con perno sfilabile
- Hinge with 2 wings and extractable pivot
- Paumelle avec 2 ailes et pivot à déboîter
- Anschweißband 2-teilig mit lösem Zapfen

Perno Zincato
402

	L	A	D					€
402-60	58	26	Ø5,7	40	50 Kg*	40	1,5	0,513
402-80	83	38	Ø7,7	40	75 Kg*	50	4,0	0,600
402-100	104	48	Ø8,7	40	100 Kg*	50	5,7	0,732
402-120	122	57	Ø9,8	40	150 Kg*	40	7,2	0,884
402-140	144	68	Ø10,7	40	200 Kg*	40	9,4	1,059

* valore portata a coppia L/H=1 / capacity of couple hinges L/H=1

Categoria commerciale: 1E

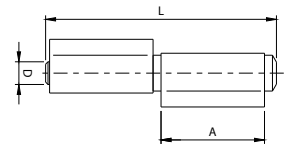

- Cerniera a 2 ali con perno sfilabile
- Hinge with 2 wings and extractable pivot
- Paumelle avec 2 ailes et pivot à déboîter
- Anschweißband 2-teilig mit lösem Zapfen

402Z

	L	A	D					€
402Z-60	58	26	Ø5,7	zinc	50 Kg*	40	1,6	0,666
402Z-80	83	38	Ø7,7	zinc	75 Kg*	50	4,0	0,808
402Z-100	104	48	Ø8,7	zinc	100 Kg*	50	5,7	0,939
402Z-120	122	57	Ø9,8	zinc	150 Kg*	40	7,2	1,190
402Z-140	144	68	Ø10,7	zinc	200 Kg*	40	9,4	1,376

* valore portata a coppia L/H=1 / capacity of couple hinges L/H=1

Categoria commerciale: 1E

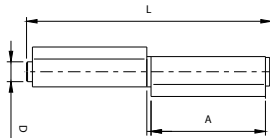

- Cerniera pesante a 2 ali con perno sfilabile
- Heavy hinge with 2 wings and extractable pivot
- Paumelle lourde avec 2 ailes et pivot à déboîter
- Anschweißband 2-teilig schwere Ausführung mit lösem Zapfen

Perno Zincato
405

	L	A	D					€
405-140	145	68	Ø11,7	250 Kg*	20	5,8	1,670	
405-170	174	83	Ø11,7	250 Kg*	20	7,0	1,791	
405-200	205	98	Ø13,6	350 Kg*	14	7,2	2,216	

* valore portata a coppia L/H=1 / capacity of couple hinges L/H=1

Categoria commerciale: 1E

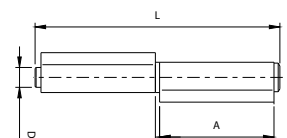

- Cerniera pesante a 2 ali con perno sfilabile
- Heavy hinge with 2 wings and extractable pivot
- Paumelle lourde avec 2 ailes et pivot à déboîter
- Anschweißband 2-teilig schwere Ausführung mit lösem Zapfen

405Z

	L	A	D					€
405Z-140	145	68	Ø11,7	zinc	250 Kg*	20	5,8	2,074
405Z-170	174	83	Ø11,7	zinc	250 Kg*	20	7,0	2,336
405Z-200	205	98	Ø13,6	zinc	350 Kg*	14	7,2	3,090

* valore portata a coppia L/H=1 / capacity of couple hinges L/H=1

Categoria commerciale: 1E

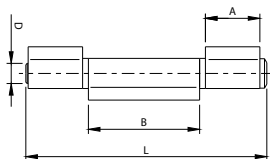

- Cerniera a 3 ali con perno sfilabile
- Hinge with 3 wings and extractable pivot
- Paumelle avec 3 ailes et pivot à déboîter
- Anschweißband 3-teilig mit lösem Zapfen

Perno Zincato
410

	L	A	B	D				€
410-80	83	18	38	Ø77	75 Kg*	50	3,9	0,884
410-100	104	23,5	48	Ø8,7	100 Kg*	50	5,7	1,004
410-120	122	27	57	Ø9,8	150 Kg*	40	7,2	1,212
410-140	144	33	68	Ø10,7	200 Kg*	40	9,5	1,299

* valore portata a coppia L/H=1 / capacity of couple hinges L/H=1

Categoria commerciale: 1E

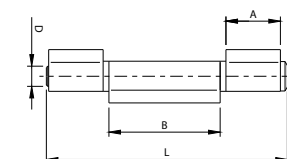

- Cerniera a 3 ali con perno sfilabile
- Hinge with 3 wings and extractable pivot
- Paumelle avec 3 ailes et pivot à déboîter
- Anschweißband 3-teilig mit lösem Zapfen

410Z

	L	A	B	D				€	
410Z-80	83	18	38	Ø77	zinc	75 Kg*	50	3,9	1,157
410Z-100	104	23,5	48	Ø8,7	zinc	100 Kg*	50	5,8	1,288
410Z-120	122	27	57	Ø9,8	zinc	150 Kg*	40	7,3	1,550
410Z-140	144	33	68	Ø10,7	zinc	200 Kg*	40	9,6	1,714

* valore portata a coppia L/H=1 / capacity of couple hinges L/H=1

Categoria commerciale: 1E

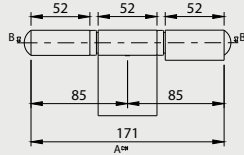

- Cerniera a 3 ali antiscasso con perno in acciaio inox e tappi in acciaio zincato
- Antitheft 3 wings hinge with s/s pivot and galvanized plugs
- Paumelle antivol à 3 ailes avec pivot en inox et bouchons zingué
- Einbruchssicheres Anschweißband 3-teilig mit Zapfen aus Edelstahl und Pfropfen Verzinkt

411 Tris

Perno INOX

📄	🔒	🗨️	👤	€
411-170	400 Kg*	10	7,0	20,111

* valore portata a coppia L/H=1 / capacity of couple hinges L/H=1

Categoria commerciale: 1E

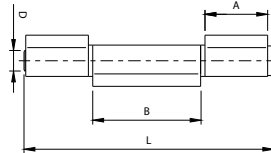
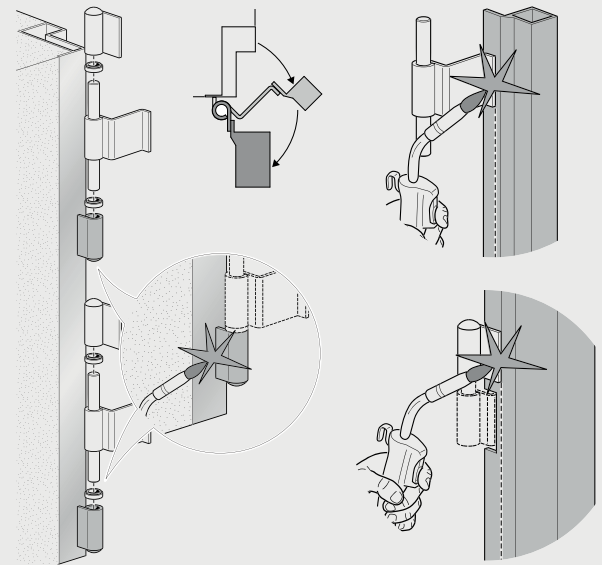

- Cerniera pesante a 3 ali con perno sfilabile
- Heavy hinge with 3 wings and extractable pivot
- Paumelle lourde avec 3 ailes et pivot à déboîter
- Anschweißband 3-teilig schwere Ausführung mit losem Zapfen

Perno Zincato

415

📄	L	A	B	D	🔒	🗨️	👤	€
415-140	145	36	62	Ø11,7	250 Kg*	20	5,9	1,791
415-170	174	44	75	Ø11,7	250 Kg*	20	7,0	2,020
415-200	205	52	89	Ø13,6	350 Kg*	16	8,2	2,577

* valore portata a coppia L/H=1 / capacity of couple hinges L/H=1

Categoria commerciale: 1E

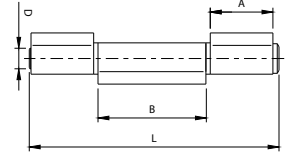

- Cerniera pesante a 3 ali con perno sfilabile
- Heavy hinge with 3 wings and extractable pivot
- Paumelle lourde avec 3 ailes et pivot à déboîter
- Anschweißband 3-teilig schwere Ausführung mit losem Zapfen

415Z

📄	L	A	B	D	🔒	🗨️	👤	€
415Z-140	145	36	62	Ø11,7	zinc 250 Kg*	20	9,9	2,326
415Z-170	174	44	75	Ø11,7	zinc 250 Kg*	20	7,0	2,391
415Z-200	205	52	89	Ø13,6	zinc 350 Kg*	16	8,2	3,068

* valore portata a coppia L/H=1 / capacity of couple hinges L/H=1

Categoria commerciale: 1E

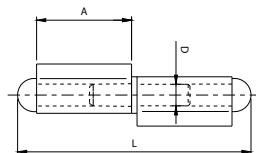

- Cerniera a 2 ali con tappo saldato
- Plug welded hinge with 2 wings
- Paumelle à 2 ailes avec bouchon soudé
- Anschweißband 2-teilig mit Anschweißpfropfen

420

📄	L	A	D	🔒	🗨️	👤	€	
420-60	64	26	Ø5,8	50 Kg*	40	1,3	1,015	
420-60	🔒	zinc	64	26	Ø5,8	50 Kg*	40	1,168
420-80	89,5	38	Ø7,8	75 Kg*	50	3,2	1,081	
420-80	🔒	zinc	89,5	38	Ø7,8	75 Kg*	50	1,243
420-100	110	48	Ø8,7	100 Kg*	50	4,4	1,168	
420-100	🔒	zinc	110	48	Ø8,7	100 Kg*	50	1,343
420-120	130	57	Ø9,8	150 Kg*	50	7,0	1,376	
420-120	🔒	zinc	130	57	Ø9,8	150 Kg*	50	1,582
420-140	152	68	Ø10,8	200 Kg*	50	9,0	1,430	
420-140	🔒	zinc	152	68	Ø10,8	200 Kg*	50	1,645

* valore portata a coppia L/H=1 / capacity of couple hinges L/H=1

Categoria commerciale: 1E

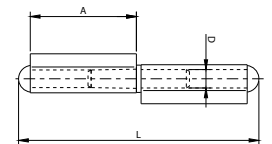

- Cerniera pesante a 2 ali con tappo saldato
- Heavy plug welded hinge with 2 wings
- Paumelle lourde à 2 ailes avec bouchon soudé
- Anschweißband 2-teilig schwere Ausführung mit Pfropfen

425

📄	L	A	D	🔒	🗨️	👤	€	
425-140	154	68	Ø11,8	250 Kg*	20	4,5	2,216	
425-140	🔒	zinc	154	68	Ø11,8	250 Kg*	20	2,549
425-170	184,5	83	Ø11,8	250 Kg*	20	5,2	2,216	
425-170	🔒	zinc	184,5	83	Ø11,8	250 Kg*	20	2,549
425-200	217,5	98	Ø13,8	350 Kg*	20	7,8	2,740	

* valore portata a coppia L/H=1 / capacity of couple hinges L/H=1

Categoria commerciale: 1E

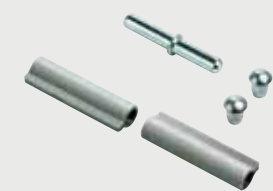

- Cerniera 2 ali pesante smontata perno e tappi zincati

- Heavy hinge with 2 wings and disassembled galvanised pivot and plugs
- Paumelle lourde à 2 ailes avec pivot et bouchons zingués et démontés
- Anschweißband 2-teilig schwere Ausführung mit verzinkter ausgebauter Zapfen und Pfropfen

425PS

	L	A	D				€
NEW 425PS-120	139	62	Ø11,9	250 Kg*	50	13,1	1,896
425PS-140	154	68	Ø11,9	250 Kg*	50	13,5	2,13
425PS-170	184,5	83	Ø11,9	250 Kg*	50	13,5	2,249

* valore portata a coppia L/H=1 / capacity of couple hinges L/H=1

Categoria commerciale: 1E

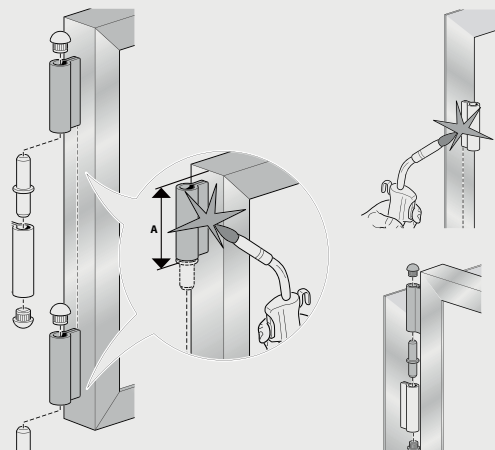

- Cerniera a 2 ali lunghe con tappo saldato

- Plug welded hinge with 2 long wings
- Paumelle à bouchon soudé avec 2 ailes longues
- Anschweißband 2-teilig mit Anschweißpfropfen

430DX

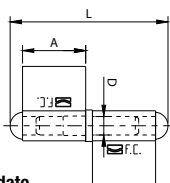

- Cerniera a 2 ali lunghe con tappo saldato

- Plug welded hinge with 2 long wings
- Paumelle à bouchon soudé avec 2 ailes longues
- Anschweißband 2-teilig mit Anschweißpfropfen

430SX

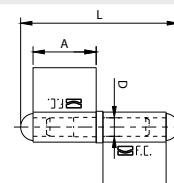

	L	A	D				€	
430DX-60	70	28	Ø8,3	100 Kg*	20	3,3	1,256	
430DX-60	zinc	70	28	Ø8,3	100 Kg*	20	3,3	1,444
430DX-80	92	38	Ø9	100 Kg*	20	3,1	1,529	
430DX-80	zinc	92	38	Ø9	100 Kg*	20	3,1	1,757
430DX-100	112	48	Ø9,8	150 Kg*	20	4,0	2,064	
430DX-100	zinc	112	48	Ø9,8	150 Kg*	20	4,0	2,373
430DX-120	132	57	Ø11,3	250 Kg*	20	5,3	2,249	
430DX-120	zinc	132	57	Ø11,3	250 Kg*	20	5,3	2,586
430DX-140	156	67	Ø11,8	250 Kg*	10	4,0	2,839	
430DX-140	zinc	156	67	Ø11,8	250 Kg*	10	4,0	3,265
430DX-170	190	84	Ø13	300 Kg*	10	6,2	3,483	
430DX-170	zinc	190	84	Ø13	300 Kg*	10	6,2	4,006
430DX-200	216	97	Ø13,9	350 Kg*	10	8,4	4,586	

* valore portata a coppia L/H=1 / capacity of couple hinges L/H=1

Categoria commerciale: 1E

	L	A	D				€	
430SX-60	70	28	Ø8,3	100 Kg*	20	3,3	1,256	
430SX-60	zinc	70	28	Ø8,3	100 Kg*	20	3,3	1,444
430SX-80	92	38	Ø9	100 Kg*	20	3,1	1,529	
430SX-80	zinc	92	38	Ø9	100 Kg*	20	3,1	1,757
430SX-100	112	48	Ø9,8	150 Kg*	20	4,0	2,064	
430SX-100	zinc	112	48	Ø9,8	150 Kg*	20	4,0	2,373
430SX-120	132	57	Ø11,3	250 Kg*	20	5,3	2,249	
430SX-120	zinc	132	57	Ø11,3	250 Kg*	20	5,3	2,586
430SX-140	156	67	Ø11,8	250 Kg*	10	4,0	2,839	
430SX-140	zinc	156	67	Ø11,8	250 Kg*	10	4,0	3,265
430SX-170	190	84	Ø13	300 Kg*	10	6,2	3,483	
430SX-170	zinc	190	84	Ø13	300 Kg*	10	6,2	4,006
430SX-200	216	97	Ø13,9	350 Kg*	10	8,4	4,586	

* valore portata a coppia L/H=1 / capacity of couple hinges L/H=1

Categoria commerciale: 1E



- Cerniera 2 ali piana con perno sfilabile

- Flat hinge with 2 wings and extractable pivot
- Paumelle plate à 2 ailes avec pivot à déboîter
- Flachband 2-teilig mit losem Zapfen

431

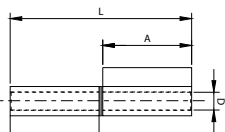

Perno Zincato

440

- Cerniera a 2 ali aperte perno sfilabile con rondella

- Big hinge 2 open wings extractable pivot with washer
- Paumelle grande 2 ailes ouvertes pivot à déboîter avec rondelle
- Winkelband mit 2 offenen Flügeln schwere Ausführung loser Zapfen mit Unterlegscheibe

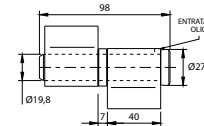

	L	A	D				€
431-80	82	40	Ø8	100 Kg*	50	4,6	1,277
431-80-Sp3	78	38	Ø8	100 Kg*	50	6,2	1,365
431-100	98	48	Ø10	150 Kg*	50	9,2	1,867
431-110	107	52	Ø10	150 Kg*	40	10,8	1,922
431-120	119	58	Ø12	250 Kg*	30	10,9	2,457

* valore portata a coppia L/H=1 / capacity of couple hinges L/H=1

Categoria commerciale: 1E

					€
440-90	800 Kg*	10	5,4		5,295

* valore portata a coppia L/H=1 / capacity of couple hinges L/H=1

Categoria commerciale: 1E

NEW

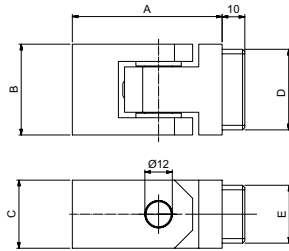

435

- Cerniera laterale per inferriate di sicurezza a doppio snodo
- Heavy duty side hinges for security grilles
- Paumelle latérale pour les balustrades double jonction
- Seitlicher Anschweißband für Sicherheitsgeländer mit Doppelgelenk

	A	B	C	D	E	🔒	🗨️	🔒	€
435-30x30	66	30	30	25.5	25.5	250	4	1.8	25,852
435-40x30	66	40	30	35.5	25.5	250	4	2.5	25,852

* valore portata a coppia L/H=1 / capacity of couple hinges L/H=1

Categoria commerciale: 1E

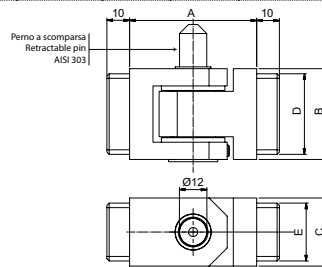

436

- Cerniera centrale per inferriate di sicurezza a doppio snodo con perno di chiusura
- Heavy duty centre hinges with pin for security grilles with double junction
- Paumelle centrale pour les balustrades double jonction avec pivot
- Seitlicher Anschweißband für Sicherheitsgeländer mit Doppelgelenk mit Zapfen

	A	B	C	D	E	🔒	🗨️	🔒	€
436-30x30	56	30	30	25.5	25.5	250	4	1.9	42,599
436-40x30	56	40	30	35.5	25.5	250	4	2.6	42,599

* valore portata a coppia L/H=1 / capacity of couple hinges L/H=1

Categoria commerciale: 1E

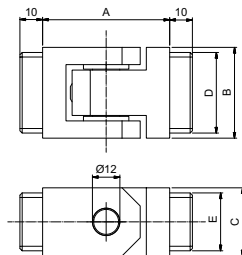

437

- Cerniera centrale per inferriate di sicurezza a doppio snodo
- Heavy duty centre hinges for security grilles with double junction
- Paumelle centrale pour les balustrades double jonction
- Seitlicher Anschweißband für Sicherheitsgeländer mit Doppelgelenk

	A	B	C	D	E	🔒	🗨️	🔒	€
437-30x30	56	30	30	25.5	25.5	250	4	1.7	25,852
437-40x30	56	40	30	35.5	25.5	250	4	2.4	25,852

* valore portata a coppia L/H=1 / capacity of couple hinges L/H=1

Categoria commerciale: 1E

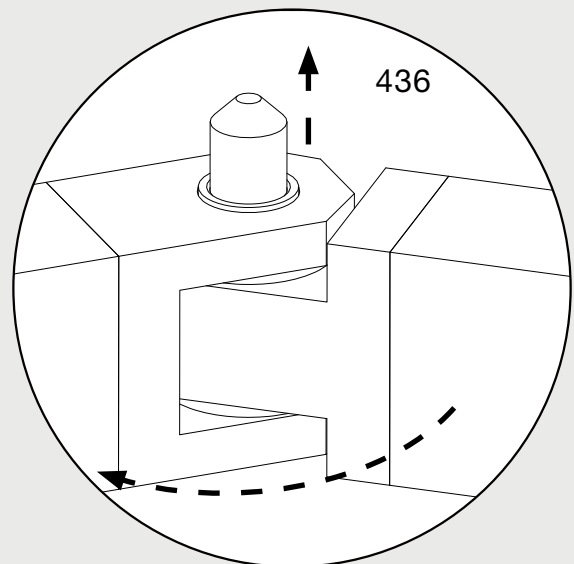
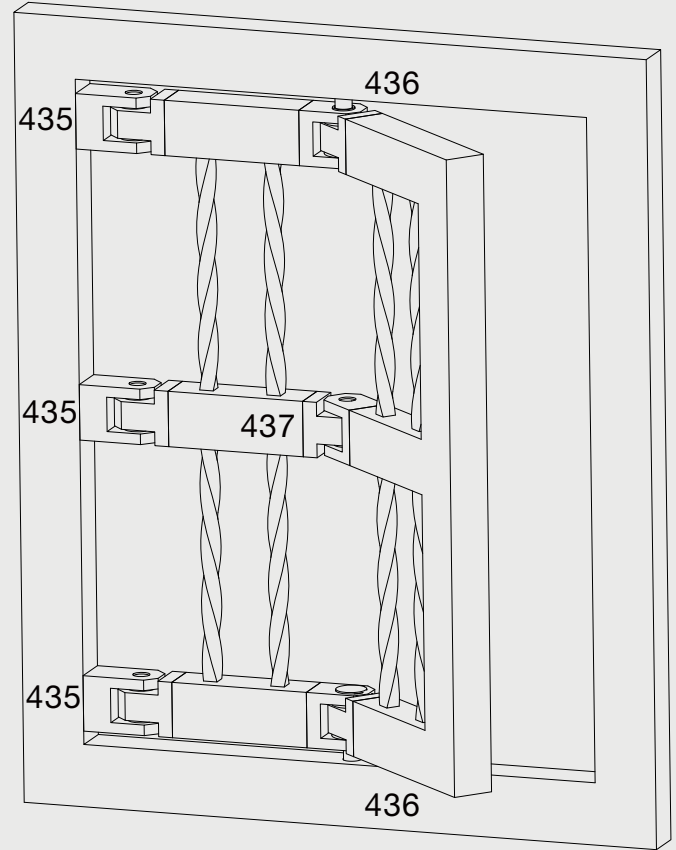

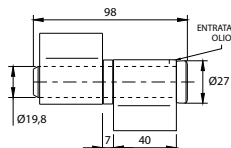

- Cernierona a 2 ali aperte perno sfilabile con cuscinetto
- Big hinge 2 open wings extractable pivot with bearing
- Paumelle grande 2 ailes ouvertes avec pivot à déboîter et roulement
- Winkelband 2-teilig schwere Ausführung loser Zapfen mit Kugellager

Perno Zincato
445

445-90	800 Kg*	10	5,4	6,671

* valore portata a coppia L/H=1 / capacity of couple hinges L/H=1

Categoria commerciale: 1E

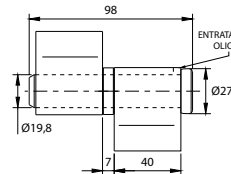

- Cernierona a 2 ali chiuse perno sfilabile con rondella e cuscinetto
- Big hinge 2 closed wings extractable pivot with washer and bearing
- Paumelle grande 2 ailes fermées pivot à déboîter avec rondelle et roulement
- Winkelband mit 2 geschlossenen Flügeln schwere Ausführung loser Zapfen mit Unterlegscheibe und Kugellager

Perno Zincato
450

450-90	400 Kg*	10	5,8	6,671

* valore portata a coppia L/H=1 / capacity of couple hinges L/H=1

Categoria commerciale: 1E

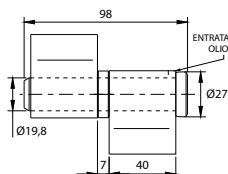

- Cernierona a 2 ali chiuse perno sfilabile con cuscinetto
- Big hinge 2 closed wings extractable pivot with bearing
- Paumelle grande 2 ailes fermées avec pivot à déboîter et roulement
- Flachband 2-teilig schwere Ausführung mit losem Zapfen und Kugellager

Perno Zincato
455

455-90	400 Kg*	10	5,4	6,977

* valore portata a coppia L/H=1 / capacity of couple hinges L/H=1

Categoria commerciale: 1E

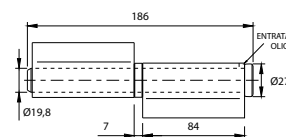

- Cernierona a 2 ali lunghe aperte perno sfilabile con rondella
- Big hinge 2 open wings extractable pivot with washer
- Paumelle grande 2 ailes ouvertes avec pivot à déboîter et rondelle
- Winkelband 2-teilig schwere Ausführung mit losem Zapfen und Unterlegscheibe

456

456-180	800 Kg*	4	4,2	7,850

* valore portata a coppia L/H=1 / capacity of couple hinges L/H=1

Categoria commerciale: 1E

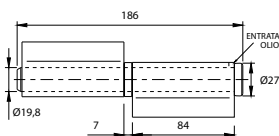

- Cernierona a 2 ali aperte perno sfilabile con cuscinetto
- Big hinge 2 open wings extractable pivot with bearing
- Paumelle grande 2 ailes ouvertes avec pivot à déboîter et roulement
- Winkelband 2-teilig schwere Ausführung mit losem Zapfen und Unterlegscheibe

Perno Zincato
457

457-180	800 Kg*	4	4,2	9,761

* valore portata a coppia L/H=1 / capacity of couple hinges L/H=1

Categoria commerciale: 1E

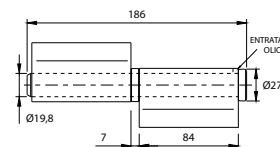

- Cernierona a 2 ali lunghe chiuse perno sfilabile con rondella
- Big hinge 2 closed wings extractable pivot with washer
- Paumelle grande 2 ailes fermées avec pivot à déboîter et rondelle
- Flachband 2-teilig schwere Ausführung mit losem Zapfen und Unterlegscheibe

458

458-180	800 Kg*	4	4,2	7,850

* valore portata a coppia L/H=1 / capacity of couple hinges L/H=1

Categoria commerciale: 1E

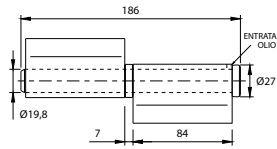

- **Cernierona a 2 ali lunghe chiuse perno sfilabile con cuscinetto**
- Big hinge 2 long closed wings extractable pivot with bearing
- Paumelle grande 2 ailes grandes et fermées, pivot à déboiter avec roulement
- Winkelband mit 2 langen geschlossenen Flügeln schwere Ausführung mit losem Zapfen, Kugellager

Perno Zincato

459

459-180	800 Kg*	4	4,3	9,761

* valore portata a coppia L/H=1 / capacity of couple hinges L/H=1

Categoria commerciale: 1E

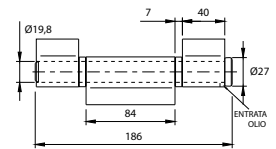

- **Cernierona a 3 ali aperte perno sfilabile con rondelle**
- Big hinge 3 open wings with washer
- Paumelle grande 3 ailes ouvertes pivot à déboiter avec rondelle
- Winkelband 3-teilig schwere Ausführung mit Unterlegscheiben

Perno Zincato

460

460-180	800 Kg*	4	4,2	8,800

* valore portata a coppia L/H=1 / capacity of couple hinges L/H=1

Categoria commerciale: 1E

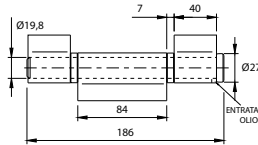

- **Cernierona a 3 ali aperte perno sfilabile con cuscinetto**
- Big hinge 3 open wings extractable pivot with bearing
- Paumelle grande 3 ailes ouvertes pivot à déboiter avec roulement
- Winkelband mit 3 offenen Flügeln schwere Ausführung mit losem Zapfen, Kugellager

Perno Zincato

465

465-180	800 Kg*	4	4,3	13,254

* valore portata a coppia L/H=1 / capacity of couple hinges L/H=1

Categoria commerciale: 1E

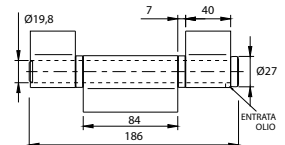

- **Cernierona a 3 ali chiuse perno sfilabile con rondella**
- Big hinge 3 closed wings extractable pivot with washer
- Paumelle grande 3 ailes fermées avec pivot à déboiter et rondelle
- Flachband 3-teilig schwere Ausführung mit losem Zapfen und Unterlegscheibe

Perno Zincato

470

470-180	800 Kg*	4	4,2	8,800

* valore portata a coppia L/H=1 / capacity of couple hinges L/H=1

Categoria commerciale: 1E

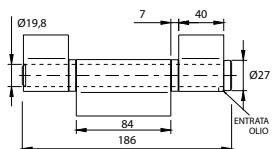

- **Cernierona a 3 ali chiuse perno sfilabile con cuscinetto**
- Big hinge 3 closed wings extractable pivot and bearing
- Paumelle grande 3 ailes fermées pivot à déboiter avec roulement
- Winkelband mit 3 geschlossenen Flügeln schwere Ausführung mit losem Zapfen, Kugellager

Perno Zincato

475

475-180	800 Kg*	4	4,2	13,254

* valore portata a coppia L/H=1 / capacity of couple hinges L/H=1

Categoria commerciale: 1E

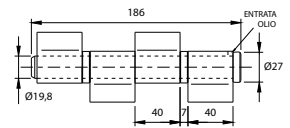
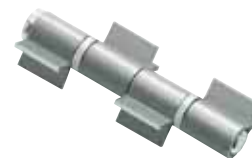

- **Cernierona a 4 ali aperte perno sfilabile con rondella**
- Big hinge 4 open wings extractable pivot with washer
- Paumelle grande 4 ailes ouvertes avec pivot à déboiter et rondelle
- Winkelband 4-teilig schwere Ausführung mit losem Zapfen und Unterlegscheibe

Perno Zincato

480

480-180	800 Kg*	4	4,1	9,073

* valore portata a coppia L/H=1 / capacity of couple hinges L/H=1

Categoria commerciale: 1E

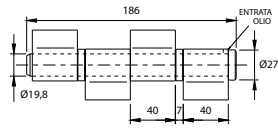
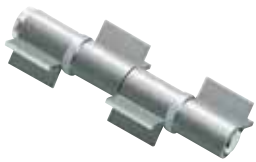

- Cerniera a 4 ali chiuse perno sfilabile con cuscinetto
- Big hinge 4 closed wings extractable pivot with bearing
- Paumelle grande 4 ailes fermées pivot à déboiter avec roulement
- Winkelband mit 4 geschlossenen Flügeln schwere Ausführung mit losem Zapfen, Kugellager

Perno Zincato

482

482-180	800 Kg*	4	4,2	13,789

* valore portata a coppia L/H=1 / capacity of couple hinges L/H=1

Categoria commerciale: 1E

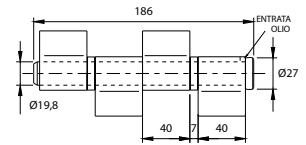

- Cerniera a 4 ali chiuse perno sfilabile con rondelle
- Big hinge 4 closed wings extractable pivot with washers
- Paumelle grande 4 ailes fermées avec pivot à déboiter et rondelles
- Flachband 4-teilig schwere Ausführung mit losem Zapfen und Unterlegscheiben

Perno Zincato

485

485-180	800 Kg*	4	4,1	9,073

* valore portata a coppia L/H=1 / capacity of couple hinges L/H=1

Categoria commerciale: 1E

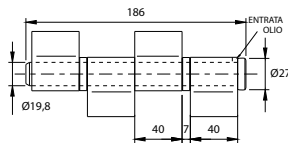

- Cerniera a 4 ali chiuse perno sfilabile con cuscinetto
- Big hinge 4 closed wings extractable pivot with bearing
- Paumelle grande 4 ailes fermées pivot à déboiter avec roulement
- Winkelband mit 4 geschlossenen Flügeln schwere Ausführung mit losem Zapfen und Kugellager

Perno Zincato

487

487-180	800 Kg*	4	4,2	13,789

* valore portata a coppia L/H=1 / capacity of couple hinges L/H=1

Categoria commerciale: 1E

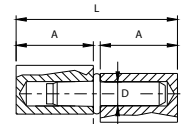

- Cerniera a goccia con perno in acciaio
- Drop hinge with steel pivot
- Paumelle à goutte avec pivot en acier
- Bandrolle mit Zapfen aus Stahl

490

	L	A	D				
490T-100	98	48	Ø8	150 Kg	40	4,3	2,020
490T-120	118	58	Ø9	200 Kg*	40	6,6	2,424
490-120	118	58	Ø9	200 Kg*	40	6,6	1,943
490-140	139	68	Ø9	300 Kg*	40	8,0	2,216

* valore portata a coppia L/H=1 / capacity of couple hinges L/H=1

Categoria commerciale: 1E

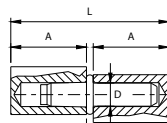

- Cerniera a goccia perno in acciaio rivestito ottone
- Drop hinge with brass-covered, steel pivot
- Paumelle à goutte avec pivot en acier revêtu de laiton
- Bandrolle mit Messing beschichtetem Zapfen aus Stahl

492

	L	A	D				
492T-100	98	48	Ø9	100 Kg*	40	4,5	2,216
492-120	118	58	Ø9	125 Kg*	40	7,0	2,893
492T-120	118	58	Ø9	125 Kg*	40	8,0	2,598
492-140	139	68	Ø9	180 Kg*	40	8,1	3,144
492T-140	139	68	Ø9	180 Kg*	40	9,5	2,773

* valore portata a coppia L/H=1 / capacity of couple hinges L/H=1

Categoria commerciale: 1E

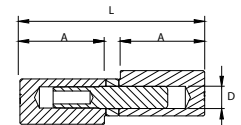

- Cerniera a goccia perno in acciaio con rondella
- Drop Hinge With Steel Pivot And Washer
- Paumelle à goutte avec pivot en acier avec rondelle
- Bandrolle mit Zapfen aus Stahl mit Unterlegscheibe

494

	L	A	D				
494-100	100	46	Ø12	150 Kg*	16	3,9	4,247
494T-100	100	46	Ø12	150 Kg*	16	3,9	5,096
494-150	149	71	Ø12	250 Kg*	16	5,4	4,553

* valore portata a coppia L/H=1 / capacity of couple hinges L/H=1

Categoria commerciale: 1E

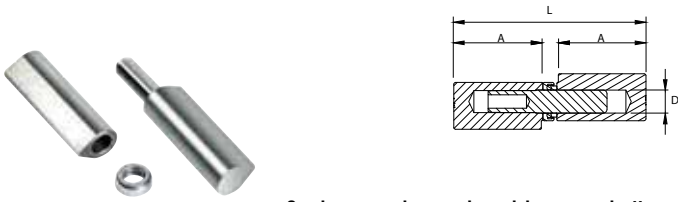

- Cerniera a goccia perno in acciaio con cuscinetto
- Drop Hinge With Steel Pivot And Bearing
- Paumelle à goutte avec pivot en acier avec roulement
- Bandrolle mit Zapfen aus Stahl mit Kugellager

495

	L	A	D				€
495-100	100	46	Ø12	150 Kg*	16	3,5	4,171
495PS-100 SP20	100	46	Ø12	150 Kg*	10	2,5	4,848
495PS-150 SP20	149	71	Ø12	250 Kg*	10	3,9	5,153
495T-100	100	46	Ø12	150 Kg*	16	4,2	5,005
495-150	149	71	Ø12	250 Kg*	16	5,1	4,618
495T-150	149	71	Ø12	250 Kg*	16	6,0	5,542

* valore portata a coppia L/H=1 / capacity of couple hinges L/H=1

Categoria commerciale: 1E

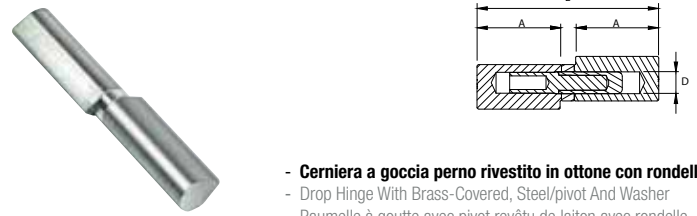

- Cerniera a goccia perno rivestito in ottone con rondella
- Drop Hinge With Brass-Covered, Steel/pivot And Washer
- Paumelle à goutte avec pivot revêtu de laiton avec rondelle
- Bandrolle mit Messing beschichtetem Zapfen aus Stahl mit Unterlegscheibe

496

	L	A	D				€
496-100	100	46	Ø12	100 Kg*	16	3,9	4,793
496T-100	100	46	Ø12	100 Kg*	16	4,3	5,752
496-150	149	71	Ø12	180 Kg*	16	5,6	5,579
496T-150	149	71	Ø12	180 Kg*	16	6,5	6,695

* valore portata a coppia L/H=1 / capacity of couple hinges L/H=1

Categoria commerciale: 1E



- Cerniera a goccia perno ottone con cuscinetto
- Drop hinge with brass pivot and bearing
- Paumelle à goutte avec pivot en laiton avec rondelle
- Bandrolle mit Zapfen aus Messing mit Kugellager

497

	L	A	D				€
497-100	100	46	Ø12	100 Kg*	16	4,2	5,656
497T-100	100	46	Ø12	100 Kg*	10	2,6	6,786
497T-100	100	46	Ø12	zinc 100 Kg*	10	2,6	7,466
497-150	149	71	Ø12	180 Kg*	16	5,8	6,223
497T-150	149	71	Ø12	180 Kg*	16	5,8	6,485
497Z-100	100	46	Ø12	zinc 100 Kg*	16	4,2	6,114
497Z-150	149	71	Ø12	zinc 180 Kg*	16	5,8	6,769
497PS-100	100	46	Ø12	100 Kg*	16	4,2	6,070
497PS-150	149	71	Ø12	180 Kg*	16	5,8	6,671

* valore portata a coppia L/H=1 / capacity of couple hinges L/H=1

Categoria commerciale: 1E



- Cerniera a goccia perno in acciaio rivestito ottone con cuscinetto
- Drop hinge with brass-covered, steel pivot and bearing
- Paumelle à goutte avec pivot en acier revêtu de laiton avec roulement
- Bandrolle mit Messing beschichtetem Zapfen aus Stahl mit Kugellager

498

	L	A	D				€
498-100	100	46	Ø12	100 Kg*	16	4,2	3,210
498T-100	100	46	Ø12	100 Kg*	16	4,2	3,852
498-150	149	71	Ø12	180 Kg*	16	5,6	3,789
498T-150	149	71	Ø12	180 Kg*	16	5,6	4,546
498Z-100	100	46	Ø12	zinc 100 Kg*	16	4,2	3,505
498Z-150	149	71	Ø12	zinc 180 Kg*	16	5,6	3,887

* valore portata a coppia L/H=1 / capacity of couple hinges L/H=1

Categoria commerciale: 1E



- Cerniera a goccia tornita perno acciaio regolabile 7 mm
- Turned drop hinge, 7mm adjustable, with steel pivot
- Paumelle à goutte tournée, réglable 7mm. avec pivot en acier
- Formgepresstes und 7 mm-verstellbares Tropfenband mit Zapfen aus Stahl

500

	R				€
500-150	146-153	300 Kg*	10	3,8	11,824

* valore portata a coppia L/H=1 / capacity of couple hinges L/H=1

Categoria commerciale: 1E

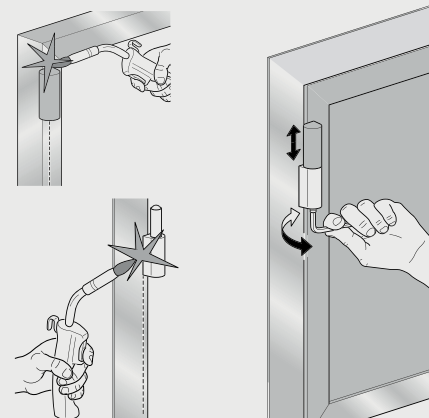

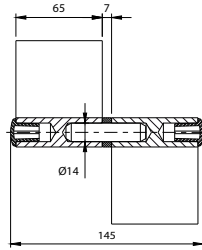

505

- Cerniera ala lunga reversibile con rondella perno acciaio
- Big hinge long wing steel pivot with washer
- Paumelle grande aile longue réversible pivot en acier avec rondelle
- Scharnier mit langem Flügel, Kugellager und Zapfen aus Stahl

505-150	600 Kg*	10	7,1	12,741

* valore portata a coppia L/H=1 / capacity of couple hinges L/H=1

Categoria commerciale: 1E

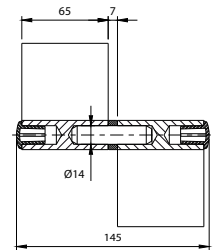

510

- Cerniera ala lunga reversibile con cuscinetto perno acciaio
- Big hinge long wing steel pivot with bearing
- Paumelle grande aile longue réversible pivot en acier avec roulement
- Scharnier mit langem Flügel, Kugellager und Zapfen aus Stahl

510-150	600 Kg*	10	7,1	14,554

* valore portata a coppia L/H=1 / capacity of couple hinges L/H=1

Categoria commerciale: 1E

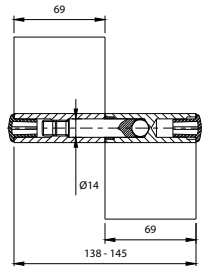

515

- Cerniera regolabile 7mm ala lunga perno acciaio
- Hinge, 7mm adjustable, with long wing and steel pivot
- Paumelle réglable 7mm, avec aile longue et pivot en acier
- 7 mm-verstellbares Scharnier mit langem Flügel und Zapfen aus Stahl

515-150	138-145	600 Kg*	10	7,4	15,766

* valore portata a coppia L/H=1 / capacity of couple hinges L/H=1

Categoria commerciale: 1E

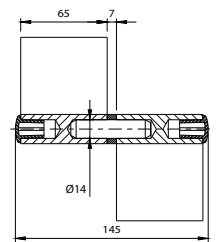

520

- Cerniera ala lunga reversibile perno ottone
- Hinge with reversible long wing and brass pivot
- Paumelle avec aile longue réversible et pivot en laiton
- Umkehrbares Scharnier mit langem Flügel und Zapfen aus Messing

520-150	450 Kg*	10	7,0	13,746

* valore portata a coppia L/H=1 / capacity of couple hinges L/H=1

Categoria commerciale: 1E

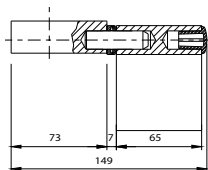

525

- Cerniera ala lunga reversibile e ala a goccia perno acciaio con cuscinetto
- Big hinge long and drop wing with bearing
- Paumelle grande aile longue réversible avec roulement
- Scharnier mit langem Flügel und Tropfenflügel, Zapfen aus Stahl und Kugellager

525-150	300 Kg*	10	5,7	8,199

1* valore portata a coppia L/H=1 / capacity of couple hinges L/H=1

Categoria commerciale: 1E

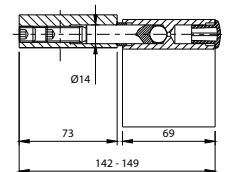

530

- Cerniera ala lunga reversibile perno ottone
- Hinge with reversible long wing and brass pivot
- Paumelle avec aile longue réversible et pivot en laiton
- Umkehrbares Scharnier mit langem Flügel und Zapfen aus Messing

530-150	138-145	300 Kg*	10	5,3	13,516

* valore portata a coppia L/H=1 / capacity of couple hinges L/H=1

Categoria commerciale: 1E

NEW

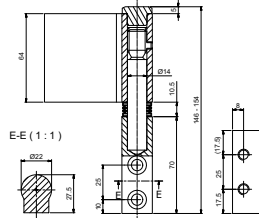

- Cerniera regolabile per blindato
- Adjustable Hinge right or left for blast doors
- Paumelle réglable pour portes blindées
- Verstellbares Scharnier

540

	R				€
540DX	146-154	350	10	6,8	14,880
540SX	146-154	350	10	6,8	14,880

* valore portata a coppia L/H=1 / capacity of couple hinges L/H=1

Categoria commerciale: 1E

NEW

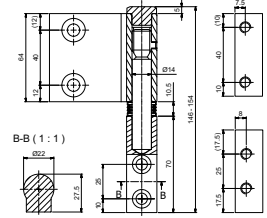

- Cerniera regolabile a fissare per blindato
- Adjustable Hinge to be fixed for blast doors
- Paumelle réglable pour portes blindées
- Verstellbares Scharnier

541

	R				€
541DX	146-154	350	10	7,5	15,136
541SX	146-154	350	10	7,5	15,136

* valore portata a coppia L/H=1 / capacity of couple hinges L/H=1

Categoria commerciale: 1E

NEW

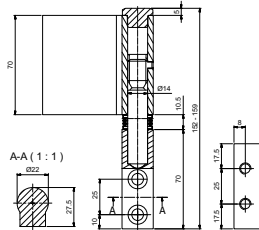

- Cerniera reversibile regolabile per blindato a fissare
- Adjustable Hinge right or left, to be fixed for blast doors
- Paumelle réglable réversible pour portes blindées
- Verstellbares Umkehrbares Scharnier

542-70

	R				€
542-70	152-159	350	10	6,9	15,495

* valore portata a coppia L/H=1 / capacity of couple hinges L/H=1

Categoria commerciale: 1E

NEW

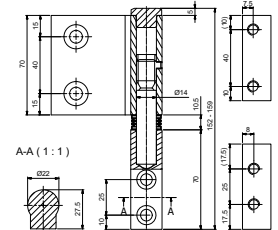

- Cerniera reversibile regolabile per blindato a fissare
- Adjustable Hinge right or left, to be fixed for blast doors
- Paumelle réglable réversible pour portes blindées
- Verstellbares Umkehrbares Scharnier

543-70

	R				€
543-70	152-159	350	10	7,5	16,779

* valore portata a coppia L/H=1 / capacity of couple hinges L/H=1

Categoria commerciale: 1E

NEW

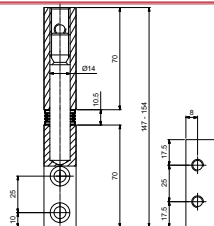

- Cerniera regolabile per blindato
- Adjustable Hinge right or left for blast doors
- Paumelle réglable pour portes blindées
- Verstellbares Scharnier

544

	R				€
544-150	147-154	350	10	6,1	14,674

* valore portata a coppia L/H=1 / capacity of couple hinges L/H=1

Categoria commerciale: 1E

NEW

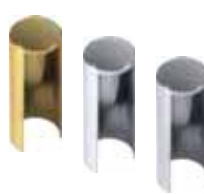

- Coperchio Copricerniera 495-496-497-498 L 150
- Cover for hinges 495-496-497-498 L 150
- Couverture pour paumelles 495-496-497-498 L 150
- Abdeckung für scharnier 95-496-497-498 L 150

545

		A	B	D			€
545-O	Ottonata / Brass plated	73	Ø22	Ø20	20	0,08	2,104
545-C	Cromato / Chrome	73	Ø22	Ø20	20	0,08	2,104
545-CS	Cromato Satinato / Chrome Mat	73	Ø22	Ø20	20	0,08	2,104

Categoria commerciale: 1E

NEW

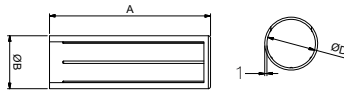

- Coperchio Copricerniera 575-576-577-578 L 150
- Cover for hinges 575-576-577-578 L 150
- Couverture pour paumelles 575-576-577-578 L 150
- Abdeckung für scharnier 575-576-577-578 L 150

546

		A	B	D			
546-O	Ottonata / Brass plated	73	Ø24	Ø22	20	0,08	2,107
546-C	Cromato / Chrome	73	Ø24	Ø22	20	0,08	2,107
546-CS	Cromato Satinato / Chrome Mat	73	Ø24	Ø22	20	0,08	2,107

Categoria commerciale: 1E

NEW

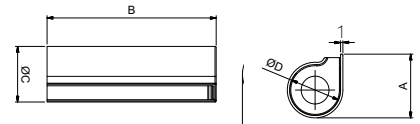

- Coperchio Copricerniera 540-541-542-543
- Cover for hinges 540-541-542-543
- Couverture pour paumelles 540-541-542-543
- Abdeckung für scharnier 540-541-542-543

547

		A	B	C	D			
547-DX-M	Marrone / Brown	29	75	Ø24	Ø22	20	0,13	1,103
547-SX-M	Marrone / Brown	29	75	Ø24	Ø22	20	0,13	1,103
547-DX-B	Bianco / White	29	75	Ø24	Ø22	20	0,13	1,103
547-SX-B	Bianco / White	29	75	Ø24	Ø22	20	0,13	1,103

Categoria commerciale: 1E

NEW

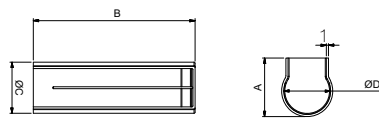

- Coperchio Copricerniera 540-541-542-543
- Cover for hinges 540-541-542-543
- Couverture pour paumelles 540-541-542-543
- Abdeckung für scharnier 540-541-542-543

548

		A	B	C	D			
548-27,5-M	Marrone / Brown	27,5	76	Ø24	Ø22	20	0,12	0,712
548-25,5-M	Marrone / Brown	25,5	76	Ø24	Ø22	20	0,12	0,712
548-27,5-B	Bianco / White	27,5	76	Ø24	Ø22	20	0,12	0,712
548-25,5-B	Bianco / White	25,5	76	Ø24	Ø22	20	0,12	0,712

Categoria commerciale: 1E



Perno Zincato

550

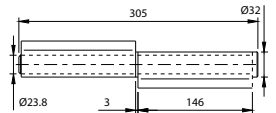

- Maxi cerniera a 2 ali
- Big hinge with 2 wings
- grande paumelle avec 2 ailes
- Maxi-Scharnier 2-teilig

550-300	800 Kg*	4	8,4		19,128

* valore portata a coppia L/H=1 / capacity of couple hinges L/H=1

Categoria commerciale: 1E



Perno Zincato

551

- Maxi cerniera a 3 ali
- Big hinge with 3 wings
- Grande paumelle avec 3 ailes
- Maxi-Scharnier 3-teilig

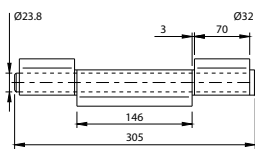

551-300	1000 Kg*	4	8,3		20,297

* valore portata a coppia L/H=1 / capacity of couple hinges L/H=1

Categoria commerciale: 1E



Perno Zincato

552

- Maxi cerniera a 4 ali
- Big hinge with 4 wings
- Grande paumelle avec 4 ailes
- Maxi-Scharnier 4-teilig

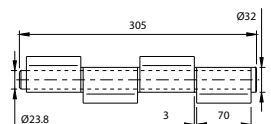

552-300	1300 Kg*	4	8,3		24,205

* valore portata a coppia L/H=1 / capacity of couple hinges L/H=1

Categoria commerciale: 1E

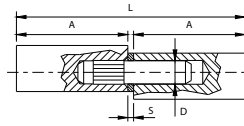

560

- Cerniera a goccia perno in acciaio con rondella
- Drop hinge with steel pivot and washer
- Paumelle à goutte avec pivot en acier avec rondelle
- Bandrolle mit Zapfen aus Stahl mit Unterlegscheibe

	L	A	D				€
560T-60	59,5	29	Ø6	75 Kg*	40	1,6	2,566
560T-60	zinc	59,5	29	Ø6	75 Kg*	40	3,079
560-80	80	39	Ø7	110 Kg*	50	4,1	2,096
560Z-80	zinc	80	39	Ø7	110 Kg*	50	2,515
560-100	98	48	Ø9	150 Kg*	40	6,0	2,620
560T-100	98	48	Ø9	150 Kg*	40	6,0	3,144
560-120	118	58	Ø9	225 Kg*	40	6,9	3,243
560T-120	118	58	Ø9	225 Kg*	40	6,9	3,891
560-140	138	68	Ø12	260 Kg*	20	6,7	4,400
560T-140	138	68	Ø12	260 Kg*	20	6,7	5,280
560-160	156	77	Ø12	300 Kg*	10	4,2	5,514
560-180	175	86	Ø12	330 Kg*	10	4,7	7,501

* valore portata a coppia L/H=1 / capacity of couple hinges L/H=1

Categoria commerciale: 1E

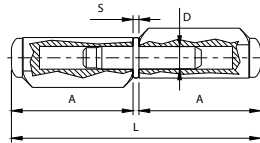

570

- Cerniera "Futura" perno in acciaio
- Drop hinge "Futura" with steel pin
- Paumelle "Futura" avec pivot en acier
- Bandrolle „Futura“ mit Zapfen aus Stahl

	L	A	D				€
570-40	40	19	Ø6	52 Kg*	40	1,2	0,666
570-60	60	29	Ø6	75 Kg*	40	1,3	0,732
570-80	80	39	Ø9	110 Kg*	40	3,3	0,819
570-100	98	48	Ø9	150 Kg*	40	3,9	0,906
570-120	119	58	Ø9	225 Kg*	40	6,9	1,485
570-140	139	68	Ø9	300 Kg*	40	7,8	1,758

* valore portata a coppia L/H=1 / capacity of couple hinges L/H=1

Categoria commerciale: 1E



574

- Cerniera "Futura" perno in acciaio con rondella
- Drop hinge "Futura" with steel pin and washer
- Paumelle "Futura" avec pivot en acier et rondelle
- Bandrolle „Futura“ mit Stift aus Stahl und Unterlegscheibe

	L	A	D				€
574-100	98	45	Ø14	150 Kg*	16	4,3	5,022
574-150	148	70	Ø14	300 Kg*	16	6,5	5,426

* valore portata a coppia L/H=1 / capacity of couple hinges L/H=1

Categoria commerciale: 1E

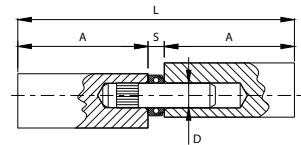

564

- Cerniera a goccia perno in acciaio con cuscinetto
- Drop hinge with steel pivot and bearing
- Paumelle à goutte avec pivot en acier avec roulement
- Bandrolle mit Zapfen aus Stahl mit Kugellager

	L	A	D				€
564-100	102	48	Ø9	150 Kg*	50	7,5	3,559
564T-100	102	48	Ø9	150 Kg*	50	8,5	4,271
564-120	122	58	Ø9	225 Kg*	40	7,0	3,701
564T-120	122	58	Ø9	225 Kg*	40	8,5	4,441
564-140	143	68	Ø12	260 Kg*	20	6,2	4,793
564T-140	143	68	Ø12	260 Kg*	20	7,5	5,752
564-160	161	77	Ø12	300 Kg*	10	4,3	4,531
564-180	180	86	Ø12	330 Kg*	10	4,8	7,348

* valore portata a coppia L/H=1 / capacity of couple hinges L/H=1

Categoria commerciale: 1E

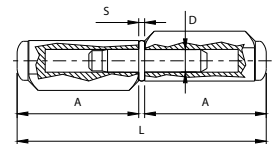

572

- Cerniera "Futura" perno in ottone
- Drop hinge "Futura" with brass pin
- Paumelle "Futura" avec pivot en laiton
- Bandrolle „Futura“ mit Zapfen aus Messing

	L	A	D				€
572-40	40	19	Ø6	30 Kg*	40	1,2	0,906
572-60	60	29	Ø6	45 Kg*	40	1,4	0,961
572-80	80	39	Ø9	75 Kg*	40	3,2	1,288
572-100	98	48	Ø9	110 Kg*	40	3,9	1,627
572-120	119	58	Ø9	150 Kg*	40	6,8	2,184
572-140	139	68	Ø9	180 Kg*	40	8,0	2,478

* valore portata a coppia L/H=1 / capacity of couple hinges L/H=1

Categoria commerciale: 1E



575

- Cerniera "Futura" perno in acciaio con cuscinetto
- Drop hinge "Futura" with steel pin and bearing
- Paumelle "Futura" avec pivot en acier et bague à bille
- Bandrolle „Futura“ mit Stift aus Stahl und Kugellager

	L	A	D				€
575-100	98	45	Ø14	150 Kg*	16	4,8	3,909
575-150	148	70	Ø14	300 Kg*	16	6,5	4,302

* valore portata a coppia L/H=1 / capacity of couple hinges L/H=1

Categoria commerciale: 1E

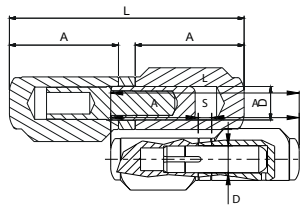

576

- Cerniera "Futura" perno in ottone con rondella
- Drop hinge "Futura" with brass pin and washer
- Paumelle "Futura" avec pivot en laiton et rondelle
- Bandrolle „Futura“ mit Stift aus Messing und Unterlegscheibe

		L	A	D				€
576-100	22x27	98	45	Ø14	110 Kg*	10	4,8	5,175
576-140	18x22	142	68	Ø10	150 Kg*	16	6,1	3,592
576-150	22x27	148	70	Ø14	180 Kg*	16	6,5	4,618

* valore portata a coppia L/H=1 / capacity of couple hinges L/H=1

Categoria commerciale: 1E

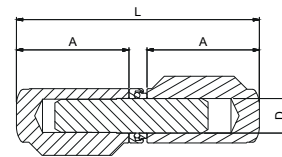

577

- Cerniera Futura perno in ottone con cuscinetto
- Drop hinge "Futura" with brass pin and bearing
- Paumelle "Futura" avec pivot en laiton et bague à bille
- Bandrolle „Futura“ mit Stift aus Messing und Kugellager

		L	A	D				€
577-100	22x27	98	45	Ø14	110 Kg*	16	4,6	5,874
577-140	18x22	142	68	Ø10	150 Kg*	16	4,1	4,673
577-150	22x27	148	70	Ø14	180 Kg*	16	6,1	6,431
577Z-150 ZINC	22x27	148	70	Ø14	180 Kg*	16	6,1	6,540
577PS-150	22x27	148	70	Ø14	180 Kg*	16	6,1	7,848

* valore portata a coppia L/H=1 / capacity of couple hinges L/H=1

Categoria commerciale: 1E

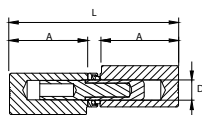

578

- Cerniera "Futura" perno rinforzato e rivestito in ottone, con cuscinetto
- Drop hinge "Futura" with reinforced, brass-covered pivot and bearing
- Paumelle Futura avec pivot renforcé et revêtu de laiton avec roulement
- Bandrolle "Futura" mit verstärktem und mit Messig beschichtetem Zapfen mit Kugellager

		L	A	D				€
578-100	22x27	98	45	Ø14	110 Kg	16	4,4	3,385
578-140	18x22	142	68	Ø10	150 Kg	16	4,5	2,577
578-150	22x27	148	70	Ø14	180 Kg	16	6,3	3,941

Categoria commerciale: 1E

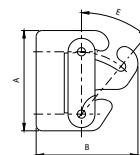

600

- Cerniera per vasistas
- Hinge for transom windows
- Paumelle vasistas
- Scharnier für Klappfenster

	A	B	E			€
600-65	67	68	40°	40	4,1	1,670
600-85	90	92	48°	20	3,1	2,184

Categoria commerciale: 1G

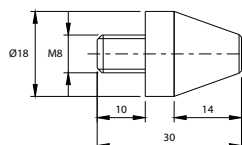

590

- Piolo filettato per porte blindate
- Threaded peg for armoured doors
- Piquet taraudé pour portes blindées
- Sicherheitsdorn mit Gewinde für gepanzerte Türen

					€
590	zinc	100	3,1		1,026

Categoria commerciale: 1G

NEW

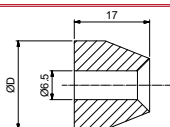

591

- Piolo filettato per porte blindate
- Threaded peg for armoured doors
- Piquet taraudé pour portes blindées
- Sicherheitsdorn mit Gewinde für gepanzerte Türen

		D			€
591-16	zinc	Ø16	100	2,20	0,639
591-18	zinc	Ø18	100	2,90	0,725
591-20	zinc	Ø20	100	3,60	0,846

Categoria commerciale: 1G

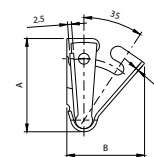

606

- Cerniera a compasso per vasistas
- Compass hinge for transom windows
- Paumelle à compas pour vasistas
- Scharnier für Klappfenster

	A	B			€
606-65	60	50	40	4,8	3,341
606-85	80	64	25	5,4	4,247

Categoria commerciale: 1G

NEW

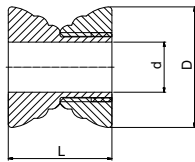

- Distanziatore regolabile per grate
- Adjustable spacer for grate
- Entretoises réglables pour grille
- Verstellbar Abstandsstück

607

	D	L	d				€
607-30	Ø30	30-40	Ø14,5	zinc	50	4,4	3,449
607-35	Ø35	30-40	Ø14,5	zinc	50	5,8	3,461

Categoria commerciale: 1G

NEW

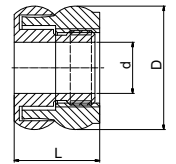

- Distanziatore regolabile per grate
- Adjustable spacer for grate
- Entretoises réglables pour grille
- Verstellbar Abstandsstück

608

	D	L	d				€
608-30	Ø30	23-33	Ø10,5	zinc	50	4,1	3,718
608-35	Ø35	23-33	Ø14,5	zinc	50	5,3	3,718

Categoria commerciale: 1G

NEW

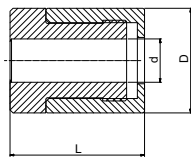

- Distanziatore regolabile per grate
- Adjustable spacer for grate
- Entretoises réglables pour grille
- Verstellbar Abstandsstück

609

	D	L	d				€
609-30	Ø30	45-65	Ø14,5	zinc	50	8,3	7,826
609-35	Ø35	45-65	Ø14,5	zinc	50	12,2	7,826

Categoria commerciale: 1G

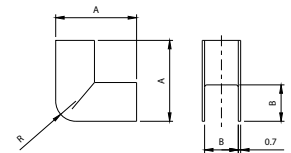

- Copri angolo per finestre
- Cover-angle for windows
- Couvre-coin pour fenêtres
- Winkelbedeckung für Fenster

615

	A	B	R				€
615-10	60	48	6	zinc	500	3,0	0,546
615-12	80	62	9	zinc	500	3,5	0,579

Categoria commerciale: 1G



- Chiavistello Zincato
- Galvanised latch
- Verrou zingué
- Verzinkter Riegel

620

				€
620	zinc	50	2,1	2,795

Categoria commerciale: 1G



Zama Zincata

625

- Chiavetta in zama
- Zinked key
- Clé en zamac
- Schlüssel aus Zamak

					€
625	Quadrata	zinc	50	1,1	1,398
625	Triangolare	zinc	50	1,2	1,365

Categoria commerciale: 1G



627

- **Chiavistello a leva zincato**
- Galvanised lever latch
- Verrou à levier zingué
- Riegel mit Hebel verzinkt

627P	zinc	20	1,3	3,974
627G	zinc	20	2,7	4,356

Categoria commerciale: 1G



628

- **Chiave in alluminio per chiavistello Art.627**
- Aluminium key for latch
- Clé en aluminium pour verrou
- Aluminium Schlüssel für Riegel

628	20	0,4	1,976

Categoria commerciale: 1G



630

- **Cricchetto per vasistas**
- Catch for transom windows
- Loqueteau pour vasistas
- Schnappschluss für Klappfenster

630	Piccola zinc	50	3,5	2,424

Categoria commerciale: 1G



635

- **Cricchetto per vasistas**
- Catch for transom windows
- Loqueteau pour vasistas
- Schnappschluss für Klappfenster

635	Medio	50	4,3	1,638

Categoria commerciale: 1G



640

- **Cricchetto per vasistas**
- Catch for transom windows
- Loqueteau pour vasistas
- Schnappschluss für Klappfenster

640	Grande	25	4,1	2,577

Categoria commerciale: 1G

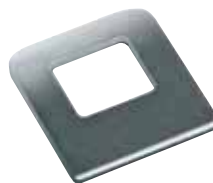

645

- **Ferrogliera per art. 630**
- Staple for art.630
- Gâche pour art.630
- Befestigungsklammer für Art. 630

645	200	4,8	0,699

Categoria commerciale: 1G



- Ferrogliera per art. 630 – 635 – 640
- Staple for art.630 -635-640
- Gâche pour art.630-635-640
- Befestigungsklammer für Art. 630-635-640

650

650	zinc	200	6,2	0,753

Categoria commerciale: 1G



- Ferrogliera per art. 630 – 635 – 640
- Staple for art.630 -635-640
- Gâche pour art.630-635-640
- Befestigungsklammer für Art. 630-635-640

655

655	zinc	200	3,6	0,579

Categoria commerciale: 1G



- Maniglia a blocco
- Lever bolt
- Poignée de blocage
- Fensterverschluss

660DX

660DX	zinc	20	3,0	3,341

Categoria commerciale: 1H



- Maniglia a blocco
- Lever bolt
- Poignée de blocage
- Fensterverschluss

660SX

660SX	zinc	20	3,0	3,341

Categoria commerciale: 1H



- Maniglia a blocco reversibile
- Reversible lever bolt
- Poignée de blocage réversible
- Fensterverschluss doppelseitig

662

662	zinc	20	4,5	5,000

Categoria commerciale: 1H



- Maniglia a leva per coppia movimenti
- Lever handle
- Béquille à levier
- Hebel.Drüscher

670

670	zinc	6	2,17	17,403

Categoria commerciale: 1G



- Maniglione curvo Ø15 mm
- Bended pull handle dia.15mm
- Poignée courbée dia.15mm
- Gebogener Stosgriff Durchm.15 mm

671

	L					€
671P	215	Ø15	Ral 9005	10	6,4	10,197
671G	265	Ø15	Ral 9005	10	7,1	10,481

Categoria commerciale: 1H



- Catenaccio a saldare
- Bolt to be welded
- Verrou à souder
- Stossriegel zum Anschweißen

673

					€
673	zinc	25	4,2		2,653

Categoria commerciale: 1D

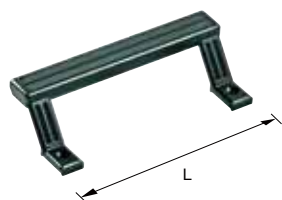

- Maniglia di trascinamento in zama presso fusa
- Die-cast alloy handle
- Béquille en zamac moulée sous pression
- Torgriff aus Druckguss-Zamak

674

	L				€
674	162	Ral 9005	20	4,2	18,200

Categoria commerciale: 1H



- Maniglione zancato Ø15 mm
- Bended pull handle dia.15mm
- Poignée courbée dia.15mm
- Gebogener Stosgriff Durchm. 15 mm

675

	L					€
675P	215	Ø15	Ral 9005	10	6,1	10,918
675G	265	Ø15	Ral 9005	10	6,5	11,824

Categoria commerciale: 1H

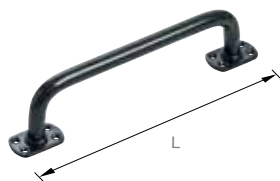

- Maniglione diritto Ø15 mm
- Straight pull handle dia.15mm
- Poignée droite dia.15mm
- Gerader Stosgriff Durchm. 15mm

677

	L					€
677P	215	Ø15	Ral 9005	10	4,5	10,612
677G	265	Ø15	Ral 9005	10	5,4	11,824

Categoria commerciale: 1H



- Maniglione tubolare zancato
- Bended pull handle
- Poignée courbée
- Gebogener rohrförmiger Stosgriff

678

	L					€
678P	234	Ø20	Ral 9005	10	4,2	25,472
678G	351	Ø25	Ral 9005	10	9,0	36,390

Categoria commerciale: 1H

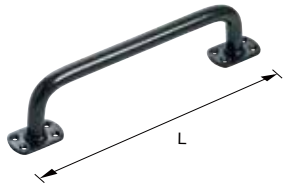

- Maniglione tubolare diritto
- Straight pull handle
- Poignée droite
- Rohrförmiger gerader Stossgriff

679

	L					€
679P	234	Ø20	Ral 9005	10	3,20	16,683
679G	351	Ø25	Ral 9005	10	6,70	21,225

Categoria commerciale: 1H

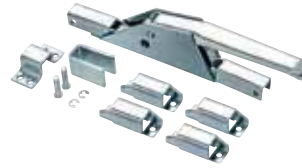

- Cariglione "Car" aste esterne 14x14 mm
- "Car" lever bolt internal bars 14x14mm
- Crémone à levier "Car" tringles intérieures 14x14mm
- Treibriegel "Car" Innenstange 14x14mm

680

					€
680	zinc	5	4,5		18,200

Categoria commerciale: 1B



- Cariglione "Car" con cilindro aste esterne 14x14 mm
- "Car" lever bolt external bars 14x14mm
- Crémone à levier "Car" tringles extérieures 14x14mm
- Treibriegel "Car" mit Zylinder und Außenstangen - 14x14 mm

682

				€
682	zinc	5	5,0	28,813

Categoria commerciale: 1B

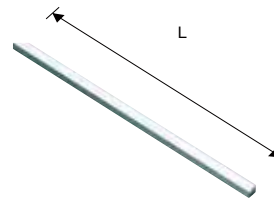

- Asta per cariglione art. 686 10x10 mm
- Bar for lever bolt art.686 10X10mm
- Tringle pour crémonne art.686 10X10mm
- Stange für Treibriegel art.686 10X10mm

683

	L				€
683	1500	zinc	1	1,2	12,130
683	2000	zinc	1	1,6	15,504

Categoria commerciale: 1B



- Cariglione "Bon" con cilindro
- "Bon" lever bolt with cylinder
- Crémone à levier "Bon" avec cylindre
- Treibriegel "Bon" mit Zylinder

684

				€
684	700	5	3,6	56,828

Categoria commerciale: 1B



- Cariglione per aste interne Ø6 mm
- Lever bolt internal bars dia.6mm
- Crémone à levier tringles intérieures dia 6mm
- Treibriegel für Innenstange Durchm. 6mm

685

				€
685	Ral 9005	10	5,0	15,165

Categoria commerciale: 1B



- Cariglione per aste esterne 10x10 mm
- Lever bolt for external bars 10x10mm
- Crémone à levier pour tringles extérieures 10x10mm
- Treibriegel für Außenstange Durchm. 10X10mm

686

686	Ral 9005	10	5,0	15,165

Categoria commerciale: 1B



- Asta forata 14x14 mm per cariglione art. 680 - 682
- Holed bar 14x14 mm for lever bolt art.680-682
- Tringle percée 14x14mm pour crémones art.680-682
- Stange mit Bohrungen 14x14mm für Treibriegel art.680-682

687

687	L=1500	zinc	1	2,3
687	L=2000	zinc	1	3,10

Categoria commerciale: 1B

NEW



- Asta per serrature
- Rod for locks
- Tringle pour serrures
- Stange für Schlösser

688

688	zinc	1200	8	50	10,5

Categoria commerciale: 1D

NEW



- Puntale per asta serrature
- Rod tip for locks
- Pointe de Tringle pour serrures
- Spitze für SchlösserStange

689

689-8	zinc	Ø8	50	1,6	3,671
689-10	zinc	Ø10	50	2,35	3,680
689-12	zinc	Ø12	50	3,3	3,680
689-14	zinc	Ø14	50	4,45	3,680

Categoria commerciale: 1D



- Catenaccio ad incasso doppia mandata leva ottone
- Flush mounted bolt with 2 locking and brass lever
- Verrou à bascule avec 2 sorties et levier bichromaté
- Kantenriegel mit Doppel-Bewegung und Hebel aus Messing

700Z

700Z	zinc	10	3,2	7,577

Categoria commerciale: 1D

NEW



- Catenaccio a leva con contropiastra
- Flush bolt with staple
- Verrou à levier avec contreplaqué
- Kantenriegel mit Gegenplatte

703

703-150	Bronzato / Bronze plated	150	15	6	0,475
703-200	Bronzato / Bronze plated	200	15	6	0,55
703-250	Bronzato / Bronze plated	250	15	6	0,66
703-300	Bronzato / Bronze plated	300	15	6	0,852
703-150	Ottonato / Brass plated	150	15	6	0,475
703-200	Ottonato / Brass plated	200	15	6	0,55
703-250	Ottonato / Brass plated	250	15	6	0,66
703-300	Ottonato / Brass plated	300	15	6	0,852

Categoria commerciale: 1D



- **Catenaccio ad incasso una mandata leva zincata**
- Flush mounted bolt with 1 locking, galvanised lever
- Verrou à bascule avec 1 sortie et levier zingué
- Kantenriegel mit Einzel-Bewegung und Hebel aus Messing

704

704-16	zinc	20	2,1	1,976	
704-20	zinc	20	2,1	1,976	
704-24	zinc	20	2,2	1,976	
704-24	leva ottone / lever brass	zinc	20	3,035	

Categoria commerciale: 1D



- **Catenaccio ad incasso una mandata leva ottone**
- Flush mounted bolt with 1 locking, brass lever
- Verrou à bascule avec 1 sortie et levier bichromaté
- Kantenriegel mit Einzel-Bewegung und Hebel aus Messing

705

705-16	zinc	20	2,0	5,688	
705-20	zinc	20	2,2	5,688	
705-24	zinc	20	2,3	5,688	

Categoria commerciale: 1D



- **Catenaccio per porte blindate una mandata leva ottone nichelato corsa 30 mm**
- Flush mounted bolt for armoured doors with 1 locking and nickel-plate brass lever stroke 30 mm
- Verrou à bascule pour portes blindées avec 1 sortie et levier en laiton nickelé course 30 mm
- Kantenriegel für gepanzerte Türe mit Einzel-Bewegung und Hebel aus nickelplattiertem Messing 30 mm Hub

706

706	zinc	6	1,8	15,449	

Categoria commerciale: 1D



- **Catenaccio per porte blindate doppia mandata leva ottone nichelato corsa 15 mm**
- Flush mounted bolt for armoured doors with 2 lockings and nickel-plate brass lever stroke 15 mm
- Verrou à bascule pour portes blindées avec 2 sorties et levier en laiton nickelé course 15 mm
- Kantenriegel für gepanzerte Türe mit Doppel-Bewegung und Hebel aus nickelplattiertem Messing 15 mm Hub

707

707	zinc	6	2,1	19,281	

Categoria commerciale: 1D



- **Catenaccio per porte blindate doppia mandata leva ottone nichelato corsa 21 mm**
- Flush mounted bolt for armoured doors with 2 lockings and nickel-plate brass lever stroke 21 mm
- Verrou à bascule pour portes blindées avec 2 sorties et levier en laiton nickelé course 21 mm
- Kantenriegel für gepanzerte Türe mit Doppel-Bewegung und Hebel aus nickelplattiertem Messing 21 mm Hub

708

708	zinc	6	2,9	28,354	

Categoria commerciale: 1D

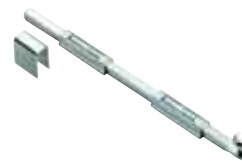

- **Catenaccio punta quadrata ∇ 10**
- Square bolt
- Verrou carré
- Stangenriegel mit viereckiger Spitze

710

710-130	zinc	10	2,0	4,182	
710-300	zinc	10	3,9	5,874	
710-500	zinc	10	6,0	7,850	

Categoria commerciale: 1D



- **Catenaccio punta tonda Ø10**
- Round bolt
- Verrou avec pointe ronde
- Stangenriegel mit runder Spitze

712

Icona	Material	Quantità	Dimensione	Prezzo
	zinc	10	2,0	4,182
	zinc	10	3,9	5,874
	zinc	10	6,0	7,850

Categoria commerciale: 1D



- **Catenaccio punta quadrata 14**
- Square bolt
- Verrou avec pointe carrée
- Stangenriegel mit viereckiger Spitze

714

Icona	Material	Quantità	Dimensione	Prezzo
	zinc	5	3,7	8,199
	zinc	5	6,5	11,879

Categoria commerciale: 1D



- **Catenaccio punta tonda Ø14**
- Round bolt
- Verrou avec pointe ronde
- Stangenriegel mit runder Spitze

716

Icona	Material	Quantità	Dimensione	Prezzo
	zinc	5	3,7	8,199
	zinc	5	6,5	11,879

Categoria commerciale: 1D



- **Catenaccio punta tonda Ø19**
- Round bolt
- Verrou avec pointe ronde
- Stangenriegel mit runder Spitze

719

Icona	Material	Quantità	Dimensione	Prezzo
	zinc	2	4,24	33,592

Categoria commerciale: 1D



- **Catenaccio a leva punta arrotondata**
- Round-pointed bolt with lever
- Verrou à levier avec pointe arrondie
- Stangenriegel mit abgerundetem Hebelspitze

720

Icona	Material	Quantità	Dimensione	Prezzo
	zinc	10	3,2	3,789
	zinc	10	3,7	4,553
	zinc	10	4,4	5,306
	zinc	10	5,4	7,206

Categoria commerciale: 1D



- **Catenaccio a leva pesante**
- Heavy bolt with lever
- Verrou lourd à levier
- Stangenriegel mit großem Hebel

725

Icona	Material	Quantità	Dimensione	Prezzo
	zinc	10	7,8	6,977
	zinc	10	9,7	7,577
	zinc	10	12,2	9,859

Categoria commerciale: 1D

NEW



- Paletti automatici per cancelli a 2 ante
- Automatic bolt for 2 leaf gates
- Verrous autobloquants
- Automatisch Riegel

732Z

📄	🔗	🗨️	👤	€
732Z	zinc	6	2,53	24,108

Categoria commerciale: 1D



- Catenaccio medio a saldare
- Medium bolt to be welded
- Verrou moyen à souder
- Stangenriegel zum Anschweißen medium

735

📄	🔗	🗨️	👤	€
735-150	zinc	10	2,0	2,893
735-200	zinc	10	2,6	3,221
735-250	zinc	10	3,2	3,341
735-300	zinc	10	3,9	3,756
735-400	zinc	10	5,1	4,717
735-500	zinc	10	6,4	5,448
735-600	zinc	10	7,1	7,457
735-800	zinc	10	10,2	9,160

Categoria commerciale: 1D



- Catenaccio a saldare asta tonda Ø12mm
- Bolt to be welded round bar dia.12mm
- Verrou à souder tringle ronde dia.12mm
- Stossriegel mit abgerundeter Stange zum Anschweißen

737

📄	🔗	🗨️	👤	€
737-150	zinc	10	2,3	5,044
737-200	zinc	10	3,0	5,252
737-250	zinc	10	3,8	6,092
737-300	zinc	10	4,5	6,594
737-400	zinc	10	6,0	8,330
737-500	zinc	10	6,5	9,728
737-600	zinc	10	9,1	13,626
737-800	zinc	10	12,2	16,508

Categoria commerciale: 1D



- Catenaccio leggero 14mm
- Light bolt
- Verrou léger
- Kleiner Stossriegel

740

📄	🔗	🗨️	👤	€
740-150	zinc	10	1,8	4,313
740-200	zinc	10	2,2	4,367
740-250	zinc	10	2,9	4,826
740-300	zinc	10	3,4	5,219
740-400	zinc	10	4,4	6,627
740-500	zinc	10	5,4	7,184
740-600	zinc	10	6,6	7,763
740-800	zinc	10	8,5	9,881

Categoria commerciale: 1D



- Catenaccio pesante 25mm
- Heavy bolt
- Verrou lourd
- Grosser Stossriegel

745

📄	🔗	🗨️	👤	€
745-200	zinc	6	3,5	6,485
745-250	zinc	6	4,5	7,075
745-300	zinc	6	5,3	7,926
745-400	zinc	6	6,8	9,717
745-500	zinc	6	8,3	11,912
745-600	zinc	6	10,2	17,622
745-800	zinc	6	13,3	21,017

Categoria commerciale: 1D

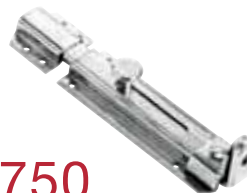

- Catenaccio porta lucchetto medio 16mm
- Medium padlock-bolt
- Verrou porte-cadenas moyen
- Hangschlossriegel medium

750

📄	🔗	🗨️	👤	€
NEW 750-100	zinc	10	2,7	3,018
750-150	zinc	10	2,7	3,865
750-200	zinc	10	3,4	4,924

Categoria commerciale: 1D



- Catenaccio porta lucchetto asta tonda Ø12
- Padlock-bolt with round rod
- Verrou porte-cadenas tringle ronde
- Hangschlossriegel mit abgerundeter Stange

752

📄	📏	🗣️	🔒	€
752-130	bronz	10	3,1	7,806
752-145	bronz	10	3,8	10,012
752-170	bronz	10	4,7	11,071
752-195	bronz	10	5,6	12,588

Categoria commerciale: 1D



- Catenaccio porta lucchetto pesante 25mm
- Heavy padlock-bolt
- Verrou porte-cadenas lourde
- Hangschlossriegel gross

755

📄	📏	🗣️	🔒	€
755-200	zinc	4	3,6	12,130
755-300	zinc	4	4,7	15,547
755-400	zinc	4	6,0	17,436
755-500	zinc	4	7,5	20,340

Categoria commerciale: 1D



- Catenaccio porta lucchetto asta tonda Ø14
- Padlock-bolt with round rod d. 14 mm
- Verrou porte-cadenas tringle ronde dia.14mm
- Hangschlossriegel mit abgerundeter Stange d. 14 mm

760

📄	📏	🗣️	🔒	€
760-180	zinc	10	4,2	7,064
760-215	zinc	10	4,9	8,276
760-270	zinc	10	6,1	10,296

Categoria commerciale: 1D



- Catenaccio ad avvitare 18mm
- Bolt to be screwed
- Verrou à visser
- Stossriegel zum Anschrauben

800

📄	📏	🗣️	🔒	€
800-200	zinc	10	2,3	3,941
800-250	zinc	10	2,9	4,520
800-300	zinc	10	3,5	4,902
800-400	zinc	10	4,8	5,568
800-500	zinc	10	6,0	6,201
800-600	zinc	10	7,2	8,265
800-800	zinc	10	9,8	9,750

Categoria commerciale: 1D



- Catenaccio trasversale leggero 16mm
- Transverse light bolt
- Verrou transversal léger
- Horizontalstossriegel klein

805

📄	📏	🗣️	🔒	€
805-80	bronz	10	1,2	3,264
805-120	bronz	10	1,8	3,636
805-160	bronz	10	2,3	4,018
805-200	bronz	10	2,8	4,476

Categoria commerciale: 1D



- Catenaccio trasversale medio 16mm
- Transverse medium bolt
- Verrou transversal moyen
- Horizontalstossriegel medium

810

📄	📏	🗣️	🔒	€
810-150	bronz	10	2,0	5,459
810-200	bronz	10	2,6	5,754
810-250	bronz	10	3,1	5,896
810-300	bronz	10	3,6	6,889
810-400	bronz	10	4,6	8,254

Categoria commerciale: 1D



- Catenaccio trasversale pesante ∇ 25mm
- Transverse heavy bolt
- Verrou transversal lourd
- Horizontalstossriegel gross

820

				€
820-200	bronz	4	2,4	10,023
820-300	bronz	4	3,4	12,992
820-400	bronz	4	4,5	15,951
820-500	bronz	4	5,9	17,720

Categoria commerciale: 1D



- Catenaccio verticale medio ∇ 16mm
- Vertical bolt
- Verrou vertical moyen
- Vertikaler Stossriegel medium

825

				€
825-150	bronz	10	2,2	5,022
825-200	bronz	10	2,9	5,514
825-250	bronz	10	3,6	6,300
825-300	bronz	10	4,3	7,053
825-400	bronz	10	5,7	8,614
825-500	bronz	10	7,0	10,154
825-600	bronz	10	8,4	16,589
825-800	bronz	10	11,1	17,796

Categoria commerciale: 1D



- Incontro per catenaccio art. 825
- Strike for bolt art.825
- Gâche pour verrou art. 825
- Schliesskloben für Stossriegel Artikel 825

827

				€
827	bronz	50	1,3	0,983

Categoria commerciale: 1D



- Catenaccio verticale pesante ∇ 25mm
- Heavy vertical bolt
- Verrou vertical lourd
- Vertikaler Stossriegel gross

835

				€
835-200	bronz	4	2,7	9,520
835-300	bronz	4	4,0	12,414
835-400	bronz	4	5,3	14,357
835-500	bronz	4	6,6	16,770
835-600	bronz	4	7,9	21,498
835-800	bronz	4	10,5	24,293

Categoria commerciale: 1D



- Incontro per catenaccio art. 835
- Strike for bolt art.835
- Gâche pour verrou art. 835
- Schliesskloben für Stossriegel Artikel 835

837

				€
837	bronz	50	3,8	1,812

Categoria commerciale: 1D



- Catenaccio ad avvitare zancato
- Bolt to be screwed
- Verrou à visser
- Gekröpfter Stossriegel zum Anschrauben

840

				€
840-200	zinc	10	3,0	5,295
840-300	zinc	10	4,4	6,496
840-400	zinc	10	5,8	8,025
840-500	zinc	10	7,1	9,750
840-600	zinc	10	8,5	10,449
840-1000	zinc	10	13,7	22,830

Categoria commerciale: 1D



- Catenaccio ad avvitare
- Bolt to be screwed
- Verrou à visser
- Stossriegel zum Anschrauben

840D

Icona	Material	Quantità	Prezzo unitario	Prezzo totale
	zinc	10	2,9	5,295
	zinc	10	4,3	6,496
	zinc	10	5,5	8,025
	zinc	10	7,0	9,750
	zinc	10	8,4	10,449

Categoria commerciale: 1D



- Incontro per catenaccio art. 800
- Strike for bolt art.800
- Gâche pour verrou art. 800
- Schliesskloben für Stossriegel Artikel 800

852

Icona	Material	Quantità	Prezzo unitario	Prezzo totale
	zinc	50	1,0	1,118

Categoria commerciale: 1D



- Incontro per catenaccio art. 735
- Strike for bolt art.735
- Gâche pour verrou art. 735
- Schliesskloben für Stossriegel Artikel 735

855

Icona	Material	Quantità	Prezzo unitario	Prezzo totale
	zinc	50	1,5	1,048

Categoria commerciale: 1D



- Incontro per catenaccio art. 740
- Strike for bolt art.740
- Gâche pour verrou art. 740
- Schliesskloben für Stossriegel Artikel 740

857

Icona	Material	Quantità	Prezzo unitario	Prezzo totale
	zinc	50	2,9	1,048

Categoria commerciale: 1D



- Catenaccio pesante asta tonda Ø16mm
- Heavy bolt with round rod
- Verrou lourd tringle ronde
- Stossriegel mit abgerundeter Stange gross

860

Icona	Material	Quantità	Prezzo unitario	Prezzo totale
	zinc	4	3,9	18,659

Categoria commerciale: 1D



- Catenaccio pesante asta tonda porta lucchetto
- Heavy padlock-bolt with round rod
- Verrou lourde porte-cadenas tringle ronde
- Hangschlossriegel mit abgerundeter Stange gross

862

Icona	Material	Quantità	Prezzo unitario	Prezzo totale
	zinc	4	3,5	21,574
	zinc	4	5,2	30,549
	zinc	4	10,2	45,779

Categoria commerciale: 1D

NEW

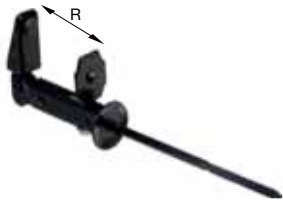

- **Fermascuro a fissare regolabile a triangolo, doppio gommino**
- Shutter stop to be fixed, triangle shape, adjustable, double rubber pads
- Arrêt de vent à fixer réglable à triangle, double caoutchouc
- Fensterblendefeststeller, einstellbar dreieckig zu befestigen, Doppelgummi

865

	R			€
865-05	17-52	20	4,9	6,819

Categoria commerciale: 1G

NEW

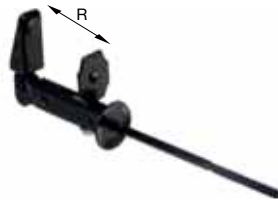

- **Fermascuro a fissare regolabile a triangolo, doppio gommino**
- Shutter stop to be fixed, triangle shape, adjustable, double rubber pads
- Arrêt de vent à fixer double réglage court, double caoutchouc
- Fensterblendefeststeller mit doppelter Regelung zu befestigen, kurz, Doppelgummi

866

	R			€
866-10	17-52	20	5,2	7,158

Categoria commerciale: 1G

NEW

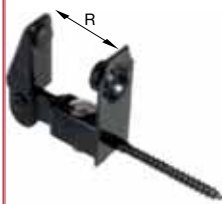

- **Fermascuro a fissare regolabile a triangolo, doppio gommino**
- Shutter stop to be fixed, triangle shape, adjustable, double rubber pads
- Arrêt de vent à fixer double réglage court, double caoutchouc
- Fensterblendefeststeller mit doppelter Regelung zu befestigen, kurz, Doppelgummi

867

	R			€
867-05	33-53	20	5,7	6,226

Categoria commerciale: 1G

NEW



- **Fermascuro a fissare doppia regolazione corto, doppio gommino**
- Shutter stop to be fixed, double adjustment, short, double rubber pads
- Arrêt de vent à fixer double réglage court, double caoutchouc
- Fensterblendefeststeller mit doppelter Regelung zu befestigen, kurz, Doppelgummi

868

	R			€
868-05	17-58	20	5,4	7,016
868-15	17-58	20	6,0	7,871

Categoria commerciale: 1G

NEW

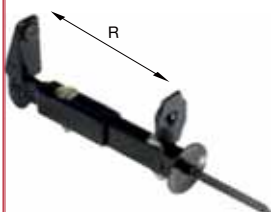

- **Fermascuro a fissare doppia regolazione lungo, doppio gommino**
- Shutter stop to be fixed, double adjustment, long, double rubber pads
- Arrêt de vent à fixer double réglage long, double caoutchouc
- Fensterblendefeststeller, mit doppelter Regelung zu befestigen lang, Doppelgummi

869

	R			€
869-05	17-146	20	6,3	8,034
869-15	17-146	20	6,4	10,391

Categoria commerciale: 1G

NEW



- **Fermascuro a fissare regolabile "Ometto" corto**
- "Ometto" shutter stop to be fixed, adjustable, short
- Arrêt de vent à fixer réglable "Ometto" court
- Fensterblendefeststeller einstellbar zu befestigen, "Ometto" kurz

871

	R			€
871-05	22-70	20	4,5	7,124
871-10	22-70	20	4,8	6,596

Categoria commerciale: 1G

NEW

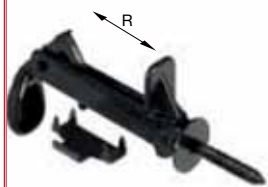

- **Fermascuro a fissare regolabile "Pigna"**
- "Pigna" shutter stop to be fixed, adjustable
- Arrêt de vent à fixer réglable "Pigna"
- Fensterblendefeststeller einstellbar zu befestigen "Pigna"

873

	R			€
873-05	0-60	20	4,25	6,636
873-10	0-60	20	4,55	6,883

Categoria commerciale: 1G

NEW

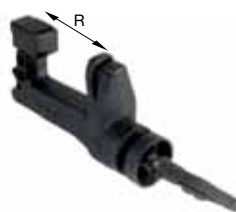

- **Fermascuro a scatto in plastica**
- Snap locking plastic shutter stop
- Arrêt de vent à enclenchement
- Auslösender Fensterblendefeststeller

874

	R			€
874-05	40-56	20	2	4,595

Categoria commerciale: 1G

NEW



- **Fermainposta**
- Shutter stop
- Arrêt de vent
- Fensterladen

875

				€
875-05		20	10,0	6,613
875-10		20	13,0	7,317

Categoria commerciale: 1G

NEW



- **Fermapersiana**
- Roller shutter stop
- Arrêt de vent
- Balkonfensterladenfeststeller

876-05



- **Distanziale per fermapersiana**
- Shim for Roller shutter stop
- Épaisseur pourr arrêt de vent
- Distanzstück für Balkonfensterladenfeststeller

876-10

				€
876-05		20	3,6	7,085
876-10		20	0,2	1,061

Categoria commerciale: 1G

NEW



- **Kit fermascuro magnetico**
- Magnetic shutter stop kit
- Kit bloque-volet magnétique
- Garnitur Jalousiehalter mit Magnet

877

	D			€
877	43	12	5,5	24,168

Categoria commerciale: 1G

NEW

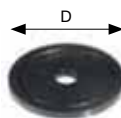

- **Spessore per fermascuro magnetico**
- Shim for magnetic shutter stop
- Épaisseur pour bloque-volet magnétique
- Distanzstück für magnetischen Jalousiehalter

877S

	D			€
877S	43	100	0,5	0,427

Categoria commerciale: 1G

NEW

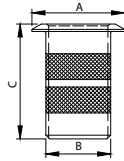
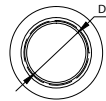

- Pozzetto in ottone
- Brass covering hole
- Bouchon en laiton
- Messingbolzen

878

	D	A	B	C			€
878-06	Ø6	Ø12	Ø7,5	30	100	1,1	0,946
878-08	Ø8	Ø16	Ø9,5	30	100	1,2	1,060
878-10	Ø10	Ø18	Ø11,5	30	100	1,7	1,333
878-12	Ø12	Ø20	Ø13,5	30	100	1,9	1,396
878-14	Ø14	Ø22	Ø15,5	30	100	2,5	1,584
878-16	Ø16	Ø25	Ø17,5	30	50	1,5	2,408
878-18	Ø18	Ø30	Ø19,5	30	50	1,2	3,000
878-20	Ø20	Ø30	Ø21,5	30	50	1,3	3,011
878-22	Ø22	Ø32	Ø23,5	30	50	1,5	3,211

Categoria commerciale: 1G

NEW

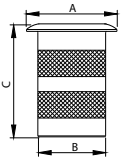
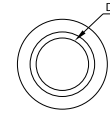

- Pozzetto antipolvere in ottone con molla di ritorno
- Anti-dust well in brass with return spring
- Bouchon antipoussière en laiton avec ressort de retour
- Staubbolzen aus Messing mit Rückholfeder

879

	D	A	B	C			€
879-06	Ø6	Ø15	Ø10	30	100	1,1	1,857
879-08	Ø8	Ø18	Ø12	30	100	1,2	2,075
879-10	Ø10	Ø20	Ø14	30	100	1,7	2,384
879-12	Ø12	Ø22	Ø16	30	100	1,9	2,583
879-14	Ø14	Ø24	Ø18	30	100	2,5	2,994
879-16	Ø16	Ø28	Ø22	30	50	1,5	4,334
879-18	Ø18	Ø28	Ø22	30	50	1,2	4,631
879-20	Ø20	Ø30	Ø24	30	50	1,3	4,641
879-22	Ø22	Ø32	Ø26	30	50	1,5	5,109

Categoria commerciale: 1G







A close-up, black and white photograph of industrial machinery, specifically a series of rollers and pulleys. The rollers are arranged in a row, receding into the background, creating a sense of depth. The lighting highlights the metallic surfaces and the circular shapes of the rollers.

Life
made
easy

COMUNELLO 
GATE DIVISION

Cantilever Components

LEGENDA

	Articolo / <i>Article</i>		Pezzi per confezione / <i>Pieces per pack</i>
	Regolazione / <i>Regulation</i>		Peso confezione / <i>Weight of pack</i>
	Portata / <i>Capacity</i>		Prezzo / <i>Price</i>
	Portata singolo carrello / <i>Capacity of single carriage</i>		Su richiesta / <i>On request</i>
	Abbinamento monorotaia / <i>Related monorail</i>		Lubrificazione / <i>Greasing</i>
	Abbinamento tiranti / <i>Related tie roads</i>		Cuscinetti / <i>Bearings</i>
			Accessori in acciaio inox / <i>S-Steel accessories</i>



CGS-250.5 MINI PICCOLO GRANDE

CARATTERISTICHE

- Corpo multistrato brevettato
- Cuscinetti silenziosi di nuova generazione schermati per una migliore protezione dalla polvere; adatti a temperature che vanno dai -30° ai +80°
- 4 ruote di supporto per ogni carrello
- Ruota centrale di allineamento
- Perno centrale di rotazione

FEATURES

- Patented multiplate body
- Noiseless bearings of new generation shielded to protect against dust suitable for temperatures from -30 ° C to + 80 ° C
- 4 support wheels for each carriage
- Alignment Central wheel
- Central rotation pin

MULTIPLATE
BODY

ZRS
BEARINGS



- Carrello auto portante 5 ruote per cancelli a sbalzo
- 5 wheels cantilever carriage for gates
- Chariot autoportant 5 roues pour portails
- 5-rädrieger Laufwagen für freitragende Tore

CGS-250.5M

CGS-250.5M	450 Kg	CGS-245M	4 x CGS-348 M16	zinc	1	5,0	118,275

Categoria commerciale: 1Q

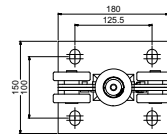
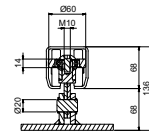
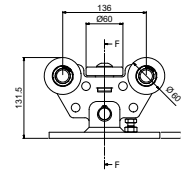

- Carrello auto portante 5 ruote per cancelli a sbalzo
- 5 wheels cantilever carriage for gates
- Chariot autoportant 5 roues pour portails
- 5-rädrieger Laufwagen für freitragende Tore

CGS-250.5P

CGS-250.5P	750 Kg	CGS-245P	6 x CGS-348 M16	zinc	1	10,6	188,030

Categoria commerciale: 1Q

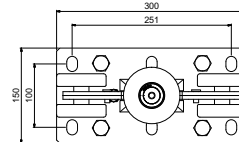
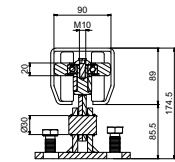
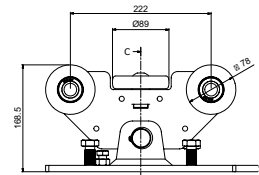

- Carrello auto portante 5 ruote per cancelli a sbalzo
- 5 wheels cantilever carriage for gates
- Chariot autoportant 5 roues pour portails
- 5-rädrieger Laufwagen für freitragende Tore

CGS-250.5G

CGS-250.5G	1400 Kg	CGS-245G	6 x CGS-348 M20	zinc	1	26,6	424,590

Categoria commerciale: 1Q

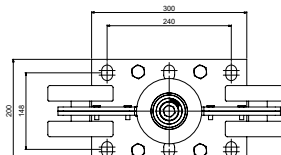
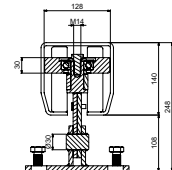
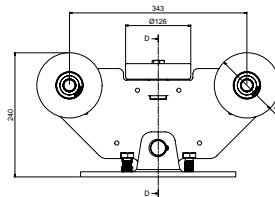

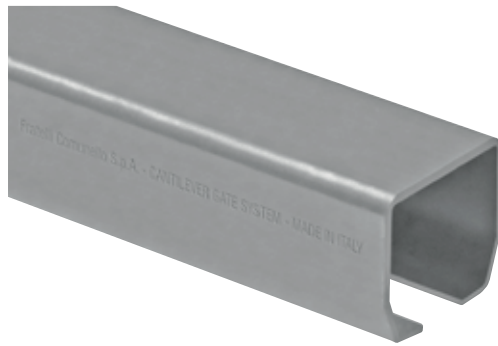

CGS-245 MINI PICCOLO GRANDE

- Monorotaia per cancelli auto-portanti
- Monorail for cantilever gates
- Rails pour portails autoportants
- Einfachschiene für selbsttragende Tore

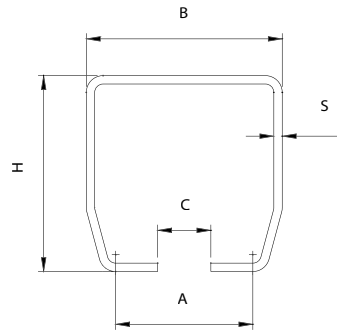

GREZZA

			L	B	H	S			€	
	CGS-245M	Mini	Raw	3000	68	68	3,5	1	18,3	97,050
	CGS-245M	Mini	Raw	6000	68	68	3,5	1	36,5	192,583
	CGS-245P	Piccolo	Raw	3000	100	89	5	1	35,0	172,865
	CGS-245P	Piccolo	Raw	6000	100	89	5	1	70,0	342,705
NEW	CGS-245P	Piccolo	Raw	9000	100	89	5	1	105,0	514,040
	CGS-245G	Grande	Raw	3000	140	140	6	1	67,0	348,765
	CGS-245G	Grande	Raw	6000	140	140	6	1	134,0	697,540

ZINCATA

	CGS-245M	Mini	Zinc	3000	68	68	3,5	1	18,3	103,110
	CGS-245M	Mini	Zinc	6000	68	68	3,5	1	36,5	201,677
	CGS-245P	Piccolo	Zinc	3000	100	89	5	1	35,0	197,135
	CGS-245P	Piccolo	Zinc	6000	100	89	5	1	71,0	376,060
NEW	CGS-245P	Piccolo	Zinc	9000	100	89	5	1	105,0	564,090
	CGS-245G	Grande	Zinc	3000	140	140	6	1	67,0	379,095
	CGS-245G	Grande	Zinc	6000	140	140	6	1	134,0	743,035

Categoria commerciale: 1R

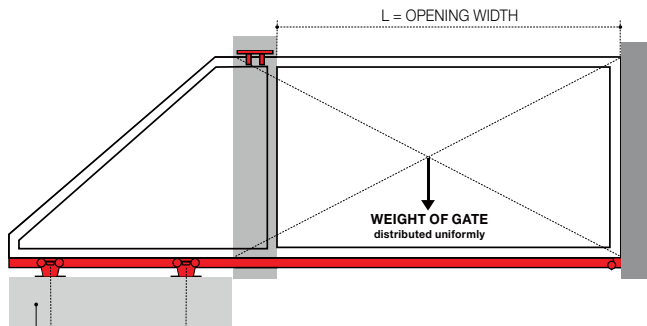

CGS-250.5 M (F1max = 450 Kg)										
Weight (Kg)	L=2 m		L=2,5 m		L=3 m		L=3,5 m			
	FA (M)	I (M)	FA (M)	I (M)	FA (M)	I (M)	FA (M)	I (M)	FA (M)	I (M)
75	0,90	0,30	1,00	0,40	1,10	0,50	1,20	0,60		
100	1,00	0,40	1,10	0,50	1,20	0,60	1,40	0,80		
125	1,20	0,60	1,30	0,70	1,40	0,80	1,60	1,00		
150	1,30	0,70	1,50	0,90	1,70	1,10	1,90	1,30		

CGS-250.5 P (F1max = 750 Kg)										
Weight (Kg)	L=2,5 m		L=3 m		L=3,5 m		L=4 m		L=4,5 m	
	FA (M)	I (M)	FA (M)	I (M)	FA (M)	I (M)	FA (M)	I (M)	FA (M)	I (M)
150	1,20	0,50	1,30	0,60	1,40	0,70	1,60	0,90	1,70	1,00
175	1,30	0,60	1,40	0,70	1,60	0,90	1,70	1,00	1,90	1,20
200	1,40	0,70	1,60	0,90	1,70	1,00	1,90	1,20	2,10	1,40
225	1,50	0,80	1,70	1,00	1,90	1,20	2,10	1,40	2,30	1,60
250	1,70	1,00	1,90	1,20	2,10	1,40	2,30	1,60	2,50	1,80

CGS-250.5G (F1max = 1400 Kg)										
Weight (Kg)	L=5 m		L=5,5 m		L=6 m		L=6,5 m		L=7 m	
	FA (M)	I (M)	FA (M)	I (M)	FA (M)	I (M)	FA (M)	I (M)	FA (M)	I (M)
300	2,20	1,30	2,40	1,50	2,60	1,70	2,70	1,80	2,90	2,00
350	2,50	1,60	2,70	1,80	2,90	2,00	3,10	2,20	3,30	2,40
400	2,70	1,80	3,00	2,10	3,20	2,30	3,50	2,60	3,70	2,80
450	3,10	2,20	3,30	2,40	3,60	2,70	3,90	3,00	4,20	3,30

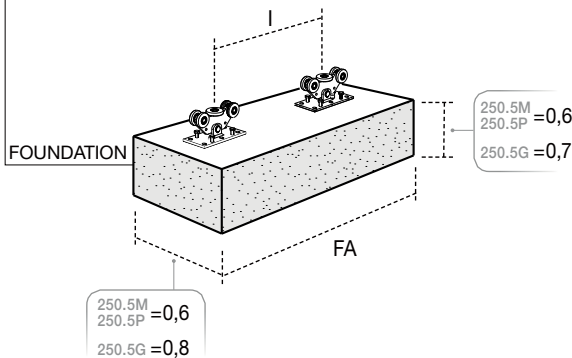

Per maggiori informazioni consultare il configuratore online
For further information please use our online configurator



CGS-350.5 MINI PICCOLO GRANDE

CARATTERISTICHE

FEATURES

- Corpo monoblocco che assicura resistenza alla struttura
- Indicato per i climi più umidi in quanto evita la corrosione del carrello
- Cuscinetti silenziosi di nuova generazione schermati per una migliore protezione dalla polvere; adatti a temperature che vanno dai -30° ai +80°
- 4 ruote di supporto per ogni carrello
- Ruota centrale di allineamento
- Perno centrale di rotazione

- Monoblock body that ensures strenght to the structure
- Suitable to humid climate to avoid the carriage corrosion
- Noiseless bearings of new generation shielded to protect against dust suitable for temperatures from -30 ° C to + 80 ° C
- 4 support wheels for each carriage
- Alignment Central wheel
- Central rotation pin



- Carrello auto portante 5 ruote per cancelli a sbalzo
- 5 wheels cantilever carriage for gates
- Chariot autoportant 5 roues pour portails
- 5-rädriger Laufwagen für freitragende Tore

CGS-350.5M

CGS-350.5M	600 Kg	CGS-345M	4 x CGS-348 M16	zinc 1 5,2 136,475

Categoria commerciale: 1Q



- Carrello auto portante 5 ruote per cancelli a sbalzo
- 5 wheels cantilever carriage for gates
- Chariot autoportant 5 roues pour portails
- 5-rädriger Laufwagen für freitragende Tore

CGS-350.5P

CGS-350.5P	1000 Kg	CGS-345P	6 x CGS-348 M16	zinc 1 11,0 206,230

Categoria commerciale: 1Q



- Carrello auto portante 5 ruote per cancelli a sbalzo
- 5 wheels cantilever carriage for gates
- Chariot autoportant 5 roues pour portails
- 5-rädriger Laufwagen für freitragende Tore

CGS-350.5G

CGS-350.5G	2000 Kg	CGS-345G	6 x CGS-348 M20	zinc 1 37,0 485,240

Categoria commerciale: 1Q

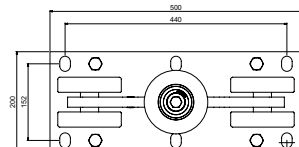
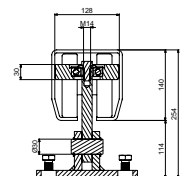
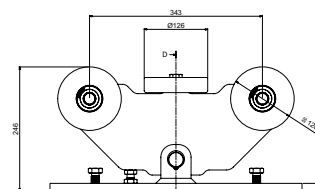
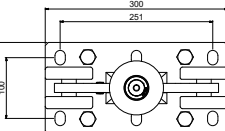
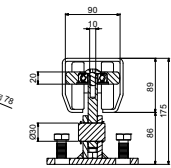
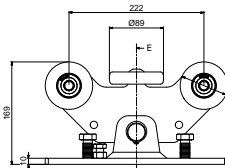
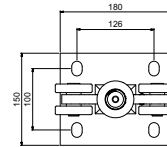
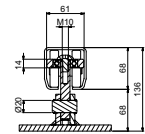
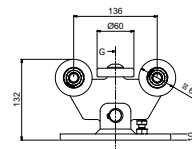

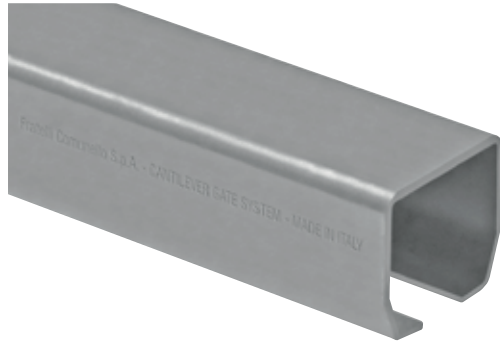

CGS-345 MINI PICCOLO GRANDE

- Monorotaia per cancelli auto-portanti
- Monorail for cantilever gates
- Rails pour portails autoportants
- Einfachschiene für selbsttragende Tore

GREZZA

			L	B	H	S			€	
	CGS-345M	Mini	Raw	3000	68	68	3,5	1	18,3	97,050
	CGS-345M	Mini	Raw	6000	68	68	3,5	1	36,5	194,100
	CGS-345P	Piccolo	Raw	3000	100	89	5	1	35,0	175,900
	CGS-345P	Piccolo	Raw	6000	100	89	5	1	70,0	351,800
NEW	CGS-345P	Piccolo	Raw	9000	100	89	5	1	105,0	527,700
	CGS-345G	Grande	Raw	3000	140	140	6	1	67,0	405,425
	CGS-345G	Grande	Raw	6000	140	140	6	1	134,0	758,189

ZINCATO

	CGS-345M	Mini	zinc	3000	68	68	3,5	1	18,3	103,110
	CGS-345M	Mini	zinc	6000	68	68	3,5	1	36,5	200,160
	CGS-345P	Piccolo	zinc	3000	100	89	5	1	35,0	212,290
	CGS-345P	Piccolo	zinc	6000	100	89	5	1	70,0	439,755
NEW	CGS-345P	Piccolo	zinc	9000	100	89	5	1	105,0	659,630
	CGS-345G	Grande	zinc	3000	140	140	6	1	67,0	470,085
	CGS-345G	Grande	zinc	6000	140	140	6	1	134,0	879,510

Categoria commerciale: 1R

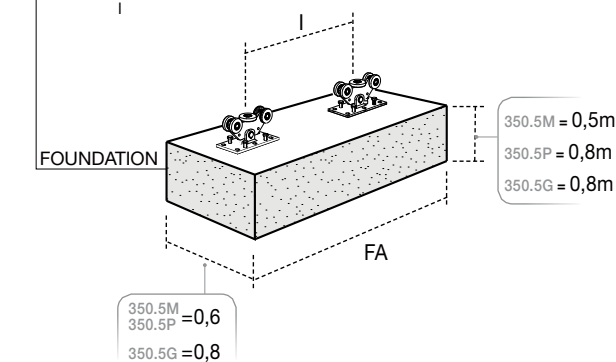
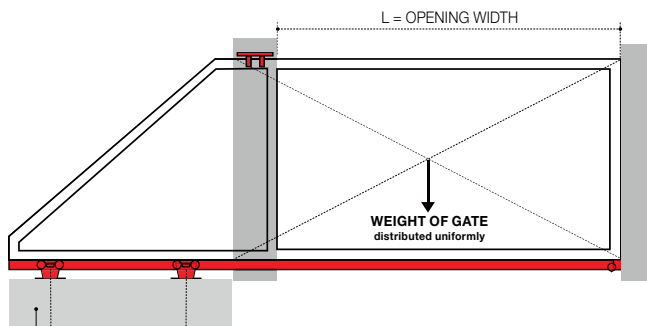
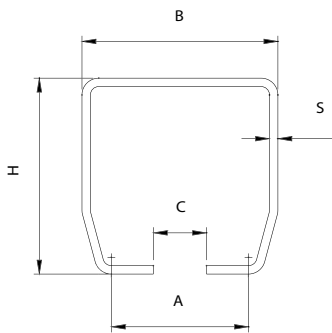

CGS-350.5 M (F1max = 600 Kg)										
	L=3 m		L=3,5 m		L=4 m		L=4,5 m		L=5 m	
Weight (Kg)	FA (m)	I (m)	FA (m)	I (m)	FA (m)	I (m)	FA (m)	I (m)	FA (m)	I (m)
100	1,30	0,40	1,40	0,50	1,50	0,60	1,60	0,70	1,70	0,80
125	1,50	0,60	1,60	0,70	1,70	0,80	1,80	0,90	1,90	1,00
150	1,60	0,70	1,70	0,80	1,80	0,90	2,00	1,10	2,10	1,20
175	1,80	0,90	1,90	1,00	2,00	1,20	2,20	1,30	2,40	1,50
200	1,90	1,00	2,10	1,20	2,30	1,40	2,50	1,60	2,70	1,80
225	2,10	1,20	2,30	1,40	2,50	1,70	2,80	1,90	3,00	2,10
250	2,40	1,50	2,60	1,70	2,90	2,00	3,10	2,20	3,40	2,50

CGS-350.5 P (F1max = 1000 Kg)										
	L=4 m		L=5 m		L=6 m		L=7 m		L=8 m	
Weight (Kg)	FA (m)	I (m)	FA (m)	I (m)	FA (m)	I (m)	FA (m)	I (m)	FA (m)	I (m)
250	1,70	1,00	2,00	1,30	2,30	1,60	2,70	2,00	3,10	2,40
275	1,80	1,10	2,20	1,50	2,50	1,80	2,90	2,20	3,30	2,60
300	2,00	1,30	2,30	1,60	2,70	2,00	3,20	2,50	3,60	3,00
325	2,10	1,40	2,50	1,80	3,00	2,30	3,50	2,80	4,00	3,30
350	2,30	1,60	2,70	2,00	3,20	2,50	3,80	3,10	4,40	3,70
375	2,50	1,80	3,00	2,30	3,50	2,80	4,10	3,40	4,80	4,10
400	2,70	2,00	3,20	2,50	3,80	3,10	4,50	3,80	5,20	4,60

CGS-350.5 G (F1max = 2000 Kg)										
	L=6 m		L=7 m		L=8 m		L=9 m		L=10 m	
Weight (Kg)	FA (m)	I (m)	FA (m)	I (m)	FA (m)	I (m)	FA (m)	I (m)	FA (m)	I (m)
400	2,20	1,30	2,50	1,60	2,80	1,90	3,10	2,20	3,50	2,60
450	2,40	1,50	2,70	1,80	3,00	2,10	3,40	2,50	3,80	2,90
500	2,60	1,70	2,90	2,00	3,30	2,40	3,70	2,80	4,10	3,20
550	2,80	1,90	3,20	2,30	3,60	2,70	4,00	3,10	4,50	3,60
600	3,00	2,10	3,40	2,50	3,90	3,00	4,40	3,50	4,90	4,00
650	3,20	2,40	3,70	2,80	4,20	3,30	4,80	3,90	5,40	4,50
700	3,50	2,60	4,00	3,10	4,60	3,70	5,20	4,30	5,90	5,00

Per maggiori informazioni consultare il configuratore online
For further information please use our online configurator

NEW

CGS-350.5XL



CARATTERISTICHE

- Corpo monoblocco che assicura resistenza alla struttura in acciaio
- Indicato per i climi più umidi in quanto evita la corrosione del carrello
- Cuscinetti obliqui a sfere a doppia corona schermati per una migliore protezione dalla polvere; adatti a temperature che vanno dai -30° ai +80°
- 4 ruote di supporto per ogni carrello
- Ruota centrale di allineamento
- Perno centrale di rotazione

FEATURES

- Monoblock body that ensures strength to the structure in steel
- Suitable to humid climate to avoid the carriage corrosion
- Double row angular shielded contact ball bearing to protect against dust suitable for temperatures from -30 ° C to + 80 ° C
- 4 support wheels for each carriage
- Alignment Central wheel
- Central rotation pin



Carrello auto portante 5 ruote per cancelli a sbalzo

5 wheels cantilever carriage for gates
 Chariot autoportant 5 roues pour portails
 5-rädriger Laufwagen für freitragende Tore

CGS-350.5XL	6500 Kg	CGS-345XL	4 x CGS-348 M16	zinc	1	69	1637,70
Categoria commerciale: 1Q							

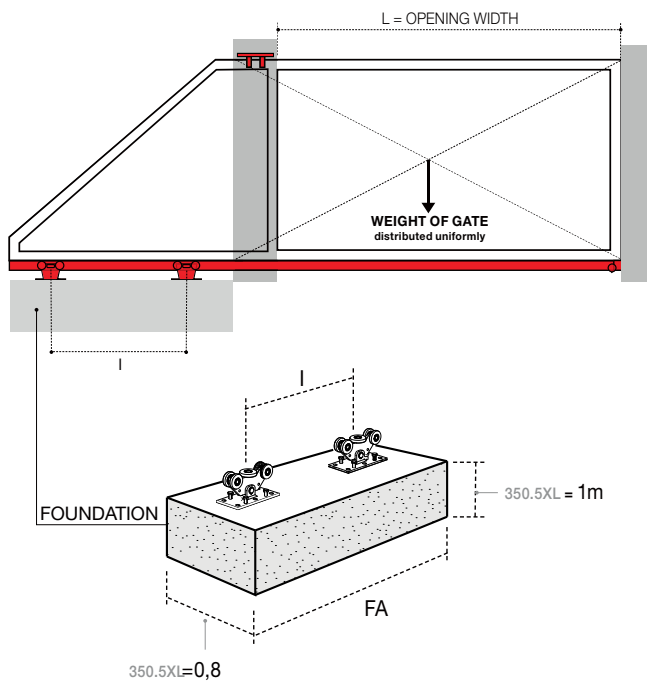
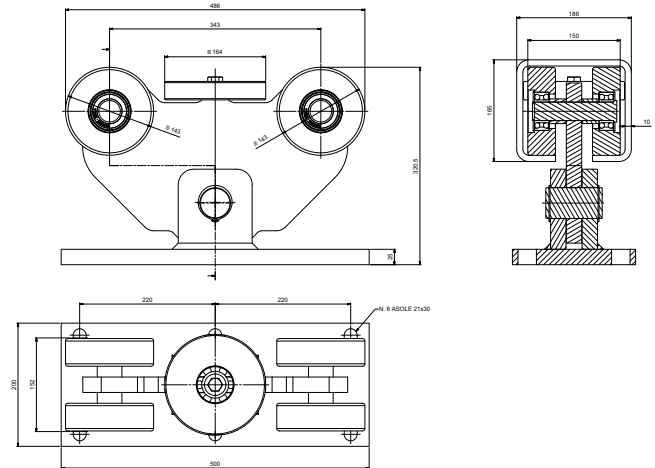

CGS-350.5XL (F1 max = 6500 Kg)								
Weight (Kg)	L=10 m		L=12 m		L=15 m		L=20 m	
	FA (m)	I (m)	FA (m)	I (m)	FA (m)	I (m)	FA (m)	I (m)
1500	5,00	2,40	5,00	3,0	5,90	4,14	8,20	6,40
2000	5,20	3,40	6,10	4,3	7,64	5,84	10,9	9,10
2500	6,60	4,80	7,80	6,0	10,0	8,20	14,7	12,9
3000	8,40	6,6	10,2	8,40	-	-	-	-

NEW

CGS-345XL

- **Monorotaia per cancelli auto-portanti**
- Monorail for cantilever gates
- Rails pour portails autoportants
- Einzelschiene für selbsttragende Tore



			L	B	H	S			€
CGS-345XL	XL	Raw	5800	186	165	10	1	136,0	3.072,00

Categoria commerciale: 1Q

- Acciaio strutturato / Structured steel

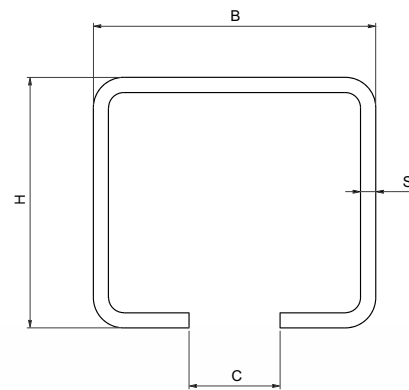

Per maggiori informazioni consultare il configuratore online
For further information please use our online configurator



CGA-350.5 AL. MINI PICCOLO

CARATTERISTICHE

- Corpo monoblocco che assicura resistenza alla struttura
- Indicato per i climi più umidi in quanto evita la corrosione del carrello
- I cuscinetti di nuova generazione schermati e silenziosi proteggono i carrelli dalla polvere; adatti a temperature che vanno dai -20° ai +60°.
- 4 ruote di supporto in nylon per monorotaia in alluminio
- Rotella centrale di allineamento
- Perno centrale di rotazione

FEATURES

- Monoblock body that ensures strength to the structure.
- Suitable to the humid climate to avoid the carriage corrosion
- Noiseless bearings of new generation shielded to protect against dust suitable for temperatures from -20 °C to + 60 °C
- 4 support nylon wheels specifically for aluminum monorail
- Alignment central wheel
- Central rotation pin



- Carrello autoportante 5 ruote in nylon per cancelli a sbalzo
- 5 nylon wheels cantilever carriage for gates
- Chariot autoportant 5 roues en nylon pour portails
- Laufwagen mit 5 Nylon-Rollen für freitragende Tore

CGA-350.5M

CGA-350.5M	450 Kg	CGA-345M	4 x CGS-348 M16	zinc	1	4,5
Categoria commerciale: 1Q						

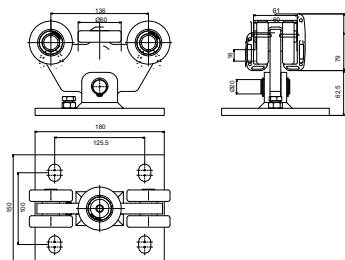

- Carrello autoportante 5 ruote in nylon per cancelli a sbalzo
- 5 nylon wheels cantilever carriage for gates
- Chariot autoportant 5 roues en nylon pour portails
- Laufwagen mit 5 Nylon-Rollen für freitragende Tore

CGA-350.5P

CGA-350.5P	1000 Kg	CGA-345P	6 x CGS-348 M16	zinc	1	8,3
Categoria commerciale: 1Q						

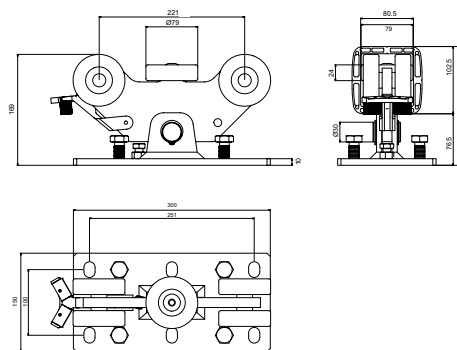



CGA-345 MINI PICCOLO ALLUMINIO ALUMINUM

- Monorotaia per cancelli auto-portanti
- Monorail for cantilever gates
- Rails pour portails autoportants
- Einzelschiene für selbsttragende Tore

			L	A	B	H	C			€
CGA-345M	Mini	Raw	3000	61	83	79	23	1	12	194,340
CGA-345M	Mini	Raw	6000	61	83	79	23	1	24	418,520
CGA-345P	Piccolo	Raw	3000	80,5	106,5	102,5	30	1	16	297,210
CGA-345P	Piccolo	Raw	6000	80,5	106,5	102,5	30	1	32	588,360

Categoria commerciale: 1R

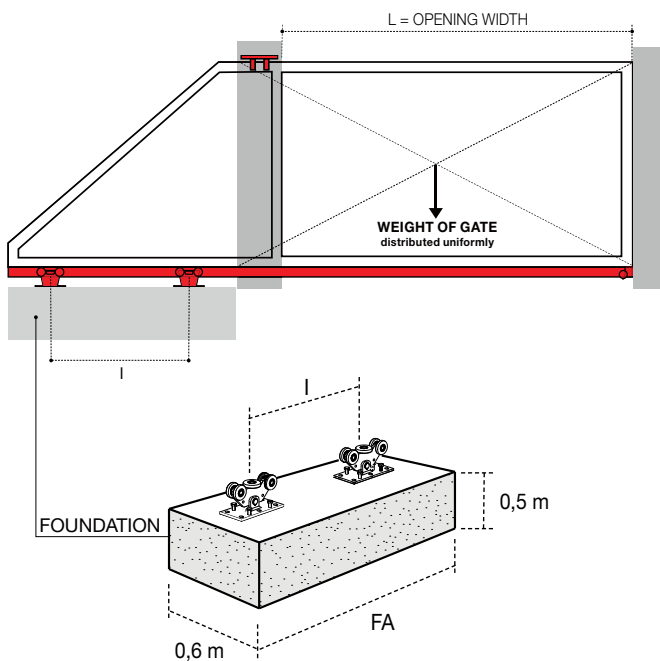
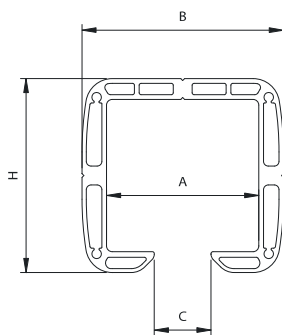

CGA-350.5 M (F1max = 450 Kg)								
	L=2 m		L=2,5 m		L=3 m		L=3,5 m	
Weight (Kg)	FA (M)	I (M)	FA (M)	I (M)	FA (M)	I (M)	FA (M)	I (M)
75	0,90	0,30	1,00	0,40	1,10	0,50	1,20	0,60
100	1,00	0,40	1,10	0,50	1,20	0,60	1,40	0,80
125	1,20	0,60	1,30	0,70	1,40	0,80	1,60	1,00
150	1,30	0,70	1,50	0,90	1,70	1,10	1,90	1,30

CGA -350.5 P (F1max = 1000 Kg)										
	L=2,5 m		L=3 m		L=3,5 m		L=4 m		L=4,5 m	
Weight (Kg)	FA (m)	I (m)	FA (m)	I (m)	FA (m)	I (m)	FA (m)	I (m)	FA (m)	I (m)
100	0,90	0,20	1,00	0,30	1,00	0,40	2,00	1,30	1,20	0,50
125	1,00	0,30	1,10	0,40	1,10	0,40	2,20	1,50	1,30	0,60
150	1,10	0,40	1,10	0,40	1,20	0,50	2,30	1,60	1,40	0,70
175	1,10	0,40	1,20	0,50	1,30	0,60	2,60	1,90	1,50	0,80
200	1,20	0,50	1,30	0,60	1,40	0,70	2,80	2,10	1,60	0,90
225	1,30	0,60	1,40	0,70	1,50	0,80	3,00	2,30	1,70	1,00
250	1,30	0,60	1,40	0,80	1,60	0,90	3,30	2,60	1,80	1,20
275	1,40	0,70	1,50	0,80	1,70	1,00	3,50	2,80	2,00	1,30
300	1,50	0,80	1,60	1,00	1,80	1,10	3,90	3,20	2,10	1,50



Per maggiori informazioni consultare il configuratore online
For further information please use our online configurator

= LOTTO MINIMO Su richiesta / On request MINIMUM QUANTITY



CGS-250.8 MINI PICCOLO GRANDE

CARATTERISTICHE

FEATURES

- Corpo multi-forma brevettato
- Cuscinetti silenziosi di nuova generazione schermati per una migliore protezione dalla polvere; adatti a temperature che vanno dai -30° ai +80°
- Autobilanciato
- 8 ruote di supporto per ogni carrello
- Allineamento longitudinale su 16 ruote
- Perno centrale di rotazione

- Patented multiplate body
- Noiseless bearings of new generation shielded to protect against dust suitable for temperatures from -30 ° C to + 80 ° C
- Self-balancing
- 8 support wheels for each carriage
- Longitudinal alignment on 16 wheels
- Central rotation stiffened pin

MULTIPLATE BODY

2RS BEARINGS DOUBLE



- Carrello auto portante 8 ruote per cancelli a sbalzo
- 8 wheels cantilever carriage for gates
- Chariot autoportant 8 roues pour portails
- 8-rädriger Laufwagen für freitragende Tore

CGS-250.8M

CGS-250.8M	950 Kg	CGS-245M	4 x CGS-348 M16	zinc	1	5,0
Categoria commerciale: 1Q						
130,405						

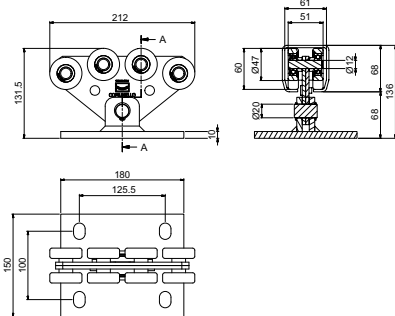

- Carrello auto portante 8 ruote per cancelli a sbalzo
- 8 wheels cantilever carriage for gates
- Chariot autoportant 8 roues pour portails
- 8-rädriger Laufwagen für freitragende Tore

CGS-250.8P

CGS-250.8P	1550 Kg	CGS-245P	6 x CGS-348 M16	zinc	1	11,8
Categoria commerciale: 1Q						
227,455						

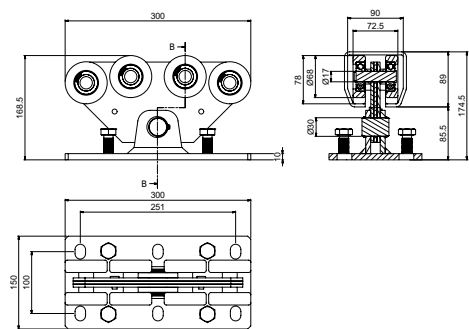

- Carrello auto portante 8 ruote per cancelli a sbalzo
- 8 wheels cantilever carriage for gates
- Chariot autoportant 8 roues pour portails
- 8-rädriger Laufwagen für freitragende Tore

CGS-250.8G

CGS-250.8G	2500 Kg	CGS-245G	6 x CGS-348 M20	zinc	1	40,0
Categoria commerciale: 1Q						
454,920						

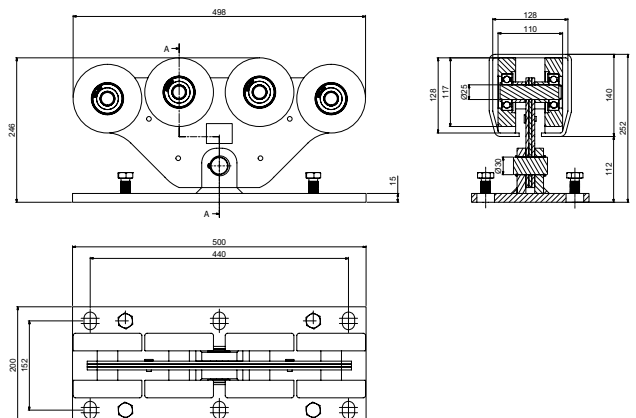

CGS-245 MINI PICCOLO GRANDE

- Monorotaia per cancelli auto-portanti
- Monorail for cantilever gates
- Rails pour portails autoportants
- Einfachschiene für selbsttragende Tore

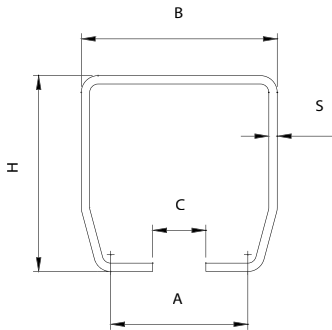

GREZZA

			L	B	H	S			€	
	CGS-245M	Mini	Raw	3000	68	68	3,5	1	18,3	97,050
	CGS-245M	Mini	Raw	6000	68	68	3,5	1	36,5	192,583
	CGS-245P	Piccolo	Raw	3000	100	89	5	1	35,0	172,865
	CGS-245P	Piccolo	Raw	6000	100	89	5	1	70,0	342,705
NEW	CGS-245P	Piccolo	Raw	9000	100	89	5	1	105,0	514,040
	CGS-245G	Grande	Raw	3000	140	140	6	1	67,0	348,765
	CGS-245G	Grande	Raw	6000	140	140	6	1	134,0	697,540

ZINCATA

	CGS-245M	Mini	Zinc	3000	68	68	3,5	1	18,3	103,110
	CGS-245M	Mini	Zinc	6000	68	68	3,5	1	36,5	201,677
	CGS-245P	Piccolo	Zinc	3000	100	89	5	1	35,0	197,135
	CGS-245P	Piccolo	Zinc	6000	100	89	5	1	71,0	376,060
NEW	CGS-245P	Piccolo	Zinc	9000	100	89	5	1	105,0	564,090
	CGS-245G	Grande	Zinc	3000	140	140	6	1	67,0	379,095
	CGS-245G	Grande	Zinc	6000	140	140	6	1	134,0	743,035

Categoria commerciale: 1R

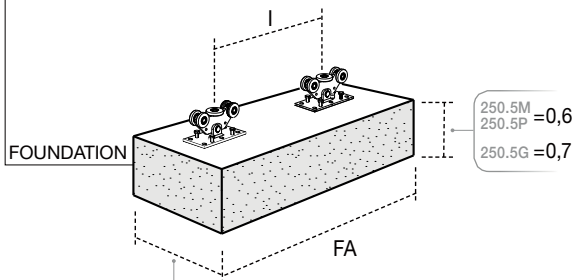
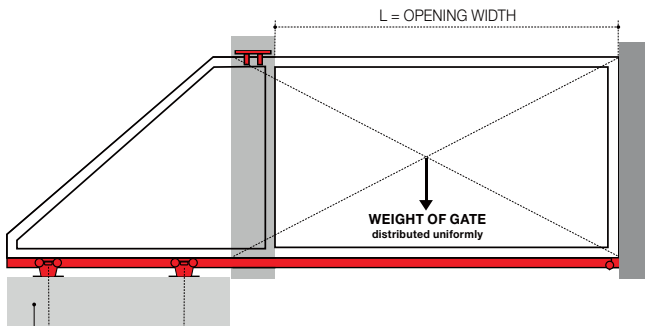

250.5M
250.5P = 0,6
250.5G = 0,8

250.5M
250.5P = 0,6
250.5G = 0,7

CGS-250.8 M (F1max = 950 Kg)

Weight (Kg)	L=2 m		L=2,5 m		L=3 m		L=3,5 m	
	FA (M)	I (M)	FA (M)	I (M)	FA (M)	I (M)	FA (M)	I (M)
200	1,10	0,50	1,20	0,60	1,30	0,70	1,50	0,90
250	1,30	0,70	1,40	0,80	1,50	0,90	1,80	1,20
300	1,50	0,90	1,60	1,00	1,80	1,20	2,10	1,50
350	1,70	1,10	1,90	1,30	2,10	1,50	2,50	1,90

CGS-250.8 P (F1max = 1550 Kg)

Weight (Kg)	L=2,5 m		L=3 m		L=3,5 m		L=4 m		L=4,5 m	
	FA (M)	I (M)	FA (M)	I (M)	FA (M)	I (M)	FA (M)	I (M)	FA (M)	I (M)
400	1,40	0,70	1,50	0,90	1,70	1,00	1,80	1,10	1,90	1,20
450	1,60	0,90	1,70	1,00	1,80	1,10	2,00	1,30	2,10	1,40
500	1,70	1,00	1,80	1,20	2,00	1,30	2,20	1,50	2,30	1,60
550	1,80	1,10	2,00	1,30	2,20	1,50	2,40	1,70	2,60	1,90
600	2,00	1,30	2,20	1,50	2,40	1,70	2,60	1,90	2,90	2,20

CGS-250.5G (F1max = 2500 Kg)

Weight (Kg)	L=5 m		L=5,5 m		L=6 m		L=6,5 m		L=7 m	
	FA (M)	I (M)	FA (M)	I (M)	FA (M)	I (M)	FA (M)	I (M)	FA (M)	I (M)
500	1,90	1,00	2,00	1,10	2,10	1,20	2,30	1,40	2,40	1,50
550	2,00	1,10	2,10	1,20	2,30	1,40	2,40	1,50	2,50	1,60
600	2,10	1,20	2,30	1,40	2,40	1,50	2,60	1,70	2,70	1,80
650	2,30	1,40	2,40	1,50	2,60	1,70	2,70	1,80	2,90	2,00



Per maggiori informazioni consultare il configuratore online
For further information please use our online configurator

= LOTTO MINIMO Su richiesta / On request MINIMUM QUANTITY



CGS-350.8 MINI PICCOLO GRANDE

CARATTERISTICHE

FEATURES

- Corpo monoblocco che assicura resistenza alla struttura
- Indicato per i climi più umidi in quanto evita la corrosione del carrello
- I cuscinetti di nuova generazione schermati e silenziosi proteggono i carrelli dalla polvere; adatti a temperature che vanno dai -30° ai +80°.
- Autobilanciato
- 8 ruote di supporto per ogni carrello
- Allineamento longitudinale su 16 ruote
- Perno centrale di rotazione

- Monoblock body that ensure strenght to the structure
- Suitable to the humid climate to avoid the carriage corrosion
- Noiseless bearings of new generation shielded to protect against dust suitable for temperatures from -30 ° C to + 80 ° C
- Self-balancing
- 8 support wheels for each carriage
- Longitudinal alignment on 16 wheels
- Central rotation pin



- Carrello auto portante 8 ruote per cancelli a sbalzo
- 8 wheels cantilever carriage for gates
- Chariot autoportant 8 roues pour portails
- 8-rädrieger Laufwagen für freitragende Tore

CGS-350.8M

CGS-350.8M	1200 Kg	CGS-345M	4 x CGS-348 M16	zinc	1	6,5	207,748	
Categoria commerciale: 1Q								

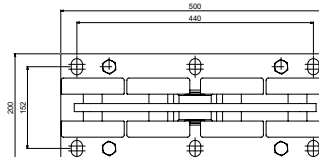
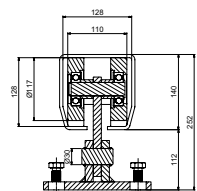
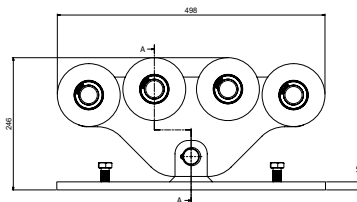
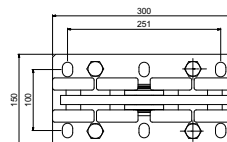
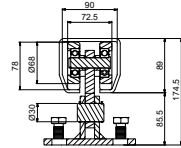
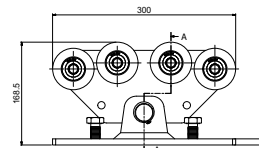
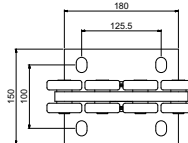
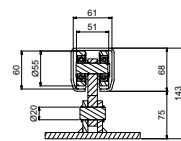
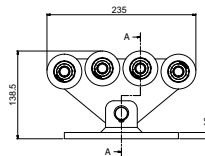

- Carrello auto portante 8 ruote per cancelli a sbalzo
- 8 wheels cantilever carriage for gates
- Chariot autoportant 8 roues pour portails
- 8-rädrieger Laufwagen für freitragende Tore

CGS-350.8P

CGS-350.8P	2000 Kg	CGS-345P	6 x CGS-348 M16	zinc	1	12,0	241,102	
Categoria commerciale: 1Q								

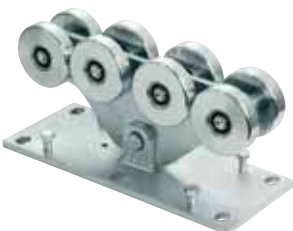

- Carrello auto portante 8 ruote per cancelli a sbalzo
- 8 wheels cantilever carriage for gates
- Chariot autoportant 8 roues pour portails
- 8-rädrieger Laufwagen für freitragende Tore

CGS-350.8G

CGS-350.8G	4000 Kg	CGS-345G	6 x CGS-348 M20	zinc	1	44,0	485,240	
Categoria commerciale: 1Q								

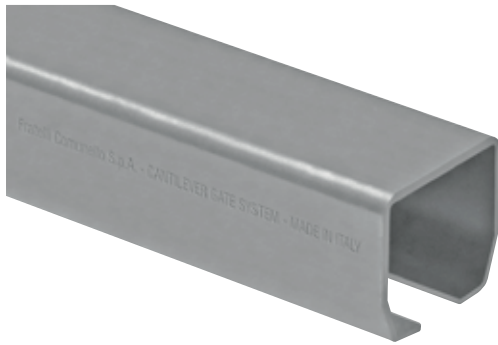

- Monorotaia per cancelli auto-portanti
- Monorail for cantilever gates
- Rails pour portails autoportants
- Einfachschiene für selbsttragende Tore

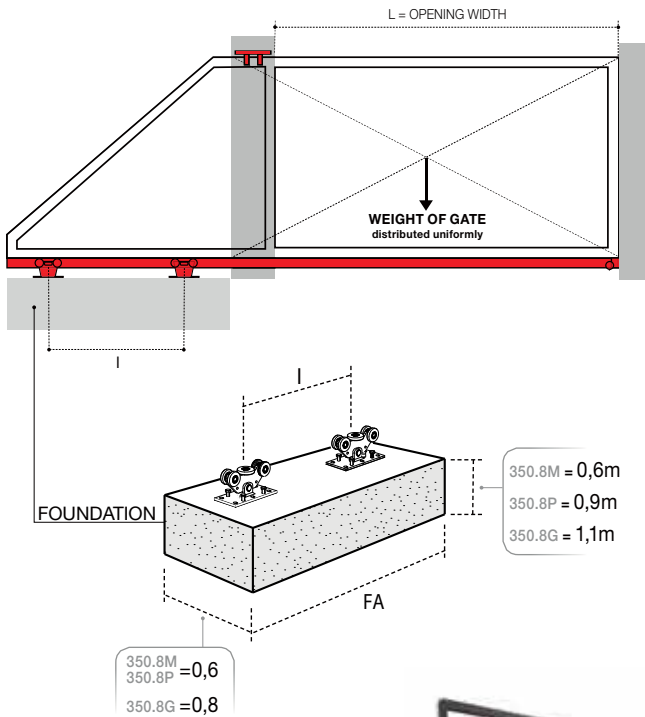
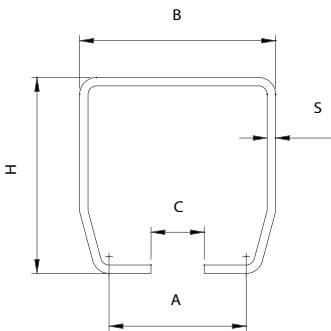

Per maggiori informazioni consultare il configuratore online
For further information please use our online configurator

CGS-345 MINI PICCOLO GRANDE

			L	B	H	S			€	
GREZZA	CGS-345M	Mini	Raw	3000	68	68	3,5	1	18,3	97,050
	CGS-345M	Mini	Raw	6000	68	68	3,5	1	36,5	194,100
	CGS-345P	Piccolo	Raw	3000	100	89	5	1	35,0	175,900
	CGS-345P	Piccolo	Raw	6000	100	89	5	1	70,0	351,800
	NEW CGS-345P	Piccolo	Raw	9000	100	89	5	1	105,0	527,700
	CGS-345G	Grande	Raw	3000	140	140	6	1	67,0	405,425
CGS-345G	Grande	Raw	6000	140	140	6	1	134,0	758,189	
ZINCATA	CGS-345M	Mini	zinc	3000	68	68	3,5	1	18,3	103,110
	CGS-345M	Mini	zinc	6000	68	68	3,5	1	36,5	200,160
	CGS-345P	Piccolo	zinc	3000	100	89	5	1	35,0	212,290
	CGS-345P	Piccolo	zinc	6000	100	89	5	1	70,0	439,755
	NEW CGS-345P	Piccolo	zinc	9000	100	89	5	1	105,0	659,630
	CGS-345G	Grande	zinc	3000	140	140	6	1	67,0	470,085
CGS-345G	Grande	zinc	6000	140	140	6	1	134,0	879,510	

Categoria commerciale: 1R

CGS-350.8 M (F1max = 1200 Kg)										
	L=3 m		L=4 m		L=5 m		L=6 m		L=7 m	
Weight (Kg)	FA (m)	I (m)	FA (m)	I (m)	FA (m)	I (m)	FA (m)	I (m)	FA (m)	I (m)
100	1,10	0,20	1,20	0,30	1,20	0,30	1,30	0,40	1,40	0,50
150	1,20	0,30	1,30	0,40	1,40	0,50	1,50	0,60	1,60	0,70
200	1,30	0,40	1,40	0,50	1,60	0,70	1,70	0,80	1,90	1,00
250	1,40	0,50	1,60	0,70	1,80	0,90	1,90	1,00	2,10	1,20
300	1,50	0,60	1,70	0,90	2,00	1,10	2,20	1,30	2,40	1,50
350	1,70	0,80	1,90	1,00	2,20	1,30	2,50	1,60	2,80	1,90
400	1,90	1,00	2,20	1,30	2,50	1,60	2,80	1,90	3,10	2,20
450	2,00	1,10	2,40	1,50	2,80	1,90	3,20	2,30	3,60	2,70
500	2,30	1,40	2,70	1,80	3,10	2,20	3,60	2,70	4,10	3,20

CGS-350.8 P (F1max = 2000 Kg)										
	L=4 m		L=5 m		L=6 m		L=7 m		L=8 m	
Weight (Kg)	FA (m)	I (m)	FA (m)	I (m)	FA (m)	I (m)	FA (m)	I (m)	FA (m)	I (m)
400	1,40	0,70	1,60	0,90	1,70	1,00	1,90	1,20	2,10	1,40
450	1,50	0,80	1,70	1,00	1,90	1,20	2,10	1,40	2,30	1,60
500	1,60	0,90	1,80	1,10	2,10	1,40	2,30	1,60	2,60	1,90
550	1,70	1,00	2,00	1,30	2,20	1,50	2,50	1,80	2,80	2,10
600	1,80	1,10	2,10	1,40	2,40	1,70	2,70	2,00	3,00	2,40
650	2,00	1,30	2,30	1,60	2,60	1,90	3,00	2,30	3,30	2,60
700	2,10	1,40	2,50	1,80	2,80	2,10	3,20	2,50	3,60	2,90
750	2,30	1,60	2,70	2,00	3,10	2,40	3,50	2,80	3,90	3,30
800	2,40	1,80	2,90	2,20	3,30	2,60	3,80	3,10	4,30	3,60

CGS-350.8 G (F1max = 4000 Kg)										
	L=8 m		L=10 m		L=12 m		L=14 m		L=16 m	
Weight (Kg)	FA (m)	I (m)	FA (m)	I (m)	FA (m)	I (m)	FA (m)	I (m)	FA (m)	I (m)
800	2,40	1,50	2,80	1,90	3,30	2,40	3,80	2,90	4,40	3,50
850	2,50	1,60	2,90	2,00	3,40	2,50	4,00	3,10	4,60	3,70
900	2,60	1,70	3,10	2,20	3,60	2,70	4,20	3,30	4,90	4,00
950	2,70	1,80	3,20	2,30	3,80	2,90	4,40	3,50	5,10	4,20
1000	2,80	1,90	3,30	2,50	4,00	3,10	4,60	3,70	5,30	4,40
1050	2,90	2,00	3,50	2,60	4,10	3,20	4,80	3,90	5,60	4,70
1100	3,00	2,10	3,70	2,80	4,30	3,40	5,10	4,20	5,90	5,00
1150	3,20	2,30	3,80	2,90	4,50	3,60	5,30	4,40	6,20	5,30
1200	3,30	2,40	4,00	3,10	4,70	3,80	5,60	4,70	6,50	5,60

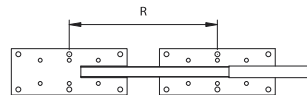

- **Contro piastra per carrelli piccolo e grande**
- Counter plate for carriages - small and large
- Contre-plaque pour chariots - petit e grand
- Gegenplatte für Laufwagen gross und klein

CG-05

CG-05P	Piccolo	zinc	2	2,7	34,872
CG-05G	Grande	zinc	2	6,0	59,143

Categoria commerciale: 1T



- **Dima di allineamento ancoranti e fissaggio carrelli**
- Alignment tie rods template and fixture of the carriages
- Calibre d'alignement des tirants et fixation chariots
- Lehre für die Aufreihung der Gewindestangen und für die Laufwagenbefestigung

CG-10

CG-10	500-5400	zinc	1	20,0	181,970

Categoria commerciale: 1T

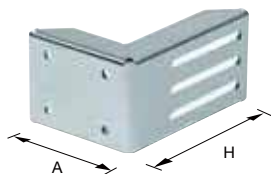

- **Staffa angolare regolabile fissaggio a muro per incontro**
- Adjustable wall mounting angle racket for end cup
- Platine angulaire réglable fixation au mur pour butée
- Verstellbare Eckmauerhalterung für Auflageschuh

CG-15

	A	H					
CG-15M	155	165	Mini	zinc	1	2,6	42,460
CG-15P	155	190	Piccolo	zinc	1	2,9	48,520
CG-15G	155	220	Grande	zinc	1	3,3	54,590

Categoria commerciale: 1T

ART. CG-20M / CG-20P



- **Terminale senza ruota per monorotaia**
- End stopper without wheel for monorail
- Embout d'extrémité sans galet pour rail
- Endpfropfen für Einfachschiene ohne Rad

ART. CG-20G

CG-20



CG-20M	Mini	zinc	2	1,6	25,777
CG-20P	Piccolo	zinc	2	2,3	33,365
CG-20G	Grande	zinc	2	3,9	39,425
NEW CG-20XL	XL	zinc	1	3,7	59,471

Categoria commerciale: 1T



- **Terminale per monorotaia in alluminio**
- End stopper for aluminium monorail
- Embout d'extrémité pour rail en aluminium
- Endpfropfen für Einfachschiene aus Aluminium

CGA-20

CGA-20M	Mini	zinc	2	0,44	9,095
CGA-20P	Piccolo	zinc	2	0,52	12,130

Categoria commerciale: 1T

NEW

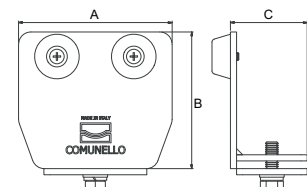

- **Terminale senza ruota per monorotaia**
- End stopper without wheel for monorail
- Embout d'extrémité sans galet pour rail
- Endpfropfen für Einfachschiene ohne Rad

CG-21

		A	B	C				
CG-21 M	Mini	68	68	49	zinc	4	1,30	11,04
CG-21 P	Piccolo	100	89	50	zinc	4	1,70	14,193
CG-21 G	Grande	140	140	53	zinc	4	4,90	17,348

Categoria commerciale: 1T

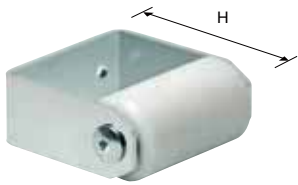

- Incontro inferiore con rullo in nylon
- Lower end cup with nylon roller
- Butée inférieure avec rouleau en nylon
- Unterauflegesohuh mit Nylonrolle

CG-25



Icon	Icon	Icon	Icon	Icon	Icon	Icon
CG-25M	Mini	zinc	2	1,6	40,943	
CG-25P	Piccolo	zinc	2	2,5	47,013	
CG-25G	Grande	zinc	2	4,9	56,108	

Categoria commerciale: 1T



- Incontro per cancelli regolabile a fissare
- Adjustable end cup to be fixed for gates
- Butée réglable à fixer pour portails
- Verstellbarer Auflegesohuh zum Aufschrauben für Tore

CG-30

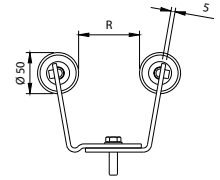

Icon	Icon	Icon	Icon	Icon	Icon	Icon
CG-30M	Mini	zinc	53-76	1	1,5	60,660
CG-30P	Piccolo	zinc	86-114	1	1,9	71,273
CG-30G	Grande	zinc	103-150	1	2,2	77,332

Categoria commerciale: 1S



- Supporto intermedio di sostegno con rullo in nylon
- Intermediate support with nylon roller
- Support intermédiaire de soutien avec rouleau en nylon
- Mittlerer Stütze für selbsttragende Tore

CG-35



Icon	Icon	Icon	Icon	Icon	Icon	Icon
CG-35P	Piccolo	zinc	95	1	1,4	60,660
CG-35G	Grande	zinc	120	1	3,1	97,050

Categoria commerciale: 1T

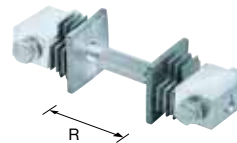

- Tirante in acciaio zincato per regolazioni cancelli
- Tension bar for gate regulation
- Tirants pour réglage portails
- Ankerbolzen zur Torregulierung

CG-40

Icon	Icon	Icon	Icon	Icon	Icon	Icon
CG-40	zinc	50-100	1	1,3	48,520	

Categoria commerciale: 1T

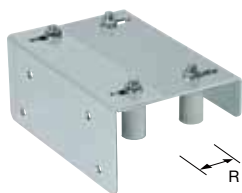

- Piastra guida cancello regolabile con ala lunga a fissare
- Adjustable gate guide to be fixed with long side plate
- Plaque guide portail réglable à fixer avec aile longue
- Verstellbare Torführungsplatte mit langem Flügel zum Aufschrauben

CG-251

Icon	Icon	Icon	Icon	Icon	Icon	Icon
CG-251	L=350 Ø40	zinc	70-110	1	6,7	75,815

Categoria commerciale: 1S



- Supporto anti deragliamento regolabile per art. CG-254
- Adjustable support against derailment for art. CG-254
- Support réglable anti-déraillement pour art. CG-354
- Verstellbares Lager gegen Entgleisung für CG-354

CG-252

Icon	Icon	Icon	Icon	Icon	Icon	Icon
CG-252	Ø 40	zinc	167	2	1,9	30,330

Categoria commerciale: 1S

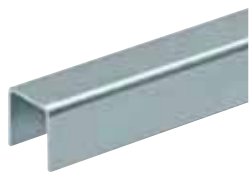

- Canalina a "U" per supporto anti deragliamento
- U channel for supports against derailment
- Caniveau à U pour supports anti-déraillement
- U-Einfachschiene für Stütze gegen Entgleisung

CG-254

CG-254	L=3000	zinc	1	13,0	94,015

Categoria commerciale: 1S



- Rullo in gomma guida cancello
- Rubber roller for guiding gate
- Rouleau en caoutchouc guide-portail
- Torführungsrolle aus Schwarz Gummi

CG-256

CG-256-40	zinc	2	0,8	45,495	
CG-256-50	zinc	2	1,7	51,555	

Categoria commerciale: 1S



- Ancorante filettato per carrelli CGS 350 e CGS 350.8
- Threaded tie rods for carriages CGS 350 and CGS 350.8
- Tirant fileté pour chariots CGS 350 et CGS 350.8
- Gewindestange für Laufwagen CGS 350 e CGS 350.8

CG-348

CG-348	M16	zinc	12	8,3	10,612
CG-348	M20	zinc	12	13,2	15,165

Categoria commerciale: 1T



- Ruota terminale in nylon per monorotaia in alluminio
- Nylon end wheel for aluminium monorail
- Galet d'extrémité en nylon pour rail en aluminium
- Nylon-Endrolle für Einfachschiene aus Aluminium

CGA-347

CGA-347M	Mini	zinc	2	2,1	34,872
CGA-347P	Piccolo	zinc	2	3,4	42,460

Categoria commerciale: 1T



- Incontro inferiore a fissare
- Bottom end cup to be fixed
- Butée inférieure à fixer
- Unterauflageschuh zum Aufschrauben

CGS-346

XL G P M

CGS-346M	Mini	zinc	2	2,1	18,200
CGS-346P	Piccolo	zinc	2	3,3	21,225
CGS-346G	Grande	zinc	2	7,4	36,390
NEW CGS-346XL	XL	zinc	1	4,8	59,301

Categoria commerciale: 1T



- Ruota terminale per monorotaia
- End wheel for monorail
- Galet d'extrémité pour rail
- Endrad für Einfachschiene

CGS-347

XL G P M

CGS-347M	Mini	zinc	terminale in nylon	2	2,1	37,907
CGS-347P	Piccolo	zinc		2	3,4	47,013
CGS-347G	Grande	zinc		2	8,4	80,367
NEW CGS-347XL	XL	zinc		1	7,1	106,989

Categoria commerciale: 1T

KIT GATE

SEMPLICE
EASY

SICURO
SAFE

AFFIDABILE
RELIABLE

150 - 300K

CGA 150 - 300K

150 - 600K

CGA 150 - 600K



Soluzioni semplici e sicure per cancelli residenziali autoportanti
Reliable solutions for all kinds of residential cantilever gate

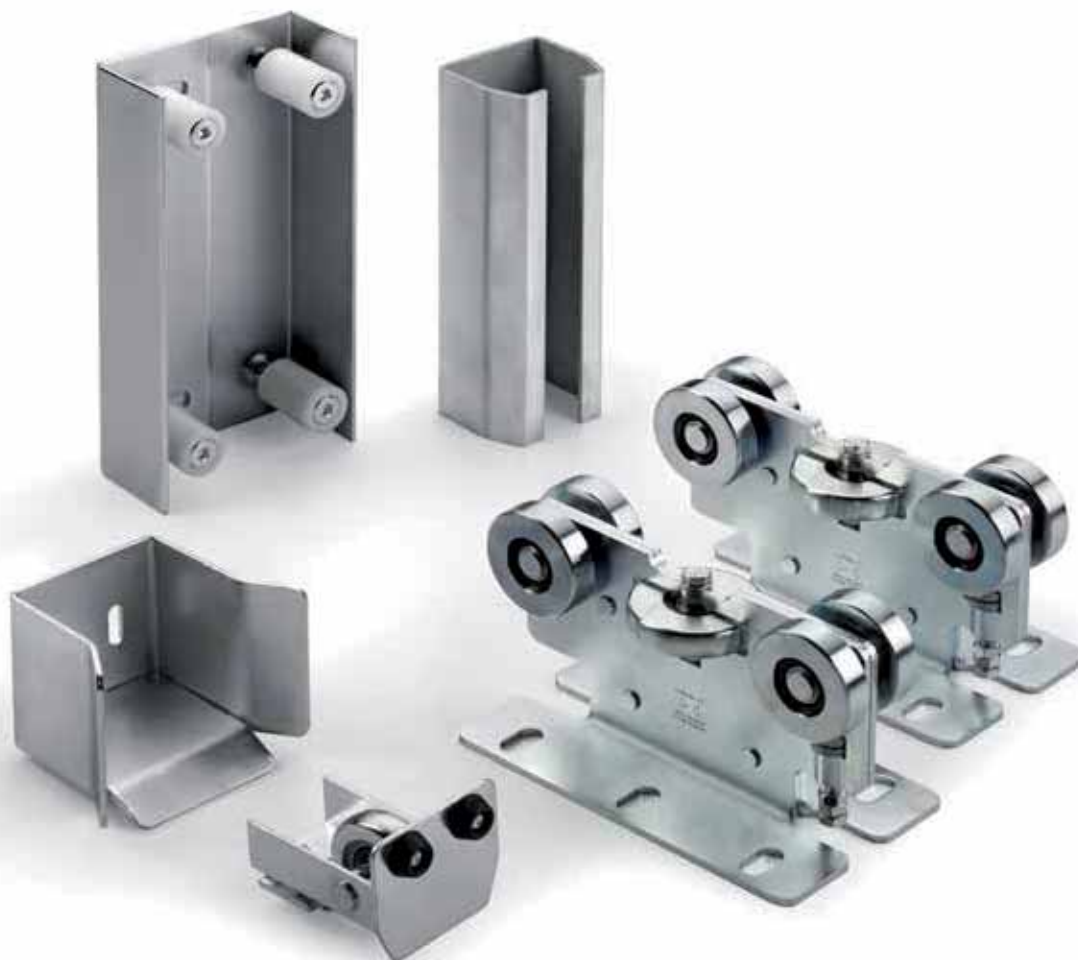

KIT 150-300K

- Kit per cancelli autoportanti fino a 300Kg di peso
- Kit for cantilever gates, weight up to 300 kg
- Kit pour portails autoportants jusqu'à 300 kilos de poids
- Kit für selbsttragende Tore mit Gewicht bis 300 kg

PATENTED

KIT CGS 150-300K BASIC 3M	zinc	1	47,30	448,850
KIT CGS 150-300K BASIC 6M	zinc	1	46,80	448,850
KIT CGS 150-300K TOP 3M	zinc	1	48,30	460,980
KIT CGS 150-300K TOP 6M	zinc	1	48,30	460,980

Categoria commerciale: 1U

KIT 150-600K

- Kit per cancelli autoportanti fino a 600Kg di peso
- Kit for cantilever gates, weight up to 600 kg
- Kit pour portails autoportants jusqu'à 600 kilos de poids
- Kit für selbsttragende Tore mit Gewicht bis 600 kg

PATENTED

KIT CGS 150-600K BASIC 3M	zinc	1	127,74	955,325
KIT CGS 150-600K BASIC 6M	zinc	1	163,17	1.116,060
KIT CGS 150-600K TOP 3M	zinc	1	132,44	985,655
KIT CGS 150-600K TOP 6M	zinc	1	168,00	1.143,355

Categoria commerciale: 1U



KIT CGA 150-300K

- Kit per cancelli autoportanti fino a 300Kg di peso
- Kit for cantilever gates, weight up to 300 kg
- Kit pour portails autoportants jusqu'à 300 kilos de poids
- Kit für selbsttragende Tore mit Gewicht bis 300 kg

PATENTED

KIT CGA 150-300K 3M	zinc	1	8,5	272,950

Categoria commerciale: 1U

KIT CGA 150-600K

- Kit per cancelli autoportanti fino a 600Kg di peso
- Kit for cantilever gates, weight up to 600 kg
- Kit pour portails autoportants jusqu'à 600 kilos de poids
- Kit für selbsttragende Tore mit Gewicht bis 600 kg

PATENTED

KIT CGA 150-600K 6M	zinc	1	16,2	333,610

Categoria commerciale: 1U



☐ 150 - 300K

☐ 150 - 600K

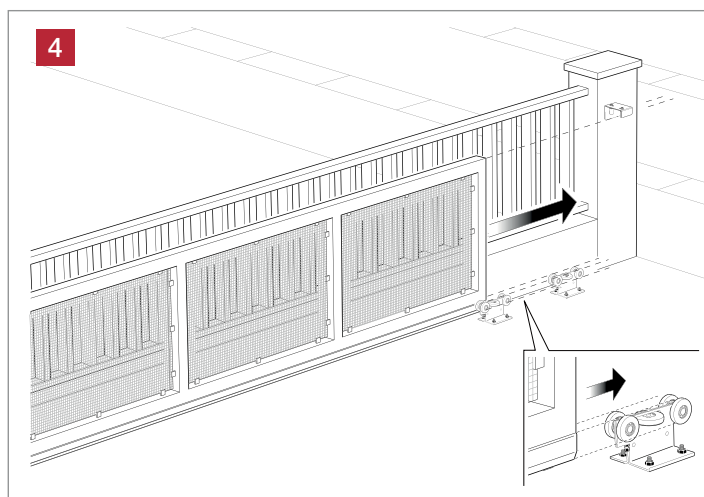
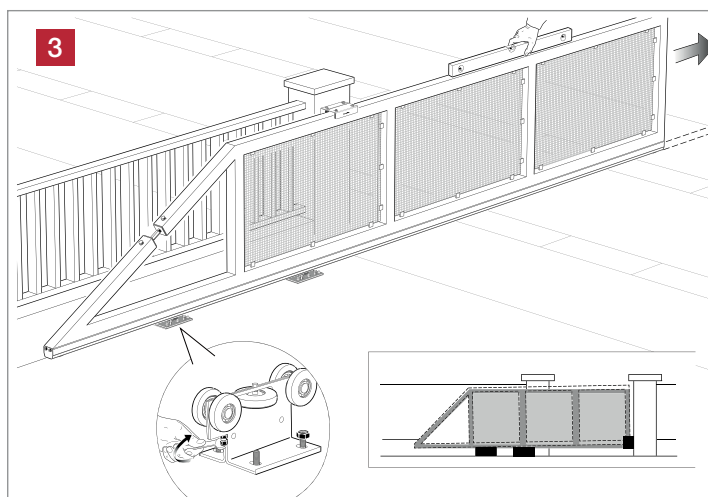
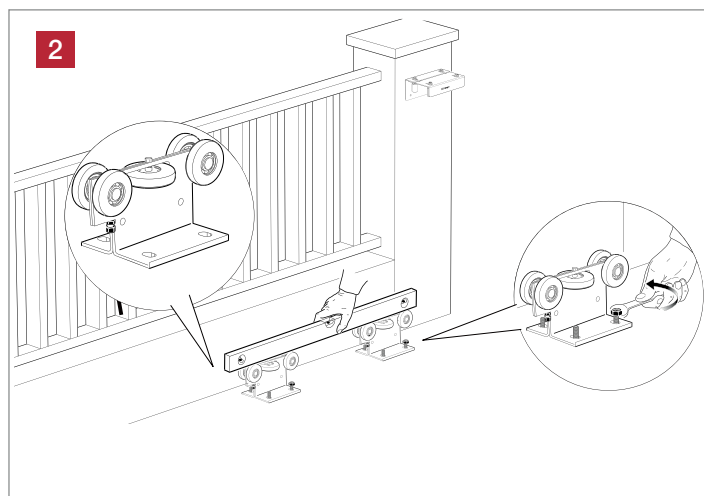
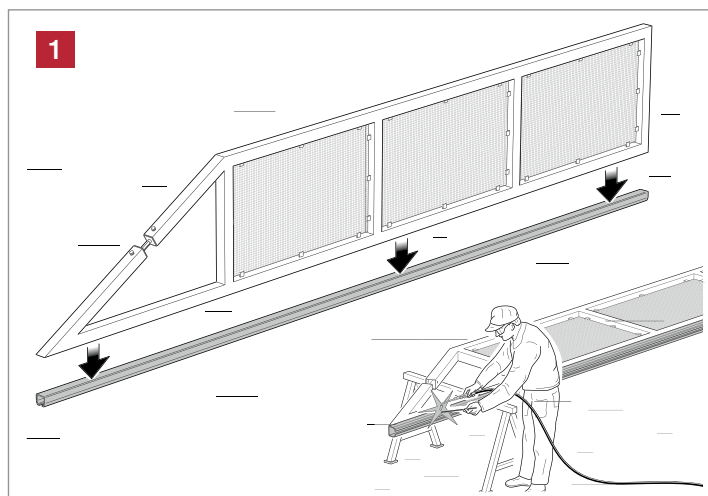

KIT 150-300K

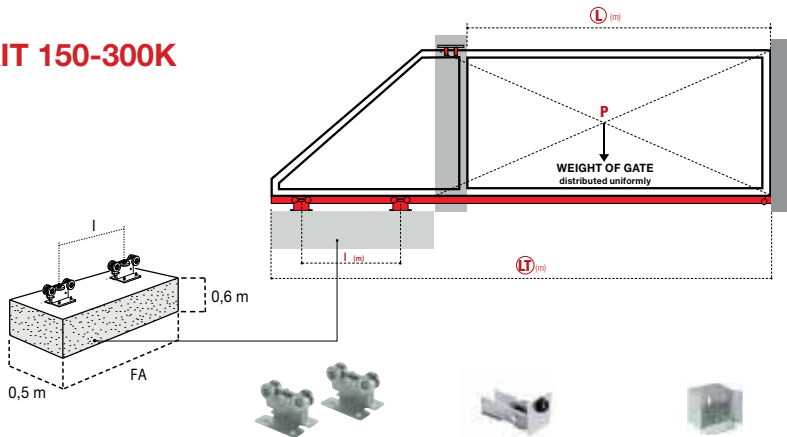

CGS-150.5 M Capacity = 700 kg						
P	L=2 m		L=2,5 m		L=3 m	
WEIGHT OF GATE (Kg)	FA (m)	I (m)	FA (m)	I (m)	FA (m)	I (m)
100	0,9	0,3	1,0	0,4	1,0	0,4
125	1,0	0,4	1,0	0,4	1,1	0,5
150	1,0	0,4	1,1	0,5	1,2	0,6
200	1,2	0,6	1,3	0,7	1,4	0,8
250	1,4	0,8	1,5	0,9	1,7	1,1
300	1,6	1,4	1,8	1,3	2,1	1,5

ORDER CODE	CGS 150.5M	CGS 347M	CGS 346M	230	255	CGS 245M
KIT 150-300K TOP 6M	2 mini	1	1		1 (220 / Ø30)	1 (6 m)
KIT 150-300K TOP 3M	2 mini	1	1		1 (220 / Ø30)	2 (3 m)



ORDER CODE	CGS 150.5M	CGS 347M	CGS 346M	230	CGS 245M
KIT 150-300K BASIC 6M	2 mini	1	1	4 x Ø30	1 (6 m)
KIT 150-300K BASIC 3M	2 mini	1	1	4 x Ø30	2 (3 m)

KIT 150-600K

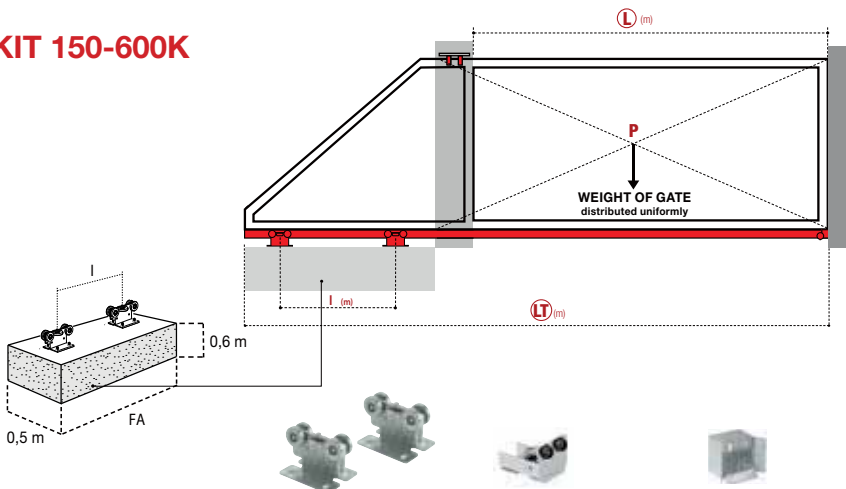

CGS-150.5 P Capacity = 1300 kg						
P	L= 4 m		L= 5 m		L= 6 m	
WEIGHT OF GATE (Kg)	FA (m)	I (m)	FA (m)	I (m)	FA (m)	I (m)
350	1,8	1,1	2,1	1,4	2,4	1,7
400	2,0	1,3	2,3	1,6	2,7	2,0
450	2,2	1,5	2,6	1,9	3,1	2,4
500	2,5	1,8	3,0	2,3	3,5	2,8
550	2,8	2,1	3,3	2,6	3,9	3,2
600	3,2	2,5	3,8	3,1	4,5	3,8

ORDER CODE	CGS 150.5P	CGS 347P	CGS 346P	255	CGS 245P
KIT 150-600K TOP 6M	2 piccolo	1	1	1 (350 / Ø40)	2 (6 m)
KIT 150-600K TOP 3M	2 piccolo	1	1	1 (350 / Ø40)	3 (3 m)



ORDER CODE	CGS 150.5P	CGS 347P	CGS 346P	230	CGS 245P
KIT 150-600K BASIC 6M	2 piccolo	1	1	4 x Ø40	2 (6 m)
KIT 150-600K BASIC 3M	2 piccolo	1	1	4 x Ø40	3 (3 m)



☐ CGA 150 - 300K

☐ CGA 150 - 600K

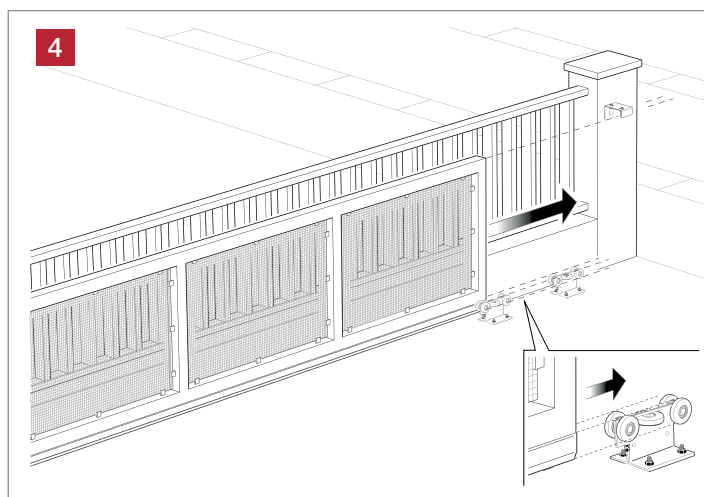
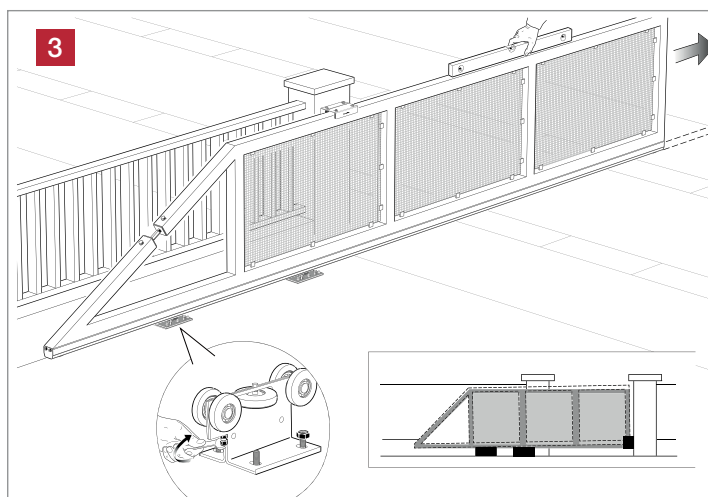
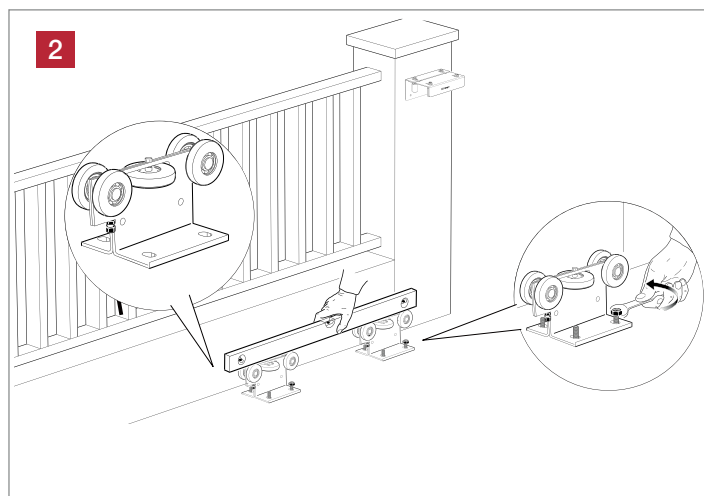
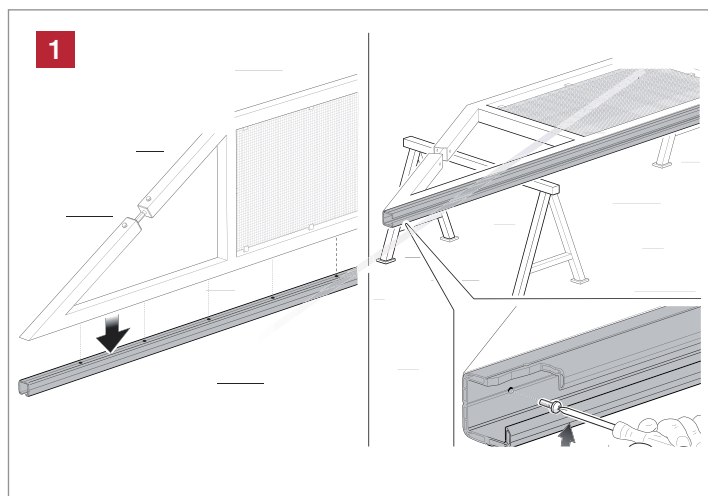

KIT CGA 150-300K

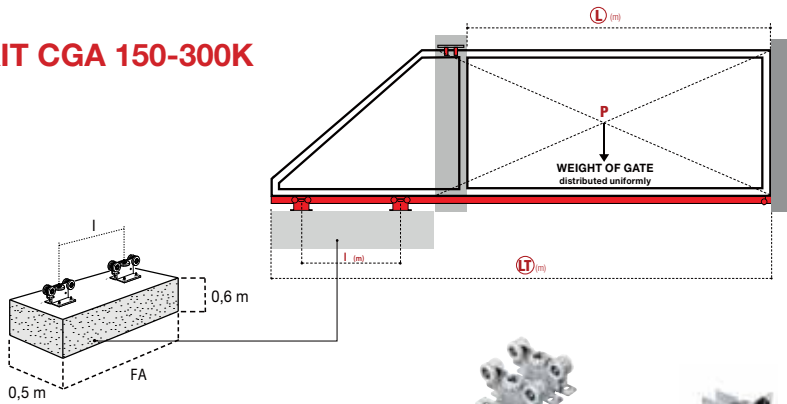

CGA-150.5 M Capacity = 700 kg						
P	L=2 m		L=2,5 m		L=3 m	
WEIGHT OF GATE (Kg)	FA (m)	I (m)	FA (m)	I (m)	FA (m)	I (m)
100	0,9	0,3	1,0	0,4	1,0	0,4
125	1,0	0,4	1,0	0,4	1,1	0,5
150	1,0	0,4	1,1	0,5	1,2	0,6
200	1,2	0,6	1,3	0,7	1,4	0,8
250	1,4	0,8	1,5	0,9	1,7	1,1
300	1,6	1,4	1,8	1,3	2,1	1,5

ORDER CODE	CGS 150.5M	CGS 347M	CGA 346M	CGA 20M
KIT CGA 150-300K	2 mini	1	1	1

KIT CGA 150-600K

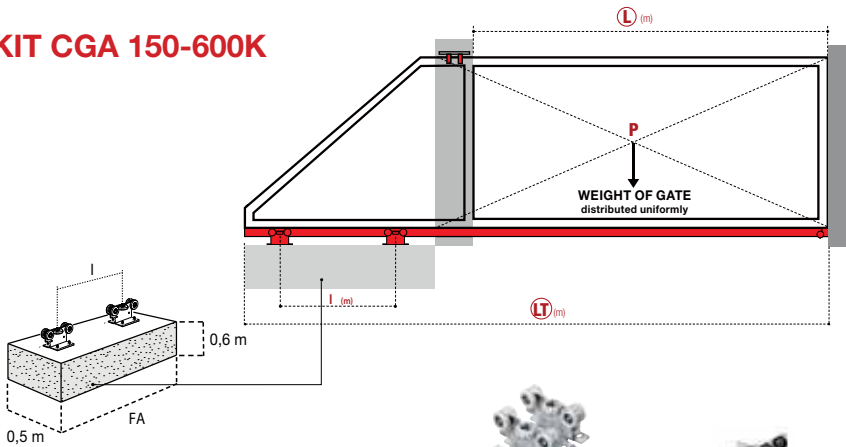

CGA-150.5 P Capacity = 1300 kg						
P	L= 4 m		L= 5 m		L= 6 m	
WEIGHT OF GATE (Kg)	FA (m)	I (m)	FA (m)	I (m)	FA (m)	I (m)
350	1,8	1,1	2,1	1,4	2,4	1,7
400	2,0	1,3	2,3	1,6	2,7	2,0
450	2,2	1,5	2,6	1,9	3,1	2,4
500	2,5	1,8	2,3	3,0	3,5	2,8
550	2,8	2,1	3,3	2,6	3,9	3,2
600	3,2	2,5	3,8	3,1	4,5	3,8

ORDER CODE	CGS 150.5P	CGS 347P	CGA 346P	CGA 20P
KIT CGA 150-600K	2 piccolo	1	1	1



- Piastra inferiore con perno sferico
- Bottom plate with spherical pin
- Platine inférieur et pivot sphérique
- Bodenplatte mit Drehstift

84i

Icon	D	Material	Capacity	Qty	Weight	Price
Icon	42x42	inox	100 Kg*	2	1,3	€ 61,206

* valore portata a coppia L/H=1 / capacity of couple hinges L/H=1

Categoria commerciale: 2A

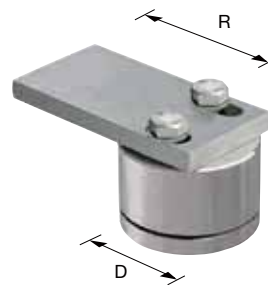

- Cardine superiore con piastra
- Upper hinge with plate
- Gond supérieur avec platine
- Oberes Torband mit Platte

86i

Icon	D	Material	Capacity	Qty	Weight	Price
Icon	Ø50	inox	200 Kg*	2	1,7	€ 90,554
Icon	Ø70	inox	650 Kg*	2	4,1	€ 125,557

* valore portata a coppia L/H=1 / capacity of couple hinges L/H=1

Cuscinetto in acciaio / steel bearing

Categoria commerciale: 2A



- Cardine inferiore con cuscinetto reggi spinta
- Bottom hinge with thrust bearing
- Gond inférieur avec roulement de butée
- Unteres Torband mit Drucklager

87i-P

Icon	D	Material	Capacity	Qty	Weight	Price
Icon	Ø50	inox	200 Kg*	2	1,0	€ 69,755
Icon	Ø70	inox	650 Kg*	2	2,0	€ 97,651

* valore portata a coppia L/H=1 / capacity of couple hinges L/H=1

Categoria commerciale: 2A



- Perno e piastra a saldare
- Pivot and plate to be welded
- Pivot et plaque à souder
- Drehstift und Platte zum Schweißen

116i

Icon	Material	Capacity	Qty	Weight	Price
Icon	inox	150 Kg*	2	1,3	€ 27,415
Icon	inox	240 Kg*	2	2,2	€ 31,586

* valore portata a coppia L/H=1 / capacity of couple hinges L/H=1

Categoria commerciale: 2A

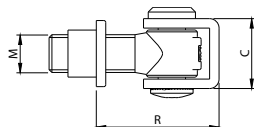

- Cardine con cavalletto e bussola
- Hinge with u-bolt and bush
- Gond avec crampillon et douille
- Torband mit U-Bügel und Buchse

120i

Icon	Material	C	M	R	Capacity	Qty	Weight	Price
Icon	inox	37	M20	45-65	150 Kg*	8	3,3	€ 36,390
Icon	inox	47	M24	53-75	225 Kg*	4	6,6	€ 57,625

* valore portata a coppia L/H=1 / capacity of couple hinges L/H=1

Categoria commerciale: 2A

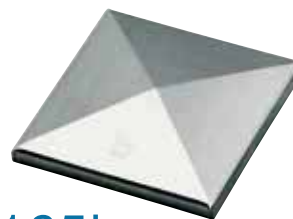

- Copri pilastrino quadrato
- Square pillar cover
- Couvre pilastre carré
- Viereckiger Pfostendeckel

165i

Icon	Material	Qty	Weight	Price
Icon	inox	10	0,3	€ 1,365
Icon	inox	10	0,4	€ 1,758
Icon	inox	10	0,6	€ 1,987
Icon	inox	10	0,7	€ 2,664
Icon	inox	6	0,7	€ 3,581
Icon	inox	6	1,1	€ 5,350
Icon	inox	6	1,4	€ 7,391
Icon	inox	2	0,8	€ 11,213

Categoria commerciale: 2G

NEW

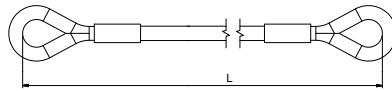

- **Sicurezza anticaduta per cancelli a battente**
- Safety cable for swinging gate anti downfall
- Cable anti chute pour portail battent
- Fall-Schutz Kabel

195i

		L	Portata con cardine superiore Capacity with top hinge			€
195i-400	inox	400	400	10	1	16,120
195i-500	inox	500	400	10	1,2	17,300
195i-600	inox	600	400	10	1,4	18,600
195i-700	inox	700	400	10	1,7	20,100

Categoria commerciale: 2G

NEW

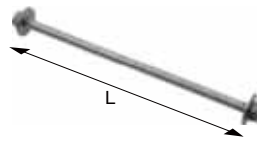

- **Barra filettata per sicurezza anticaduta**
- Bar for safety cable anti downfall
- Tige filetée pour cable anti chute
- Gewindestange für Fall-Schutz Kabel

197i

		L			€
197i	inox	250	10	1,9	9,900

Categoria commerciale: 2G



- **Battente d'arresto a cementare**
- Stop batten to be cemented
- Battent d'arrêt à sceller
- Auflaufschuh zum Ausbetonieren

170i

				€
170i	inox	5	1,80	€ 14,717

Categoria commerciale: 2G



- **Arresto di fine corsa**
- Runaway stop
- Boutoir de fin de course
- Torendpuffer

200i-G

					€
200i-G	H=115	inox	5	2,9	€ 32,612

Categoria commerciale: 2G



- **Oliva in nylon**
- Nylon roller
- Rouleau en nylon
- Nylon-Führungsrolle

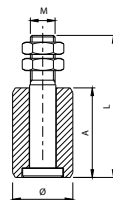

230i

			M			€
230i-30	Ø30	inox	M16	8	1,5	€ 15,176
230i-40	Ø39	inox	M16	4	1,1	€ 20,973

Categoria commerciale: 2L



- **Piastra guida cancello regolabile**
- Drive-gate adjustable plate
- Platine guide-portail réglable
- Verstellbarer Torführungsbügel

250i

			R			€
250i-220	Ø 34,5	inox	30-60	1	1,4	79.101

Categoria commerciale: 2L

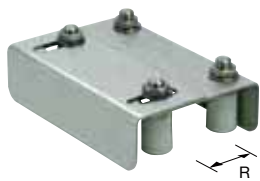

- Piastra guida cancello a doppia regolazione
- Guiding plate for gates with double adjustment
- Platine guide-portail à double réglage
- Torführungsbügel mit Doppelverstellung

255i

255i-220	Ø30	inox	35-62	1 2,3 € 118,275

Categoria commerciale: 2L

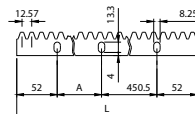
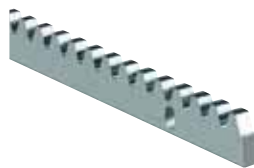

- Cremagliera Rettangolare 30x12 con fori
- Rectangular rack 30x12 with holes
- Crémaillère rectangulaire 30x12 avec trous
- Rechteckige Zahnstange 30x12 mit Bohrungen

262i

262i-30x12	L=1000	450,5	inox	1 2,4 € 181,970

Categoria commerciale: 2F



- Attacco a saldare per cremagliera rettangolare
- Support for rectangular rack to be welded
- Attache entretoise pour crémaillère rectangulaire
- Distanzstück für rechteckige Zahnstange zum Schweißen

264i

264i	inox	20	1,0	€ 8,822

Categoria commerciale: 2F



- Maniglia ad incasso
- Flush-mounted handle
- Poignée à encaisser
- Muschelgriff

270i

270i-P		52x115	inox	4 0,3 € 9,717
270i-G		90x200	inox	4 1,0 € 24,882

Categoria commerciale: 2H

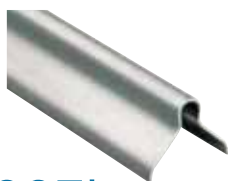

- Binario a cementare "Pendolino"
- Track to be cemented "Pendolino"
- Rail à sceller "Pendolino"
- Bodenlaufschiene zum Einbetonieren "Pendolino"

287i

287i-G-Ø19-Sp2	L=3000	inox	19	1 6,0 € 151,640
287i-G-Ø19-Sp2	L=6000	inox	19	1 11,9 € 272,950

Categoria commerciale: 2I



- Binario a fissare "Rapido"
- Track to be bolted "Rapido"
- Rail à visser "Rapido"
- Laufschiene zum Anschrauben "Rapido"

289i-G

289i-G-Ø19-Sp2	L=3000	inox	19	1 3,3 € 97,050
289i-G-Ø19-Sp2	L=6000	inox	19	1 6,2 € 166,805

Categoria commerciale: 2I



- Spina di collegamento per binario Art. 289I - Ø19
- Connection pin for track Art. 289I - Ø19
- Jonction pour rail Art. 289I - Ø19
- Verbindungsstift zum Laufschiene Art. 289I - Ø19

291i

291i	80-Ø12,5	inox	1	0,1	€ 5,634

Categoria commerciale: 2I



- Binario a fissare "Diretto"
- Track to be bolted "Diretto"
- Rail à visser "Diretto"
- Laufschiene zum Anschrauben "Diretto"

293i

293i	L=3000	inox	1	3,0	€ 87,191
293i	L=6000	inox	1	6,0	€ 313,893

Categoria commerciale: 2I



- Spina di collegamento per binario Art.293I
- Connection pin for track Art.293I
- Jonction pour rail Art.293I
- Verbindungsstift zum Art.293I

295i

295i	90-Ø8,5	inox	1	0,1	€ 1,867

Categoria commerciale: 2I



- Spina di collegamento per binario Art. 287I-G
- Connection pin for track 287I-G
- Jonction pour rail Art.287I-G
- Verbindungsstift zum Laufschiene Art. 287I-G

297i

297i	90-Ø14,00	inox	1	0,1	€ 11,508

Categoria commerciale: 2I



- Ruota gola V
- Wheel with V groove
- Galet avec gorge V
- Schiebetorrolle mit V-Rille

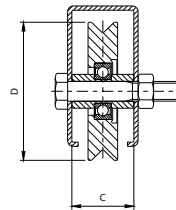

300i W

	D	C				
300I-V60	Ø 60	24	inox	100 Kg	2	0,7 € 39,425
300I-V80	Ø 78	34	inox	200 Kg	2	1,5 € 54,590
300I-V90	Ø 88	34	inox	210 Kg	2	1,8 € 59,475
300I-V100	Ø 98	34	inox	220 Kg	2	2,4 € 75,815
300I-V120	Ø 117	34	inox	240 Kg	2	3,4 € 84,920
300I-V140	Ø 137	44	inox	270 Kg	2	5,4 € 138,255
300I-V160	Ø 157	44	inox	370 Kg	2	7,1 € 174,371
300I-V200	Ø 197	44	inox	400 Kg	2	11,3 € 256,988

Categoria commerciale: 2M



- Ruota gola V
- Wheel with V groove
- Galet avec gorge V
- Schiebetorrolle mit V-Rille

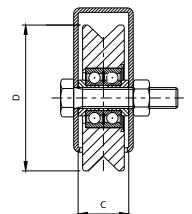

305i W

	D	C				
305I-V100	Ø98	34	inox	400 Kg	2	3,0 € 90,980
305I-V120	Ø117	34	inox	420 Kg	2	4,3 € 114,453
305I-V140	Ø137	44	inox	540 Kg	2	6,6 € 178,935
305I-V160	Ø157	44	inox	770 Kg	2	9,4 € 245,884
305I-V200	Ø197	44	inox	800 Kg	2	14,9 € 331,329

Categoria commerciale: 2M

2 CUSCINETTI
2 BEARINGS



- Ruota gola semitonda
- Wheel with half-rounded groove
- Galet avec gorge demi-ronde
- Schiebetorrolle mit Rundrille

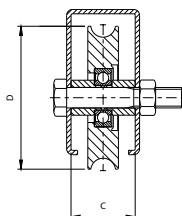

310i W

1 CUSCINETTO
1 BEARING

	D	C							€
310i-60	-	Ø 60	24	inox	100 Kg	2	0,7		€ 38,399
310i-80S	Ø19	Ø 78	34	inox	200 Kg	2	1,3		€ 48,520
310i-90S	Ø19	Ø 88	34	inox	210 Kg	2	1,8		€ 66,720
310i-100S	Ø19	Ø 98	34	inox	220 Kg	2	2,3		€ 83,588
310i-120	Ø19	Ø 117	34	inox	240 Kg	2	3,5		€ 108,951
310i-140	Ø19	Ø 137	44	inox	270 Kg	2	5,0		€ 142,764
310i-160	Ø19	Ø 157	44	inox	370 Kg	2	6,6		€ 174,371
310i-200	Ø19	Ø 197	44	inox	400 Kg	2	10,7		€ 255,165

Categoria commerciale: 2M



- Ruota gola semitonda
- Wheel with half-rounded groove
- Galet avec gorge demi-ronde
- Schiebetorrolle mit Rundrille

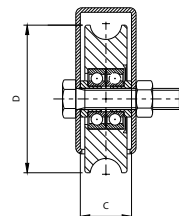

315i W

2 CUSCINETTI
2 BEARINGS

	D	C							€
315i-100	Ø19	Ø 98	34	inox	400 Kg	2	2,8		€ 87,955
315i-120	Ø19	Ø 117	34	inox	420 Kg	2	4,0		€ 106,145
315i-140	Ø19	Ø 137	44	inox	540 Kg	2	6,3		€ 181,970
315i-160	Ø19	Ø 157	44	inox	770 Kg	2	8,9		€ 242,882
315i-200	Ø19	Ø 197	44	inox	800 Kg	2	14,5		€ 331,329

Categoria commerciale: 2M



- Ruota con supporto interno gola V
- Wheel with internal plate, V groove
- Galet avec platine interne, gorge V
- Schiebetorrolle mit Innenstützplatte und V-Rille

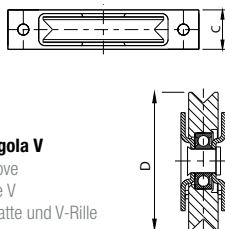

335i W

1 CUSCINETTO
1 BEARING

	D	C							€
335i-V90	Ø 88	33	inox	190 Kg	2	2,4			€ 87,715
335i-V100	Ø 98	33	inox	200 Kg	2	2,8			€ 81,885
335i-V120	Ø 117	38	inox	220 Kg	2	4,4			€ 109,180

Categoria commerciale: 2M



- Ruota con supporto interno gola V
- Wheel with internal plate, V groove
- Galet avec platine interne, gorge V
- Schiebetorrolle mit Innenstützplatte und V-Rille

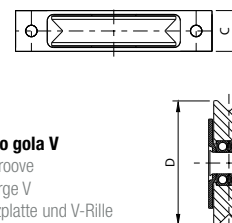

336i W

2 CUSCINETTI
2 BEARINGS

	D	C							€
336i-V90	Ø 88	33	inox	300 Kg	2	2,6			€ 101,614
336i-V100	Ø 98	33	inox	380 Kg	2	3,2			€ 110,752
336i-V120	Ø 117	38	inox	400 Kg	2	5,0			€ 149,620

Categoria commerciale: 2M



- Ruota supporto interno gola semitonda
- Wheel with internal plate, half-rounded groove
- Galet avec platine interne, gorge demi-ronde
- Schiebetorrolle mit Rundrille und Innenstützplatte

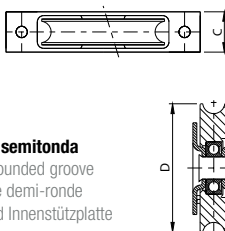

337i W

1 CUSCINETTO
1 BEARING

	D	C							€
337i-90S	Ø19	Ø 88	33	inox	190 Kg	2	2,3		€ 89,986
337i-100S	Ø19	Ø 98	33	inox	200 Kg	2	2,7		€ 81,885
337i-120	Ø19	Ø 117	38	inox	220 Kg	2	4,2		€ 109,180

Categoria commerciale: 2M



- Ruota supporto interno gola semitonda a 2 cuscinetti
- Wheel with internal plate, half-rounded groove and 2 bearings
- Galet avec platine interne, gorge demi-ronde et 2 roulements
- Schiebetorrolle mit Rundrille, Innenstützplatte und 2 Kugellagern

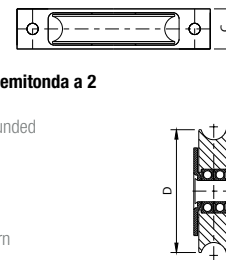

338i W

2 CUSCINETTI
2 BEARINGS

	D	C							€
338i-90	Ø19	Ø88	33	inox	300 Kg	2	2,5		€ 91,635
338i-100	Ø19	Ø98	33	inox	380 Kg	2	3,0		€ 97,651
338i-120	Ø19	Ø117	38	inox	400 Kg	2	4,8		€ 140,034

Categoria commerciale: 2M

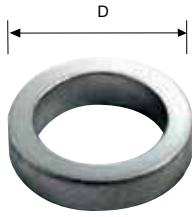

- Rondella in acciaio Inox
- Stainless steel washer
- Rondelle en acier Inox
- Zwischenring aus Edelstahl

401i

	D							
401i-6	Ø9	inox	200	0,2	€ 0,273			
401i-8	Ø12	inox	200	0,2	€ 0,229			
401i-10	Ø15	inox	200	0,4	€ 2,631			
401i-11	Ø15	inox	200	0,2	€ 0,251			
401i-12	Ø18	inox	200	0,6	€ 0,262			
401i-14	Ø19	inox	200	0,4	€ 0,284			

Categoria commerciale: 2E



- Cerniera a 2 ali con perno sfilabile
- Hinge with 2 wings and extractable pivot
- Paumelle avec 2 ailes et pivot à déboîter
- Anschweißband 2-teilig mit lösem Zapfen

402i

	L	A	D					
402i-60	58	26	Ø5,7	inox	50 Kg*	20	0,8	€ 4,324
402i-80	83	38	Ø7,7	inox	75 Kg*	20	1,6	€ 5,459
402i-100	104	48	Ø8,7	inox	100 Kg*	20	2,3	€ 8,494
402i-120	122	57	Ø9,8	inox	150 Kg*	20	3,8	€ 9,706
402i-140	144	68	Ø10,7	inox	200 Kg*	20	4,4	€ 11,824

* valore portata a coppia L/H=1 / capacity of couple hinges L/H=1

Categoria commerciale: 2E



- Cerniera pesante a 2 ali con perno sfilabile
- Heavy hinge with 2 wings and extractable pivot
- Paumelle lourde avec 2 ailes et pivot à déboîter
- Anschweißband 2-teilig schwere Ausführung mit lösem Zapfen



- Cerniera a 3 ali con perno sfilabile
- Hinge with 3 wings and extractable pivot
- Paumelle avec 3 ailes et pivot à déboîter
- Anschweißband 3-teilig mit lösem Zapfen

405i

	L	A	D					
405i-140	145	68	Ø11,7	inox	250 Kg*	20	6,1	€ 10,896
405i-170	174	83	Ø11,7	inox	250 Kg*	20	7,4	€ 15,165
405i-200	205	98	Ø13,6	inox	350 Kg*	16	8,7	€ 24,784

* valore portata a coppia L/H=1 / capacity of couple hinges L/H=1

Categoria commerciale: 2E

410i

	L	A	B	D				
410i-80	83	18	38	Ø7,7	inox	75 Kg*	20	1,7
410i-100	104	23,5	48	Ø8,7	inox	100 Kg*	20	2,3
410i-120	122	27	57	Ø9,8	inox	150 Kg*	20	3,7
410i-140	144	33	68	Ø10,7	inox	200 Kg*	20	4,8

* valore portata a coppia L/H=1 / capacity of couple hinges L/H=1

Categoria commerciale: 2E



- Cerniera pesante a 3 ali con perno sfilabile
- Heavy hinge with 3 wings and extractable pivot
- Paumelle lourde avec 3 ailes et pivot à déboîter
- Anschweißband 3-teilig schwere Ausführung mit lösem Zapfen

415i

	L	A	B	D				
415i-140	145	36	62	Ø11,7	inox	250 Kg*	10	3,1
415i-170	174	44	75	Ø11,7	inox	250 Kg*	20	7,4
415i-200	205	52	89	Ø13,6	inox	350 Kg*	16	8,6

* valore portata a coppia L/H=1 / capacity of couple hinges L/H=1

Categoria commerciale: 2E

NEW



- Cerniera a 2 ali con tappo saldato
- Plug welded hinge with 2 wings
- Paumelle à 2 ailes avec bouchon soudé
- Anschweißband 2-teilig mit Anschweißpfropfen

420i

	L	A	D					
420i-60	inox	64	26	Ø5,8	50 Kg*	20	0,7	4,700
420i-80	inox	89,5	38	Ø7,8	75 Kg*	50	3,2	5,500
420i-100	inox	110	48	Ø8,7	100 Kg*	50	4,4	7,300
420i-120	inox	130	57	Ø9,8	150 Kg*	50	7,0	8,600
420i-140	inox	152	68	Ø10,8	200 Kg*	50	9,0	10,800

* valore portata a coppia L/H=1 / capacity of couple hinges L/H=1

Categoria commerciale: 2E

NEW

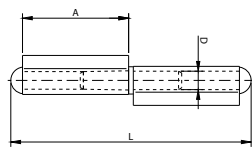

- **Cerniera pesante a 2 ali con tappo saldato**
- Heavy plug welded hinge with 2 wings
- Paumelle lourde à 2 ailes avec bouchon soudé
- Anschweißband 2-teilig schwere Ausführung mit Pfropfen

425i

		L	A	D				€
425i-170	inox	184,5	83	Ø11,8	250 Kg*	20	5,2	17,500
425i-200	inox	217,5	98	Ø13,8	350 Kg*	20	7,8	22,000

* valore portata a coppia L/H=1 / capacity of couple hinges L/H=1

Categoria commerciale: 2E

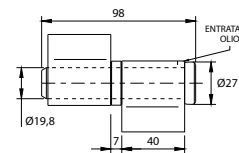

- **Cernierona a 2 ali aperte perno sfilabile con rondella in ottone**
- Big hinge 2 open wings extractable pivot with brass washer
- Paumelle grande 2 ailes ouvertes pivot à déboîter avec rondelle en laiton
- Winkelband mit 2 offenen Flügeln schwere Ausführung loser Zapfen mit Unterlegscheibe aus Messing

440i

					€
440i-90	inox	800 Kg*	4	2,2	€ 32,230

* valore portata a coppia L/H=1 / capacity of couple hinges L/H=1

Categoria commerciale: 2E

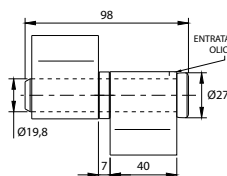

- **Cernierona a 2 ali chiuse perno sfilabile con rondella in ottone**
- Big hinge 2 closed wings extractable pivot with brass washer
- Paumelle grande 2 ailes fermées avec pivot à déboîter et rondelle en laiton
- Flachband 2-teilig schwere Ausführung mit losem Zapfen und Unterlegscheibe aus Messing

450i

					€
450i-90	inox	400 Kg*	4	2,2	€ 33,136

* valore portata a coppia L/H=1 / capacity of couple hinges L/H=1

Categoria commerciale: 2E

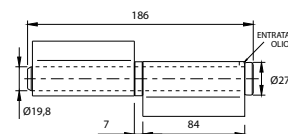

- **Cernierona a 2 ali lunghe aperte perno sfilabile con rondella in ottone**
- Big hinge 2 long open wings extractable pivot with washer and bearing
- Paumelle grande 2 ailes grandes et ouvertes, pivot à déboîter avec rondelle et roulement
- Winkelband mit 2 langen offenen Flügeln schwere Ausführung mit losem Zapfen, Unterlegscheibe und Kugellager

456i

					€
456i-180	inox	800 Kg	4	4,3	40,386

* valore portata a coppia L/H=1 / capacity of couple hinges L/H=1

Categoria commerciale: 2E

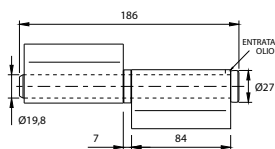

- **Cernierona a 2 ali lunghe chiuse perno sfilabile con rondella in ottone**
- Big hinge 2 closed wings extractable pivot with brass washer
- Paumelle grande 2 ailes fermées avec pivot à déboîter et rondelle en laiton
- Flachband 2-teilig schwere Ausführung mit losem Zapfen und Unterlegscheibe aus Messing

458i

					€
458i-180	inox	800 Kg*	4	4,1	€ 40,440

* valore portata a coppia L/H=1 / capacity of couple hinges L/H=1

Categoria commerciale: 2E

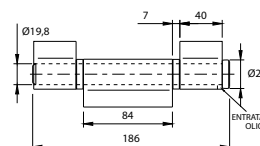

- **Cernierona a 3 ali aperte perno sfilabile con rondelle in ottone**
- Big hinge 3 open wings extractable pivot with brass washers
- Paumelle grande 3 ailes ouvertes avec pivot à déboîter et rondelles en laiton
- Winkelband 3-teilig schwere Ausführung mit losem Zapfen und Unterlegscheibe aus Messing

460i

					€
460i-180	inox	800 Kg*	4	4,3	€ 45,408

* valore portata a coppia L/H=1 / capacity of couple hinges L/H=1

Categoria commerciale: 2E

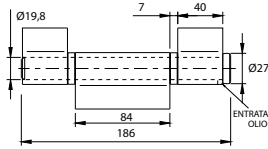

- Cerniera a 3 ali chiuse perno sfilabile con rondella in ottone
- Big hinge 3 closed wings extractable pivot with washer
- Paumelle grande 3 ailes fermées avec pivot à déboiter et rondelle
- Flachband 3-teilig schwere Ausführung mit losem Zapfen und Unterlegscheibe

470i

470i-180	800 Kg*	4	4,20	€ 46,915

* valore portata a coppia L/H=1 / capacity of couple hinges L/H=1

Categoria commerciale: 2E

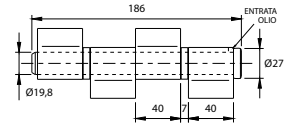

- Cerniera a 4 ali aperte perno sfilabile con rondelle in ottone
- Big hinge 4 open wings extractable pivot with brass washers
- Paumelle grande 4 ailes ouvertes avec pivot à déboiter et rondelles en laiton
- Winkelband 4-teilig schwere Ausführung mit losem Zapfen und Unterlegscheiben aus Messing

480i

480i-180	inox	800 Kg*	4	4,1	€ 46,052

* valore portata a coppia L/H=1 / capacity of couple hinges L/H=1

Categoria commerciale: 2E

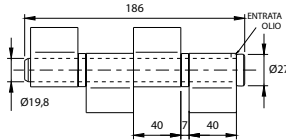

- Cerniera a 4 ali chiuse perno sfilabile con rondelle in ottone
- Big hinge 4 closed wings extractable pivot with brass washers
- Paumelle grande 4 ailes fermées avec rondelles et pivot à déboiter
- Flachband 4-teilig schwere Ausführung mit losen Zapfen und Unterlegscheiben aus Messing

485i

485i-180	inox	800 Kg*	4	4,1	€ 47,799

* valore portata a coppia L/H=1 / capacity of couple hinges L/H=1

Categoria commerciale: 2E

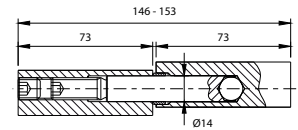

- Cerniera a goccia tornita perno acciaio regolabile 7 mm
- Turned drop hinge, 7mm adjustable, with steel pivot
- Paumelle à goutte tournée, réglable 7mm. avec pivot en acier
- Formgepresstes und 7 mm-verstellbares Tropfenband mit Zapfen aus Stahl

500i

500i-150	inox	146-153	300 Kg*	10	3,9	€ 49,459

* valore portata a coppia L/H=1 / capacity of couple hinges L/H=1

Categoria commerciale: 2E



- Chiavistello inox
- Stainless steel latch
- Verrou inox
- Riegel aus Edelstahl

620i

620i	inox	50	2,1	€ 5,044

Categoria commerciale: 2G

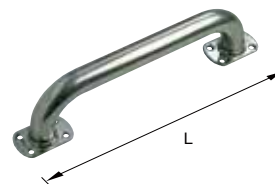

- Maniglione tubolare diritto in acciaio inox aisi 316l
- Straight s/s aisi 316l pull handle
- Poignée droite en acier inox aisi 316l
- Gerader Rohrformiger Stosgriff aus Edelstahl aisi 316l

679i

679i	Ø30	inox	1	0,7	€ 48,640

Categoria commerciale: 2H



- **Catenaccio autobloccante da avvitare punta tonda Ø12 Corsa 30mm**
- Self-locking bolt to be screwed with rod Ø 12 Stroke 30mm
- Verrou autobloquant à visser avec pointe ronde Ø 12 Course 30mm
- Selbstsperrender Stangenriegel zum Anschrauben mit Stange Ø 12 Hub 30mm

730i

730i	inox	4	1,6	€ 30,330

Categoria commerciale: 2D

NEW



- **Paletti automatici per cancelli a 2 ante**
- Automatic bolt for 2 leaf gates
- Verrous autobloquants
- Automatisch Riegel

732i

732i	inox	6	2,53	€ 42,586

Categoria commerciale: 2D



- **Contro piastra per carrelli piccolo**
- Counter plate for carriages small
- Contre-plaque pour chariots peti
- Gegenplatte für Laufwagen gross

CGi-05

CGi-05P	Piccolo	inox	2	2,7	€ 50,037

Categoria commerciale: 1T

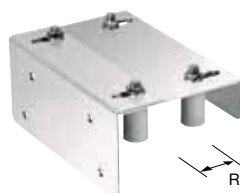

- **Piastra guida cancello regolabile con ala lunga a fissare**
- Adjustable gate guide to be fixed with long wing side plate
- Plaque guide portail réglable à fixer avec aile longue
- Verstellbare Torführungsplatte mit langem Flügel zum Aufschrauben

CGi-251

CGi-251	L=350 Ø40	inox	70-110	1	6,7	€ 333,610

Categoria commerciale: 1S



- **Incontro inferiore a fissare**
- Bottom end cup to be fixed
- Butée inférieure à fixer
- Unterauflageschuh zum Aufschrauben

CGi-346

CGi-346P	Piccolo	inox	2	3,5	€ 78,850

Categoria commerciale: 1T



- **Ruota terminale per monorotaia**
- End wheel for monorail
- Galet d'extrémité pour rail
- Endrad für Einfachschiene

CGi-347

CGi-347P	Piccolo	inox	2	3,4	€ 206,230

Categoria commerciale: 1T



- **Ancorante filettato per carrelli CGS 350 e CGS 350.8**
- Threaded tie rods for carriages CGS 350 and CGS 350.8
- Tirant fileté pour chariots CGS 350 et CGS 350.8
- Gewindestange für Laufwagen CGS 350 e CGS 350.8

CGi-348

CGi-348	M16	inox	12	8,3	€ 45,495

Categoria commerciale: 1T

CGi-350.5 iNOX PICCOLO



CARATTERISTICHE

- Corpo monoblocco che assicura resistenza alla struttura
- Indicato per i climi più umidi in quanto evita la corrosione del carrello
- Cuscinetti silenziosi di nuova generazione schermati per una migliore protezione dalla polvere; adatti a temperature che vanno dai -30° ai +80°
- 4 ruote di supporto in acciaio inox
- Rotella centrale di allineamento
- Perno centrale di rotazione

FEATURES

- Monoblock body that ensure strenght to the structure
- Suitable to the humid climate to avoid the carriage corrosion
- Noiseless bearings of new generation shielded to protect against dust suitable for temperatures from -30 ° C to + 80 ° C
- 4 support stainless steel wheels
- Alignment central wheel
- Central rotation pin

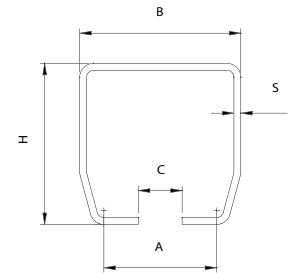
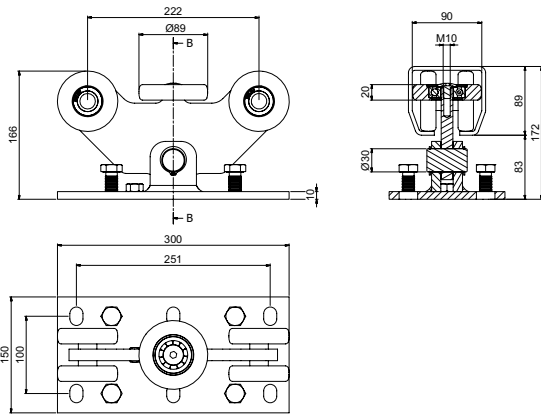

CGi-350.5P

- Carrello autoportante 5 ruote per cancelli a sbalzo
- 5 wheels cantilever carriage for gates
- Chariot autoportant 5 roues pour portails
- 5-rädriger Laufwagen für freitragende Tore

CGi-350P	1000 Kg	CGS-345P	4 x CGS-348 M16	inox	1	11,0	€ 906,805
----------	---------	----------	-----------------	------	---	------	-----------

Categoria commerciale: 1Q

CGi-345P

- Monorotaia in acciaio inox per cancelli auto-portanti
- Monorail in stainless steel for cantilever gates
- Rail en aluminium extrudé pour portails autoportants
- Einfachschiene aus fließgepresstem Aluminium für selbsttragende Tore

CGi-345P	Piccolo	inox	3000	100	89	5	1	32,3	€ 970,490
CGi-345P	Piccolo	inox	6000	100	89	5	1	72,5	€ 2.153,270

Categoria commerciale: 1R

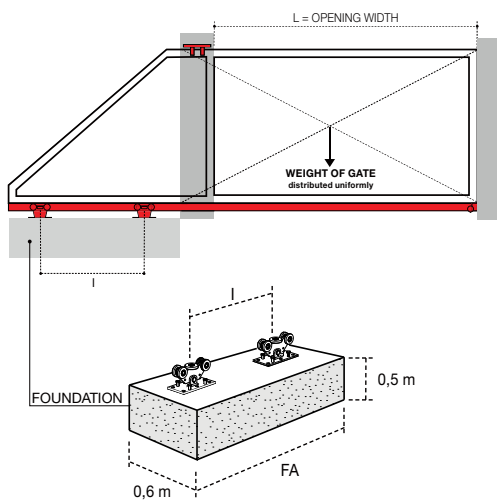

CGi -350.5 P (F1max = 1000 Kg)										
	L=2,5 m		L=3 m		L=3,5 m		L=4 m		L=4,5 m	
Weight (Kg)	FA (m)	I (m)	FA (m)	I (m)	FA (m)	I (m)	FA (m)	I (m)	FA (m)	I (m)
250	1,70	1,00	2,00	1,30	2,30	1,60	2,70	2,00	3,10	2,40
275	1,80	1,10	2,20	1,50	2,50	1,80	2,90	2,20	3,30	2,60
300	2,00	1,30	2,30	1,60	2,70	2,00	3,20	2,50	3,60	3,00
325	2,10	1,40	2,50	1,80	3,00	2,30	3,50	2,80	4,00	3,30
350	2,30	1,60	2,70	2,00	3,20	2,50	3,80	3,10	4,40	3,70
375	2,50	1,80	3,00	2,30	3,50	2,80	4,10	3,40	4,80	4,10
400	2,70	2,00	3,20	2,50	3,80	3,10	4,50	3,80	5,20	4,60

Life
made
easy

COMUNELLO
GATE DIVISION



Industrial door components



LEGENDA

	Articolo / Article		Pezzi per confezione / Pieces per pack
	Misura specifica / Measure		Peso confezione / Weight of pack
	Finitura / Finishing		Prezzo / Price
	Regolazione / Regulation		Su richiesta / On request
	Portata / Capacity		Lubrificazione / Greasing
	Portata singolo carrello / Capacity of single carriage		Cuscinetti / Bearings
	Abbinamento monorotaia / Related monorail		Accessori in acciaio inox / S-Steel accessories
	Abbinamento tiranti / Related tie roads		



- **Tappo ammortizzatore ante**
- Door leaf stopper
- Embout d'amortissage vantaux
- Stossdämpfer für Türe

239

239	10	0,6	3,232	

Categoria commerciale: 3E



- **Battente finecorsa per monorotaie art. 398/399**
- End-stopper for guides art. 398/399
- Butee de fin de course pour rails art. 398/399
- Letzter Türflügel für Laufschiene art. 398/399

246

246	zinc	4	1,3	12,669

Categoria commerciale: 3G

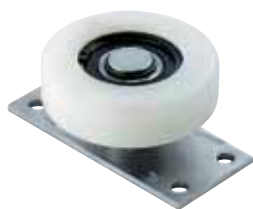

- **Guida per portoni scorrevoli**
- Guide for sliding doors
- Guide pour portails coulissants
- Führung für Schiebetüren

248

248-60	Ø60	zinc	4	2,2	29,215
248-70	Ø70	zinc	4	1,8	31,543
248-80	Ø80	zinc	4	2,1	33,741

Categoria commerciale: 3H



- **Deviatore regolabile per impacchettamento laterale**
- Adjustable switcher for side folding
- Deviateur réglable pour portail pliable lateral
- Regulierbarer Ablenker für seitliche Paket-Lagerung

249-30

249-30	zinc	4	3,8	27,018

Categoria commerciale: 3E



- **Maniglia ad incasso**
- Flush-mounted handle
- Poignée à encaisser
- Muschelgriff

270

270P	Piccolo	zinc	30	2,5	3,046
270G	Grande	zinc	30	7,3	6,977

Categoria commerciale: 1H



- **Maniglia ad incasso con leva**
- Flush-mounted handle with lever
- Poignée à encaisser avec levier
- Muschelgriff mit Triebriegel

272

272	Grande	zinc	30	11,4	10,580

Categoria commerciale: 1H



- **Staffa regolabile a parete mm. 185**
- Adjustable wall rod 185 mm.
- Support réglable au mur mm. 185
- Regulierbarer Wandbügel 185 mm.

354 185

354-185	piccolo	zinc	47-165	150 Kg	2	2,8	15,383

Categoria commerciale: 3G

Distanza massima raccomandata considerando un carico di R = 310 applicato sulla parte finale: 700 mm
Recommended maximum distance considering a load of R = 310 applied on the end part: 700 mm
Distance maximal recommandée considérant une charge de R = 310 appliquée sur la partie finale: 700 mm
Maximal empfohlene Entfernung bei einer am Endteil angebrachten Ladung von R=310 beträgt 700mm



- **Staffa regolabile a parete mm. 330**
- Adjustable wall rod 330 mm.
- Support réglable au mur mm. 330
- Regulierbarer Wandbügel 330 mm

354 330

354-330	grande	zinc	47-310	130 Kg	2	4,8	20,684

Categoria commerciale: 3G

Distanza massima raccomandata considerando un carico di R = 310 applicato sulla parte finale: 700 mm
Recommended maximum distance considering a load of R = 310 applied on the end part: 700 mm
Distance maximal recommandée considérant une charge de R = 310 appliquée sur la partie finale: 700 mm
Maximal empfohlene Entfernung bei einer am Endteil angebrachten Ladung von R=310 beträgt 700mm



- **Supporto guida regolabile**
- Adjustable guide support
- Support guide réglable
- Regulierbarer Ablenker führung

355

355 P	piccolo	zinc	150 Kg	2	2,6	20,295
355 G	grande	zinc	200 Kg	2	3,3	21,589

Categoria commerciale: 3G



- **Supporto regolabile a saldare**
- Adjustable switcher to be welded
- Deviateur réglable à souder
- Regulierbarer Ablenker zum Schweißen

355 S

355/S	zinc	200 Kg	4	2,1	13,057

Categoria commerciale: 3G



- **Supporto a soffitto**
- Adjustable switcher
- Deviateur réglable au mur
- Regulierbarer Ablenker

356

356 P	piccolo	zinc	150 Kg	2	4,1	38,265

Categoria commerciale: 3G

Distanza massima raccomandata: 700 mm
Recommended maximum distance: 700 mm
Distance maximal recommandée: 700 mm
Maximal empfohlene Entfernung beträgt 700mm

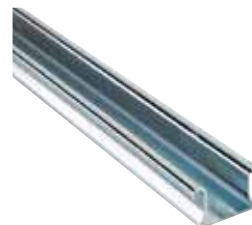

- **Guida inferiore a cementare da mt. 6,00**
- Lower guide to be cemented, length 6 meters
- Guide inferieure à sceller de m. 6,00
- Untere Schiene zum Einzementieren, Länge 6 m

358

358	L=6000	zinc	1	21,3	160,558

Categoria commerciale: 3G



- **Incontro a pavimento in alluminio**
- Aluminium floor strike plate
- Butoir au sol en aluminium
- Bodenaufschuh aus Aluminium

361

361 P	piccolo	2	1,2	40,463
361 G	grande	2	1,2	40,463

Categoria commerciale: 3E



- **Battuta per ante intermedie in alluminio**
- Step for intermediate ante in aluminium
- Butee pour vantaux intermediaires en aluminium
- Stütze für mittleren Türflügel aus Aluminium

362

362		2	1,2	35,938

Categoria commerciale: 3E



- **Incontro a pavimento in alluminio**
- Aluminium floor strike plate
- Guidage au sol en aluminium
- Bodenaufschuh aus Aluminium

363

363		2	2,5	73,205

Categoria commerciale: 1G



- **Incontro a pavimento in alluminio regolabile**
- Adjustable aluminium floor strike plate
- Butoir au sol en aluminium réglable
- Bodenaufschuh aus Aluminium regulierbar

364

364	D=18-43	2	1,4	44,988

Categoria commerciale: 3E



- **Incontro per aste**
- Floor strike plate for rods
- Butoir pour tringles
- Aufschuh für Stangen

365

365	acciaio/steel	zinc	10	1,9	5,947
365 AL	alluminio/aluminium		10	1,9	5,947

Categoria commerciale: 3E



- **Incontro a pavimento per chiusura antipanico**
- Floor strike plate for panic exit device
- Butoir au sol pour fermeture antipanique
- Bodenaufschuh für Antipaniktür

366

366-42	S = 42	2	1,5	49,382	

Categoria commerciale: 3E



367

- **Incontro a pavimento in nylon nero, con rinforzo in acciaio**
- Black nylon floor strike plate, with steel reinforcement
- Butoir au sol en nylon noir, avec renfort en acier
- Bodenaufaufschuh aus schwarzem Nylon mit Verstärkung aus Stahl

367 A	2	0,6				22,280

Categoria commerciale: 3E



375 P

- **Carrello piccolo a 4 ruote in acciaio**
- Small steel trolley with four wheels
- Chariot petit à 4 galets en acier
- Rollenapparat klein mit 4 Stahlrollen

375P-16	16 mm	zinc	Ø16,3	400 Kg	4	3,2	38,265
375P-20	20 mm	zinc	Ø20,5	400 Kg	4	3,2	38,265

Categoria commerciale: 3B

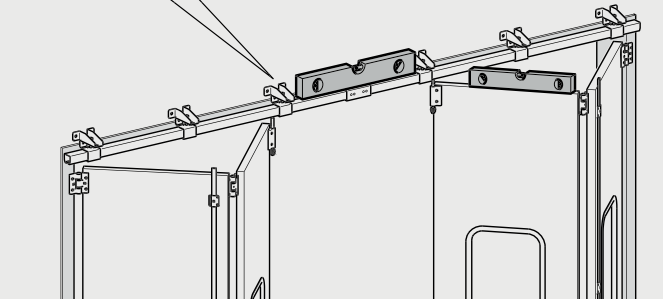
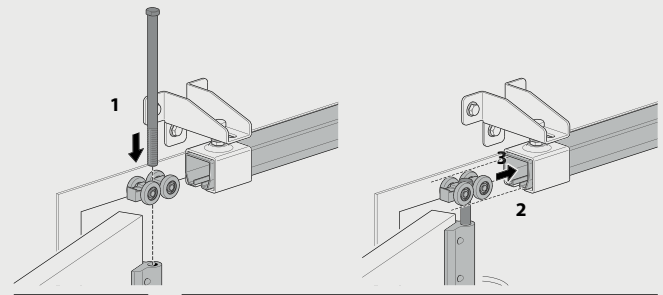

375 G

- **Carrello grande a 4 ruote in acciaio per perno da mm. 20**
- Large steel trolley with four wheels for pin, 20 mm.
- Chariot grand à 4 galets en acier pour pivot de mm. 20
- Rollenapparat gross mit 4 Stahlrollen

375 G	grande	zinc	800 Kg	4	9,2	67,352

Categoria commerciale: 3B



376 P

- **Carrello piccolo a 4 ruote in nylon**
- Small nylon trolley with four wheels
- Chariot petit à 4 galets en nylon
- Rollenapparat klein mit 4 Nylonrollen

376 P/16	16 mm	zinc	Ø16,3	400 Kg	4	2,1	24,691
376 P/20	20 mm	zinc	Ø20,5	400 Kg	4	2,1	24,691

Categoria commerciale: 3B



377

- **Perno superiore per carrelli**
- Upper pin for trolleys
- Pivot superieur pour chariots
- Oberer Bolzen für Rollenapparate

377P	Piccolo	Zinc		400 kg	4	1,6	16,160
377G-290	Grande	Zinc		800 kg	4	3,1	17,064
377G-290	Grande	Zinc Black		800 kg	4	3,1	18,486
377G-330	Grande	Zinc		800 kg	4	3,5	17,969
377G-330	Grande	Zinc Black		800 kg	4	3,5	19,391

Categoria commerciale: 3E



- Perno superiore ribassato
- Lowered upper pin
- Pivot supérieur surbaisse
- Oberer Bolzen herabgesenkt

377 R

Icona	Materiali	Peso	Quantità	Prezzo Unitario	Prezzo Totale
	zinc	400 Kg	4	3,6	17,969
	zinc nero	400 Kg	4	3,6	19,391

Categoria commerciale: 3E



- Perno superiore per scorrevoli zincato
- Galvanized upper pin for sliding doors
- Pivot supérieur pour portail coulissant zingué
- Oberer Bolzen für Schiebetüren verzinkt

377 G-SC

Icona	Materiali	Peso	Quantità	Prezzo Unitario	Prezzo Totale
	zinc	400 Kg	4	1,4	11,118

Categoria commerciale: 3E



- Perno inferiore regolabile
- Adjustable lower pin
- Pivot inférieur réglable
- Unterer Bolzen regulierbar

378

Icona	Dimensioni	Materiali	Quantità	Prezzo Unitario	Prezzo Totale
	piccolo	zinc	4	0,8	13,573
	grande	zinc	4	1,8	14,478

Categoria commerciale: 3E



- Perno inferiore regolabile con cuscinetto
- Adjustable lower pin with bearing
- Pivot inférieur réglable avec roulement
- Unterer Bolzen mit Kugellager regulierbar

379

Icona	Dimensioni	Materiali	Quantità	Prezzo Unitario	Prezzo Totale
	piccolo	zinc	4	1,0	16,676
	grande	zinc	4	1,5	14,478
	grande	zinc nero	4	1,5	16,676
	grande	zinc	4	2,2	16,676
	grande	zinc nero	4	2,2	18,874

Categoria commerciale: 3E



- Profilo ad "u" per deviatori ad impacco laterale
- "U" profile for side folding switches
- Profil en "u" pour deviateurs pour portail pliable lateral
- U-Profil für Ablenker für seitliche Paket-Lagerung

387

Icona	Dimensioni	Materiali	Quantità	Prezzo Unitario	Prezzo Totale
	L=6000	Ral 9005	1	9,4	134,703

Categoria commerciale: 3G



- Bandiera reversibile per impacco laterale 4 ante
- Reversible jib for 4-leaf side folding
- Penture reversible pour portail pliable lateral 4 vantaux
- Reversible schwenkplatte für seitliche paket-lagerung bei 4 türen

388

Icona	Materiali	Quantità	Prezzo Unitario	Prezzo Totale
	ral 9005	1	12,50	628,529

Categoria commerciale: 3E



- Carrello in alluminio pressofuso a 3 ruote
- Die-cast aluminium trolley with three wheels
- Chariot en aluminium moule a 3 galets
- Rollenapparat aus Alu-druckguss mit 3 Rollen

395 DX-SX

Icona	Modello	Colorazione	Caratteristiche	Quantità	Dimensioni	Prezzo
	395 DX	Ral 9005	*	4	2,3	24,691
	395 SX	Ral 9005	*	4	2,3	24,691

Categoria commerciale: 3B

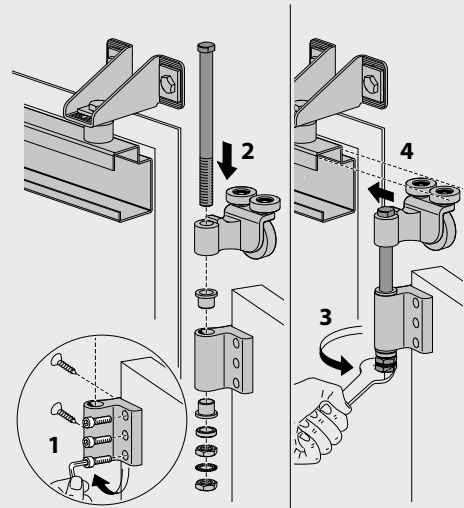

- Carrello reversibile in alluminio a 3 ruote
- Reversible aluminium trolley with three wheels
- Chariot reversible en aluminium a 3 galets
- Reversibler Rollenapparat aus Aluminium mit 3 Rollen

396

Icona	Modello	Colorazione	Peso	Quantità	Dimensioni	Prezzo
	396	Ral 9005	280 Kg	4	3,6	62,827

Categoria commerciale: 3B

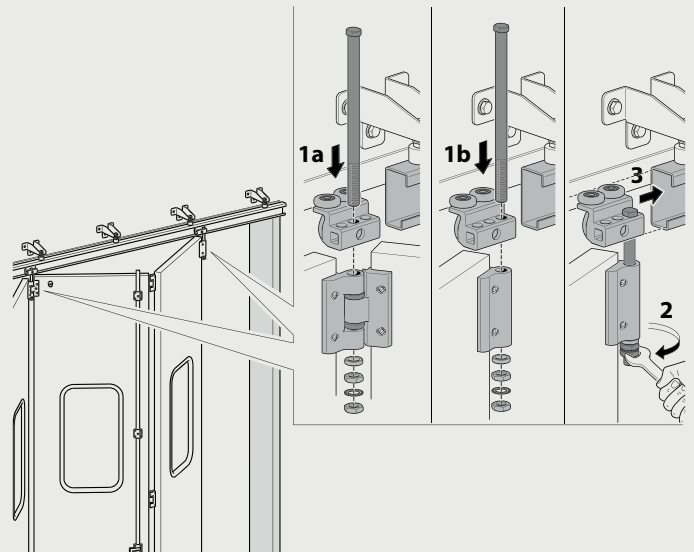

- Monorotaia superiore per carrelli 4 ruote grande zincata
- Large galvanized upper guide for trolleys with four wheels
- Rail supérieur pour chariots 4 galets grands zingues
- Obere Laufschiene für Rollenapparate mit 4 Rollen
- gross verzinkt

398

Icona	Modello	Material	Quantità	Dimensioni	Prezzo
	398 L=3000	zinc	1	30,4	269,406
	398 L=6000	zinc	1	60,7	538,684

Categoria commerciale: 3G

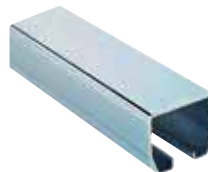

- Monorotaia superiore per carrelli 4 ruote piccola zincata
- Small galvanized upper guide for trolleys with four wheels
- Rail supérieur pour chariots 4 galets petite zingues
- Obere Laufschiene für Rollenapparate mit 4 Rollen
- klein verzinkt

399

Icona	Modello	Material	Quantità	Dimensioni	Prezzo
	399 L=3000	zinc	1	16,7	103,290
	399 L=5500	zinc	1	30,4	179,562
	399 L=6000	zinc	1	33,3	197,531

Categoria commerciale: 3G



- Maniglione curvo Ø15 mm
- Bended pull handle dia.15mm
- Poignée courbée dia.15mm
- Gebogener Stosssgriff Durchm.15 mm

671

	L					
671P	215	Ø15	Ral 9005	10	6,4	10,197
671G	265	Ø15	Ral 9005	10	7,1	10,481

Categoria commerciale: 1H



- Cariglione star piccolo
- Small star lever bolt
- Cremone star petite
- Treibriegel star klein

690 MC

			CORSA*			
690 MC	DX	nero	31	2	1,9	41,497
690 MC	DX	zinc	31	2	1,9	36,973
690 MC	SX	nero	31	2	1,8	41,497
690 MC	SX	zinc	31	2	1,8	36,973

Categoria commerciale: 3A

*MOVIMENTAZIONE ASTE - OPENING AND CLOSING RODS - MANUTENTION TRINGLES - STANGE BEWEGUNG



- Passante per aste 25x10
- Rod guide 25x10
- Traversant pour tringles 25x10
- Lasche für Stangen 25x10

691 P

691 P	25x10	nero	50	2,7		3,619
691 P	25x10	zinc	50	2,8		2,973

Categoria commerciale: 3A



- Passante per asta 30x10
- Rod guide for 30 x 10 rod
- Traversant pour tringle 30x10
- Führungsaufnahme für Verbindungsstange 30x10

691 G

691 G	30x10	nero	50	7,1		3,619
691 G	30x10	zinc	50	7,1		2,973

Categoria commerciale: 3A



- Asta di collegamento 30x10
- Connection rod 30x10
- Tringle de jonction 30x10
- Verbindungsstange 30x10

692 G

692G-30x10	L=1200	nero	1	2,80		€ 35,938
692G-30x10	L=1200	zinc	1	2,80		€ 31,801
692G-30x10	L=3000	nero	1	7,00		€ 75,237
692G-30x10	L=3000	zinc	1	7,00		€ 70,066
692G-30x10	L=4800	nero	1	11,30		€ 107,814
692G-30x10	L=4800	zinc	1	11,30		€ 102,772

Categoria commerciale: 3A



- Asta di collegamento 25x10
- Connection rod 25x10
- Tringle de jonction 25x10
- Verbindungsstange 25x10

692 P

692P-25x10	L=1200	nero	1	2,3		€ 33,094
692P-25x10	L=1200	zinc	1	2,3		€ 29,022
692P-25x10	L=3000	nero	1	5,9		€ 70,584
692P-25x10	L=3000	zinc	1	5,9		€ 66,317
692P-25x10	L=4800	nero	1	9,5		€ 103,161
692P-25x10	L=4800	zinc	1	9,5		€ 98,635

Categoria commerciale: 3A



- Cariglione star piccolo per aste interne
- Small star lever bolt for internal rods
- Crémone star petite pour tringles intérieures
- Treibriegel star klein für innenstangen

693 MC

			CORSA*			
693 MC	DX	Ral 9005	31	2	2,5	46,150
693 MC	SX	Ral 9005	31	2	2,5	46,150

Categoria commerciale: 3A



- Cariglione star grande
- Large star lever bolt
- Crémone star grande
- Treibriegel star gross

694 MC

			CORSA*			€
694 MC	DX	nero	40	2	3,8	48,995
694 MC	DX	zinc	40	2	3,8	44,988
694 MC	SX	nero	40	2	3,8	48,995
694 MC	SX	zinc	40	2	3,8	44,988

Categoria commerciale: 3A



- Asta di collegamento tubolare 25x10
- Connection tubular rod 25x10
- Tringle de jonction tubulaire 25x10
- Rohr-Verbindungsstange 25x10

695 P

						€
695P-25x10	L=1200	zinc nero	1	1,3		27,018
695P-25x10	L=1200	zinc	1	1,3		20,295
695P-25x10	L=3000	zinc nero	1	3,4		38,265
695P-25x10	L=3000	zinc	1	3,4		31,543
695P-25x10	L=4800	zinc nero	1	4,7		44,988
695P-25x10	L=4800	zinc	1	4,7		38,265

Categoria commerciale: 3A



- Asta di collegamento tubolare 30x10
- Connection tubular rod 30x10
- Tringle de jonction tubulaire 30x10
- Rohr-Verbindungsstange 30x10

695 G

						€
695G-30x10	L=1200	zinc nero	1	1,2		29,215
695G-30x10	L=1200	zinc	1	1,2		22,493
695G-30x10	L=3000	zinc nero	1	3,4		40,463
695G-30x10	L=3000	zinc	1	3,4		33,741
695G-30x10	L=4800	zinc nero	1	5,4		47,185
695G-30x10	L=4800	zinc	1	5,4		40,463

Categoria commerciale: 3A



- Asta di chiusura tubolare con maniglia 25x10
- Closing tubular rod with handle 25x10
- Tringle tubulaire de fermeture avec poignée 25x10
- Rohrverschlussstange mit Griffe 25x10

695 PM

			L			€
695 PM	1,2 mt	zinc nero	1200	1	1,2	35,938
695 PM	1,2 mt	zinc	1200	1	1,2	29,215

Categoria commerciale: 3A



- Asta di chiusura tubolare con maniglia 30x10
- Closing tubular rod with handle 30x10
- Tringle tubulaire de fermeture avec poignée 30x10
- Rohrverschlussstange mit Griffe 30x10

695 GM

			L			€
695 GM	1,2 mt	zinc nero	1200	1	1,4	38,265
695 GM	1,2 mt	zinc	1200	1	1,4	31,543

Categoria commerciale: 3A



- Cariglione star grande predisposto per cilindro
- Large star lever bolt for cylinder
- Crémone star grande pour cylindre
- Treibriegel star gross für Zylinder

696 MC

			CORSA*			€
696 MC	DX	ral 9005	40	2	3,0	145,433
696 MC	DX	zinc	40	2	3,0	137,547
696 MC	SX	ral 9005	40	2	3,0	145,433
696 MC	SX	zinc	40	2	3,0	137,547

Categoria commerciale: 3A



- Cariglione star grande con maniglia esterna
- Large star lever bolt with external handle
- Cremona star grande avec béquille extérieure
- Treibriegel star gross

698 MC

698 MC DX/50	L=50	Ral 9005	2	4,30	179,949	
698 MC DX/50	L=50	zinc	2	4,30	171,158	
698 MC SX/50	L=50	Ral 9005	2	4,30	179,949	
698 MC SX/50	L=50	zinc	2	4,30	171,158	
698 MC DX/80	L=80	Ral 9005	2	4,35	179,949	
698 MC DX/80	L=80	zinc	2	4,35	€ 171,158	
698 MC SX/80	L=80	Ral 9005	2	4,35	€ 179,949	
698 MC SX/80	L=80	zinc	2	4,45	171,158	

Categoria commerciale: 3A



- Maniglione di trascinamento in nylon con passanti
- Nylon pull handle with guides
- Poignée d'entraînement en nylon avec traversants
- Nylongriff zum Ziehen mit Laschen

699

699	10	2,9			13,573

Categoria commerciale: 3F



- Cerniera doppia piccola in alluminio piana
- Small flat aluminium double hinge
- Paumelle double petite en aluminium plate
- Doppelscharnier klein aus Aluminium flach

A370 P

A370P	piccola	Ral 9005	200 Kg	12	5,9	49,382

Categoria commerciale: 3D



- Cerniera doppia piccola in alluminio senza perno
- Small flat aluminium double hinge, without pin
- Paumelle double petite en aluminium plate, sans pivot
- Doppelscharnier klein aus Aluminium flach, ohne Bolzen

A371 P

A371 P	piccola	Ral 9005	200 kg	4	1,4	45,893

Categoria commerciale: 3D



- Cerniera doppia grande in alluminio con battute
- Large aluminium double hinge with steps
- Paumelle double grande en aluminium avec butées
- Doppelscharnier gross aus Aluminium mit Stützen

A380 G

A380 G	grande	Ral 9005	400 Kg	12	11,7	67,352

Categoria commerciale: 3D



- Cerniera doppia piccola in alluminio con battute
- Small aluminium double hinge with steps
- Paumelle double petite en aluminium avec butées
- Doppelscharnier klein aus Aluminium mit Stützen

A380 P

A380 P	piccola	Ral 9005	200 Kg	12	6,0	49,382

Categoria commerciale: 3D



- **Cerniera doppia in alluminio piana, regolabile**
- Flat aluminium double hinge, adjustable
- Paumelle double en aluminium plate, réglable
- Doppelscharnier aus aluminium flach, regulierbar

A380 R

A380 R	Ral 9005	400 Kg	4	4,0	65,154

Categoria commerciale: 3D

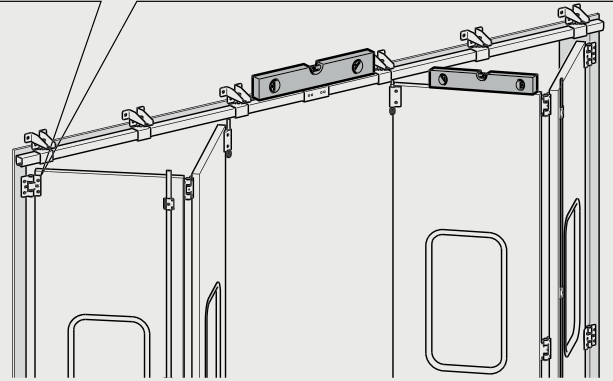
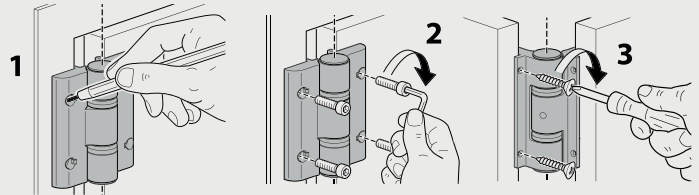

- **Cerniera doppia grande in alluminio con battute, senza perno**
- Large aluminium double hinge with steps, without pin
- Paumelle double grande en aluminium avec butées, sans pivot
- Doppelscharnier gross aus Aluminium mit Stützen, ohne Bolzen

A381 G

A381 G	grande	Ral 9005	400 Kg	4	2,8	62,956

Categoria commerciale: 3D



- **Cerniera doppia piccola in alluminio con battute, senza perno**
- Small aluminium double hinge with steps, without pin
- Paumelle double petite en aluminium, avec butees, sans pivot
- Doppelscharnier klein aus Aluminium mit Stützen, ohne Bolzen

A381 P

A381 P	piccola	Ral 9005	200 Kg	4	2,2	45,893

Categoria commerciale: 3D



- **Cerniera singola piccola in alluminio piana**
- Small flat aluminium hinge
- Paumelle simple petite en aluminium plate
- Einzel-Scharnier klein aus Aluminium flach

A384 P

A384 P	piccola	Ral 9005	150 Kg	4	1,0	31,543

Categoria commerciale: 3D



- **Cerniera singola piccola in alluminio con battuta**
- Small aluminium hinge with step
- Paumelle simple petite en aluminium avec butée
- Einzel-scharnier klein aus Aluminium mit Stütze

A385 P

A385 P	piccola	Ral 9005	150 Kg	4	1,0	31,543

Categoria commerciale: 3D



- **Cerniera singola in alluminio pressofuso con battuta disassata**
- Die-cast aluminium hinge with off-centre step
- Paumelle simple en aluminium moulée avec butée desaxée
- Einzel-Scharnier aus Alu-druckguss mit ausserachsiger Stütze

P365

P365	Ral 9005	200 Kg	4	1,8	20,295

Categoria commerciale: 3D



- **Cerniera singola ridotta in alluminio pressofuso con battuta**
- Reduced die-cast aluminium hinge with step
- Paumelle simple reduite en aluminium moulée avec butée
- Einzel-scharnier reduziert aus Alu-druckguss mit Stütze

P365 R

P365 R	Ral 9005	200 Kg	4	1,6	20,102

Categoria commerciale: 3D



- **Cerniera inferiore in alluminio pressofuso decentrata**
- Off-centre die-cast aluminium lower hinge
- Paumelle inférieure en aluminium moulée décentrée
- Unteres-Scharnier aus Alu-druckguss dezentriert

P368 I

P368 I	Ral 9005	4	2,6	14,866	

Categoria commerciale: 3D



- **Cerniera superiore/inferiore maggiorata decentrata**
- Off-center oversized upper/lower hinge
- Paumelle supérieure/inferieure surdimensionnée décentralisée
- Dezentralisiertes oberes/unteres Scharnier vergrößert

P368 M

P368 M	Ral 9005	200 Kg	4	2,5	33,741

Categoria commerciale: 3D



- **Cerniera superiore in alluminio pressofuso decentrata**
- Off-centre die-cast aluminium upper hinge
- Paumelle supérieure en aluminium moulée décentrée
- Oberes Scharnier aus Alu-druckguss dezentriert

P368 S

P368 S	Ral 9005	130 Kg	4	2,6	14,866

Categoria commerciale: 3D



- **Cerniera doppia in alluminio pressofuso piana**
- Flat die-cast aluminium double hinge
- Paumelle double en aluminium moulée plate
- Doppelscharnier aus Alu-druckguss flach

P370

P370	Ral 9005	300 Kg	12	12,6	31,543

Categoria commerciale: 3D



- **Cerniera doppia in alluminio pressofuso piana, senza perno**
- Flat die-cast aluminium double hinge, without pin
- Paumelle double en aluminium moulée plate, sans pivot
- Doppelscharnier aus alu-druckguss flach, ohne Bolzen

P371

P371	Ral 9005	300 Kg	4	3,1	29,733

Categoria commerciale: 3D



- **Cerniera doppia in alluminio pressofuso con battute**
- Die-cast aluminium double hinge with steps
- Paumelle double en aluminium moulée avec butées
- Doppelscharnier aus Alu-druckguss mit Stützen

P380

P380	Ral 9005	300 Kg	12	13,0	31,543

Categoria commerciale: 3D



- **Cerniera doppia in alluminio pressofuso con battute, senza perno**
- Die-cast aluminium double hinge, without pin
- Paumelle double en aluminium moulée avec butées, sans pivot
- Doppelscharnier aus Alu-druckguss mit Stützen, ohne Bolzen

P381

P381	Ral 9005	300 Kg	4	5,0	29,733

Categoria commerciale: 3D



- **Cerniera singola in alluminio pressofuso con battuta**
- Die-cast aluminium hinge with step
- Paumelle simple en aluminium moulée avec butée
- Einzel-scharnier aus Alu-druckguss mit Stütze

P385

P385	Ral 9005	200 Kg	4	2,2	20,295

Categoria commerciale: 3D



- **Tappo coprivite per cerniera p380**
- Screw cover for hinge p380
- Embout couvre-vis pour paumelle p380
- Stöpsel für p380 schraube

R383-13.5

R383	Ral 9005	200	0,8	0,129

Categoria commerciale: 3E



- **Tappo di testa per cerniera p380**
- Supperper for hinge p380
- Embout de tête pour paumelle p380
- Stöpsel für Scharnierkopf p380

R383-33

R383	Ral 9005	200	0,8	0,388

Categoria commerciale: 3E



- **Perno per cerniera p380**
- Pin for hinge p380
- Pivot pour paumelle p380
- Bolzen für Scharnier p380

R378

R378	zinc	20	6,0	3,362

Categoria commerciale: 3E



- **Cuscinetto 20x36x11 zinc. Nero per p380**
- Bearing 20x36x11 black galvanized for p380
- Roulement 20x36x11 zinc. Noir pour p380
- Lager 20x36x11 schwarz-verzinkt für p380

400

400-20	zinc nero	100	4,7	2,064

Categoria commerciale: 1E

Intuitivo, ricco e completo. Comunello.com, nuovissimo portale di facile navigazione

Intuitive, rich and complete.
Comunello.com,
brand new portal easy navigation



Ordina e descrive in maniera esauriente, chiara, fresca ed accattivante le attività del Gruppo fino al più piccolo elemento.

Order and describes in an extensive, clear, fresh and engaging activities Group to the smallest element.

COMUNELLO
GATE DIVISION

COMUNELLO
AUTOMATION

COMUNELLO
FRAME DIVISION

COMUNELLO
FRAME AUTOMATION









Life
made
easy

COMUNELLO
FRAME DIVISION

Corner Joints



LEGENDA

-  Articolo / Article
-  Misura specifica / Measure
-  Finitura / Finishing
-  Pezzi per confezione / Pieces per pack
-  Peso confezione / Weight of pack
-  Prezzo / Price
-  Su richiesta / On request
-  Cover System

900-28

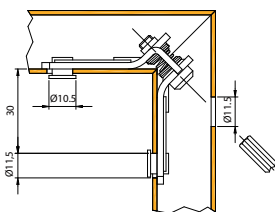

-Squadretta in acciaio zincata
 -Galvanized corner-joint
 -Equerre en acier zingué
 -Eckverbinder aus Stahl, verzinkt

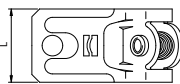

900-28	zinc	28	30	250	16,25	€ 0,629

Categoria commerciale: 5C

900-36

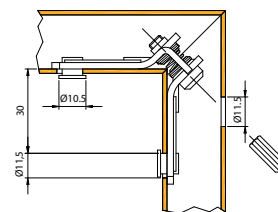

-Squadretta in acciaio zincata
 -Galvanized corner-joint
 -Equerre en acier zingué
 -Eckverbinder aus Stahl, verzinkt

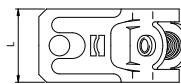

900-36	zinc	36	30	200	15,60	€ 0,692

Categoria commerciale: 5C

960-36

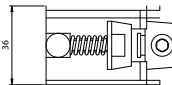
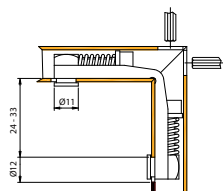

-Squadretta in acciaio zincata con tiraggio variabile
 -Galvanized corner-joint with adjustable angle
 -Equerre a angle variable en acier zingué
 -Eckverbinder mit verstellbarem Winkel aus Stahl, verzinkt

960-36	zinc	36	24-33	200	16,00	€ 2,973

Categoria commerciale: 5C

1000-40

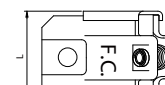
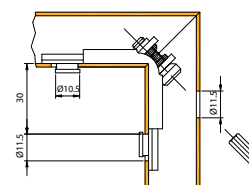

-Squadretta in acciaio zincata
 -Galvanized corner-joint
 -Equerre en acier zingué
 -Eckverbinder aus Stahl, verzinkt

1000-40	zinc	39,5	30	150	16,05	€ 1,226

Categoria commerciale: 5C

1000-45

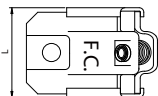
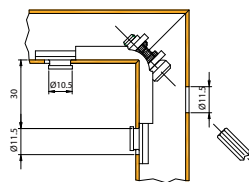

-Squadretta in acciaio zincata
 -Galvanized corner-joint
 -Equerre en acier zingué
 -Eckverbinder aus Stahl, verzinkt

1000-45	zinc	44,5	30	150	17,25	€ 1,331

Categoria commerciale: 5C

1001-36

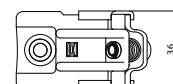
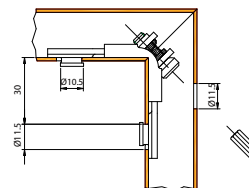

-Squadretta in acciaio zincata
 -Galvanized corner-joint
 -Equerre en acier zingué
 -Eckverbinder aus Stahl, verzinkt

1001-36	zinc	36	30	200	17,20	€ 0,714

Categoria commerciale: 5C

1020

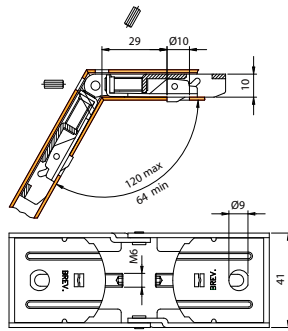

- Squadretta in acciaio ad angolo variabile
- Steel corner-joint with adjustable angle
- Equerre a angle variable en acier zingué
- Eckverbinder mit verstellbarem Winkel aus Stahl

1020	zinc	41	29	20	2,50	€ 3,353

Categoria commerciale: 5C

1051 STYNG

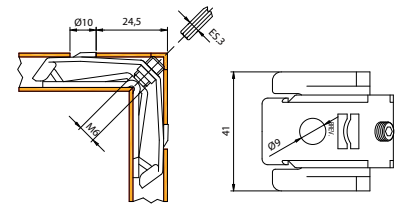

- Styng Squadretta in acciaio zincata inox - bottone tondo
- Galvanized corner-joint stainless steel
- Equerre en acier zingué
- Eckverbinder aus Stahl, verzinkt - Edelstahl

1051	zinc	41	10	24,5	250	18,00 € 0,681

Categoria commerciale: 5C

1052 STYNG

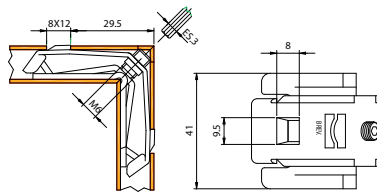

- Styng Squadretta in acciaio zincata
- Galvanized corner-joint
- Equerre en acier zingué
- Eckverbinder aus Stahl, verzinkt

1052 STYNG	zinc	41	10	29,5	250	18,00 € 0,728

Categoria commerciale: 5C

1053 STYNG

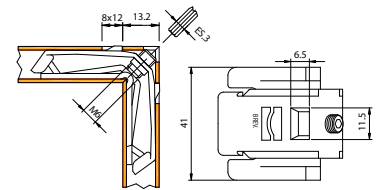

- Styng Squadretta in acciaio zincata
- Galvanized corner-joint
- Equerre en acier zingué
- Eckverbinder aus Stahl, verzinkt

1053 STYNG	zinc	41	10	13,2	250	18,00 € 0,680

Categoria commerciale: 5C

1073F - 7,5

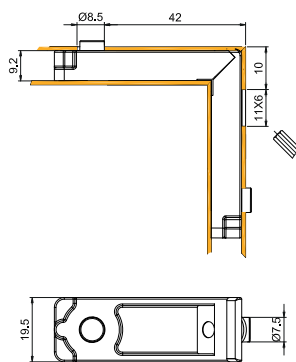

- Squadretta in alluminio filettata
- Threaded aluminium corner-joint
- Équerre aluminium fileté
- Eckverbinder aus Aluminium mit Gewinde

1073-7,5	19,5	9,2	42	250	9,75 € 0,877

Categoria commerciale: 5G

1102 - 10,5

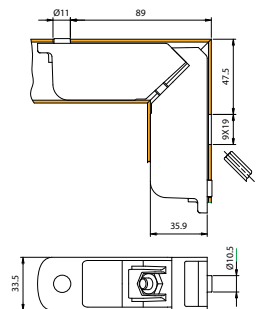

- Squadretta in alluminio con dado
- Aluminium corner-joint with nut
- Equerre aluminium à pion
- Eckverbinder aus Aluminium mit Mutter

1102-10,5	33,5	35,9	89	50	11,30 € 4,220

Categoria commerciale: 5G

1103F

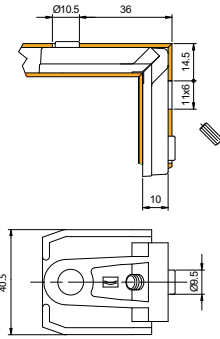

- Squadretta in alluminio filettata
- Threaded aluminium corner-joint
- Equerre aluminium fileté
- Eckverbinder aus Aluminium mit Gewinde

	L	H	F	W	A	€
1103F	40,5	10	36	250	13,00	€ 0,827
1103F - 7,5	40,5	10	36	250	13,00	€ 0,827

Categoria commerciale: 5G

1105

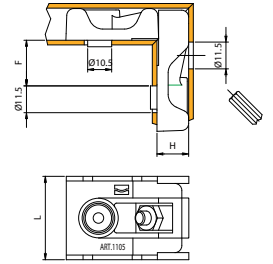

- Squadretta in alluminio con dado
- Aluminium corner-joint with nut
- Equerre aluminium à pion
- Eckverbinder aus Aluminium mit Mutter

	L	H	F	W	A	€
1105-40X18	35,8	13,9	21	250	15,00	€ 0,827
1105-45X20	40	16	24	200	13,20	€ 0,974
1105-45X30	40,4	25,2	31,5	150	16,80	€ 1,461
1105-50X20	45,5	16	24	250	16,00	€ 1,415
1105-50X25	44,9	20,6	29	200	16,60	€ 1,446
1105 GR9-40X20	35,8	13,6	22	250	16,00	€ 1,014

Categoria commerciale: 5G

1105F

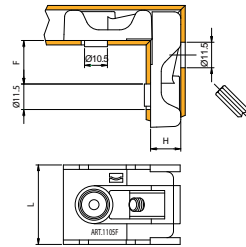

- Squadretta in alluminio filettata
- Threaded aluminium corner-joint
- Equerre aluminium fileté
- Eckverbinder aus Aluminium mit Gewinde

	L	H	F	W	A	€
1105F 40X18	35,8	13,9	21	250	15,00	€ 0,844
1105F 50X20	44,8	15,6	24	250	16,00	€ 1,415

Categoria commerciale: 5G

1106

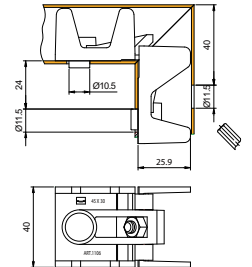

- Squadretta in alluminio con dado
- Aluminium corner-joint with nut
- Equerre aluminium à pion
- Eckverbinder aus Aluminium mit Mutter

	L	H	F	W	A	€
1106	40	25,9	40	150	12,45	€ 1,071

Categoria commerciale: 5G

1107

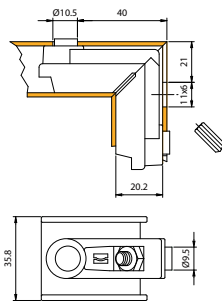

- Squadretta in alluminio con dado
- Aluminium corner-joint with nut
- Equerre aluminium à pion
- Eckverbinder aus Aluminium mit Mutter

	L	H	F	W	A	€
1107	35,8	20,2	40	250	16,00	€ 0,988

Categoria commerciale: 5G

1108

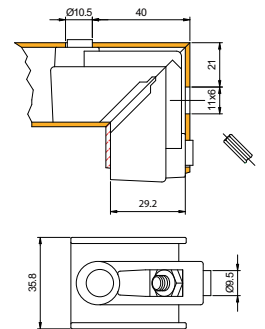

- Squadretta in alluminio con dado
- Aluminium corner-joint with nut
- Equerre aluminium à pion
- Eckverbinder aus Aluminium mit Mutter

	L	H	F	W	A	€
1108	35,8	29,2	40	200	14,60	€ 1,006

Categoria commerciale: 5G

1108F

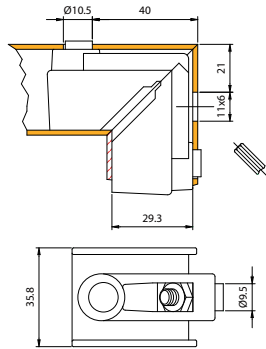

-Squadretta in alluminio filettata
-Threaded aluminium corner-joint
-Equerre aluminium fileté
-Eckverbinder aus Aluminium mit Gewinde

1108F	35,8	29,3	40	200	14,60 € 1,038

Categoria commerciale: 5G

1109F - 8,5

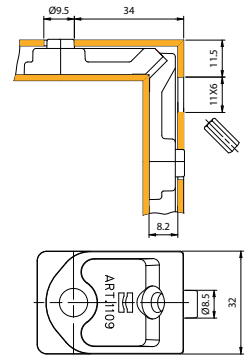

-Squadretta in alluminio filettata
-Threaded aluminium corner-joint
-Equerre aluminium fileté
-Eckverbinder aus Aluminium mit Gewinde

1109F-8,5	32	8,2	34	250	11,25 € 1,779

Categoria commerciale: 5G

1110

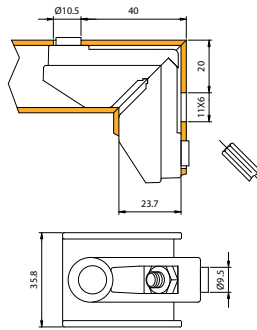

-Squadretta in alluminio con dado
-Aluminium corner-joint with nut
-Equerre aluminium à pion
-Eckverbinder aus Aluminium mit Mutter

1110	35,8	23,7	40	250	16,75 € 1,071

Categoria commerciale: 5G

1111

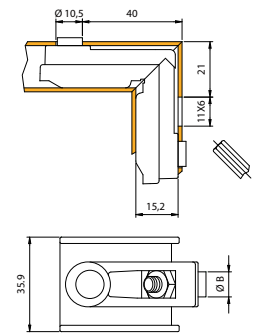

-Squadretta in alluminio con dado
-Aluminium corner-joint with nut
-Equerre aluminium à pion
-Eckverbinder aus Aluminium mit Mutter

1111	35,9	15,2	40	250	15,25 € 0,877

Categoria commerciale: 5G

1112

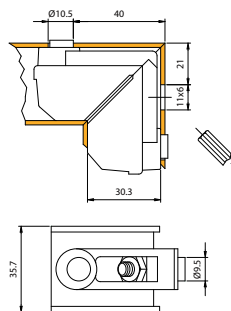

-Squadretta in alluminio con dado
-Aluminium corner-joint with nut
-Equerre aluminium à pion
-Eckverbinder aus Aluminium mit Mutter

1112	35,7	30,3	40	200	15,80 € 1,038

Categoria commerciale: 5G

1114F - 8,5

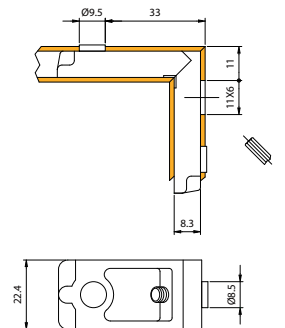

-Squadretta in alluminio filettata
-Threaded aluminium corner-joint
-Equerre aluminium fileté
-Eckverbinder aus Aluminium mit Gewinde

1114F-8,5	22,4	8,3	33	250	7,75 € 0,649

Categoria commerciale: 5G

1115F - 8,5

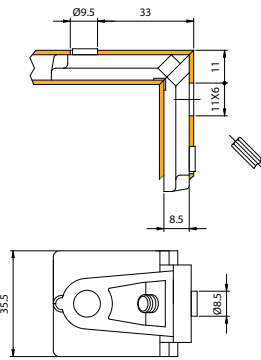

-Squadretta in alluminio filettata
 -Threaded aluminium corner-joint
 -Equerre aluminium fileté
 -Eckverbinder aus Aluminium mit Gewinde

1115F-8,5	35,5	8,5	33	250	11,00
€ 0,795					

Categoria commerciale: 5G

1116F

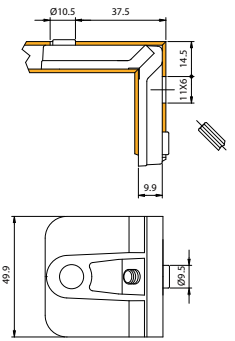

-Squadretta in alluminio filettata
 -Threaded aluminium corner-joint
 -Equerre aluminium fileté
 -Eckverbinder aus Aluminium mit Gewinde

1116F	49,9	9,3	37,5	250	13,00
€ 1,055					

Categoria commerciale: 5G

1117

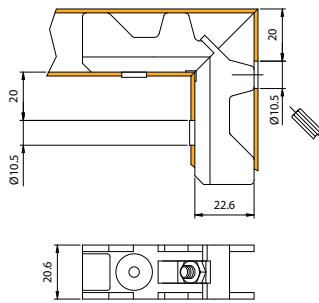

-Squadretta in alluminio con dado
 -Aluminium corner-joint with nut
 -Equerre aluminium à pion
 -Eckverbinder aus Aluminium mit Mutter

1117	20,6	22,6	20	250	15,00
€ 1,250					

Categoria commerciale: 5G

1118F

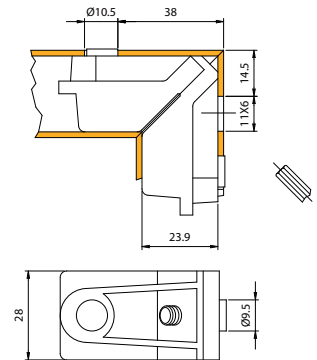

-Squadretta in alluminio filettata
 -Threaded aluminium corner-joint
 -Equerre aluminium fileté
 -Eckverbinder aus Aluminium mit Gewinde

1118F	28	23,9	38	250	14,00
€ 1,299					

Categoria commerciale: 5G

1119F

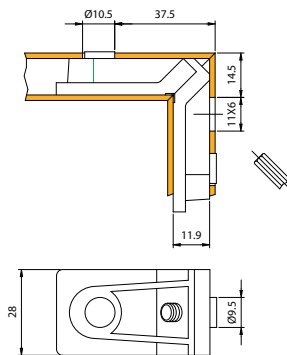

-Squadretta in alluminio filettata
 -Threaded aluminium corner-joint
 -Equerre aluminium fileté
 -Eckverbinder aus Aluminium mit Gewinde

1119F	28	11,9	37,5	250	11,00
€ 0,844					

Categoria commerciale: 5G

1120

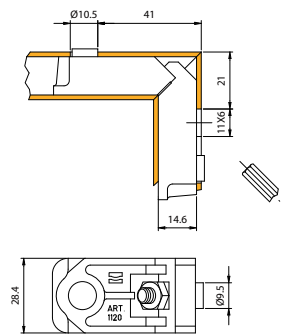

-Squadretta in alluminio con dado
 -Aluminium corner-joint with nut
 -Equerre aluminium à pion
 -Eckverbinder aus Aluminium mit Mutter

1120	28,4	14,6	41	250	15,50
€ 0,844					

Categoria commerciale: 5G

1120F

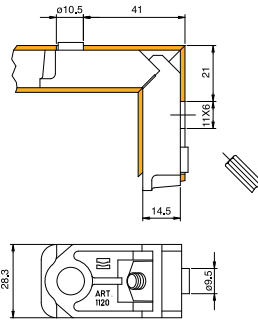

- Squadretta in alluminio filettata
- Threaded aluminium corner-joint
- Equerre aluminium fileté
- Eckverbinder aus Aluminium mit Gewinde

1120F	28,3	14,5	41	250	15,50	€ 0,877

Categoria commerciale: 5G

1121

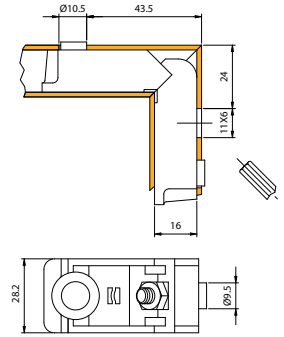

- Squadretta in alluminio con dado
- Aluminium corner-joint with nut
- Equerre aluminium à pion
- Eckverbinder aus Aluminium mit Mutter

1121	28.2	16	43,5	250	16,50	€ 1,006

Categoria commerciale: 5G

1122F

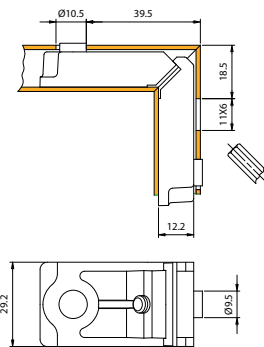

- Squadretta in alluminio filettata
- Threaded aluminium corner-joint
- Equerre aluminium fileté
- Eckverbinder aus Aluminium mit Gewinde

1122F	29,2	12,2	39,5	250	15,25	€ 1,062

Categoria commerciale: 5G

1123F - 7,5

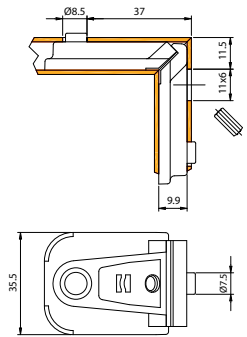

- Squadretta in alluminio filettata
- Threaded aluminium corner-joint
- Equerre aluminium fileté
- Eckverbinder aus Aluminium mit Gewinde

1123F - 7,5	35,5	9,9	37	250	15,00	€ 1,299

Categoria commerciale: 5G

1124

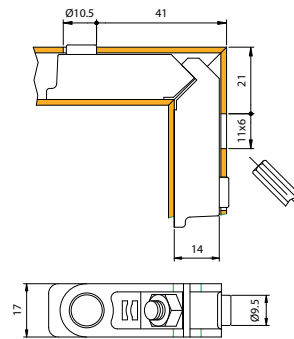

- Squadretta in alluminio con dado
- Aluminium corner-joint with nut
- Equerre aluminium à pion
- Eckverbinder aus Aluminium mit Mutter

1124	17	14	41	250	11,75	€ 0,747

Categoria commerciale: 5G

1125

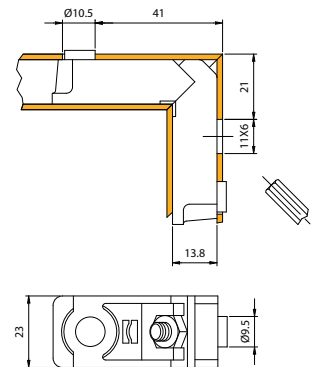

- Squadretta in alluminio con dado
- Aluminium corner-joint with nut
- Equerre aluminium à pion
- Eckverbinder aus Aluminium mit Mutter

1125	23	13,8	41	250	14,00	€ 0,779

Categoria commerciale: 5G

1125F

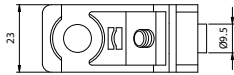
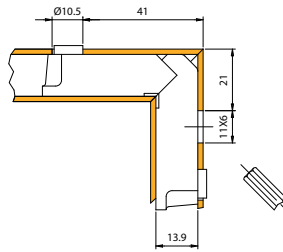

- Squadretta in alluminio filettata
- Threaded aluminium corner-joint
- Equerre aluminium fileté
- Eckverbinder aus Aluminium mit Gewinde

1125F	23	13,9	41	250	14,00
€ 0,812					

Categoria commerciale: 5G

1126F - 8,5

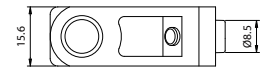
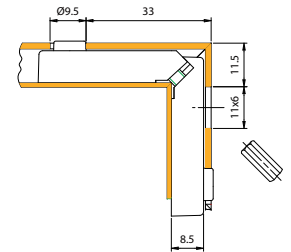

- Squadretta in alluminio filettata
- Threaded aluminium corner-joint
- Equerre aluminium fileté
- Eckverbinder aus Aluminium mit Gewinde

1126F - 8,5	15,6	8,5	33	250	6,00
€ 0,844					

Categoria commerciale: 5G

1127

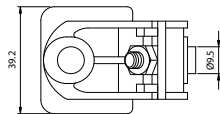
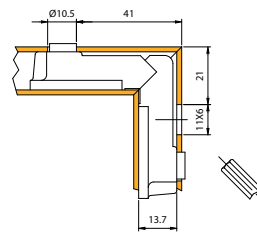

- Squadretta in alluminio con dado
- Aluminium corner-joint with nut
- Equerre aluminium à pion
- Eckverbinder aus Aluminium mit Mutter

1127	39,2	13,7	41	200	15,00
€ 1,266					

Categoria commerciale: 5G

1128

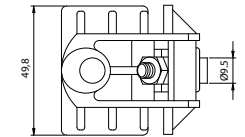
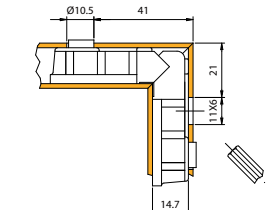

- Squadretta in alluminio con dado
- Aluminium corner-joint with nut
- Equerre aluminium à pion
- Eckverbinder aus Aluminium mit Mutter

1128	49,8	14,7	41	200	17,60
€ 1,482					

Categoria commerciale: 5G

1129F

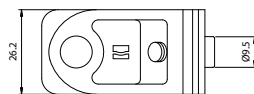
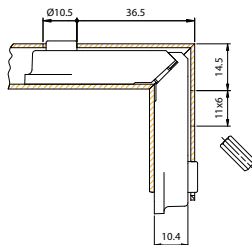

- Squadretta in alluminio filettata
- Threaded aluminium corner-joint
- Equerre aluminium fileté
- Eckverbinder aus Aluminium mit Gewinde

1129F	26,2	10,4	36,5	250	11,00
€ 0,714					

Categoria commerciale: 5G

1130

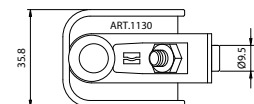
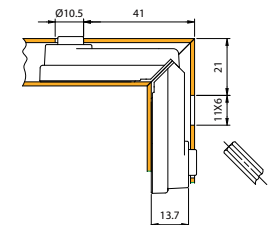

- Squadretta in alluminio con dado
- Aluminium corner-joint with nut
- Equerre aluminium à pion
- Eckverbinder aus Aluminium mit Mutter

1130	35,8	13,7	41	250	15,50
€ 0,942					

1130 - 7,5

Categoria commerciale: 5G

1130V

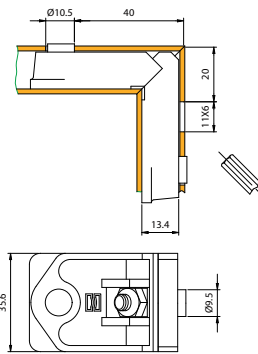

- Squadretta in alluminio con dado
- Aluminium corner-joint with nut
- Équerre aluminium à pion
- Eckverbinder aus Aluminium mit Mutter

1130V	35,6	13,4	40	250	17,75	€ 0,812

Categoria commerciale: 5G

1131F

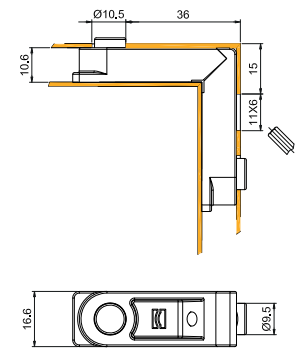

- Squadretta in alluminio filettata
- Threaded aluminium corner-joint
- Équerre aluminium fileté
- Eckverbinder aus Aluminium mit Gewinde

1131F	16,6	10,6	36	250	9,75	€ 0,656

Categoria commerciale: 5G

1132

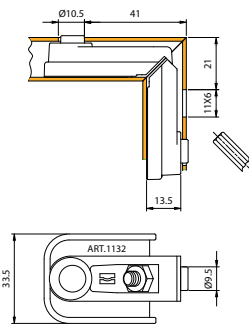

- Squadretta in alluminio con dado
- Aluminium corner-joint with nut
- Équerre aluminium à pion
- Eckverbinder aus Aluminium mit Mutter

1132	33,5	13,5	41	250	14,00	€ 1,234

Categoria commerciale: 5G

1133F - 7,5

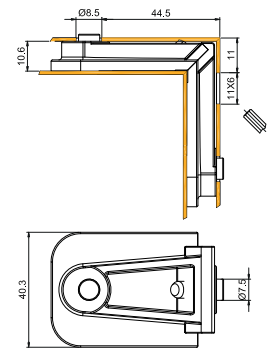

- Squadretta in alluminio filettata
- Threaded aluminium corner-joint
- Équerre aluminium fileté
- Eckverbinder aus Aluminium mit Gewinde

1133F-7,5	40,3	10,6	44,5	250	16,75	€ 1,059

Categoria commerciale: 5G

1134F

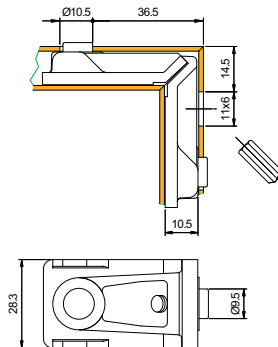

- Squadretta in alluminio filettata
- Threaded aluminium corner-joint
- Équerre aluminium fileté
- Eckverbinder aus Aluminium mit Gewinde

1134F	28,3	10,5	36,5	250	11,50	€ 0,779

Categoria commerciale: 5G

1135F

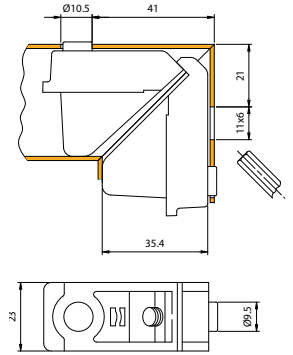

- Squadretta in alluminio filettata
- Threaded aluminium corner-joint
- Équerre aluminium fileté
- Eckverbinder aus Aluminium mit Gewinde

1135F	23	35,4	41	250	16,75	€ 1,266

Categoria commerciale: 5G

1136F

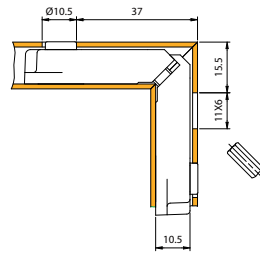

- Squadretta in alluminio filettata
- Threaded aluminium corner-joint
- Equerre aluminium fileté
- Eckverbinder aus Aluminium mit Gewinde

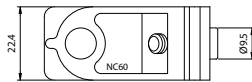

1136F	22,4	10,5	37	250	9,25	€ 0,714
1136F - 7,5	22,4	10,5	37	250	9,00	€ 0,875

Categoria commerciale: 5G

1137

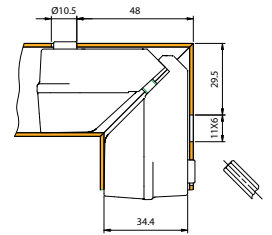

- Squadretta in alluminio con dado
- Aluminium corner-joint with nut
- Equerre aluminium à pion
- Eckverbinder aus Aluminium mit Mutter

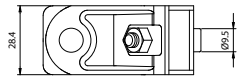

1137	28,4	34,4	48	150	15,90	€ 1,526
Categoria commerciale: 5G						

1138F

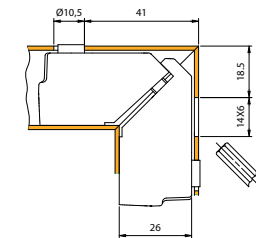

- Squadretta in alluminio filettata
- Threaded aluminium corner-joint
- Equerre aluminium fileté
- Eckverbinder aus Aluminium mit Gewinde

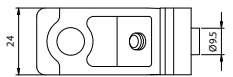

1138F	24	26	41	250	17,75	€ 1,136
Categoria commerciale: 5G						

1139 - 7,5

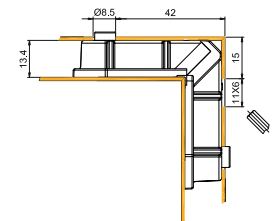

- Squadretta in alluminio con dado
- Aluminium corner-joint with nut
- Équerre aluminium à pion
- Eckverbinder aus Aluminium mit Mutter

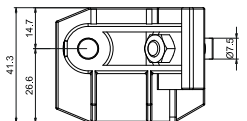

1139	41,3	13,4	42	250	17,50	€ 0,916
Categoria commerciale: 5G						

1140

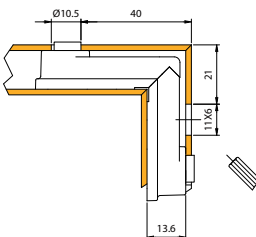

- Squadretta in alluminio con dado
- Aluminium corner-joint with nut
- Equerre aluminium à pion
- Eckverbinder aus Aluminium mit Mutter

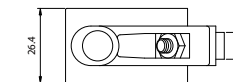

1140	26,4	13,6	40	250	11,50	€ 0,910
Categoria commerciale: 5G						

1141

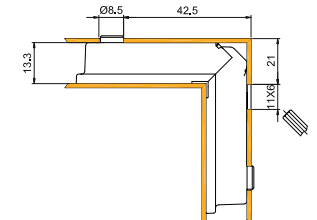

- Squadretta in alluminio con dado
- Aluminium corner-joint with nut
- Équerre aluminium à pion
- Eckverbinder aus Aluminium mit Mutter

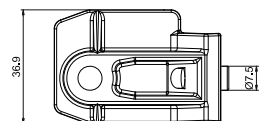

1141	36,9	13,3	42,5	250	16,5	€ 1,323
Categoria commerciale: 5G						

1142F

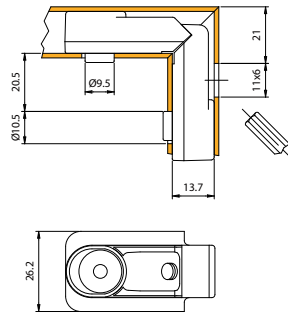

-Squadretta in alluminio filettata
-Threaded aluminium corner-joint
-Equerre aluminium fileté
-Eckverbinder aus Aluminium mit Gewinde

1142F	26,2	13,7	20,5	250	11,00	€ 0,882

Categoria commerciale: 5G

1143F

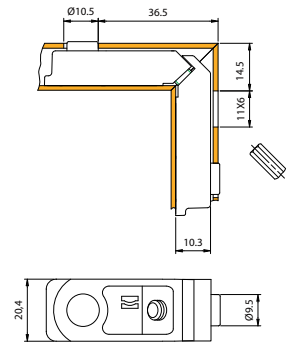

-Squadretta in alluminio filettata
-Threaded aluminium corner-joint
-Equerre aluminium fileté
-Eckverbinder aus Aluminium mit Gewinde

1143F	20,4	10,3	36,5	250	8,00	€ 0,714

Categoria commerciale: 5G

1144

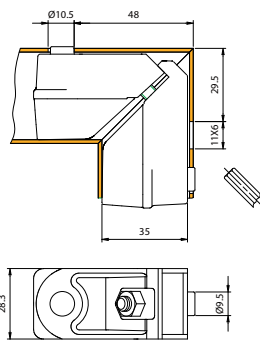

-Squadretta in alluminio con dado
-Aluminium corner-joint with nut
-Equerre aluminium à pion
-Eckverbinder aus Aluminium mit Mutter

1144	28,3	35	48	150	15,90	€ 1,915

Categoria commerciale: 5G

1145F

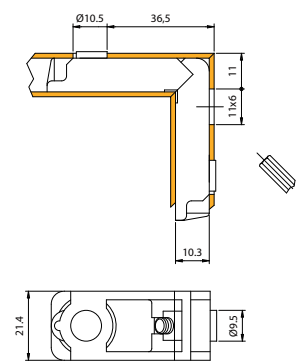

-Squadretta in alluminio filettata
-Threaded aluminium corner-joint
-Equerre aluminium fileté
-Eckverbinder aus Aluminium mit Gewinde

1145F	21,4	10,3	36,5	250	9,50	€ 0,750

Categoria commerciale: 5G

1146

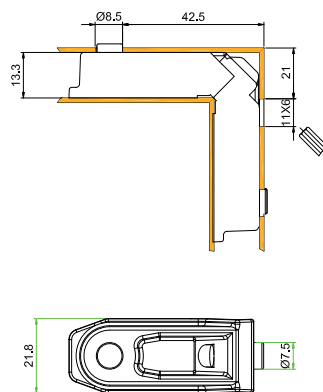

-Squadretta in alluminio con dado
-Aluminium corner-joint with nut
-Équerre aluminium à pion
-Eckverbinder aus Aluminium mit Mutter

1146	21,8	13,3	42,5	250	12,75	€ 1,103

Categoria commerciale: 5G

1147

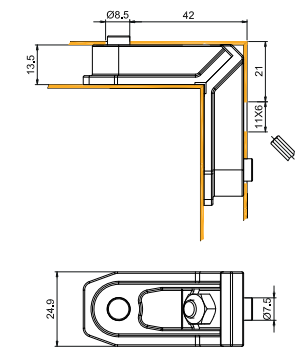

-Squadretta in alluminio con dado
-Aluminium corner-joint with nut
-Équerre aluminium à pion
-Eckverbinder aus Aluminium mit Mutter

1147	24,9	13,5	42	250	13,0	€ 0,735

Categoria commerciale: 5G

1148F

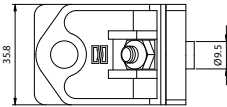
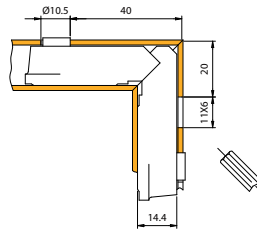

-Squadretta in alluminio filettata
 -Threaded aluminium corner-joint
 -Equerre aluminium fileté
 -Eckverbinder aus Aluminium mit Gewinder

1148F LEGGERA	35,7	14,4	41	250	15,50	€ 0,877
1148F PESANTE	35,9	14,4	40	200	18,00	€ 1,131

Categoria commerciale: 5G

1148

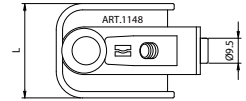
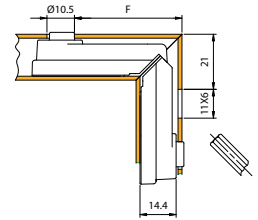

-Squadretta in alluminio con dado
 -Aluminium corner-joint with nut
 -Equerre aluminium à pion
 -Eckverbinder aus Aluminium mit Mutter

1148 PESANTE	35,8	14,4	40	200	13,80	€ 0,942

Categoria commerciale: 5G

1155

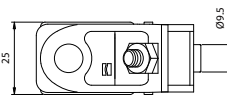
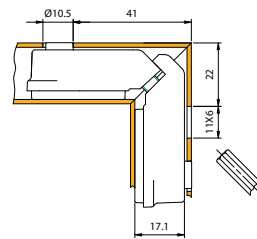

-Squadretta in alluminio con dado
 -Aluminium corner-joint with nut
 -Equerre aluminium à pion
 -Eckverbinder aus Aluminium mit Mutter

1155	25	17,1	41	250	15,50	€ 0,893

Categoria commerciale: 5G

1155F

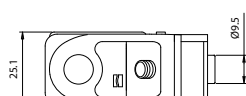
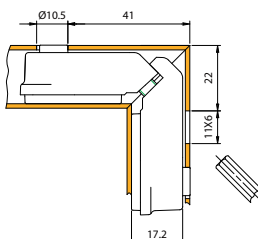

-Squadretta in alluminio filettata
 -Threaded aluminium corner-joint
 -Equerre aluminium fileté
 -Eckverbinder aus Aluminium mit Gewinde

1155F	25,1	17,2	41	250	15,50	€ 0,925

Categoria commerciale: 5G

1156-7,5

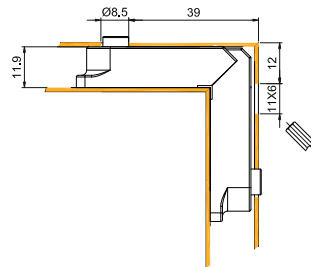

Squadretta in alluminio con dado
 Aluminium corner-joint with nut
 Équerre aluminium à pion
 Eckverbinder aus Aluminium mit Mutter

1156	13,7	11,9	39	250	8,0	€ 0,815

Categoria commerciale: 5G

1157

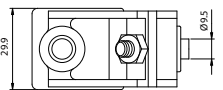
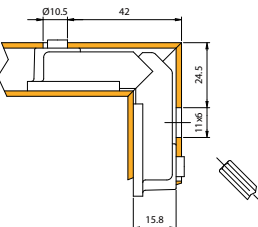

-Squadretta in alluminio con dado
 -Aluminium corner-joint with nut
 -Equerre aluminium à pion
 -Eckverbinder aus Aluminium mit Mutter

1157	29,9	15,8	42	250	16,75	€ 1,428

Categoria commerciale: 5G

1159

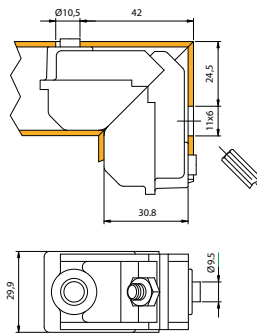

- Squadretta in alluminio con dado
- Aluminium corner-joint with nut
- Equerre aluminium à pion
- Eckverbinder aus Aluminium mit Mutter

1159	29,9	30,8	42	250	20,25	€ 1,163

Categoria commerciale: 5G

1160F

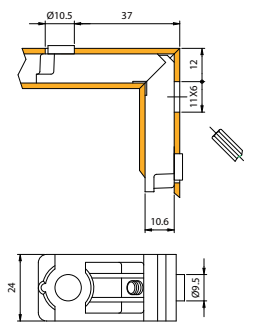

- Squadretta in alluminio filettata
- Threaded aluminium corner-joint
- Equerre aluminium fileté
- Eckverbinder aus Aluminium mit Gewinde

1160F	24	10,6	37	250	11,50	€ 0,714

Categoria commerciale: 5G

1161F

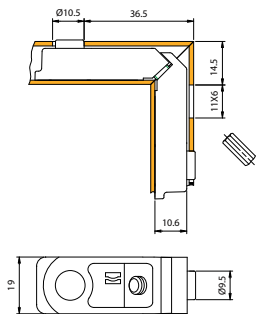

- Squadretta in alluminio filettata
- Threaded aluminium corner-joint
- Equerre aluminium fileté
- Eckverbinder aus Aluminium mit Gewinde

1161F	19	10,6	36,5	250	9,00	€ 0,714

Categoria commerciale: 5G

1163F

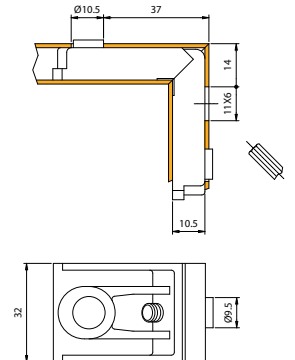

- Squadretta in alluminio filettata
- Threaded aluminium corner-joint
- Equerre aluminium fileté
- Eckverbinder aus Aluminium mit Gewinde

1163F	32	10,5	37	200	11,20	€ 0,860

Categoria commerciale: 5G

1164F

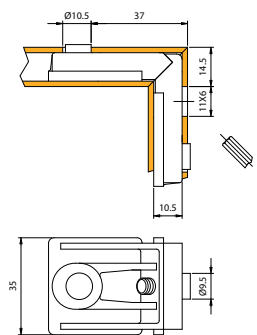

- Squadretta in alluminio filettata
- Threaded aluminium corner-joint
- Equerre aluminium fileté
- Eckverbinder aus Aluminium mit Gewinde

1164F	35	10,5	37	250	11,75	€ 0,974

1164F - 7,5	35	10,5	37	250	11,75	€ 0,841
--------------------	----	------	----	-----	-------	---------

Categoria commerciale: 5G

1165F

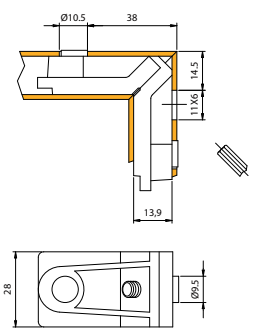

- Squadretta in alluminio filettata
- Threaded aluminium corner-joint
- Equerre aluminium fileté
- Eckverbinder aus Aluminium mit Gewinde

1165F	28	13,9	38	250	12,00	€ 0,843

Categoria commerciale: 5G

1166

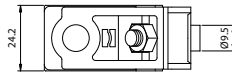
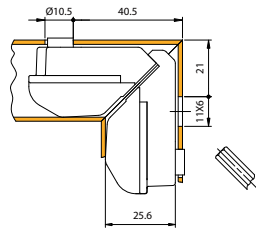

-Squadretta in alluminio con dado
 -Aluminium corner-joint with nut
 -Equerre aluminium à pion
 -Eckverbinder aus Aluminium mit Mutter

1166	24,2	25,6	40,5	250	17,25	€ 1,006

Categoria commerciale: 5G

1167

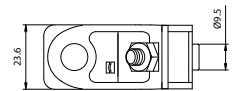
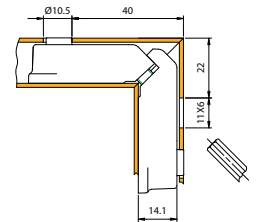

-Squadretta in alluminio con dado
 -Aluminium corner-joint with nut
 -Equerre aluminium à pion
 -Eckverbinder aus Aluminium mit Mutter

1167	23,6	14,1	40	250	14,25	€ 0,779

Categoria commerciale: 5G

1167F

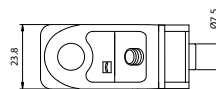
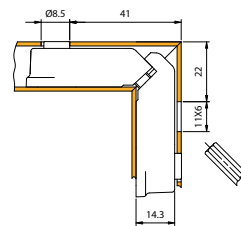

-Squadretta in alluminio filettata
 -Threaded aluminium corner-joint
 -Equerre aluminium fileté
 -Eckverbinder aus Aluminium mit Gewinde

1167F	23,8	14,3	40	250	14,00	€ 1,027
1167F - 7,5	23,8	14,3	41	250	14,00	€ 0,812
1167F - 7,5 - 9,5	23,6	14,1	40	250	14,25	€ 0,791

Categoria commerciale: 5G

1168F

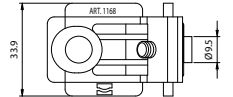
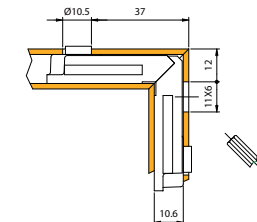

-Squadretta in alluminio con dado
 -Aluminium corner-joint with nut
 -Equerre aluminium à pion
 -Eckverbinder aus Aluminium mit Mutter

1168F	33,9	10,6	37	250	12,50	€ 0,747

Categoria commerciale: 5G

1169

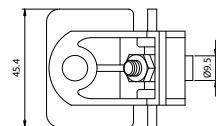
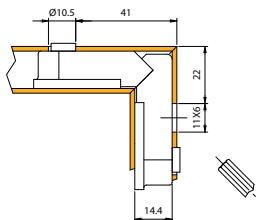

-Squadretta in alluminio con dado
 -Aluminium corner-joint with nut
 -Equerre aluminium à pion
 -Eckverbinder aus Aluminium mit Mutter

1169	45,4	14,4	41	200	16,20	€ 1,299

Categoria commerciale: 5G

1170F

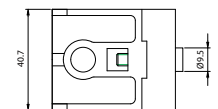
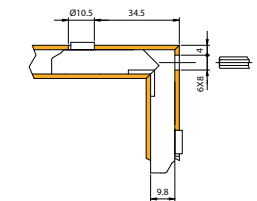

-Squadretta in alluminio filettata
 -Threaded aluminium corner-joint
 -Equerre aluminium fileté
 -Eckverbinder aus Aluminium mit Gewinde

1170F	40,7	9,8	34,5	250	16,50	€ 1,201

Categoria commerciale: 5G

1172

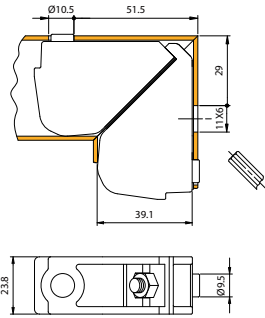

- Squadretta in alluminio con dado
- Aluminium corner-joint with nut
- Equerre aluminium à pion
- Eckverbinder aus Aluminium mit Mutter

1172	23,8	39,1	51,5	150	8,40 € 1,461

Categoria commerciale: 5G

1173F

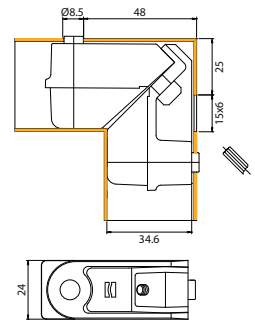

- Squadretta in alluminio filettata
- Threaded aluminium corner-joint
- Equerre aluminium fileté
- Eckverbinder aus Aluminium mit Gewinde

1173F - 7,5	24	34,6	48	250	22,50 € 1,377
1173F - 9,5	24	44,6	47	250	22,50 € 1,377

Categoria commerciale: 5G

1175

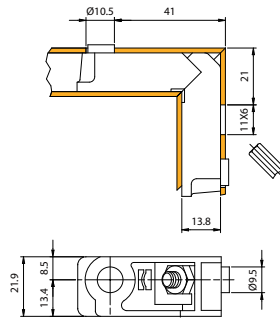

- Squadretta in alluminio con dado
- Aluminium corner-joint with nut
- Equerre aluminium à pion
- Eckverbinder aus Aluminium mit Mutter

1175	21,9	13,8	41	250	13,00 € 1,364

Categoria commerciale: 5G

1176

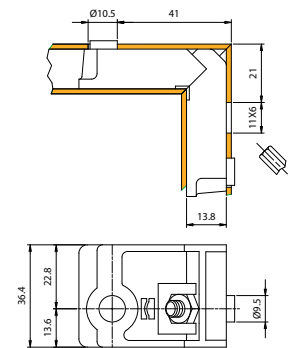

- Squadretta in alluminio con dado
- Aluminium corner-joint with nut
- Equerre aluminium à pion
- Eckverbinder aus Aluminium mit Mutter

1176	36,4	13,8	41	250	18,75 € 1,266

Categoria commerciale: 5G

1177F (dx-sx)

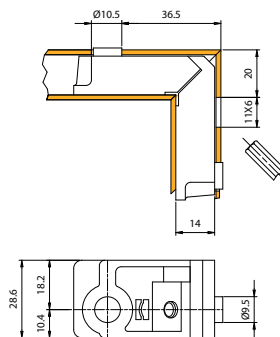

- Squadretta in alluminio filettata dx e sx
- Threaded aluminium corner-joint
- Equerre aluminium fileté droite et gauche
- Eckverbinder aus Aluminium mit Gewinde rechts und links

1177F (DX-SX)	28,6	14	36,5	200 (100dx+100sx)	22,00 € 1,754

Categoria commerciale: 5G

1178F

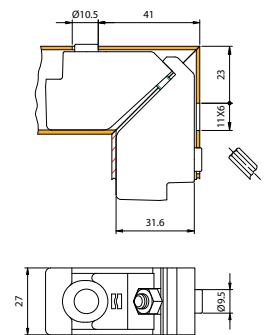

- Squadretta in alluminio filettata
- Threaded aluminium corner-joint
- Equerre aluminium fileté
- Eckverbinder aus Aluminium mit Gewinde

1178F	27	31,6	41	150	11,70 € 1,299

Categoria commerciale: 5G

1179F

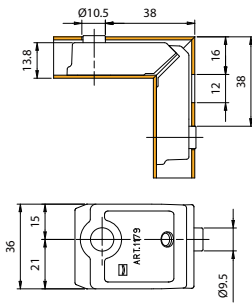

- Squadretta in alluminio filettata
- Threaded aluminium corner-joint
- Equerre aluminium fileté
- Eckverbinder aus Aluminium mit Gewinde

1179F	36	13,8	38	250	17,75	€ 1,136

Categoria commerciale: 5G

1180

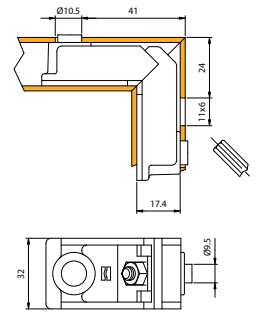

- Squadretta in alluminio con dado
- Aluminium corner-joint with nut
- Equerre aluminium à pion
- Eckverbinder aus Aluminium mit Mutter

1180	32	17,4	41	250	18,00	€ 0,974

Categoria commerciale: 5G

1180F

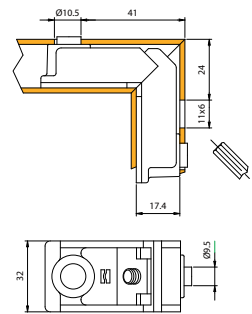

- Squadretta in alluminio filettata
- Threaded aluminium corner-joint
- Equerre aluminium fileté
- Eckverbinder aus Aluminium mit Gewinde

1180F	32	17,4	41	250	18,00	€ 1,006

Categoria commerciale: 5G

1181F

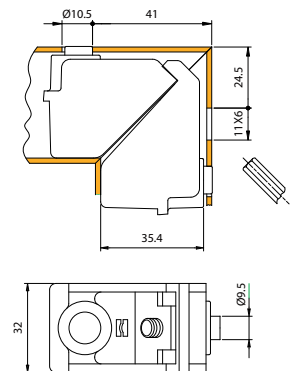

- Squadretta in alluminio filettata
- Threaded aluminium corner-joint
- Equerre aluminium fileté
- Eckverbinder aus Aluminium mit Gewinde

1181F	32	35,4	41	250	21,50	€ 1,461

Categoria commerciale: 5G

1182 1182-7,5-9,5

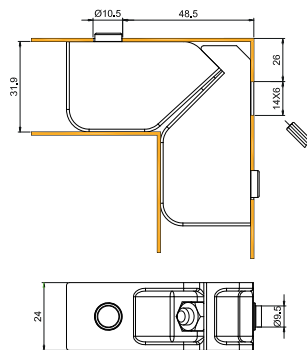

- Squadretta in alluminio con dado
- Aluminium corner-joint with nut
- Equerre aluminium à pion
- Eckverbinder aus Aluminium mit Mutter

1182	24	31,9	48,5	200	20,40	€ 1,658
1182 - 7,5 - 9,5	24	31,9	48,5	150	15,30	€ 1,870

Categoria commerciale: 5G

1183

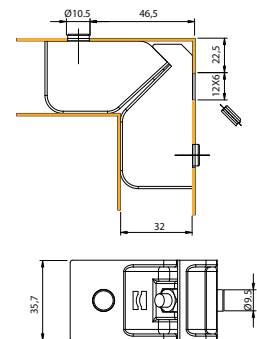

- Squadretta in alluminio con dado
- Aluminium corner-joint with nut
- Equerre aluminium à pion
- Eckverbinder aus Aluminium mit Mutter

1183	35,7	32	46,5	150	18,30	€ 1,830

Categoria commerciale: 5G

1184

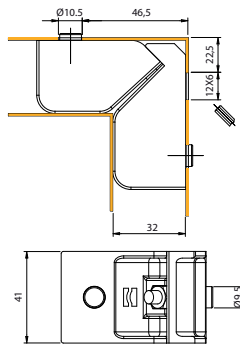

- Squadretta in alluminio con dado
- Aluminium corner-joint with nut
- Equerre aluminium à pion
- Eckverbinder aus Aluminium mit Mutter

1184	41	32	46,5	100	13,30	€ 1,884

Categoria commerciale: 5G

1186

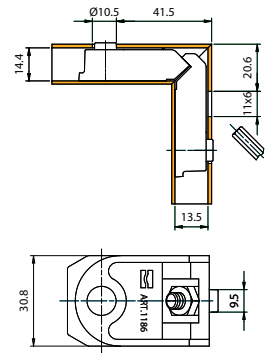

- Squadretta in alluminio con dado
- Aluminium corner-joint with nut
- Equerre aluminium à pion
- Eckverbinder aus Aluminium mit Mutter

1186	30,8	13,5	41,5	250	16,50	€ 1,136

Categoria commerciale: 5G

1187F - 7,5

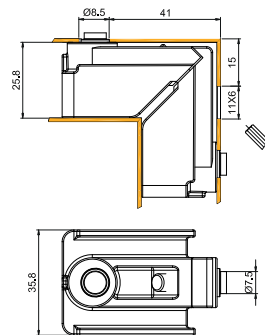

- Squadretta in alluminio filettata
- Threaded aluminium corner-joint
- Équerre aluminium fileté
- Eckverbinder aus Aluminium mit Gewinde

1187F-7,5	35,8	25,8	38	250	18,50	€ 1,153

Categoria commerciale: 5G

1190F

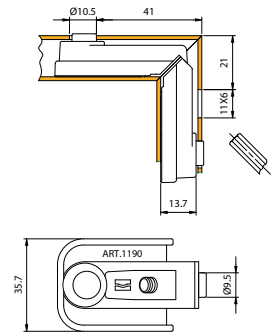

- Squadretta in alluminio filettata
- Threaded aluminium corner-joint
- Equerre aluminium fileté
- Eckverbinder aus Aluminium mit Gewinde

1190F	35,7	13,7	41	250	15,00	0,804

Categoria commerciale: 5G

1191

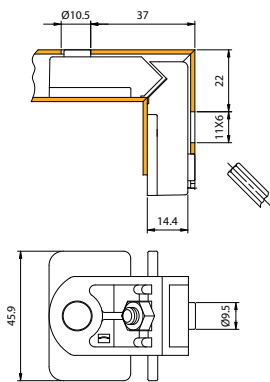

- Squadretta in alluminio con dado
- Aluminium corner-joint with nut
- Equerre aluminium à pion
- Eckverbinder aus Aluminium mit Mutter

1191	45,9	14,4	37	250	19,25	€ 1,234

Categoria commerciale: 5G

1192

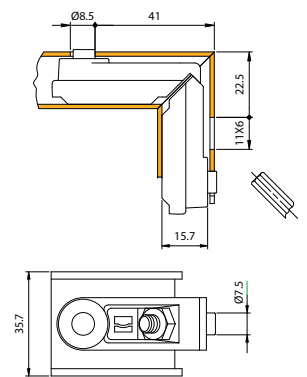

- Squadretta in alluminio con dado
- Aluminium corner-joint with nut
- Equerre aluminium à pion
- Eckverbinder aus Aluminium mit Mutter

1192	35,7	15,7	41	250	16,00	€ 0,942

Categoria commerciale: 5G

1193F

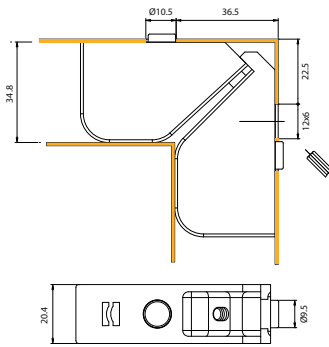

- Squadretta in alluminio filettata
- Threaded aluminium corner-joint
- Equerre aluminium fileté
- Eckverbinder aus Aluminium mit Gewinde

1193F	20,4	34,8	36,5	250	21,00	€ 3,276

Categoria commerciale: 5G

1194F

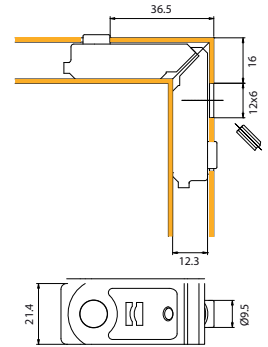

- Squadretta in alluminio filettata
- Threaded aluminium corner-joint
- Equerre aluminium fileté
- Eckverbinder aus Aluminium mit Gewinde

1194F	21,4	12,3	36,5	250	13,00	€ 1,028

Categoria commerciale: 5G

1196

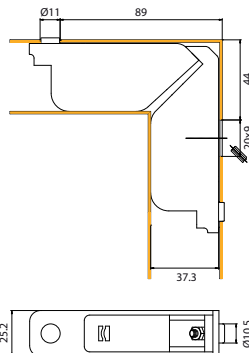

- Squadretta in alluminio con dado
- Aluminium corner-joint with nut
- Equerre aluminium à pion
- Eckverbinder aus Aluminium mit Mutter

1196	25,2	37,3	89	50	8,80	€ 3,061

Categoria commerciale: 5G

1197

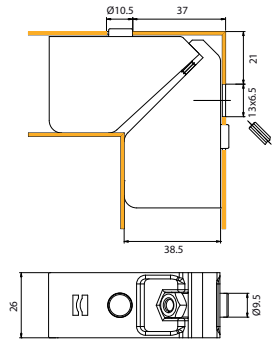

- Squadretta in alluminio con dado
- Aluminium corner-joint with nut
- Equerre aluminium à pion
- Eckverbinder aus Aluminium mit Mutter

1197	26	38,5	37	150	18,00	€ 1,686

Categoria commerciale: 5G

1198F

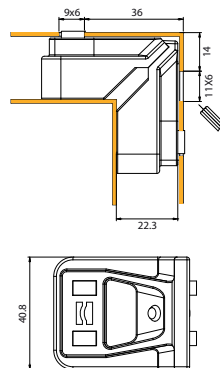

- Squadretta in alluminio filettata
- Threaded aluminium corner-joint
- Equerre aluminium fileté
- Eckverbinder aus Aluminium mit Gewinde

1198F	40,8	22,3	36	200	18,20	€ 1,584

Categoria commerciale: 5G

1199F

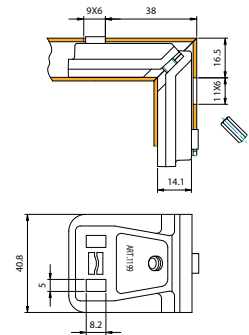

- Squadretta in alluminio filettata
- Threaded aluminium corner-joint
- Equerre aluminium fileté
- Eckverbinder aus Aluminium mit Gewinde

1199F	40,8	14,1	38	200	18,80	€ 1,299

Categoria commerciale: 5G

1301 sx 1301 dx

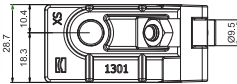
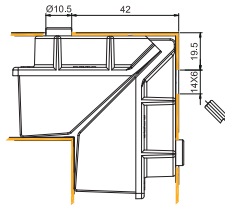

-Squadretta in alluminio con dado
-Aluminium corner-joint with nut
-Équerre aluminium à pion
-Eckverbinder aus Aluminium mit Mutter

	L	H	F	Ø	Ø	€
1301 dx	28,7	37,5	42	150	13,50	€ 1,226
1301 sx	28,7	37,5	42	150	13,50	€ 1,226

Categoria commerciale: 5G

1302

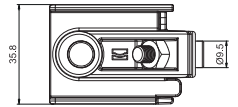
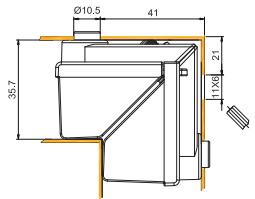

-Squadretta in alluminio con dado
-Aluminium corner-joint with nut
-Équerre aluminium à pion
-Eckverbinder aus Aluminium mit Mutter

	L	H	F	Ø	Ø	€
1302	35,8	35,7	41	150	11,25	€ 1,234

Categoria commerciale: 5G

1303 1303 - 7,5

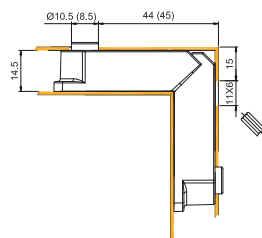

-Squadretta in alluminio con dado
-Aluminium corner-joint with nut
-Équerre aluminium à pion
-Eckverbinder aus Aluminium mit Mutter

	L	H	F	Ø	Ø	€
1303	19,5	14,5	44	250	13,50	€ 0,779
1303-7,5	19,5	14,5	45	250	13,50	€ 0,797

Categoria commerciale: 5G

1304 - 7,5

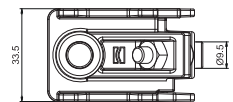
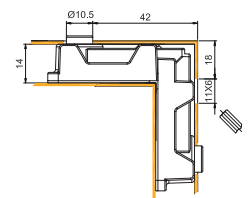

-Squadretta in alluminio con dado
-Aluminium corner-joint with nut
-Équerre aluminium à pion
-Eckverbinder aus Aluminium mit Mutter

	L	H	F	Ø	Ø	€
1304-7,5	33,5	14	42	250	16,50	€ 1,428

Categoria commerciale: 5G

1305F

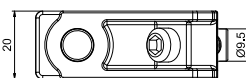
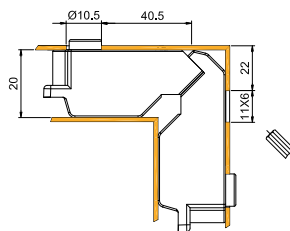

-Squadretta in alluminio filettata
-Threaded aluminium corner-joint
-Équerre aluminium fileté
-Eckverbinder aus Aluminium mit Gewinde

	L	H	D	Ø	Ø	€
1305F (A536F)	20	20	40,5	250	12,50	€ 0,924

Categoria commerciale: 5G

1306

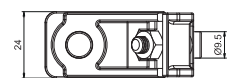
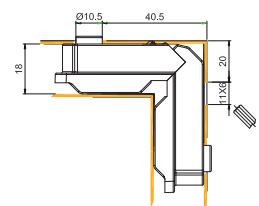

-Squadretta in alluminio con dado
-Aluminium corner-joint with nut
-Équerre aluminium à pion
-Eckverbinder aus Aluminium mit Mutter

	L	H	F	Ø	Ø	€
1306 (A537)	24	18	40,5	250	14,25	€ 1,192

Categoria commerciale: 5G

1307

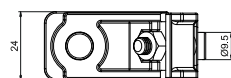
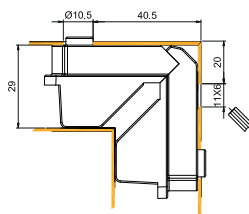

-Squadretta in alluminio con dado

- Aluminium corner-joint with nut
- Équerre aluminium à pion
- Eckverbinder aus Aluminium mit Mutter

1307 (A538)	24	29	40,5	250	15,50	€ 1,403

Categoria commerciale: 5G

1308

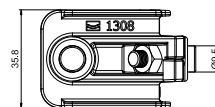
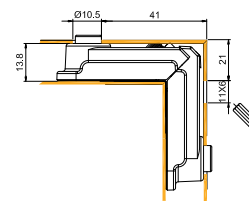

-Squadretta in alluminio con dado

- Aluminium corner-joint with nut
- Équerre aluminium à pion
- Eckverbinder aus Aluminium mit Mutter

1308	35,8	13,8	41	250	15,5	€ 0,83

Categoria commerciale: 5G

1309

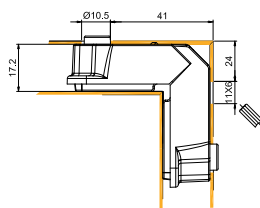

-Squadretta in alluminio con dado

- Aluminium corner-joint with nut
- Équerre aluminium à pion
- Eckverbinder aus Aluminium mit Mutter

1309	31,6	17,2	41	250	18,00	€ 0,846

Categoria commerciale: 5G

1580



-Squadretta di allineamento pressofusa con eccentrici

- Die-cast aligning corner-joint with grip eccentrics
- Équerre en aluminium pressé avec systèmes d'ancrage excentrique
- Druckgegusste Ausrichtungswinkel mit Exzenterscheibe

AKTIVA
PATENTED

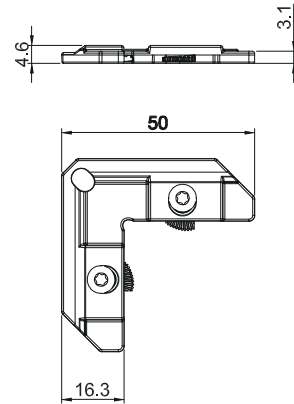

	L	H	W	Wt	€
1580 AKTIVA	4,6	16,3	250	3,00	€ 0,739
Categoria commerciale: 5G					

1581



-Squadretta di allineamento pressofusa con eccentrici

- Die-cast aligning corner-joint with grip eccentrics
- Équerre en aluminium pressé avec systèmes d'ancrage excentrique
- Druckgegusste Ausrichtungswinkel mit Exzenterscheibe

AKTIVA
PATENTED

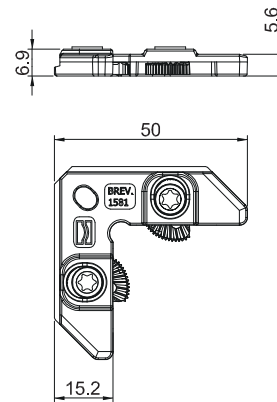

	L	H	W	Wt	€
1581 AKTIVA	6,9	15,2	250	4,0	€ 0,684
Categoria commerciale: 5G					

1582



-Squadretta di allineamento pressofusa con eccentrici

- Die-cast, aligning corner joint with grip eccentrics
- Équerre en aluminium pressé avec systèmes d'ancrage excentrique
- Druckgegusste Ausrichtungswinkel mit Exzenterscheibe

AKTIVA
PATENTED

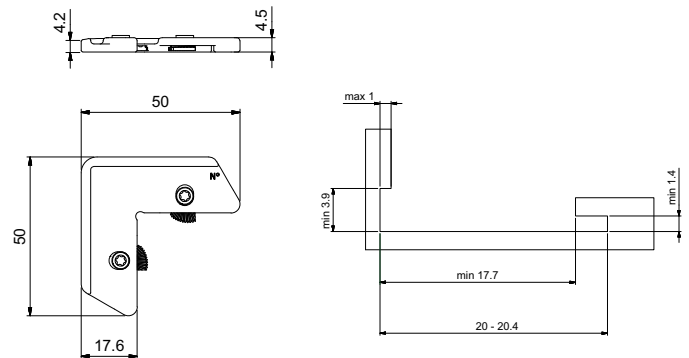

	L	H	W	Wt	€
1582 AKTIVA	4,5	17,6	250	3,25	€ 0,568
Categoria commerciale: 5G					

1583



-Squadretta di allineamento pressofusa con eccentrici

- Die-cast aligning corner-joint with grip eccentrics
- Équerre en aluminium pressé avec systèmes d'ancrage excentrique
- Druckgegusster Ausrichtungswinkel mit Exzenterscheibe

AKTIVA
PATENTED

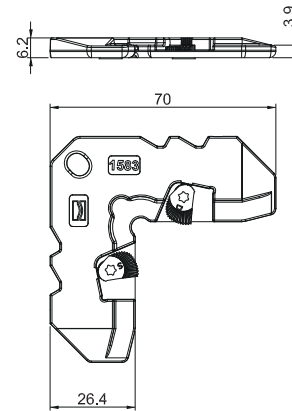

	6.2	26.4	250	7,75	€ 0,696
Categoria commerciale: 5G					

1584



-Squadretta di allineamento pressofusa con eccentrici

- Die-cast aligning corner-joint with grip eccentrics
- Équerre en aluminium pressé avec systèmes d'ancrage excentrique
- Druckgegusster Ausrichtungswinkel mit Exzenterscheibe

AKTIVA
PATENTED

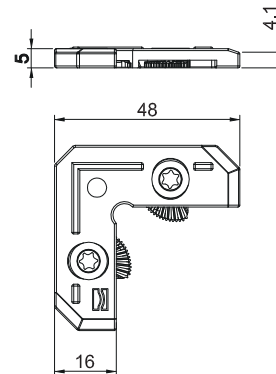

	5	16	250	4,0	€ 0,637
Categoria commerciale: 5G					

1585



-Squadretta di allineamento pressofusa con eccentrici

- Die-cast aligning corner-joint with grip eccentrics
- Équerre en aluminium pressé avec systèmes d'ancrage excentrique
- Druckgegusster Ausrichtungswinkel mit Exzenterscheibe

AKTIVA
PATENTED

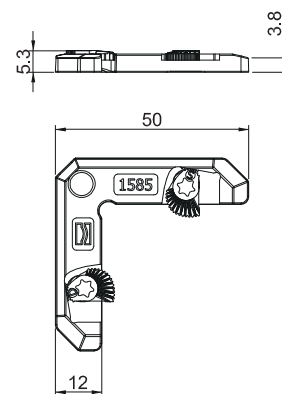

	5,3	12	250	2,75	€ 0,739
Categoria commerciale: 5G					

1586



-Squadretta di allineamento pressofusa con eccentrici

- Die-cast, aligning corner joint with grip eccentrics
- Équerre en aluminium pressé avec systèmes d'ancrage excentrique
- Druckgegusster Ausrichtungswinkel mit Exzenterscheibe

AKTIVA
PATENTED

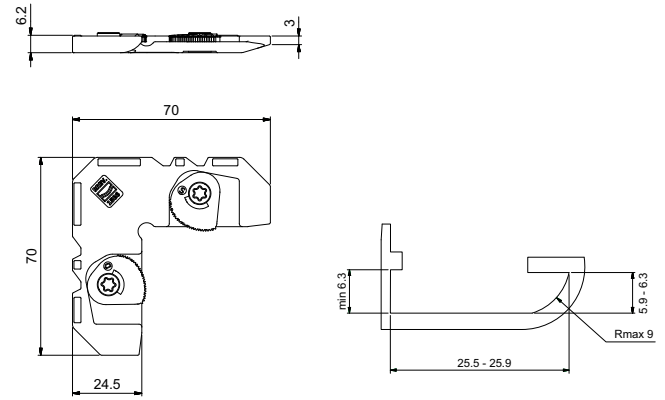

1586 AKTIVA	6,2	24,5	250	9,0	€ 0,783

Categoria commerciale: 5G

1587



-Squadretta di allineamento pressofusa con eccentrici

- Die-cast aligning corner-joint with grip eccentrics
- Équerre en aluminium pressé avec systèmes d'ancrage excentrique
- Druckgegusster Ausrichtungswinkel mit Exzenterscheibe

AKTIVA
PATENTED

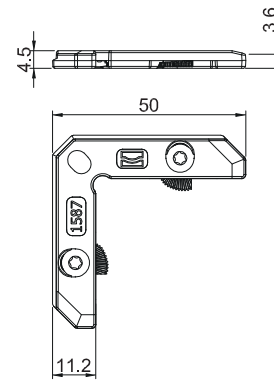

1587 AKTIVA	4,5	11,2	250	2,75	€ 0,739

Categoria commerciale: 5G

1588



-Squadretta di allineamento pressofusa con eccentrici

- Die-cast, aligning corner joint with grip eccentrics
- Équerre en aluminium pressé avec systèmes d'ancrage excentrique
- Druckgegusster Ausrichtungswinkel mit Exzenterscheibe

AKTIVA
PATENTED

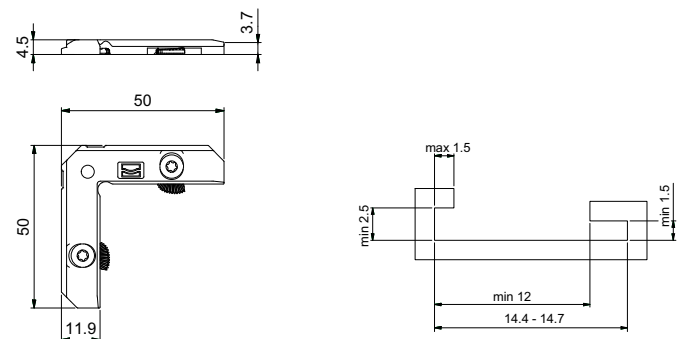

1588 AKTIVA	4,5	11,9	250	2,50	€ 0,783

Categoria commerciale: 5G

1589



-Squadretta di allineamento pressofusa con eccentrici

- Die-cast aligning corner-joint with grip eccentrics
- Équerre en aluminium pressé avec systèmes d'ancrage excentrique
- Druckgegusster Ausrichtungswinkel mitExzenterscheibe

AKTIVA
PATENTED

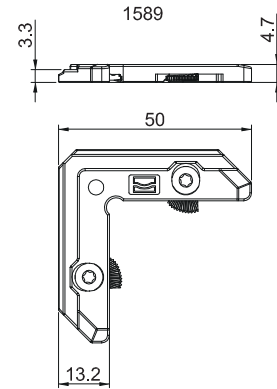

1589 AKTIVA	4,7	13,2	250	2,75	€ 0,739

Categoria commerciale: 5G

1590



-Squadretta di allineamento pressofusa con eccentrici

- Die-cast aligning corner-joint with grip eccentrics
- Équerre en aluminium pressé avec systèmes d'ancrage excentrique
- Druckgegusster Ausrichtungswinkel mitExzenterscheibe

AKTIVA
PATENTED

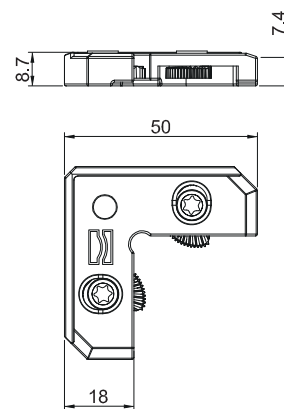

1590 AKTIVA	8,7	18	250	7,0	€ 1,101

Categoria commerciale: 5G

1592



-Squadretta di allineamento pressofusa con eccentrici

- Die-cast aligning corner-joint with grip eccentrics
- Équerre en aluminium pressé avec systèmes d'ancrage excentrique
- Druckgegusster Ausrichtungswinkel mitExzenterscheibe

AKTIVA
PATENTED

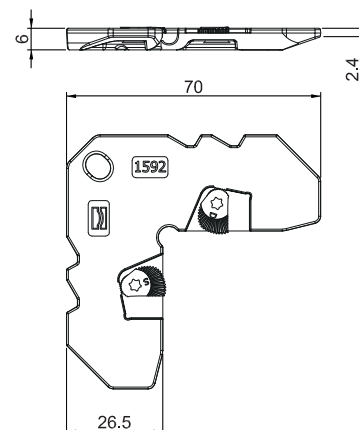

1592 AKTIVA	6	26,5	250	7,5	€ 1,254

Categoria commerciale: 5G

1593



-Squadretta di allineamento pressofusa con eccentrici

- Die-cast aligning corner-joint with grip eccentrics
- Équerre en aluminium pressé avec systèmes d'ancrage excentrique
- Druckgegusster Ausrichtungswinkel mit Exzenterscheibe

AKTIVA
PATENTED

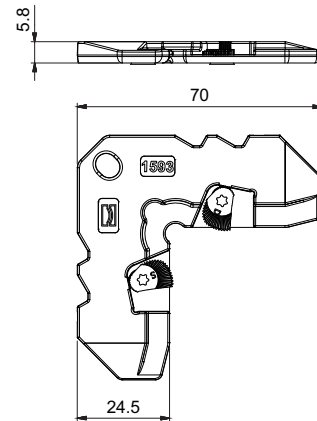

	L	H	W	T	P
1593 AKTIVA	5,8	24,5	250	7,0	€ 0,706

Categoria commerciale: 5G

1594



-Squadretta di allineamento pressofusa con eccentrici

- Die-cast aligning corner-joint with grip eccentrics
- Équerre en aluminium pressé avec systèmes d'ancrage excentrique
- Druckgegusster Ausrichtungswinkel mit Exzenterscheibe

AKTIVA
PATENTED

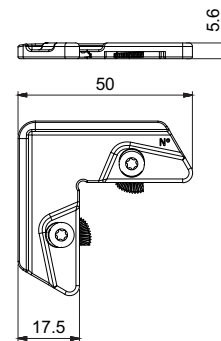

	L	H	W	T	P
1594 AKTIVA	5,6	17,5	250	4,0	€ 0,662

Categoria commerciale: 5G

1595



-Squadretta di allineamento pressofusa con eccentrici

- Die-cast aligning corner-joint with grip eccentrics
- Équerre en aluminium pressé avec systèmes d'ancrage excentrique
- Druckgegusster Ausrichtungswinkel mit Exzenterscheibe

AKTIVA
PATENTED

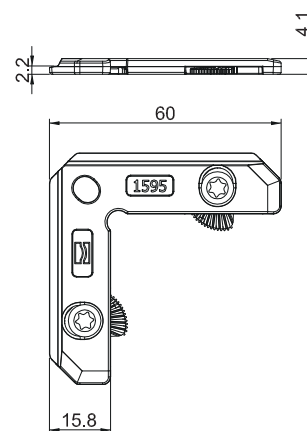

	L	H	W	T	P
1595 AKTIVA	4,1	15,8	250	3,0	€ 0,567

Categoria commerciale: 5G

1596



-Squadretta di allineamento pressofusa con eccentrici

- Die-cast aligning corner-joint with grip eccentrics
- Équerre en aluminium pressé avec systèmes d'ancrage excentrique
- Druckgegusste Ausrichtungswinkel mit Exzenterscheibe

AKTIVA
PATENTED

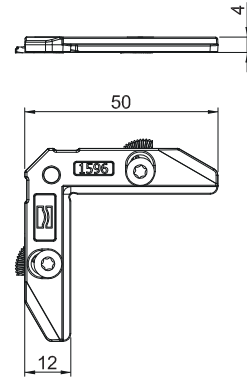

1596 AKTIVA	4	12	250	2,5	€ 0,711
Categoria commerciale: 5G					

1597



-Squadretta di allineamento pressofusa con eccentrici

- Die-cast aligning corner-joint with grip eccentrics
- Équerre en aluminium pressé avec systèmes d'ancrage excentrique
- Druckgegusste Ausrichtungswinkel mit Exzenterscheibe

AKTIVA
PATENTED

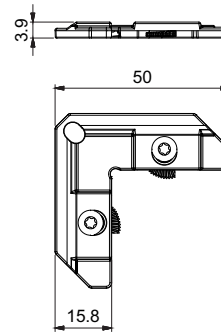

1597 AKTIVA	3,9	15,8	250	3,0	€ 0,662
Categoria commerciale: 5G					

1598



-Squadretta di allineamento pressofusa con eccentrici

- Die-cast aligning corner-joint with grip eccentrics
- Équerre en aluminium pressé avec systèmes d'ancrage excentrique
- Druckgegusste Ausrichtungswinkel mit Exzenterscheibe

AKTIVA
PATENTED

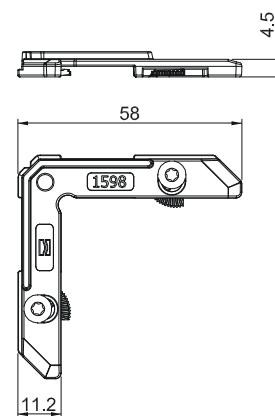

1598 AKTIVA	4,5	11,2	250	2,5	€ 0,711
Categoria commerciale: 5G					

1711

-Vite per squadrette
-Screw for corner-joints
-Vis pour équerres
-Schraube für Eckverbinder



Icon	L	Ø	Icon	Icon	€
1711	13,9	4,8	400	1,2	€ 0,166

Categoria commerciale: 5G

1712

-Vite per squadrette
-Screw for corner-joints
-Vis pour équerres
-Schraube für Eckverbinder



Icon	L	Ø	Icon	Icon	€
1712	20,0	6,3	400	2,4	€ 0,166

Categoria commerciale: 5G

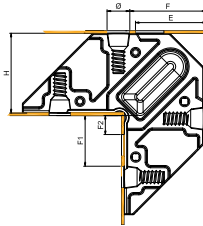

-Squadretta in alluminio ad espansione multifunzione

-Multifunctional expanding aluminium corner-joints
-équerres en aluminium à expansion multifonctionnel
-Ausdehnung-Eckverbinder aus Aluminium, multifunktion

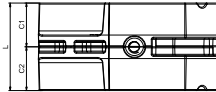

Icon	L	H	Icon	Icon	€
1807	41,8	31,7	50	8,70	€ 1,584
1808	41,2	21	50	8,70	€ 1,406
1809	46	26,8	50	8,70	€ 1,507
1811	26,8	31,4	50	8,70	€ 1,212
1812	41	37,4	50	7,20	€ 1,703
1813	40,4	40,9	50	7,20	€ 1,940
1814	26,4	14,8	50	7,20	€ 0,908
1815	28,5	14,5	150	21,60	€ 0,924
1816	13,4	11,7	150	21,60	€ 0,729
1817	39,8	12,6	50	7,20	€ 1,032
1818	46,2	12,6	50	7,20	€ 1,191
1819	55,2	12,6	50	7,20	€ 1,389
1820	38,1	56,8	50	7,20	€ 2,607
1821	39,8	42,8	50	7,20	€ 2,062
1822	55,2	32,6	50	7,20	€ 2,183
1823	55,2	22,4	50	7,20	€ 1,748
1824	45,8	56,8	50	7,20	€ 3,032
1825	38,7	42,8	50	7,20	€ 1,940
1826	46,2	32,6	50	7,20	€ 1,820
1827	42,4	22,4	50	7,20	€ 1,571
1828	39,8	56,8	50	7,20	€ 2,668
1829	19,8	14,9	50	7,20	€ 0,822
1830	24,4	14,5	200	28,80	€ 0,868
1831	24,4	26,4	150	21,60	€ 1,290
1832	23	14,4	200	28,80	€ 0,845
1833	29,1	14,6	150	21,60	€ 1,326
1834	16,8	14,3	200	28,80	€ 0,792
1835	17	35,8	100	14,40	€ 1,191
1836	23,1	35,8	100	14,40	€ 1,357
1837	26,4	35,8	100	14,40	€ 1,555
1838	33,8	35,8	50	7,20	€ 1,507
1839	19,5	14,5	200	28,80	€ 0,827

Categoria commerciale: 5G

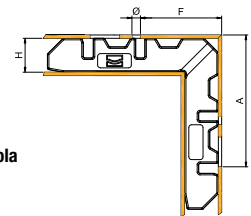

-Squadretta in alluminio a spinare e cianfrinare singola

-Single aluminium pinning and crimping corner-joint
-équerres en aluminium à goupiller et à sertir simples
-Einfach-Eckverbinder aus Aluminium mit Stift und Verklammerung



Icon	L	H	Icon	Icon	€
1620	4,9	11,9	250	3,00	€ 0,525
1621	6,9	6,2	250	2,50	€ 0,525
1622	4,3	14,0	250	3,00	€ 0,525
1623	11,9	11,9	250	6,75	€ 0,709
1624	11,9	8,4	250	6,75	€ 0,816
1625	7,5	10,1	250	6,75	€ 0,662
1626	4,3	10,1	250	6,75	€ 0,524
1627	2,6	9,0	250	6,75	€ 0,364
1628	8,9	12,1	250	6,75	€ 0,838
1629	4,3	14,0	250	6,75	€ 0,634
1630	5,1	17,4	250	6,75	€ 0,794
1631	9,0	12,0	250	6,75	€ 0,750
1632	9,7	28,7	200	5,40	€ 0,790
1633	8,8	13,6	250	6,75	€ 0,759
1634	6,2	15,2	250	6,75	€ 0,617
1635	4,3	26,1	250	6,75	€ 0,800
1636	4,3	39,1	250	6,75	€ 0,926
1637	6,2	7,2	250	6,75	€ 0,397
1638	5,3	10,7	250	6,75	€ 0,609
1639	5,3	14,7	250	6,75	€ 0,706
1640	5,3	24,7	200	5,00	€ 0,643
1641	8,9	7,9	250	6,25	€ 0,634
1642	5,0	7,0	250	6,25	€ 0,424
1643	2,9	13,6	250	6,25	€ 0,516
1644	7,5	14,8	250	6,25	€ 0,926
1645	7,5	10,1	250	5,00	€ 0,706
1646	15,4	32,6	250	6,25	€ 2,054
1647	15,4	15,0	250	6,25	€ 1,164
1648	6,9	6,2	250	6,25	€ 0,551
1649	10,6	19,5	250	6,25	€ 0,794

Categoria commerciale: 5G

1703

-Spina per squadrette

- Pin for corner-joints
- Goupille pour équerres
- Stift für Eckverbinder



Icona	L	Ø	Q	A	€
1703	9,5	3	400	1,60	€ 0,214

Categoria commerciale: 5G

1704

-Spina per squadrette

- Pin for corner-joints
- Goupille pour équerres
- Stift für Eckverbinder



Icona	L	Ø	Q	A	€
1704	13,0	8	400	1,00	€ 0,210

Categoria commerciale: 5G

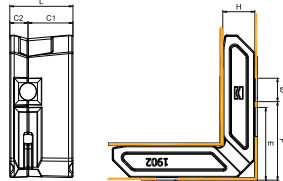

-Squadretta in alluminio a spinare e cianfrinare doppia

- Double aluminium pinning and crimping corner-joint
- équerres en aluminium à goupiller et à sertir double
- Doppel-Eckverbinder aus Aluminium mit Stift und Verklammerung

Icona	L	H	Q	A	€
1902	28,8	14,6	200	16,00	€ 1,152
1903	24,5	14,0	200	16,00	€ 1,095
1904	23,8	27,5	100	8,00	€ 1,520
1905	24,5	14,0	100	8,00	€ 1,224
1906	24,3	32,0	100	8,00	€ 1,557
1907	41	32,0	50	4,00	€ 2,401
1908	29,2	39,0	50	4,00	€ 1,910
1909	25,2	17,2	50	4,00	€ 1,210
1910	47,6	38,8	50	4,00	€ 2,892
1911	36,0	38,8	50	4,00	€ 2,566
1912	41,4	10,0	100	9,60	€ 1,259
1913	46,4	14,4	100	9,60	€ 1,513
1914	19,0	38,7	100	9,60	€ 1,629
1915	24,0	14,0	250	24,00	€ 1,088

Categoria commerciale: 5G

1705

-Spina per squadrette

- Pin for corner-joints
- Goupille pour équerres
- Stift für Eckverbinder

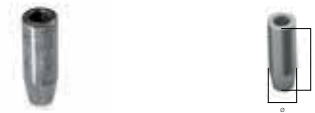

Icona	L	Ø	Q	A	€
1705	14,0	5	400	1,00	€ 0,210

Categoria commerciale: 5G

1550

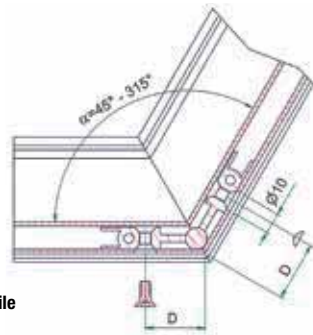

-Squadretta in alluminio estruso ad angolo variabile

- Aluminium extruded corner-joint with adjustable angle
- Equerre en alu extrudé - angle variable
- Eckverbinder aus Strangpressaluminium mit verstellbarem Winkel

Icona	L	H	D	Q	A	€
1550	41	10,5	25+(7xB÷A)	50	3,20	€ 4,205

Categoria commerciale: 5E

1551

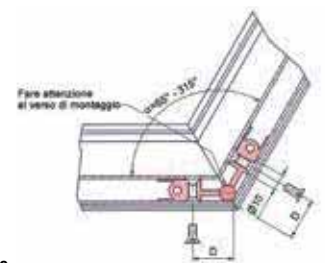

-Squadretta in alluminio estruso ad angolo variabile

- Aluminium extruded corner-joint with adjustable angle
- Equerre en alu extrudé - angle variable
- Eckverbinder aus Strangpressaluminium mit verstellbarem Winkel

Icona	L	H	D	Q	A	€
1551	28,4	14	25+(7xB÷A)	50	2,70	€ 3,922

Categoria commerciale: 5E

1552

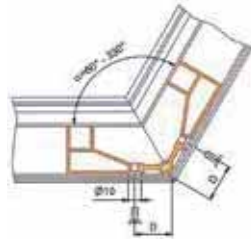

- Squadretta in alluminio estruso ad angolo variabile
- Aluminium extruded corner-joint with adjustable angle
- Equerre en alu extrudé - angle variable
- Eckverbinder aus Strangpressaluminium mit verstellbarem Winkel

Icona	L	H	D	Icona	Icona	€
1552	33,5	35,8	25+(7xB÷A)	20	1,80	€ 10,257

Categoria commerciale: 5E

1553

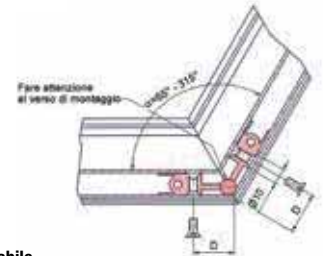

- Squadretta in alluminio estruso ad angolo variabile
- Aluminium extruded corner-joint with adjustable angle
- Equerre en alu extrudé - angle variable
- Eckverbinder aus Strangpressaluminium mit verstellbarem Winkel

Icona	L	H	D	Icona	Icona	€
1553	36	14	25+(7xB÷A)	50	3,50	€ 5,525

Categoria commerciale: 5E

1554

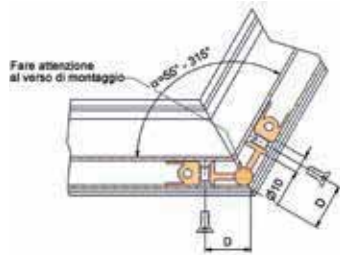

- Squadretta in alluminio estruso ad angolo variabile
- Aluminium extruded corner-joint with adjustable angle
- Equerre en alu extrudé - angle variable
- Eckverbinder aus Strangpressaluminium mit verstellbarem Winkel

Icona	L	H	D	Icona	Icona	€
1554	23,2	14	25+(7xB÷A)	50	2,00	€ 4,001

Categoria commerciale: 5E

1555

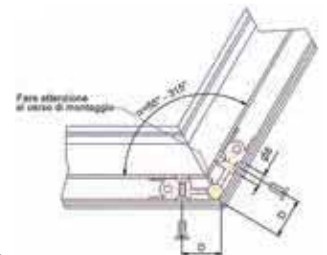

- Squadretta in alluminio estruso ad angolo variabile
- Aluminium extruded corner-joint with adjustable angle
- Equerre en alu extrudé - angle variable
- Eckverbinder aus Strangpressaluminium mit verstellbarem Winkel

Icona	L	H	D	Icona	Icona	€
1555	24	14	25+(7xB÷A)	50	2,40	€ 4,113

Categoria commerciale: 5E

1556

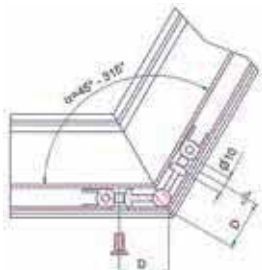

- Squadretta in alluminio estruso ad angolo variabile
- Aluminium extruded corner-joint with adjustable angle
- Equerre en alu extrudé - angle variable
- Eckverbinder aus Strangpressaluminium mit verstellbarem Winkel

Icona	L	H	D	Icona	Icona	€
1556	36	10,4	25+(7xB÷A)	50	7,3	€ 4,702

Categoria commerciale: 5E

1557



- Squadretta in alluminio estruso ad angolo variabile
- Aluminium extruded corner-joint with adjustable angle
- Equerre en alu extrudé - angle variable
- Eckverbinder aus Strangpressaluminium mit verstellbarem Winkel

Icona	L	H	D	Icona	Icona	€
1557	28,4	34,5	25+(7xB÷A)	20	1,50	€ 9,232

Categoria commerciale: 5E

1558

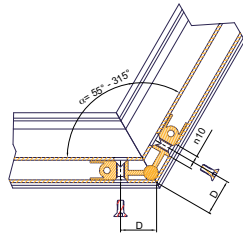

- Squadretta in alluminio estruso ad angolo variabile
- Aluminium extruded corner-joint with adjustable angle
- Equerre en alu extrudé - angle variable
- Eckverbinder aus Strangpressaluminium mit verstellbarem Winkel

1558	28,4	14	25+(7xB÷A)	50	2,95	€ 4,408

Categoria commerciale: 5E

1559

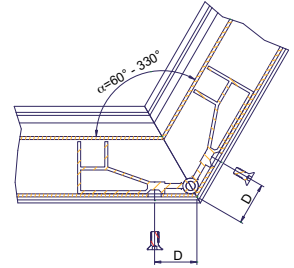

- Squadretta in alluminio estruso ad angolo variabile
- Aluminium extruded corner-joint with adjustable angle
- Equerre en alu extrudé - angle variable
- Eckverbinder aus Strangpressaluminium mit verstellbarem Winkel

1559	22,8	35,5	25+(7xB÷A)	20	1,34	€ 8,042

Categoria commerciale: 5E

1560

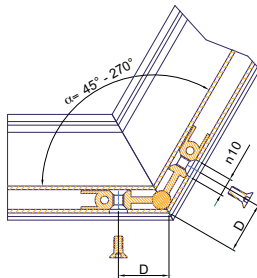

- Squadretta in alluminio estruso ad angolo variabile
- Aluminium extruded corner-joint with adjustable angle
- Equerre en alu extrudé - angle variable
- Eckverbinder aus Strangpressaluminium mit verstellbarem Winkel

1560	32	10,4	25+(7xB÷A)	50	3,10	€ 3,378

Categoria commerciale: 5E

1561

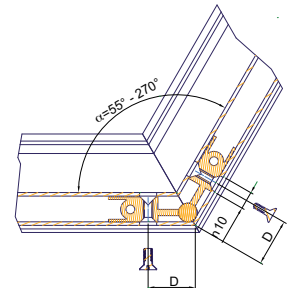

- Squadretta in alluminio estruso ad angolo variabile
- Aluminium extruded corner-joint with adjustable angle
- Equerre en alu extrudé - angle variable
- Eckverbinder aus Strangpressaluminium mit verstellbarem Winkel

1561	32,8	14	25+(7xB÷A)	50	2,90	€ 4,298

Categoria commerciale: 5E

1562

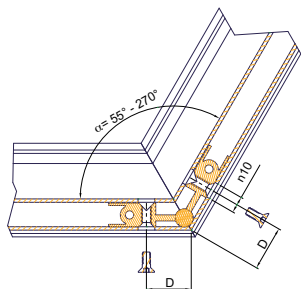

- Squadretta in alluminio estruso ad angolo variabile
- Aluminium extruded corner-joint with adjustable angle
- Equerre en alu extrudé - angle variable
- Eckverbinder aus Strangpressaluminium mit verstellbarem Winkel

1562	45,5	14	25+(7xB÷A)	50	3,20	€ 4,433

Categoria commerciale: 5E

1563

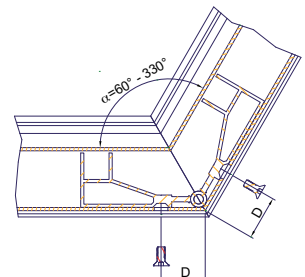

- Squadretta in alluminio estruso ad angolo variabile
- Aluminium extruded corner-joint with adjustable angle
- Equerre en alu extrudé - angle variable
- Eckverbinder aus Strangpressaluminium mit verstellbarem Winkel

1563	40	26	25+(7xB÷A)	20	1,74	€ 9,648

Categoria commerciale: 5E

1564

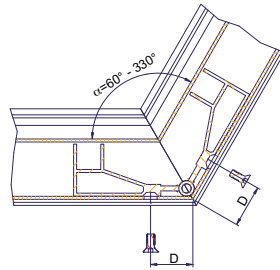

-Squadretta in alluminio estruso ad angolo variabile

-Aluminium extruded corner-joint with adjustable angle

-Equerre en alu extrudé - angle variable

-Eckverbinder aus Strangpressaluminium mit verstellbarem Winkel

Code	L	H	D	Sp	A	€
1564	27	31,5	25+(7xB÷A)	20	1,58	€ 8,915

Categoria commerciale: 5E

1565

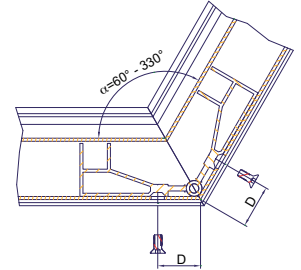

-Squadretta in alluminio estruso ad angolo variabile

-Aluminium extruded corner-joint with adjustable angle

-Equerre en alu extrudé - angle variable

-Eckverbinder aus Strangpressaluminium mit verstellbarem Winkel

Code	L	H	D	Sp	A	€
1565	20,4	34,8	25+(7xB÷A)	20	1,22	€ 8,915

Categoria commerciale: 5E

1566

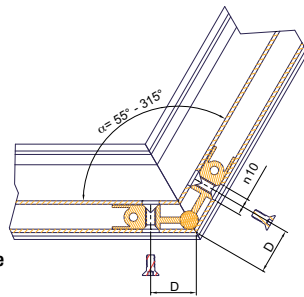

-Squadretta in alluminio estruso ad angolo variabile

-Aluminium extruded corner-joint with adjustable angle

-Equerre en alu extrudé - angle variable

-Eckverbinder aus Strangpressaluminium mit verstellbarem Winkel

Code	L	H	D	Sp	A	€
1566	21,5	10,5	25+(7xB÷A)	50	2,00	€ 4,182

Categoria commerciale: 5E

1567

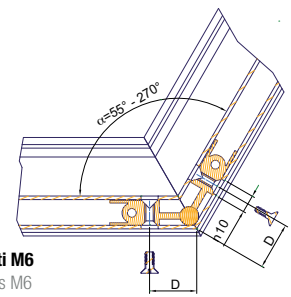

-Squadretta in alluminio ad angolo variabile con viti M6

-Aluminium corner-joint with adjustable angle with screws M6

-Équerre aluminium - angle variable avec des vis M6

-Eckverbinder aus Aluminium mit verstellbarem Winkel mit Schrauben

Code	L	H	D	Sp	A	€
1567	21,8	14	25+(7xB÷A)	50	2,00	€ 3,999

Categoria commerciale: 5E

1568

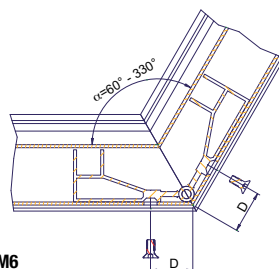

-Squadretta in alluminio ad angolo variabile con viti M6

-Aluminium corner-joint with adjustable angle with screws M6

-Équerre aluminium - angle variable avec des vis M6

-Eckverbinder aus Aluminium mit verstellbarem Winkel mit Schrauben

Code	L	H	D	Sp	A	€
1568	21,8	35,8	25+(7xB÷A)	20	1,30	€ 8,882

Categoria commerciale: 5E

1500-R40

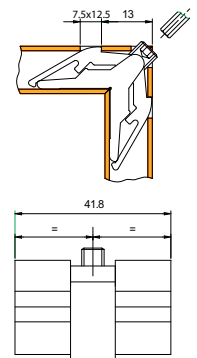

-Squadretta in alluminio estruso

-Extruded aluminium corner-joint

-Equerre en aluminium extrudé

-Eckverbinder aus Strangpressaluminium

Code	L	H	F	Sp	A	€
1500-R40	41,8	10	13	200	6,20	€ 1,331

Categoria commerciale: 5E

1501-R50

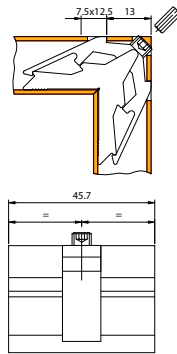

-Squadretta in alluminio estruso
 -Extruded aluminium corner-joint
 -Equerre en aluminium extrudé
 -Eckverbinder aus Strangpressaluminium

1501-R50	45,7	14,4	13	100	4,30

Categoria commerciale: 5E

1502-R50 T.T.

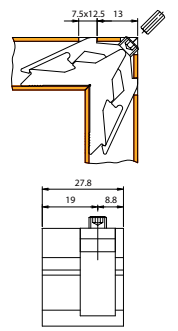

-Squadretta in alluminio estruso
 -Extruded aluminium corner-joint
 -Equerre en aluminium extrudé
 -Eckverbinder aus Strangpressaluminium

1502-R50 T.T.	27,8	14	13	200	6,00

Categoria commerciale: 5E

1503-R50 T.T.

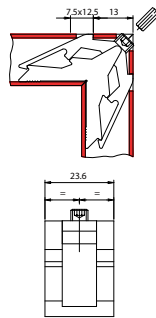

-Squadretta in alluminio estruso
 -Extruded aluminium corner-joint
 -Equerre en aluminium extrudé
 -Eckverbinder aus Strangpressaluminium

1503-R50 T.T.	23,6	14,2	13	100	2,80

Categoria commerciale: 5E

1201-R40

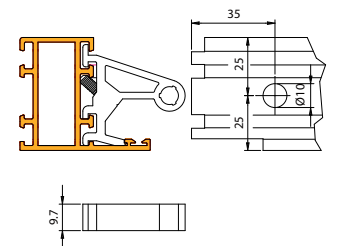

-Cavalotto in alluminio estruso
 -Aluminium fixing-joint
 -Jonction en aluminium
 -T-Verbinder aus Strangpressaluminium

1201-R40	9,7	200	3,20

Categoria commerciale: 5E

1202-R50 T.T.

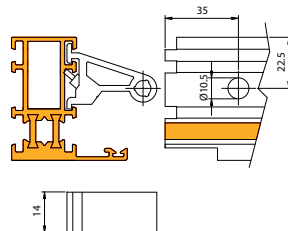

-Cavalotto in alluminio estruso
 -Aluminium fixing-joint
 -Jonction en aluminium
 -T-Verbinder aus Strangpressaluminium

1202-R50 TT	14	200	3,40

Categoria commerciale: 5E

1204

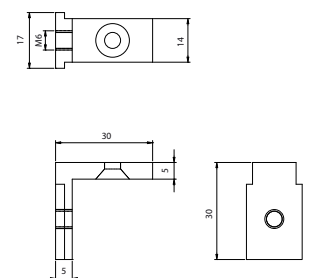

-Cavalotto in alluminio
 -Aluminium fixing-joint
 -Jonction en aluminium
 -T-Verbinder aus Aluminium

1204	17	5	100	1,10

Categoria commerciale: 5E

1215

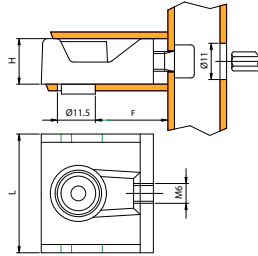

-Cavallotto in alluminio pressofuso
-Aluminium fixing-joint
-Jonction en aluminium
-T-Verbinder aus Aluminium

	L	H	F	Ø	MG	€
1215-40X18	35,9	13,8	22	250	5,50	€ 0,552
1215-40X20 GR9	36	14,9	22	250	6,25	€ 0,572
1215-45X20	40	15,9	25	250	11,75	€ 0,945
1215-50X20	45	15,9	25	250	13,00	€ 0,994
1215-50X25	45	20,8	30	250	12,75	€ 1,164

Categoria commerciale: 5G

1220

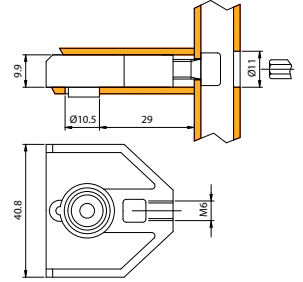

-Cavallotto in alluminio pressofuso
-Aluminium fixing-joint
-Jonction en aluminium
-T-Verbinder aus Aluminium

	L	H	Ø	MG	€
1220	40,8	9,9	250	5,50	€ 0,552
1220 - 7,5	40,8	9,9	250	5,75	€ 0,608

Categoria commerciale: 5G

1221

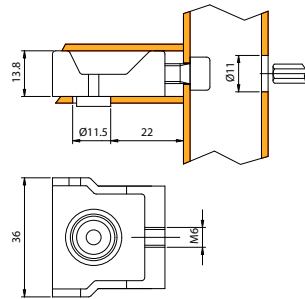

-Cavallotto in alluminio pressofuso
-Aluminium fixing-joint
-Jonction en aluminium
-T-Verbinder aus Aluminium

	L	H	Ø	MG	€
1221	36	13,8	250	5,75	€ 0,552

Categoria commerciale: 5G

1225

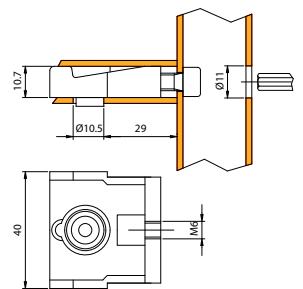

-Cavallotto in alluminio pressofuso
-Aluminium fixing-joint
-Jonction en aluminium
-T-Verbinder aus Aluminium

	L	H	Ø	MG	€
1225	40	10,7	250	5,75	€ 0,675

Categoria commerciale: 5G

1227

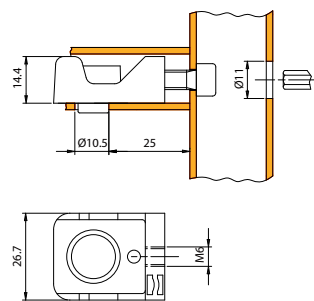

-Cavallotto in alluminio pressofuso
-Aluminium fixing-joint
-Jonction en aluminium
-T-Verbinder aus Aluminium

	L	H	Ø	MG	€
1227	26,7	14,4	250	5,00	€ 0,585

Categoria commerciale: 5G

1231-36

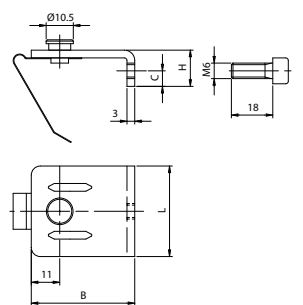

-Giunzione a molla in acciaio zincato
-Galvanized fixing-joint with spring
-Jonction à ressort en acier zingué
-T-Verbinder aus Stahl, verzinkt

	L	H	Ø	MG	€	
1231-36	zinc	35	14	100	5,20	€ 0,862

Categoria commerciale: 5C

1232

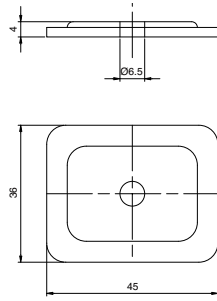

- Placchetta in acciaio zincato
- Plate for fixing joints
- Platine pour jonction
- Plättchen für T-Verbinder aus Stahl, verzinkt

1232 PLACCHETTA	zinc	45	4	200	6,00	€ 0,291

Categoria commerciale: 5C

1233

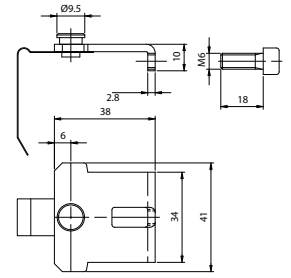

- Giunzione a molla in acciaio zincato
- Galvanized fixing-joint with spring
- Jonction à ressort en acier zingué
- T-Verbinder aus Stahl, verzinkt

1233	zinc	41	10	100	4,30	€ 0,794

Categoria commerciale: 5C

1235

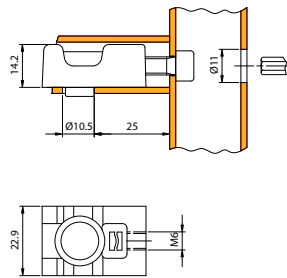

- Cavallotto in alluminio pressofuso
- Aluminium fixing-joint
- Jonction en aluminium
- T-Verbinder aus Aluminium

1235	zinc	22,9	14,2	25	250	5,50	€ 0,585

Categoria commerciale: 5G

1264

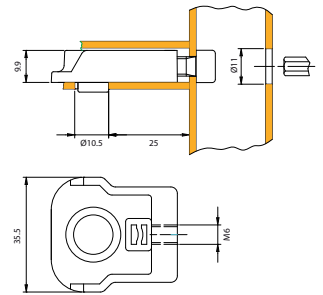

- Cavallotto in alluminio pressofuso
- Aluminium fixing-joint
- Jonction en aluminium
- T-Verbinder aus Aluminium

1264	zinc	35,5	9,9	25	250	5,50	€ 0,552

Categoria commerciale: 5A

1245

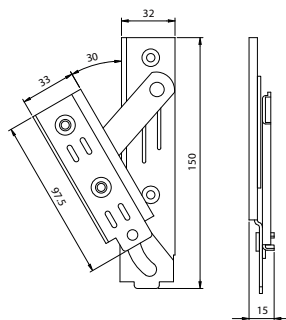

- Coppia cerniera per Vasistas
- Pair of hinges for transom windows
- Couple de charnières pour fenêtre à vasistas
- Scharniere für Klappfenster

1245	zinc	32	15	10	3,07	€ 4,234

Categoria commerciale: 5A

1255

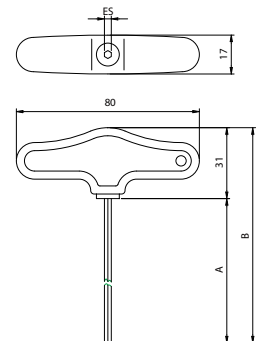

- Chiave esagonale per squadrette
- Hexagonal key
- Clé hexagonale pour equerre
- Sechseckiger Schlüssel für Eckverbinder

1255-MM.3	zinc	3	95	126	50	1,70	€ 5,405
1255-MM.4	zinc	4	148	179	50	2,10	€ 5,521
1255-MM.5	zinc	5	148	179	50	2,90	€ 5,875

Categoria commerciale: 5H

1270i INOX

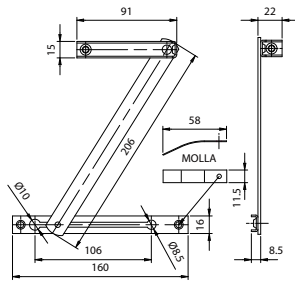

- Ferma finestra in acciaio
- Steel window-stop
- Entrebaillieur en acier
- Fensterklammer aus Stahl

1270i	inox	50	7,00	€ 4,234

Categoria commerciale: 5A

1275

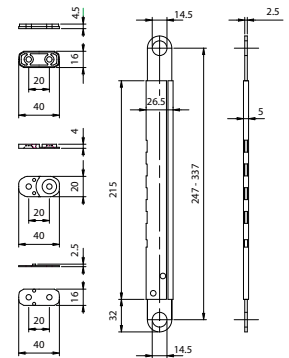

- Coppia bracci telescopici per sporgere
- Pair of arms for protruding windows
- Couple de bras pour fenêtre en saillie
- Teleskop-Ausleger

1275	zinc	20	8,90	€ 11,483

Categoria commerciale: 5A

1275i INOX

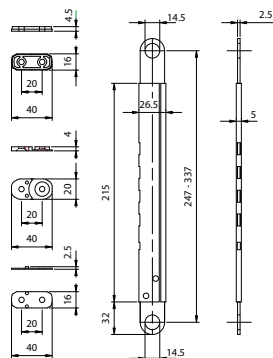

- Coppia bracci telescopici per sporgere
- Pair of arms for protruding windows
- Couple de bras pour fenêtre en saillie
- Teleskop-Ausleger

1275i	inox	20	8,90	€ 20,901

Categoria commerciale: 5A

1276i

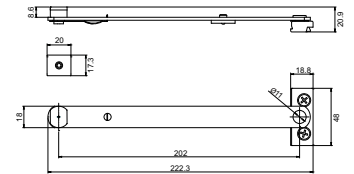

- Coppia bracci limitatori per Vasistas universali
- Pairs of arms for all-purpose transom window
- Couple de bras pour vasistas universels
- Ausleger für Klappfenster

1276i	inox	20	8,90	€ 10,452

Categoria commerciale: 5A

1457

-Kit base scorrevoli EXPORT 60/S con maniglie e squadrette

- Basic kit for sliding windows EXPORT 60/S with handles and corner-joint
- Kit base pour fenêtres coulissantes EXPORT 60/S avec béquilles et équerres
- Basis-Satz für Schiebefenster EXPORT 60/S mit Griffen und Eckverbindern

1457	1	1,2	18,375

Categoria commerciale: 5B



1461

-Kit base scorrevoli NC 60 INT.con maniglie e squadrette

- Basic kit for sliding windows EXPORT 60/S with handles and corner-joint
- Kit base pour fenêtres coulissantes EXPORT 60/S avec béquilles et équerres
- Basis-Satz für Schiebefenster EXPORT 60/S mit Griffen und Eckverbindern

1461	1	1,31	13,764

Categoria commerciale: 5B



1468-A

-Kit base di accessori adatto per una finestra scorrevole a 2 ante.

- Basic kit for sliding windows 2 leaves
- Kit base pour fenêtres coulissantes avec 2 vantaux
- Basis-Satz für Schiebefenster mit 2 Türen

1468-A	1	1,28	44,548

Categoria commerciale: 5B



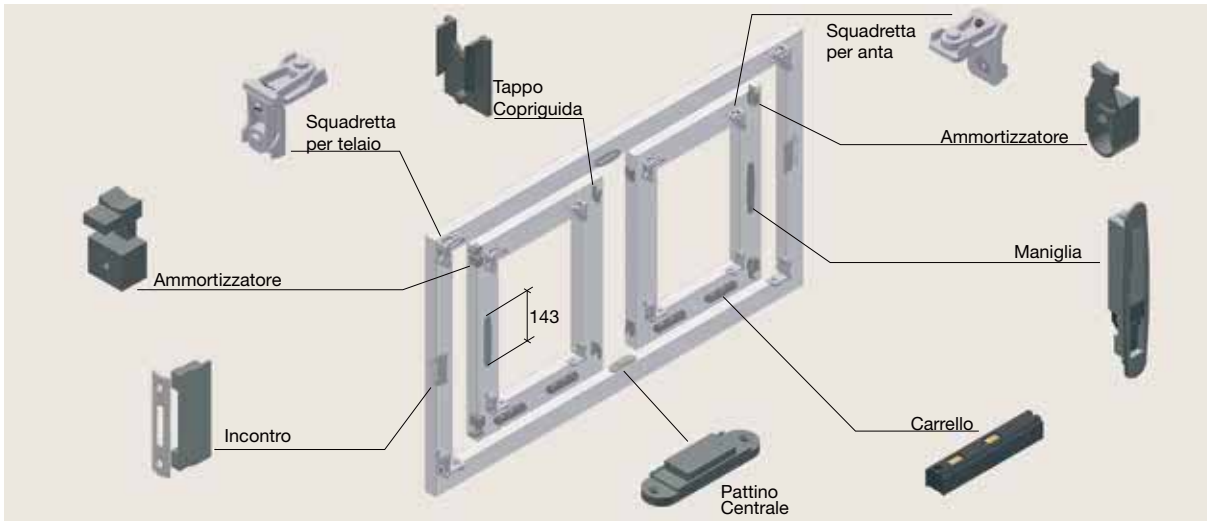
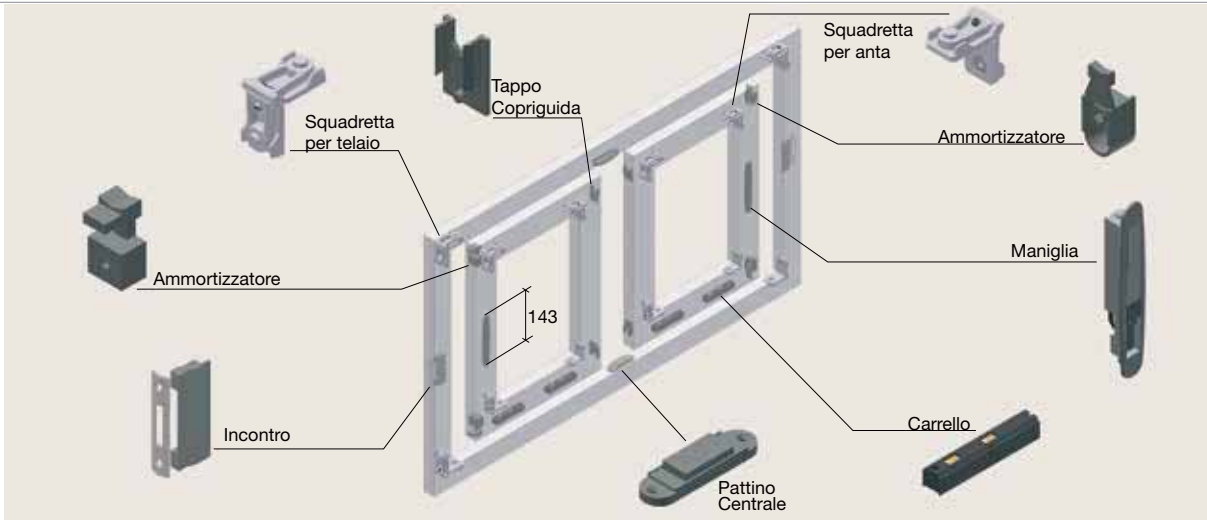











Life made easy

COMUNELLO

FRAME DIVISION

LEGENDA

	Articolo / Article
	Diametro maniglione / Pull handle diameter
	Misura maniglione quadrato / Square handle size
	Materiale / Material
	Materiale maniglione / Pull handle material
	Finitura / Finishing
	Pezzi per confezione / Pieces per pack
	Peso confezione / Weight of pack
	Prezzo / Price
	Codici 24 ore / 24 hour codes

Finitura acciaio Inox

Finishing stainless steel

009	Lucida / Polished - 24H
010	Satinata / Satin - 24H
015	PVD oro lucido / Polished gold PVD - 24H
105	PVD oro satinato / Satin gold <i>Su richiesta / On request</i>
110	PVD nickel lucido / Polished nickel PVD <i>Su richiesta / On request</i>
115	PVD nickel satinato / Satin nickel PVD <i>Su richiesta / On request</i>
120	PVD bronzo lucido / Polished bronze <i>Su richiesta / On request</i>
125	PVD bronzo satinato / Satin bronze <i>Su richiesta / On request</i>
130	PVD antracite lucido / Polished anthracite metal PVD <i>Su richiesta / On request</i>
135	PVD antracite satinato / Satin anthracite metal PVD <i>Su richiesta / On request</i>



Pull handles



Finitura alluminio

Finishing aluminium

604	Anodizzato satinato argento / Anodized satined silver - 24H
503	Nero RAL / Black - 24H
607	Anodizzato argento brillantato / Anodized silver <i>Su richiesta / On request</i>
602	Anodizzato oro / Anodized gold <i>Su richiesta / On request</i>
603	Anodizzato bronzo / Anodized bronze <i>Su richiesta / On request</i>
9010	Bianco RAL / White <i>Su richiesta / On request</i>
3003	Rosso RAL / Red <i>Su richiesta / On request</i>
3007	Rosso RAL / Red <i>Su richiesta / On request</i>
8022	Marrone RAL / Brown <i>Su richiesta / On request</i>
5002	Azzurro RAL / Blue <i>Su richiesta / On request</i>
7035	Grigio RAL / Gray <i>Su richiesta / On request</i>
7016	Grigio antracite RAL / Anthracite gray <i>Su richiesta / On request</i>
6029	Verde RAL / Green <i>Su richiesta / On request</i>
5011	Giallo RAL / Yellow <i>Su richiesta / On request</i>

Finitura nylon

Finishing nylon

9010	Bianco RAL / White - 24H
9005	Nero RAL / Black - 24H



Ambidestro
ambidextrous
ambidextre
beidhändig

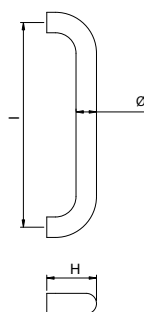

-Fissaggi vedi pag. 216
-Fixings - page 216
-Fixations voir - page 216
-Befestigung siehe - seite 216

2000 AL

ARTICOLO			Ø	I	H	€		
2-0722-604	Alluminio	Argento satinato	20	60	200	€ 33,824	2	0,36
2-0744-604	Alluminio	Argento satinato	25	70	300	€ 37,676	2	0,68
2-0762-604	Alluminio	Argento satinato	30	85	230	€ 42,960	2	0,72
2-0764-604	Alluminio	Argento satinato	30	85	300	€ 45,140	2	0,85
2-0765-9005	Alluminio	Nero	30	85	320	€ 30,093	2	0,89
2-0766-604	Alluminio	Argento satinato	30	85	350	€ 47,186	2	0,95
2-0782-9005	Alluminio	Nero	35	85	350	€ 33,584	2	1,19
2-0786-604	Alluminio	Argento satinato	35	85	650	€ 60,427	2	1,92
2-0786-9005	Alluminio	Nero	35	85	650	€ 39,241	2	1,92

Categoria commerciale: 4E

SPECIALI			Ø	I	H	€
SP-2000-Ø-I	Alluminio	Verniciato	su richiesta	su richiesta	su richiesta	
SP-2000-Ø-I	Alluminio	Anodizzato	su richiesta	su richiesta	su richiesta	



Ambidestro
ambidextrous
ambidextre
beidhändig

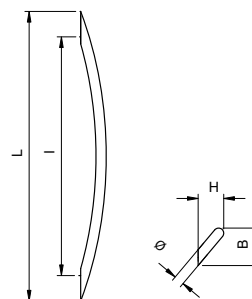

-Fissaggi vedi pag. 216
-Fixings - page 216
-Fixations voir - page 216
-Befestigung siehe - seite 216

2100 AL

ARTICOLO			Ø	I	H	B	€		
2-1763-604	Alluminio	Argento satinato	30	350	75	110	€ 82,455	2	1,21
2-1767-604	Alluminio	Argento satinato	30	700	75	110	€ 107,130	2	1,88

Categoria commerciale: 4E



Ambidestro
ambidextrous
ambidextre
beidhändig

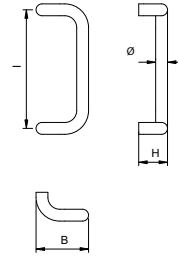

-Fissaggi vedi pag. 216
-Fixings - page 216
-Fixations voir - page 216
-Befestigung siehe - seite 216

2200 AL

ARTICOLO			Ø	I	H	B	€		
2-2762-9005	Alluminio	Nero	30	230	85	145	€ 33,824	2	0,94
2-2762-604	Alluminio	Argento satinato	30	230	85	145	€ 55,371	2	0,94
2-2764-604	Alluminio	Argento satinato	30	300	85	145	€ 61,148	2	1,07
2-2764-9005	Alluminio	Nero	30	300	85	145	€ 38,157	2	1,07
2-2766-604	Alluminio	Argento satinato	30	350	85	145	€ 62,232	2	1,17
2-2766-9005	Alluminio	Nero	30	350	85	145	€ 39,000	2	1,17
2-2782-604	Alluminio	Argento satinato	35	350	85	155	€ 67,889	2	1,50
2-2782-9005	Alluminio	Nero	35	350	85	155	€ 42,491	2	1,50

Categoria commerciale: 4E

SPECIALI			Ø	I	H	B	€		
SP-2200-Ø-I	Alluminio	Verniciato	su richiesta	su richiesta	su richiesta	su richiesta			
SP-2200-Ø-I	Alluminio	Anodizzato	su richiesta	su richiesta	su richiesta	su richiesta			

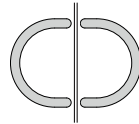

Ambidestro
ambidextrous
ambidextre
beidhändig

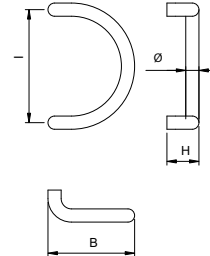

-Fissaggi vedi pag. 216
-Fixings - page 216
-Fixations voir - page 216
-Befestigung siehe - seite 216

2600 AL

ARTICOLO			Ø	I	H	B	€		
2-6765-604	Alluminio	Argento satinato	30	300	85	225	€ 57,297	2	1,16
2-6767-503	Alluminio	Nero	30	350	85	245	€ 36,352	2	1,28
2-6783-604	Alluminio	Argento satinato	35	300	85	230	€ 60,427	2	1,49
2-6783-9005	Alluminio	Nero	35	300	85	230	€ 38,157	2	1,49
2-6785-604	Alluminio	Argento satinato	35	350	85	260	€ 63,797	2	1,68
2-6785-9005	Alluminio	Nero	35	350	85	260	€ 39,842	2	1,68

Categoria commerciale: 4E

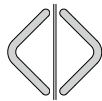

Ambidestro
ambidextrous
ambidextre
beidhändig

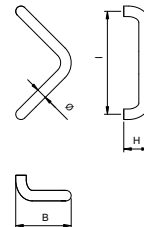

-Fissaggi vedi pag. 216
-Fixings - page 216
-Fixations voir - page 216
-Befestigung siehe - seite 216

2700 AL

ARTICOLO			Ø	I	H	B	€		
2-7763-604	Alluminio	Argento satinato	30	300	85	159	€ 45,260	2	0,97
2-7763-9005	Alluminio	Nero	30	300	85	159	€ 33,343	2	0,97
2-7765-604	Alluminio	Argento satinato	30	350	85	184	€ 46,222	2	1,10
2-7765-9005	Alluminio	Nero	30	350	85	184	€ 34,306	2	1,10
2-7788-604	Alluminio	Argento satinato	35	425	85	226	€ 52,121	2	1,62
2-7788-9005	Alluminio	Nero	35	425	85	188	€ 39,602	2	1,62

Categoria commerciale: 4E

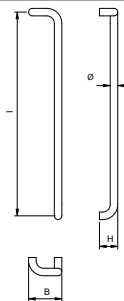
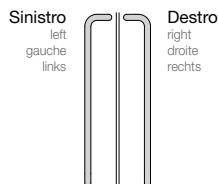

-Fissaggi vedi pag. 216
-Fixings - page 216
-Fixations voir - page 216
-Befestigung siehe - seite 216

2800 AL

ARTICOLO			Ø	I	H	B	€		
2-8786-604	Alluminio	Argento satinato	35	1200	85	155	€ 117,121	1DX	1,71
2-8786-604	Alluminio	Argento satinato	35	1200	85	155	€ 117,121	1SX	1,71
2-8786-9005	Alluminio	Nero	35	1200	85	155	€ 58,862	1DX	1,71
2-8786-9005	Alluminio	Nero	35	1200	85	155	€ 58,862	1SX	1,71

Categoria commerciale: 4E

SPECIALI			Ø	I	H	B	€		
SP-2800-Ø-I	Alluminio	Verniciato	su richiesta	su richiesta	su richiesta	su richiesta			
SP-2800-Ø-I	Alluminio	Anodizzato	su richiesta	su richiesta	su richiesta	su richiesta			

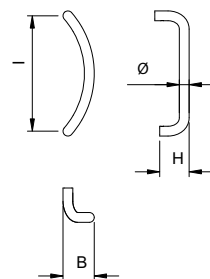
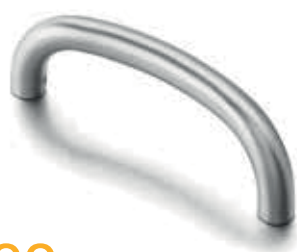

-Fissaggi vedi pag. 216
-Fixings - page 216
-Fixations voir - page 216
-Befestigung siehe - seite 216

2900 AL

ARTICOLO			Ø	I	H	B	€		
2-9765-604	Alluminio	Argento satinato	30	350	85	98	€ 45,380	2	0,99
2-9768-604	Alluminio	Argento satinato	30	500	85	98	€ 48,510	2	1,29
2-9788-604	Alluminio	Argento satinato	35	500	85	98	€ 50,436	2	1,62

Categoria commerciale: 4E

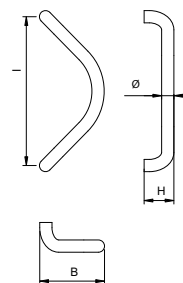

-Fissaggi vedi pag. 216
-Fixings - page 216
-Fixations voir - page 216
-Befestigung siehe - seite 216

2902 AL

ARTICOLO			Ø	I	H	B	€		
2-9862-604	Alluminio	Argento satinato	30	300	85	180	€ 48,148	2	1,05
2-9883-604	Alluminio	Argento satinato	35	350	85	185	€ 53,686	2	1,41
2-9883-9005	Alluminio	Nero	35	350	85	185	€ 42,371	2	1,41

Categoria commerciale: 4E



Ambidestro
ambidextrous
ambidextre
beidhändig

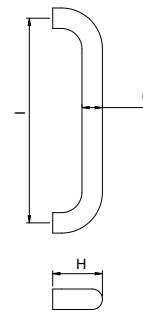

-Fissaggi vedi pag. 216
-Fixings - page 216
-Fixations voir - page 216
-Befestigung siehe - seite 216

2000 INOX 316L

ARTICOLO			Ø	H	I	€		
2-0122-010	Inox/st-steel	Satinato	20	60	200	€ 43,334	2	0,67
2-0125-010	Inox/st-steel	Satinato	20	60	350	€ 48,028	2	1,06
2-0144-009	Inox/st-steel	Lucido	25	70	300	€ 62,352	2	1,18
2-0164-009	Inox/st-steel	Lucido	30	85	300	€ 58,982	2	1,23
2-0164-010	Inox/st-steel	Satinato	30	85	300	€ 56,213	2	1,23
2-0166-010	Inox/st-steel	Satinato	30	85	350	€ 62,834	2	1,37
2-0182-010	Inox/st-steel	Satinato	35	85	350	€ 62,473	2	1,56
2-0182-015	Inox/st-steel	PVD	35	85	350	€ 157,445	2	1,56
2-0186-010	Inox/st-steel	Satinato	35	85	650	€ 85,825	2	2,55

Categoria commerciale: 4D

INOX 304			Ø	H	I	€		
2-244-010	Inox/st-steel	SATINATO	30	85	350	€ 22,533	2	0,69

SPECIALI			Ø	H	I	€
SP-2000-Ø-I	Inox	Lucido	su richiesta	su richiesta	su richiesta	
SP-2000-Ø-I	Inox	Satinato	su richiesta	su richiesta	su richiesta	
SP-2000-Ø-I	Inox	PVD	su richiesta	su richiesta	su richiesta	



Ambidestro
ambidextrous
ambidextre
beidhändig

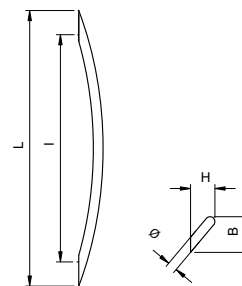

-Fissaggi vedi pag. 216
-Fixings - page 216
-Fixations voir - page 216
-Befestigung siehe - seite 216

2100 INOX 316L

ARTICOLO			Ø	I	L	H	B	€		
2-1147-010	Inox/st-steel	Satinato	25	700	849	75	106	€ 123,260	2	2,90
2-1163-010	Inox/st-steel	Satinato	30	350	412	75	110	€ 98,584	2	2,27
2-1163-015	Inox/st-steel	PVD	30	350	412	75	110	€ 262,650	2	2,27
2-1165-010	Inox/st-steel	Satinato	30	500	602	75	110	€ 108,695	2	2,62
2-1165-015	Inox/st-steel	PVD	30	500	602	75	110	€ 272,761	2	2,62
2-1167-009	Inox/st-steel	Lucido	30	700	849	75	110	€ 126,028	2	3,48
2-1167-010	Inox/st-steel	Satinato	30	700	849	75	110	€ 123,260	2	3,48

Categoria commerciale: 4D

INOX 304			Ø	I	H	€		
2-200-010	Inox/st-steel	SATINATO	30	500	75	€ 39,431	2	1,31



Ambidestro
ambidextrous
ambidextre
beidhändig

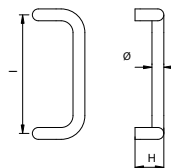

-Fissaggi vedi pag. 216

-Fixings - page 216

-Fixations voir - page 216

-Befestigung siehe - seite 216

2200 INOX 316L

ARTICOLO			Ø	L	H	B	€		
2-2141-015	Inox/st-steel	PVD	25	200	70	126	€ 170,325	2	1,27
2-2146-010	Inox/st-steel	Satinato	25	350	70	126	€ 84,982	2	1,73
2-2164-009	Inox/st-steel	Lucido	30	300	85	145	€ 75,834	2	1,62
2-2164-010	Inox/st-steel	Satinato	30	300	85	145	€ 73,065	2	1,62
2-2166-010	Inox/st-steel	Satinato	30	350	85	145	€ 75,593	2	1,77
2-2182-010	Inox/st-steel	Satinato	35	350	85	145	€ 84,018	2	2,05
2-2182-015	Inox/st-steel	PVD	35	350	85	145	€ 267,826	2	2,05
2-2186-010	Inox/st-steel	Satinato	35	650	85	145	€ 97,862	2	3,03

Categoria commerciale: 4D

INOX 304			Ø	L	H	B	€		
2-246-010	Inox/st-steel	Satinato	30	350	85		€ 28,162	2	0,89

SPECIALI			Ø	L	H	B	€		
SP-2200-Ø-I	Inox	Lucido	su richiesta	su richiesta	su richiesta	su richiesta			
SP-2200-Ø-I	Inox	Satinato	su richiesta	su richiesta	su richiesta	su richiesta			
SP-2200-Ø-I	Inox	PVD	su richiesta	su richiesta	su richiesta	su richiesta			

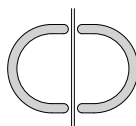

Ambidestro
ambidextrous
ambidextre
beidhändig

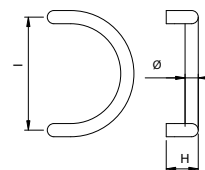

-Fissaggi vedi pag. 216

-Fixings - page 216

-Fixations voir - page 216

-Befestigung siehe - seite 216

2600 INOX 316L

ARTICOLO			Ø	L	H	B	€		
2-6165-010	Inox/st-steel	Satinato	30	300	85	225	€ 77,640	2	1,78
2-6165-015	Inox/st-steel	PVD	30	300	85	225	€ 161,056	2	1,78
2-6167-010	Inox/st-steel	Satinato	30	350	85	245	€ 82,695	2	1,96
2-6183-010	Inox/st-steel	Satinato	35	300	85	230	€ 80,769	2	2,05
2-6185-010	Inox/st-steel	Satinato	35	350	85	260	€ 87,148	2	2,31
2-6185-015	Inox/st-steel	PVD	35	350	85	260	€ 251,214	2	2,31

Categoria commerciale: 4D

INOX 304			Ø	L	H	B	€		
2-224-010	Inox/st-steel	Satinato	30	350	85		€ 31,542	2	0,98

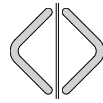

Ambidestro
ambidextrous
ambidextre
beidhändig

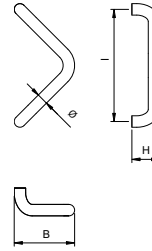

-Fissaggi vedi pag. 216
-Fixings - page 216
-Fixations voir - page 216
-Befestigung siehe - seite 216

2700 INOX 316L

ARTICOLO			Ø	L	H	B	€		
2-7163-010	Inox/st-steel	Satinato	30	300	85	159	€ 71,139	2	1,45
2-7165-010	Inox/st-steel	Satinato	30	350	85	184	€ 74,029	2	1,64
2-7185-010	Inox/st-steel	Satinato	35	350	85	188	€ 79,926	2	1,87
2-7188-010	Inox/st-steel	Satinato	35	425	85	226	€ 84,380	2	2,19

Categoria commerciale: 4D

INOX 304			Ø	L	H	B	€		
2-251-010	Inox/st-steel	Satinato	30	350	85		€ 31,542	2	0,32



Sinistro
left
gauche
links

Destro
right
droite
rechts

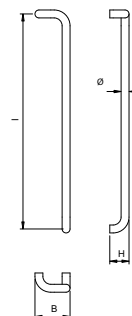

-Fissaggi vedi pag. 216
-Fixings - page 216
-Fixations voir - page 216
-Befestigung siehe - seite 216

2800 INOX 316L

ARTICOLO			Ø	L	H	B	€		
2-8166-010	Inox/st-steel	Satinato	30	1200	85	145	€ 125,908	1DX	2,02
2-8166-010	Inox/st-steel	Satinato	30	1200	85	145	€ 125,908	1SX	2,02
2-8186-010	Inox/st-steel	Satinato	35	1200	85	155	€ 131,686	1DX	2,30
2-8186-010	Inox/st-steel	Satinato	35	1200	85	155	€ 131,686	1SX	2,30

Categoria commerciale: 4D

SPECIALI			Ø	L	H	B	€		
SP-2800-Ø-I	Inox	Lucido	su richiesta	su richiesta	su richiesta	su richiesta			
SP-2800-Ø-I	Inox	Satinato	su richiesta	su richiesta	su richiesta	su richiesta			
SP-2800-Ø-I	Inox	PVD	su richiesta	su richiesta	su richiesta	su richiesta			



Ambidestro
ambidextrous
ambidextre
beidhändig

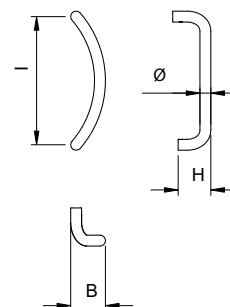

-Fissaggi vedi pag. 216
-Fixings - page 216
-Fixations voir - page 216
-Befestigung siehe - seite 216

2900 INOX 316L

ARTICOLO			\varnothing	I	H	B	€		
2-9165-010	Inox/st-steel	Satinato	30	350	85	98	€ 63,195	2	1,45
2-9185-010	Inox/st-steel	Satinato	35	350	85	103	€ 72,825	2	1,65

Categoria commerciale: 4D



Ambidestro
ambidextrous
ambidextre
beidhändig

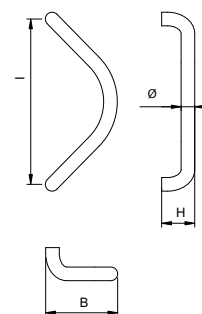

-Fissaggi vedi pag. 216
-Fixings - page 216
-Fixations voir - page 216
-Befestigung siehe - seite 216

2902 INOX 316L

ARTICOLO			\varnothing	I	H	B	€		
2-9262-010	Inox/st-steel	Satinato	30	300	85	180	€ 70,778	2	1,58
2-9265-010	Inox/st-steel	Satinato	30	425	85	180	€ 75,472	2	1,83
2-9283-009	Inox/st-steel	Lucido	35	350	85	185	€ 84,501	2	1,90
2-9283-010	Inox/st-steel	Satinato	35	350	85	185	€ 81,732	2	1,90
2-9283-015	Inox/st-steel	PVD	35	350	85	185	€ 278,602	2	1,90

Categoria commerciale: 4D

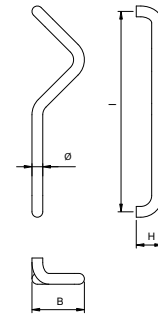
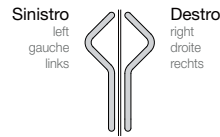

-Fissaggi vedi pag. 216
-Fixings - page 216
-Fixations voir - page 216
-Befestigung siehe - seite 216

3000 INOX 316L

ARTICOLO			Ø	I	H	B	€		
3-0166-010 DX	Inox/st-steel	Satinato	30	650	85	165	€ 88,954	1	1,24
3-0166-010 SX	Inox/st-steel	Satinato	30	650	85	165	€ 88,954	1	1,24

Categoria commerciale: 4D

SPECIALI			Ø	I	H	B	€
SP-3000-Ø-I	Inox	Lucido	su richiesta	su richiesta	su richiesta	su richiesta	
SP-3000-Ø-I	Inox	Satinato	su richiesta	su richiesta	su richiesta	su richiesta	
SP-3000-Ø-I	Inox	PVD	su richiesta	su richiesta	su richiesta	su richiesta	

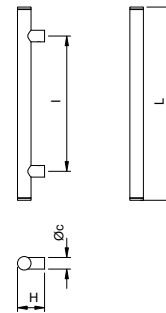
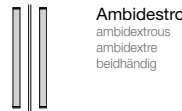

-Fissaggi vedi pag. 216
-Fixings - page 216
-Fixations voir - page 216
-Befestigung siehe - seite 216

4000 INOX 316L

ARTICOLO			Ø	I	L	H	Øc	€		
4-0042-009	Inox/st-steel	Lucido	25	300	450	70	25	€ 93,288	2	1,74
4-0042-010	Inox/st-steel	Satinato	25	300	450	70	25	€ 92,806	2	1,74
4-0064-010	Inox/st-steel	Satinato	30	350	500	75	25	€ 100,630	2	2,22
4-0066-010	Inox/st-steel	Satinato	30	500	650	75	25	€ 108,936	2	2,75
4-0068-010	Inox/st-steel	Satinato	30	650	800	75	25	€ 126,389	2	3,29

Categoria commerciale: 4D

INOX 304			Ø	I	H	B	€		
4-293-010	Inox/st-steel	Satinato	30	350	75		€ 36.052	2	1,11

SPECIALI			Ø	I	L	H	B	Øc	€
SP-4000-Ø-I	Inox	Lucido	su richiesta	su richiesta	su richiesta	su richiesta	su richiesta	su richiesta	
SP-4000-Ø-I	Inox	Satinato	su richiesta	su richiesta	su richiesta	su richiesta	su richiesta	su richiesta	
SP-4000-Ø-I	Inox	PVD	su richiesta	su richiesta	su richiesta	su richiesta	su richiesta	su richiesta	

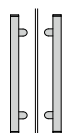

Ambidestro
ambidextrous
ambidextre
beidhändig

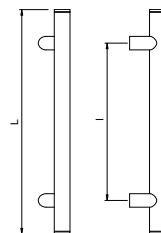

-Fissaggi vedi pag. 216
-Fixings - page 216
-Fixations voir - page 216
-Befestigung siehe - seite 216

4010 INOX 316L

ARTICOLO			Ø	I	L	H	Øc	B	€		
4-0164-010	Inox/st-steel	Satinato	30	350	500	75	25	54	€ 170,241	2	2,60
4-0168-010	Inox/st-steel	Satinato	30	650	800	75	25	54	€ 190,812	2	3,67
4-0185-010	Inox/st-steel	Satinato	35	500	650	80	30	54	€ 194,025	2	3,49

Categoria commerciale: 4D

SPECIALI			Ø	I	L	H	Øc	B	€
SP-4010-Ø-I	Inox	Lucido	su richiesta	su richiesta	su richiesta	su richiesta	su richiesta	su richiesta	
SP-4010-Ø-I	Inox	Satinato	su richiesta	su richiesta	su richiesta	su richiesta	su richiesta	su richiesta	
SP-4010-Ø-I	Inox	PVD	su richiesta	su richiesta	su richiesta	su richiesta	su richiesta	su richiesta	

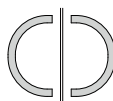

Ambidestro
ambidextrous
ambidextre
beidhändig

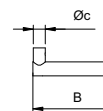
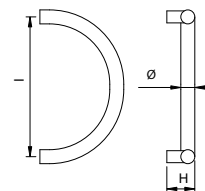

-Fissaggi vedi pag. 216
-Fixings - page 216
-Fixations voir - page 216
-Befestigung siehe - seite 216

4300 INOX 316L

ARTICOLO			Ø	I	H	Øc	B	€		
4-3064-010	Inox/st-steel	Satinato	30	300	75	25	175	€ 110,741	2	2,04
4-3085-010	Inox/st-steel	Satinato	35	350	80	30	210	€ 128,436	2	2,66

Categoria commerciale: 4D



Ambidestro
ambidextrous
ambidextre
beidhändig

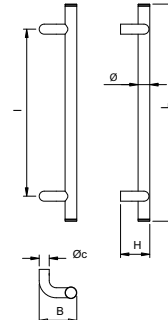

-Fissaggi vedi pag. 216
-Fixings - page 216
-Fixations voir - page 216
-Befestigung siehe - seite 216

4400 INOX 316L

ARTICOLO			Ø	I	L	H	Øc	B	€		
4-4062-009	inox/st-steel	lucido	30	350	500	85	25	108	€ 139,149	2	2,5
4-4062-010	inox/st-steel	satinato	30	350	500	85	25	108	€ 132,649	2	2,5
4-4064-010	inox/st-steel	satinato	30	500	650	85	25	108	€ 152,149	2	3,1
4-4082-010	inox/st-steel	satinato	35	350	500	88	30	113	€ 143,844	2	3,0
4-4084-010	inox/st-steel	satinato	35	500	650	88	30	113	€ 164,186	2	3,6
4-4088-010	inox/st-steel	satinato	35	900	1050	88	30	113	€ 192,594	2	5,2

Categoria commerciale: 4D

SPECIALI			Ø	I	L	H	B	€
SP-4400-Ø-I	Inox	Lucido	su richiesta	su richiesta	su richiesta	su richiesta	su richiesta	
SP-4400-Ø-I	Inox	Satinato	su richiesta	su richiesta	su richiesta	su richiesta	su richiesta	
SP-4400-Ø-I	Inox	PVD	su richiesta	su richiesta	su richiesta	su richiesta	su richiesta	

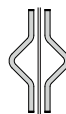

Ambidestro
ambidextrous
ambidextre
beidhändig

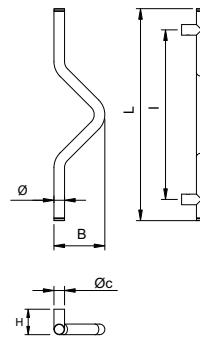

-Fissaggi vedi pag. 216
-Fixings - page 216
-Fixations voir - page 216
-Befestigung siehe - seite 216

4802 INOX 316L

ARTICOLO			Ø	I	L	H	Øc	B	€		
4-8244-010	inox/st-steel	satinato	25	400	500	70	25	120	€ 120,973	2	2,1

Categoria commerciale: 4D

SPECIALI			Ø	I	L	H	Øc	B	€
SP-4802-Ø-I	Inox	Lucido	su richiesta	su richiesta	su richiesta	su richiesta	su richiesta	su richiesta	
SP-4802-Ø-I	Inox	Satinato	su richiesta	su richiesta	su richiesta	su richiesta	su richiesta	su richiesta	
SP-4802-Ø-I	Inox	PVD	su richiesta	su richiesta	su richiesta	su richiesta	su richiesta	su richiesta	

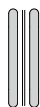
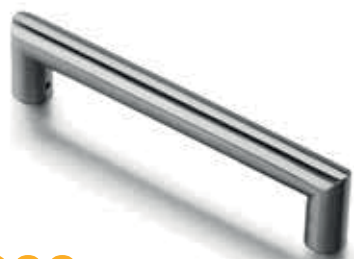

Ambidestro
ambidextrous
ambidextre
beidhändig

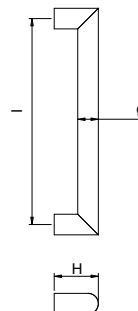

-Fissaggi vedi pag. 216
-Fixings - page 216
-Fixations voir - page 216
-Befestigung siehe - seite 216

5000 INOX 316L

ARTICOLO			Ø	I	H	€		
5-0025-010	inox/st-steel	satinato	20	350	60	€ 95,093	2	1,0
5-0045-010	inox/st-steel	satinato	25	300	65	€ 93,648	2	1,0
5-0085-010	inox/st-steel	satinato	35	350	75	€ 100,870	2	1,6
5-201-010	inox/st-steel	Satinato	30	350	70	€ 39,431	2	0,78

Categoria commerciale: 4D

INOX 304			Ø	I	H	B	€		
5-201-010	Inox/st-steel	Satinato	30	350	70		€ 39,431	2	0,78

SPECIALI			Ø	I	H	€
SP-5000-Ø-I	Inox	Lucido	su richiesta	su richiesta	su richiesta	
SP-5000-Ø-I	Inox	Satinato	su richiesta	su richiesta	su richiesta	
SP-5000-Ø-I	Inox	PVD	su richiesta	su richiesta	su richiesta	

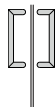

Ambidestro
ambidextrous
ambidextre
beidhändig

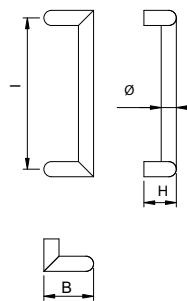

-Fissaggi vedi pag. 216
-Fixings - page 216
-Fixations voir - page 216
-Befestigung siehe - seite 216

5200 INOX 316L

ARTICOLO			Ø	I	H	B	€		
5-2046-010	inox/st-steel	satinato	25	350	65	65	€ 132,889	2	1,4
5-2066-010	inox/st-steel	satinato	30	350	70	70	€ 122,417	2	1,8
5-2086-010	inox/st-steel	satinato	35	350	75	75	€ 132,408	2	2,2

Categoria commerciale: 4D

SPECIALI			Ø	I	H	B	€
SP-5200-Ø-I	Inox	Lucido	su richiesta	su richiesta	su richiesta	su richiesta	
SP-5200-Ø-I	Inox	Satinato	su richiesta	su richiesta	su richiesta	su richiesta	
SP-5200-Ø-I	Inox	PVD	su richiesta	su richiesta	su richiesta	su richiesta	

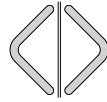

Ambidestro
ambidextrous
ambidextre
beidhändig

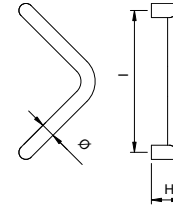

-Fissaggi vedi pag. 216
-Fixings - page 216
-Fixations voir - page 216
-Befestigung siehe - seite 216

5300 INOX 316L

ARTICOLO			Ø	L	H	€		
5-3085-010	inox/st-steel	satinato	35	350	75	€ 118,806	2	1,8

Categoria commerciale: 4D



Ambidestro
ambidextrous
ambidextre
beidhändig

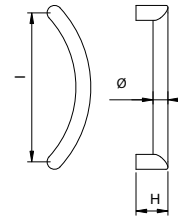

-Fissaggi vedi pag. 216
-Fixings - page 216
-Fixations voir - page 216
-Befestigung siehe - seite 216

5400 INOX 316L

ARTICOLO			Ø	L	H	B	€		
5-4043-010	inox/st-steel	satinato	25	250	60	64	€ 102,315	2	1,0
5-4062-010	inox/st-steel	satinato	30	300	70	78	€ 94,973	2	1,4
5-4062-015	inox/st-steel	pvd	30	300	70	78	€ 153,834	2	1,4
5-4065-009	inox/st-steel	lucido	30	350	70	84	€ 99,788	2	1,6
5-4065-010	inox/st-steel	satinato	30	350	70	84	€ 97,019	2	1,6
5-4068-010	inox/st-steel	satinato	30	600	70	145	€ 108,936	2	2,6
5-4082-010	inox/st-steel	satinato	35	350	75	89	€ 105,565	2	1,8
5-4082-015	inox/st-steel	pvd	35	350	75	89	€ 194,760	2	1,8
5-4085-010	inox/st-steel	satinato	35	500	75	123	€ 121,816	2	2,5
5-4088-010	inox/st-steel	satinato	35	700	75	148	€ 121,455	2	3,3

Categoria commerciale: 4D

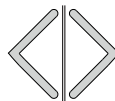

Ambidestro
ambidextrous
ambidextre
beidhändig

-Fissaggi vedi pag. 216
-Fixings - page 216
-Fixations voir - page 216
-Befestigung siehe - seite 216

5500 INOX 316L

ARTICOLO			Ø	L	H	€		
5-5063-010	inox/st-steel	satinato	30	300	70	€ 105,204	2	1,6

Categoria commerciale: 4D



Ambidestro
ambidextrous
ambidextre
beidhändig

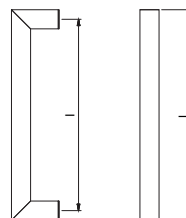

7000 INOX 316L

-Fissaggi vedi pag. 216

-Fixings - page 216

-Fixations voir - page 216

-Befestigung siehe - seite 216

SU RICHIESTA							€		
7-0064-010	inox/st-steel	satinato	30	300	330	75	€ 83,276	2	1,4
7-0086-010	inox/st-steel	satinato	30	650	680	75	€ 121,669	2	2,6

Categoria commerciale: 4D

SPECIALI							€
SP-7000-I	Inox	satinato	30	su richiesta		75	

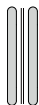

Ambidestro
ambidextrous
ambidextre
beidhändig

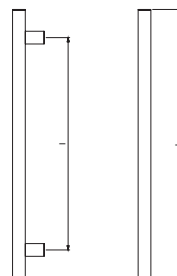

7100 INOX 316L

-Fissaggi vedi pag. 216

-Fixings - page 216

-Fixations voir - page 216

-Befestigung siehe - seite 216

SU RICHIESTA							€		
7-1066-010	inox/st-steel	satinato	30	500	650	75	€ 156,818	2	2,1

Categoria commerciale: 4D

SPECIALI							€
SP-7100-I	Inox	satinato	30	su richiesta		75	



Ambidestro
ambidextrous
ambidextre
beidhändig



-Fissaggi vedi pag. 199
-Fixings - page 199
-Fixations voir - page 199
-Befestigung siehe - seite 199

8000 INOX 316L

SU RICHIESTA			\emptyset	I	L	H	€		
8-0048-010	inox/st-steel	satinato	40x20	350	370	65	€ 133,025	2	1,4
8-0086-010	inox/st-steel	satinato	40x20	650	670	65	€ 143,840	2	2,1

Categoria commerciale: 4D



Ambidestro
ambidextrous
ambidextre
beidhändig



-Fissaggi vedi pag. 199
-Fixings - page 199
-Fixations voir - page 199
-Befestigung siehe - seite 199

8100 INOX 316L

SU RICHIESTA			\emptyset	I	L	H	€		
8-1048-010	inox/st-steel	satinato	40x20	350	390	85	€ 133,025	2	1,4
8-1086-010	inox/st-steel	satinato	40x20	650	690	85	€ 143,840	2	2,1

Categoria commerciale: 4D



Ambidestro
ambidextrous
ambidextre
beidhändig

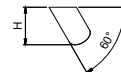

-Fissaggi vedi pag. 199
-Fixings - page 199
-Fixations voir - page 199
-Befestigung siehe - seite 199

8150 INOX 316L

SU RICHIESTA			\emptyset	I	L	H	€		
8-1548-010	inox/st-steel	satinato	40x20	350	370	65	€ 196,617	2	1,4
8-1586-010	inox/st-steel	satinato	40x20	650	670	65	€ 209,703	2	2,1

Categoria commerciale: 4D

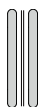

Ambidestro
ambidextrous
ambidextre
beidhändig

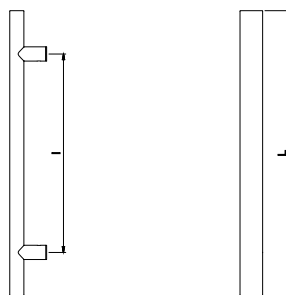

-Fissaggi vedi pag. 199

-Fixings - page 199

-Fixations voir - page 199

-Befestigung siehe - seite 199

8200 INOX 316L

SU RICHIESTA							€		
8-2048-010	inox/st-steel	satinato	40x20	350	500	65	€ 158,115	2	1,700
8-2087-010	inox/st-steel	satinato	40x20	550	700	65	€ 173,040	2	2,200

Categoria commerciale: 4D

SPECIALI							€
SP-8200-I	Inox	satinato	40x20	su richiesta	65		



Ambidestro
ambidextrous
ambidextre
beidhändig

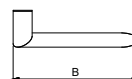
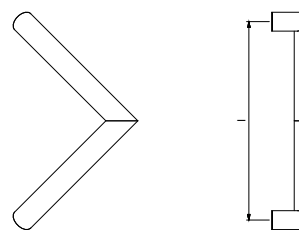

-Fissaggi vedi pag. 199

-Fixings - page 199

-Fixations voir - page 199

-Befestigung siehe - seite 199

8300 INOX 316L

SU RICHIESTA							€		
8-3048-010	inox/st-steel	satinato	40x20	350	220	65	€ 146,868	2	1,7
8-3088-010	inox/st-steel	satinato	40x20	425	255	65	€ 159,738	2	2,0

Categoria commerciale: 4D



Ambidestro
ambidextrous
ambidextre
beidhändig

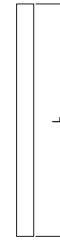
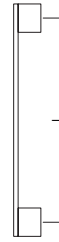

-Fissaggi vedi pag. 199
-Fixings - page 199
-Fixations voir - page 199
-Befestigung siehe - seite 199

9000 INOX 316L

SU RICHIESTA							€		
9-0048-010	inox/st-steel	satinato	30x8	350	400	48	€ 157,683	2	3,4
9-0087-010	inox/st-steel	satinato	30x8	550	600	48	€ 166,875	2	4,2

Categoria commerciale: 4D



Ambidestro
ambidextrous
ambidextre
beidhändig

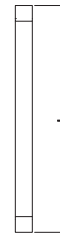
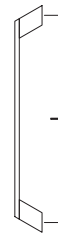

-Fissaggi vedi pag. 199
-Fixings - page 199
-Fixations voir - page 199
-Befestigung siehe - seite 199

9100 INOX 316L

SU RICHIESTA							€		
9-1048-010	inox/st-steel	satinato	30x8	350	400	48	€ 153,897	2	2,6
9-1087-010	inox/st-steel	satinato	30x8	550	600	48	€ 164,712	2	3,4

Categoria commerciale: 4E

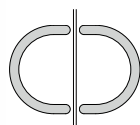

Ambidestro
ambidextrous
ambidextre
beidhändig

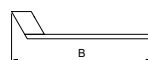
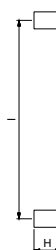
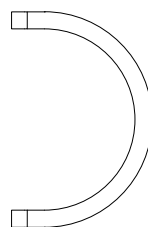

9150 INOX 316L

-Fissaggi vedi pag. 216

-Fixings - page 216

-Fixations voir - page 216

-Befestigung siehe - seite 216

SU RICHIESTA							€		
9-1548-010	inox/st-steel	satinato	30x8	350	250	48	€ 179,529	2	3,600

Categoria commerciale: 4D



Ambidestro
ambidextrous
ambidextre
beidhändig



9200 INOX 316L

-Fissaggi vedi pag. 216

-Fixings - page 216

-Fixations voir - page 216

-Befestigung siehe - seite 216

SU RICHIESTA							€		
9-2048-010	inox/st-steel	satinato	30x8	350	500	60	€ 152,492	2	3,2
9-2087-010	inox/st-steel	satinato	30x8	550	700	60	€ 161,144	2	4,0

Categoria commerciale: 4D

SPECIALI						€
SP-9200-I	Inox	satinato	30x8	su richiesta	60	



Ambidestro
ambidextrous
ambidextre
beidhändig



9300 INOX 316L

-Fissaggi vedi pag. 216

-Fixings - page 216

-Fixations voir - page 216

-Befestigung siehe - seite 216

SU RICHIESTA							€		
9-3066-010	inox/st-steel	satinato	30x8	500	100	48	€ 170,228	2	3,2
9-3089-010	inox/st-steel	satinato	30x8	700	110	48	€ 179,529	2	4,0

Categoria commerciale: 4D



Ambidestro
ambidextrous
ambidextre
beidhändig

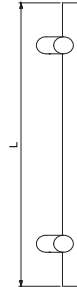

-Fissaggi vedi pag. 216
-Fixings - page 216
-Fixations voir - page 216
-Befestigung siehe - seite 216

9400 INOX 316L

SU RICHIESTA							€		
9-4048-010	inox/st-steel	satinato	30x8	350	500	48	€ 152,492	2	3,1
9-4087-010	inox/st-steel	satinato	30x8	550	700	48	€ 161,144	2	3,9

Categoria commerciale: 4D

SPECIALI							€
SP-9400-I	Inox	satinato	30x8	su richiesta		48	

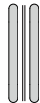

Ambidestro
ambidextrous
ambidextre
beidhändig



-Fissaggi vedi pag. 216
-Fixings - page 216
-Fixations voir - page 216
-Befestigung siehe - seite 216

9500 INOX 316L

SU RICHIESTA							€		
9-5048-010	inox/st-steel	satinato	30x8	350	500	48	€ 124,373	2	2,9
9-5087-010	inox/st-steel	satinato	30x8	550	700	48	€ 136,161	2	3,7

Categoria commerciale: 4D



Ambidestro
ambidextrous
ambidextre
beidhändig

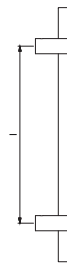

-Fissaggi vedi pag. 216
-Fixings - page 216
-Fixations voir - page 216
-Befestigung siehe - seite 216

9600 INOX 316L

SU RICHIESTA							€		
9-6048-010	inox/st-steel	satinato	30	350	500	80	€ 174,122	2	2,400
9-6087-010	inox/st-steel	satinato	30	550	700	80	€ 180,611	2	2,700

Categoria commerciale: 4D



Ambidestro
ambidextrous
ambidextre
beidhändig

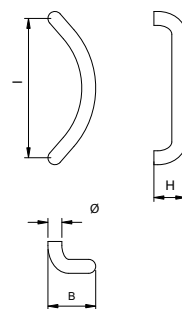

-Fissaggi vedi pag. 216
-Fixings - page 216
-Fixations voir - page 216
-Befestigung siehe - seite 216

6300 NYLON

ARTICOLO							€		
6-3085-9005	nylon	nero	35	350	80	120	€ 25,880	2	1,0

Categoria commerciale: 4H

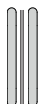

Ambidestro
ambidextrous
ambidextre
beidhändig

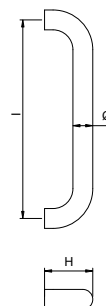

-Fissaggi vedi pag. 216
-Fixings - page 216
-Fixations voir - page 216
-Befestigung siehe - seite 216

6400 NYLON

ARTICOLO						€		
6-4065-9005	nylon	nero	30	225	80	€ 23,473	2	0,6
6-4085-9005	nylon	nero	35	350	80	€ 25,880	2	1,1

Categoria commerciale: 4H



Ambidestro
ambidextrous
ambidextre
beidhändig

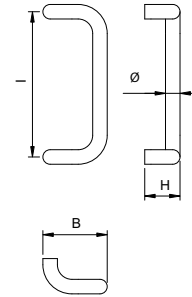

-Fissaggi vedi pag. 216
-Fixings - page 216
-Fixations voir - page 216
-Befestigung siehe - seite 216

6500 NYLON

ARTICOLO			\emptyset	L	H	B	€		
6-5085-9005	nylon	nero	35	350	80	140	€ 25,880	2	1,2
6-5085-9010	nylon	bianco	35	350	80	140	€ 29,250	2	1,2

Categoria commerciale: 4H

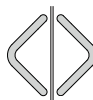

Ambidestro
ambidextrous
ambidextre
beidhändig

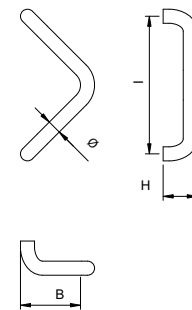

-Fissaggi vedi pag. 216
-Fixings - page 216
-Fixations voir - page 216
-Befestigung siehe - seite 216

6700 NYLON

ARTICOLO			\emptyset	L	H	B	€		
6-7085-9005	nylon	nero	35	425	80	226	€ 30,213	2	1,8

Categoria commerciale: 4H

PORTE IN VETRO

Glass door / Glasstüren
Puertas de vidrio / Portes en verre



APPLICAZIONE SINGOLA

Single application
Einseitige Befestigung
Aplicación simple
Application single



APPLICAZIONE DOPPIA

Double application
Paarweise Befestigung
Aplicación doble
Application double



Ø Maniglione	Nylon
Ø 20mm	-
Ø 25mm	-
Ø 30mm	F0026 B/N
Ø 35mm	F0028 B/N
Altre sezioni	-

Ø 20mm	-
Ø 25mm	-
Ø 30mm	F1016 24H
Ø 35mm	F1018 24H
Altre sezioni	-

PORTE CON PROFILO TUBOLARE

Tubular profile
Rohrprofile
Puertas con perfil tubular
Profils tubulaires

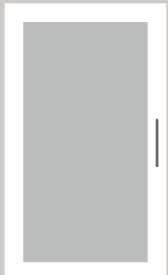

APPLICAZIONE SINGOLA

Single application
Einseitige Befestigung
Aplicación simple
Application single



Aggancio rapido

Rapid installation
Schnellkupplung
Enganche rápido
Attelage rapide

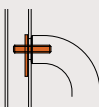

Foro passante con tappo

Through hole with plug
Durchgangsbohrung mit Stopfen
Agujero pasante con tapón
Trou passant avec bouchon



A fresatura

To be milled
À fraisage
Gefräst

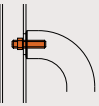

Tripla camera

Three-chamber
Tripelkammer
Triple cámara
Triple chambre

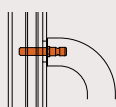

Con placca

With plate
Mit Platte
Con placa
Avec rosace

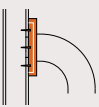

APPLICAZIONE DOPPIA

Double application
Paarweise Befestigung
Aplicación doble
Application double



Ø 20mm	-
Ø 25mm	-
Ø 30mm	F1116 24H
Ø 35mm	F0068 24H
Altre sezioni	-

Ø 20mm	-
Ø 25mm	-
Ø 30mm	F0046
Ø 35mm	F0048 24H
Altre sezioni	-

Ø 20mm	-
Ø 25mm	-
Ø 30mm	F0036
Ø 35mm	F0038
Altre sezioni	-

Ø 20mm	-
Ø 25mm	-
Ø 30mm	-
Ø 35mm	-
Altre sezioni	-

Ø 20mm	-
Ø 25mm	-
Ø 30mm	F0056 B/N
Ø 35mm	F0058 B/N 24H
Altre sezioni	-

Ø 20mm	-
Ø 25mm	-
Ø 30mm	F0016 24H
Ø 35mm	F0018 24H
Altre sezioni	-

Alluminio	Inox	2100	Inox <small>SERIE 8000</small>
F7022 B/N	F1022 L/S/PVD	-	-
F7024 B/N	F1325 L/S/PVD	-	-
F7026 B/N	F1330 L/S/PVD 24H	-	-
F7028 B/N	F1335 L/S/PVD	-	-
-	-	-	-
F1012	F1012	-	-
F7014	F2001 24H	F1084	-
F7016 24H	F2001 24H	F7016	-
F7016 24H	F2001 24H	-	-
-	F2001 24H	-	F1012
-	-	-	-
F1112	F1112	-	-
F1114	F1000 24H	-	-
F1116 24H	F1000 24H	F1116 24H	-
F1116 24H	F1000 24H	-	-
-	F1000 24H	-	-
-	-	-	-
F1042	F1042	-	-
F7044	F1200 24H	-	-
F7046 24H	F1200 24H	F7046 24H	-
F7046 24H	F1200 24H	-	-
-	F1200 24H	-	F1042
-	-	-	-
F1032	F1032	-	-
F7044	F1200 24H	F1094	-
F7046	F1200 24H	F7036 24H	-
F7046	F1200 24H	-	-
-	F1200 24H	-	F1032
-	-	-	-
F1119	F1400	-	-
F1120	F1400	F1120	-
F1120	F1400	-	-
-	F1400	-	-
-	-	-	-
F7052 B/N	F1052 L/S/PVD	-	-
F7054 B/N	F3025 L/S/PVD	-	-
F7056 B/N/ANS	F3030 L/S/PVD 24H	-	-
F7056 B/N/ANS	F3035 L/S/PVD	-	-
-	-	-	-
-	-	-	-
F1012	F1012	-	-
F7014	F2000 24H	F1084	-
F7016 24H	F2000 24H	F7016 24H	-
F7016 24H	F2000 24H	-	-
-	F2000 24H	-	F1012

Finiture Finishing - Finitions - Ausführungen

BORCHIE SEMISFERICHE
Semispherical studs - Halbrunde Zierplättchen -
Resbalones semiesféricos - Caches hémisphériques

B:	Bianco / White
N:	Nero / Black
L:	Lucido / Polished
S:	Satinato / Satin
PVD:	PVD / Polished PVD



Finiture Finishing - Finitions - Ausführungen

PLACCHE
Door knob base rings - Abschlussringe - Placas -
Rosaces

B:	Bianco / White
N:	Nero / Black
L:	Lucido / Polished
S:	Satinato / Satin
ANS:	Anod. argento sat. / Silver sat. anod.
PVD:	PVD / Polished PVD



F0016

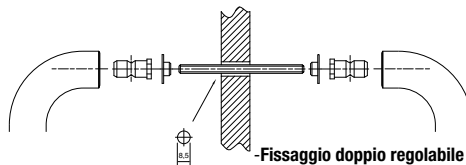

-Fissaggio doppio regolabile per maniglioni in nylon su profili tubolari e porte in vetro

-Adjustable double fixing for nylon pull-handles on tubular profiles and glass doors

-Fixation double réglable pour poignées en nylon, sur profils tubulaires et portes en verre

-Verstellbares Montageset paarweise für Nylonstosssgriffe auf röhrenförmigen Profilen und Ganzglastüren

F0016	30	nylon	€ 7,222	1	0,2

Categoria commerciale: 4B

F0018

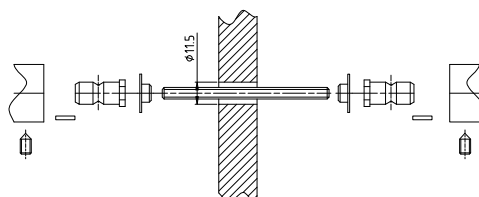

-Fissaggio doppio regolabile per maniglioni in nylon su profili tubolari e porte in vetro

-Adjustable double fixing for nylon pull-handles on tubular profiles and glass doors

-Fixation double réglable pour poignées en nylon, sur profils tubulaires et portes en verre

-Verstellbares Montageset paarweise für Nylonstosssgriffe auf röhrenförmigen Profilen und Ganzglastüren

F0018	35	nylon	€ 7,825	1	0,2

Categoria commerciale: 4B

F0036 - F0038

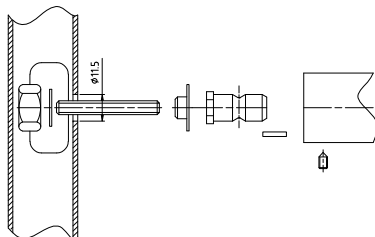

-Fissaggio singolo a fresatura per profili tubolari

-Single fixing by means of milling for tubular profiles

-Fixation simple à fraisage pour profils tubulaires

-Montageset einseitig zum Einfräsen für röhrenförmige Profile

F0036 <i>24h</i>	30	nylon	€ 3,611	1	0,1
F0038 <i>24h</i>	35	nylon	€ 4,214	1	0,1

Categoria commerciale: 4B

F0046

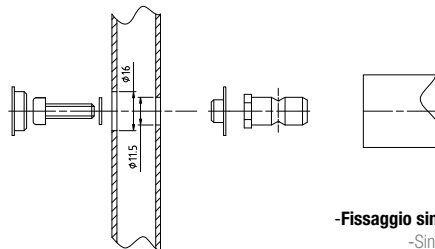

-Fissaggio singolo per porte con profilo tubolare- Foro passante con tappo

-Single attachment for doors with tubular profile - Through hole with cap

-Einzelbefestigung für Türen mit Rohrprofil - durchgehende Bohrung mit Verschluss

-Fixation simple pour portes avec profil tubulaire - Trou traversant avec bouchon

F0046	30	nylon	€ 4,214	1	0,1

Categoria commerciale: 4B

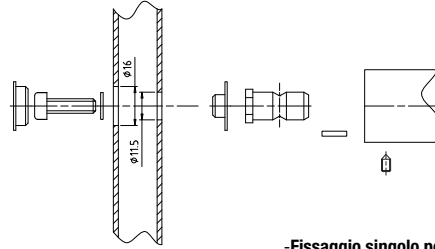

-Fissaggio singolo per porte con profilo tubolare- Foro passante con tappo
 -Single attachment for doors with tubular profile - Through hole with cap
 -Einzelbefestigung für Türen mit Rohrprofil - durchgehende Bohrung mit Verschluss
 -Fixation simple pour portes avec profil tubulaire - Trou traversant avec bouchon

F0048

F0048	35	nylon	€ 4,214	1	0,1

Categoria commerciale: 4B

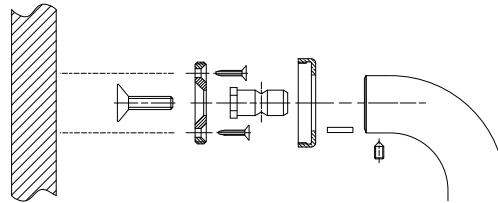

-Fissaggio singolo con placca in nylon per profili tubolari
 -Single fixing with nylon plate for tubular profiles
 -Fixation avec rosace en nylon pour profils tubulaires
 -Montageset einseitig mit Rosette aus Nylon für röhrenförmige Profile

F0056 - F0058

F0056N <i>24h</i>	30	nylon	nero	€ 7,222	1	0,1
F0056B <i>24h</i>	30	nylon	bianco	€ 7,222	1	0,1
F0058N <i>24h</i>	35	nylon	nero	€ 7,825	1	0,1
F0058B <i>24h</i>	35	nylon	bianco	€ 7,825	1	0,1

Categoria commerciale: 4B

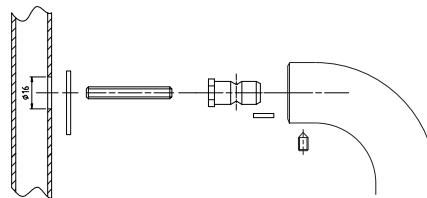
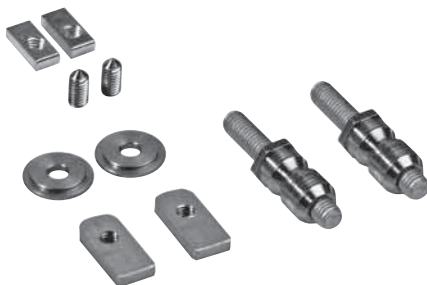

-Fissaggio singolo ad aggancio rapido per profili tubolari
 -Single fixing with fast hooking for tubular profiles
 -Fixation simple avec accrochage rapide pour profils tubulaires
 -Montageset einseitig mit schneller Kupplung für röhrenförmige Profile

F0068

F0068 <i>24h</i>	35	nylon	€ 9,028	1	0,850

Categoria commerciale: 4B

F1000

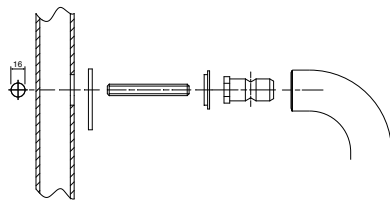

-Fissaggio unificato singolo ad aggancio rapido per profili tubolari

-Single fixing with fast hooking for tubular profiles

-Fixation simple avec accrochage rapide pour profils tubulaires

-Montageset einseitig mit schneller Kupplung für röhrenförmige Profile

F1000	25-30-35	inox	€ 11,411	1	0,1

Categoria commerciale: 4B

F1012

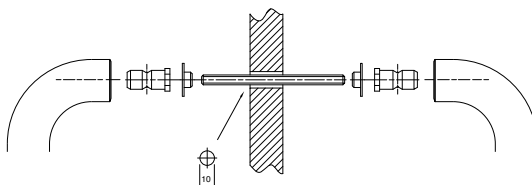
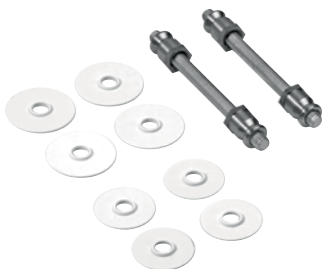

-Fissaggio unificato doppio regolabile per porte in vetro

-Double fixing adjustable for glass ones available for all diameters

-Verstellbares Montageset paarweise für Ganzglastüren für alle stossgriffdurchmesser geeignet

-Fixation double réglable pour toutes portes en verre vaiale pour tous less diametrès

F1012	20	alluminio-inox-serie 8000	€ 9,028	1	0,2

Categoria commerciale: 4B

F1042

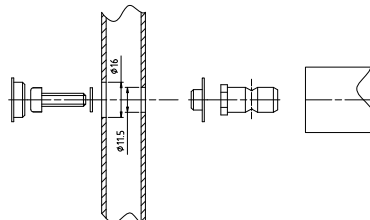

-Fissaggio unificato singolo con tappo per profili tubolari

-Fixing with plug except for glass doors available for all diameters (through hole)

-Montageset zum Durchschrauben mit Blindrosette für alle stossgriffdurchmesser geeignet (durchgehendes Loch)es

-Fixation avec bouchon pour portes bois ou métal vaiale pour tous less diametrès (trou passant)

F1042	20	alluminio-inox-serie 8000	€ 5,417	1	0,1

Categoria commerciale: 4B

F1100

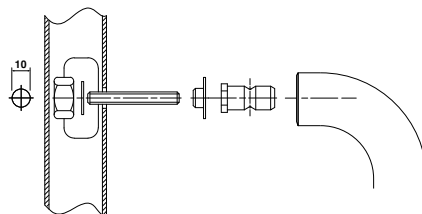

-Fissaggio unificato singolo a fresatura per profili tubolari

-Single fixing by means of milling for tubular profiles

-Fixation simple à fraisage pour profils tubulaires

-Montageset einseitig zum Einfräsen für röhrenförmige Profile

F1100	25-30-35	inox	€ 5,115	1	0,1

Categoria commerciale: 4B



F1114 - F1116

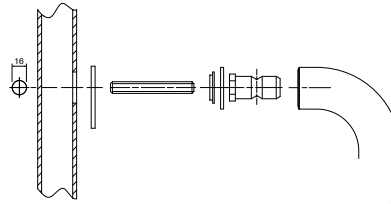

-Fissaggio singolo ad aggancio rapido per profili tubolari
-Single fixing with fast hooking for tubular profiles
-Fixation simple avec accrochage rapide pour profils tubulaires
-Montageset einseitig mit schneller Kupplung für röhrenförmige Profile

Icona	Ø	Materiali	Prezzo	Quantità	Peso
F1114	25	nylon Ø30-serie 2100 Ø25-alluminio	€ 9,233	1	0,7
F1116	30	nylon Ø30-serie 2100 Ø30-alluminio	€ 9,533	1	0,85

Categoria commerciale: 4B



F1119 - F1120

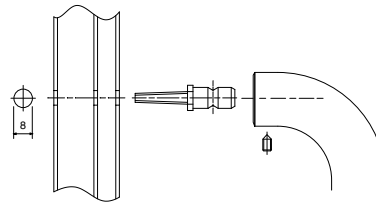

-Fissaggio singolo per profili tripla camera (Serie 2100 Inox)
-Single fixing for profiles with triple chamber (Serie 2100 Inox)
-Einzelbefestigung für 3-kammerprofile (Serie 2100 Inox)
-Fixation simple pour profils à trois chambres (Serie 2100 Inox)

Icona	Ø	Materiali	Prezzo	Quantità	Peso
F1119	25	serie 2100 Ø25-alluminio	€ 20,175	1	0,1
F1120	30	serie 2100 Ø30-alluminio	€ 20,174	1	0,1

Categoria commerciale: 4B



F1200

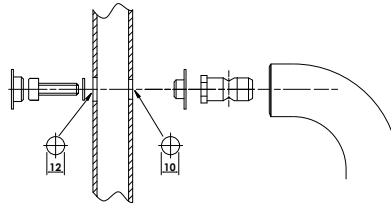

-Fissaggio unificato singolo con tappo per profili tubolari (foro passante)
-Single fixing with plug except for tubular profiles (through hole)
-Fixation simple avec bouchon pour profils tubulaires (trou passant)
-Montageset einseitig mit Stöpsel für röhrenförmigen Profilen (durchgehendes Loch)

Icona	Ø	Materiali	Prezzo	Quantità	Peso
F1200	25-30-35	inox	€ 6,019	1	0,2

Categoria commerciale: 4B



F1300

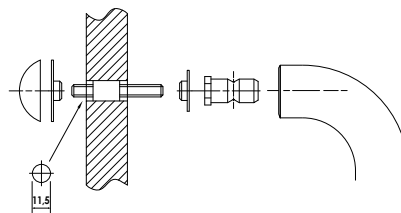

-Fissaggio singolo per porte in vetro (foro passante)
-Single fixing for glass doors (through hole)
-Fixation simple pour en verre vaiable (trou passant)
-Montageset einseitig für Ganzglastüren (durchgehendes Loch)

Icona	Ø	Materiali	Finitura	Prezzo	Quantità	Peso
F1325L	25	inox	lucido	€ 15,047	1	0,10
F1325PVD	25	inox	pvd	€ 15,047	1	0,10
F1325S	25	inox	satinato	€ 15,047	1	0,10
F1330L	30	inox	lucido	€ 17,153	1	0,10
F1330PVD	30	inox	pvd	€ 17,153	1	0,10

Icona	Ø	Materiali	Finitura	Prezzo	Quantità	Peso
F1330S	30	inox	satinato	€ 17,153	1	0,10
F1335L	35	inox	lucido	€ 19,886	1	0,10
F1335PVD	35	inox	pvd	€ 19,886	1	0,10
F1335S	35	inox	satinato	€ 19,886	1	0,10

Categoria commerciale: 4B

F1400

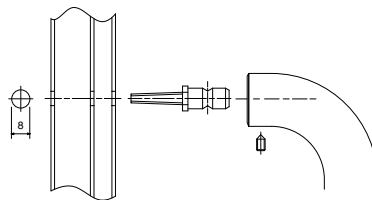

-Fissaggio singolo per profili tripla camera
 -Single fixing for profiles with triple chamber
 -Einzelbefestigung für 3-kammerprofile
 -Fixation simple pour profils à trois chambres

F1400	25-30-35	inox	€ 19,560	1	0,1

Categoria commerciale: 4B

F2000

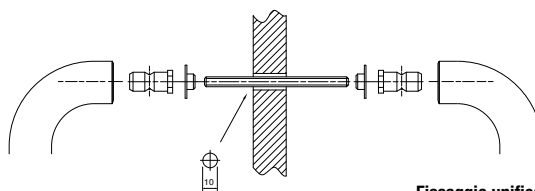

-Fissaggio unificato doppio regolabile per profili tubolari
 -Adjustable double fixing for tubular profiles
 -Fixation double réglable pour profils tubulaires
 -Verstellbares Montageset paarweise für röhrenförmige Profile

F2000	25-30-35	inox	€ 8,727	1	0,1

Categoria commerciale: 4B

F2001

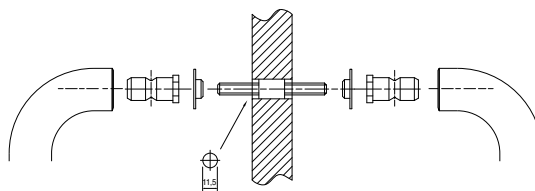

-Fissaggio unificato doppio regolabile per porte in vetro
 -Adjustable double fixing for glass doors
 -Fixation double réglable pour portes en verre
 -Verstellbares Montageset paarweise für Ganzglastüren

F2001	25-30-35	inox	€ 11,495	1	0,1

Categoria commerciale: 4B

F3000

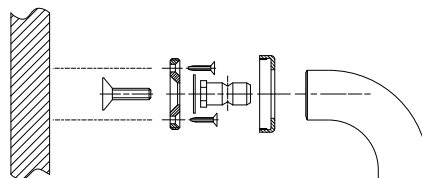

-Fissaggio singolo con placca metallica per profili tubolari
 -Fixing with metal plate except for glass doors
 -Montageset zum Aufschrauben mit Rosette (nicht fuer Ganzglastüren)
 Fixation avec rosace métallique pour portes bois ou métal

F3025L	25	inox	lucido	€ 18,633	1	0,20
F3025PVD	25	inox	pvd	€ 18,633	1	0,20
F3025S	25	inox	satinato	€ 18,633	1	0,20
F3030L	30	inox	lucido	€ 21,089	1	0,30
F3030PVD	30	inox	pvd	€ 21,089	1	0,30

F3030S	30	inox	satinato	€ 21,089	1	0,30
F3035L	35	inox	lucido	€ 21,089	1	0,30
F3035PVD	35	inox	pvd	€ 21,089	1	0,30
F3035S	35	inox	satinato	€ 21,089	1	0,30

Categoria commerciale: 4B

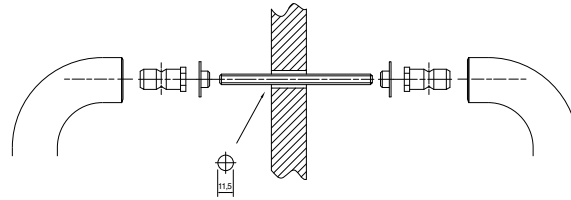
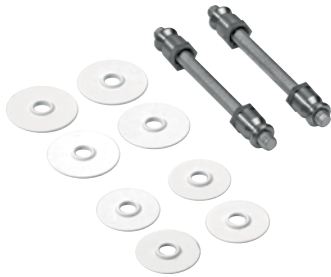

F7014 - F7016

-Fissaggio doppio regolabile per profili tubolari e porte in vetro
-Adjustable double fixing for tubular profiles and glass doors
-Fixation double réglable pour profils tubulaires et portes en verre
-Verstellbares Montageset paarweise für röhrenförmige Profile und Ganzglastüren

Icona	Ø	Materiali	Prezzo	Quantità	Accessori
	25	alluminio	€ 6,621	1	0,2
	30-35	alluminio	€ 7,825	1	0,2

Categoria commerciale: 4B

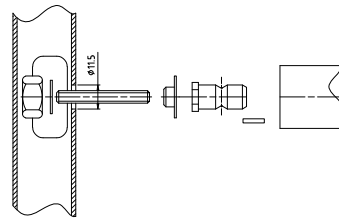

F7034 - F7036

-Fissaggio singolo a fresatura per profili tubolari
-Single fixing by means of milling for tubular profiles
-Fixation simple à fraisage pour profils tubulaires
-Montageset einseitig zum Einfräsen für röhrenförmige Profile

Icona	Ø	Materiali	Prezzo	Quantità	Accessori
	25	alluminio, inox 2100 ø25	€ 4,214	1	0,1
	30-35	alluminio, inox 2100 ø30	€ 4,214	1	0,1

Categoria commerciale: 4B

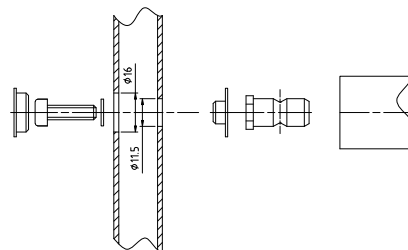

-Fissaggio unificato singolo con tappo per profili tubolari - Serie 2100 Inox
-Fixing with plug except for glass doors available for all diameters (through hole) - Serie 2100 Inox
-Montageset zum Durchschrauben mit Blindrossette für alle stossgriffdurchmesser geeignet (durchgehendes Loch) - Serie 2100 Inox
-Fixation avec bouchon pour portes bois ou métal valable pour tous les diamètres (trou passant) - Serie 2100 Inox

F7044 - F7046

Icona	Ø	Materiali	Prezzo	Quantità	Accessori
	25	serie 2100 ø 25-alluminio	€ 4,214	1	0,1
	30-35	serie 2100 ø 30-alluminio	€ 4,214	1	0,1

Categoria commerciale: 4B

Life
made
easy

COMUNELLO^K

FRAME AUTOMATION







W-NET Technology





LEGENDA

-  Articolo / Article
-  Finitura / Finishing
-  Pezzi per confezione / Pieces per pack
-  Peso confezione / Weight of pack
-  Prezzo / Price

Dalla potenza all'atto, dall'ape

01 SMART



Attuatore elettrico a catena per apertura e chiusura di finestre a sporgere, shed, lucernai, vasistas in legno, PVC e alluminio
Chain actuator for opening and closing top-hung outward windows, shed, skylights and bottom-hung inward windows in wood, PVC and aluminium



02 LIWIN



Attuatore elettrico a catena per apertura e chiusura di finestre a sporgere, shed, lucernai, vasistas in legno, PVC e alluminio
Chain actuator for opening and closing top-hung outward windows, shed, skylights and bottom-hung inward windows in wood, PVC and aluminium



05 AIRWIN



Attuatore elettrico a cremagliera per apertura e chiusura di shed, lucernai, pale frangisole e cupole
Rack actuator for opening and closing shed top-hung outward windows, skylights, solar shading blades and domes



06 NEW SPIN



Attuatore per serrande avvolgibili ad uso commerciale e condominiale.
Central gear motor for rolling shutters



08 R-CONTROL

Trasmittitore a radio frequenza (434,15 MHz) capace di attivare tutte le automazioni su 6 canali e gestione di gruppi multipli.
Remote control transmitter (434,15 MHz) can be used to activate all actuator functions over 6 channels and manage multiple groups



09 W-BUS

WBUS GATE è un dispositivo di telecontrollo wireless con web server integrato, basato su rete cellulare dati GSM / GPRS / HSPA e LAN, WLAN che consente il monitoraggio continuo non presidiato di grandezze elettriche di processo ed il comando remoto degli attuatori elettrici WBUS ed altri sistemi elettronici.

WBUS GATE is a wireless remote monitoring device with an integrated web server capable of working over GSM / GPRS / HSPA cellular and LAN / WLAN data networks. The unit provides fully-automated constant monitoring over electrical process parameters as well as the remote control of WBUS electronic actuators and other electronic systems.



03 FAST



Attuatore elettrico a stelo per apertura e chiusura di finestre a sporgere, a lamelle, pale frangisole e cupole
Spindle actuator for opening and closing top-hung outward windows, skylights, solar shading and domes



04 RAYWIN



Attuatore elettrico a stelo per apertura e chiusura di finestre a sporgere, a lamelle, pale frangisole e cupole
Spindle actuator for opening and closing top-hung outward windows, skylights, solar shading and domes



07 SHOWIN



Attuatore elettrico tubolare per apertura e chiusura di tapparelle, tende esterne, tende oscuranti, tende filtranti e zanzariere
Tubular motor for opening and closing roller shutters, sun awnings, blinds, sunscreens and mosquito screens



NEW SHOWIN 3FC



Terzo fine-corsa intermedio programmabile, Radiocomando incluso nella confezione
Third programmable intermediate limit switch, Radio remote control included in the package

Third programmable intermediate limit switch, Radio remote control included in the package



10 ACCESSORIES

Disponibile per tutti gli attuatori una vasta gamma di accessori tra cui i rilevatori di pioggia, vento e sole.
A vast range of accessories is available for all our actuators including rain, wind and sun sensors



TWIN L25 DECOUPLER NEW



SMART ACCESSORIES

ATTACCO PER FINESTRE A SPORGERE FITTING FOR TOP-HUNG WINDOWS

30 pieces per pack (1,10 Kg)

■ Black	ML00AA01NOB00	€ 4,012
■ Grey	ML00AA01NOG00	€ 4,012
□ White	ML00AA01NOW00	€ 4,012
■ Ivory	ML00AA01N1W00	€ 4,471



ATTACCO PER FINESTRE A VASISTAS FITTING FOR BOTTOM-HUNG WINDOWS

20 pieces per pack (1,21 Kg)

■ Black	ML00AA03NOB00	€ 8,598
■ Grey	ML00AA03NOG00	€ 8,598
□ White	ML00AA03NOW00	€ 8,598
■ Ivory	ML00AA03N1W00	€ 9,515



Attuatore elettrico a catena per l'apertura e chiusura di finestre a sporgere, shed, lucernai, vasistas in legno, PVC e alluminio.

Chain actuator for opening and closing top-hung outward windows, shed, skylights and bottom-hung inward windows in wood, PVC and aluminium.

STAFFE DI SUPPORTO SUPPORT BRACKETS

20 pieces per pack (0,97 Kg)

■ Black	ML00AS01NOB00	€ 4,586
■ Grey	ML00AS01NOG00	€ 4,586
□ White	ML00AS01NOW00	€ 4,586
■ Ivory	ML00AS01N1W00	€ 5,044



STAFFE DI SUPPORTO PER ABBAINO SUPPORT BRACKETS FOR DORMER WINDOW

20 pieces per pack (0,76 Kg)

■ Black	ML00AS02NOB00	€ 14,215
■ Grey	ML00AS02NOG00	€ 14,215
□ White	ML00AS02NOW00	€ 14,215



STAFFE DI SUPPORTO VERSIONE ALTA SUPPORT BRACKETS HIGH VERSION

10 pieces per pack (1,94 Kg)

■ Black	ML00AS03NOB00	€ 17,769
■ Grey	ML00AS03NOG00	€ 17,769
□ White	ML00AS03NOW00	€ 17,769



STAFFE DI SUPPORTO VERSIONE BASSA SUPPORT BRACKETS SMALL VERSION

10 pieces per pack (1,42 Kg)

■ Black	ML00AS05NOB00	€ 17,425
■ Grey	ML00AS05NOG00	€ 17,425
□ White	ML00AS05NOW00	€ 17,425



RILEVATORE DI PIOGGIA RAIN SENSOR

1 piece (0,4 Kg)

MX00AR01NOG00
€ 91,711

MX00AR01N0T00
€ 91,711



RILEVATORE VENTO WIND SENSOR

1 piece (0,3 Kg)

MX00AR02NOG00
€ 91,711

MX00AR02N0T00
€ 91,711



RILEVATORE VENTO/SOLE WIND/SUN SENSOR

1 piece (0,3 Kg)

MX00AR02NOG00
€ 91,711



UNITÀ DI CONTROLLO 1 USCITA MOTORE CON O SENZA RICEVENTE INTEGRATA 1 OUTLET MOTOR CONTROL UNIT WITH OR WITHOUT BUILT-IN RECEIVER

(230 Vac) 1 piece (0,2 Kg)

MX00AU02HOW00 € 91,711

Con ricevente / With receiver

MX00AU03HOW00 € 68,783

Senza ricevente / Without receiver



- SOFT START & STOP
 - Rilevamento ostacoli | *Obstacle detection*
 - Fine corsa per assorbimento | *Stroke limit - resistance*
-
- Velocità a vuoto | *Speed at no load* **18 mm/sec**
 - Forza di spinta | *Thrust force* **200 N**
 - Servizio | *Type of service* **S2 - 4 min**
 - Temp min-max **-5°C / +50°C**

IP20

Aperture | Opening



SMART

+	PRODUCT CODE	DESCRIPTION	+	+	C.C.	€
SMART 24V	MSMART20LOB00	■ SMART-24V C=380 NERO RAL9005	1	0,78	8A	€ 64,198
SMART 24V	MSMART20LOG00	■ SMART-24V C=380 GRIGIO RAL7035	1	0,78	8A	€ 64,198
SMART 24V	MSMART20LOW00	□ SMART-24V C=380 BIANCO RAL9010	1	0,78	8A	€ 64,198
SMART 110V	MSMART20IOB00	■ SMART-110V C=380 NERO RAL9005	1	0,78	8A	€ 70,838
SMART 110V	MSMART20IOG00	■ SMART-110V C=380 GRIGIO RAL7035	1	0,78	8A	€ 70,838
SMART 110V	MSMART20IOW00	□ SMART-110V C=380 BIANCO RAL9010	1	0,78	8A	€ 70,838
SMART 230V	MSMART20HOB00	■ SMART-230V C=380 NERO RAL9005	1	0,78	8A	€ 66,491
SMART 230V	MSMART20HOG00	■ SMART-230V C=380 GRIGIO RAL7035	1	0,78	8A	€ 66,491
SMART 230V	MSMART20HOW00	□ SMART-230V C=380 BIANCO RAL9010	1	0,78	8A	€ 66,491



LIWIN ACCESSORIES



ATTACCO PER FINESTRE A SPORGERE FITTING FOR TOP-HUNG WINDOWS

30 pieces per pack (1,10 Kg)

■ Black	ML00AA01NOB00	€ 4,012
■ Grey	ML00AA01NOG00	€ 4,012
□ White	ML00AA01NOW00	€ 4,012
■ Ivory	ML00AA01N1W00	€ 4,471



ATTACCO PER FINESTRE A VASISTAS FITTING FOR BOTTOM-HUNG WINDOWS

20 pieces per pack (1,21 Kg)

■ Black	ML00AA03NOB00	€ 8,598
■ Grey	ML00AA03NOG00	€ 8,598
□ White	ML00AA03NOW00	€ 8,598
■ Ivory	ML00AA03N1W00	€ 9,515



Attuatore elettrico a catena per l'apertura e chiusura di finestre a sporgere, shed, lucernai, vasistas in legno, PVC e alluminio.

Chain actuator for opening and closing top-hung outward windows, shed, skylights and bottom-hung inward windows in wood, PVC and aluminium.

STAFFE E DI SUPPORTO SUPPORT BRACKETS

20 pieces per pack (1,0 Kg)

■ Black	ML00AS01NOB00	€ 4,586
■ Grey	ML00AS01NOG00	€ 4,586
□ White	ML00AS01NOW00	€ 4,586
■ Ivory	ML00AS01N1W00	€ 5,044



STAFFE DI SUPPORTO PER ABBAINO SUPPORT BRACKETS FOR DORMER WINDOW

20 pieces per pack (0,76 Kg)

■ Black	ML00AS02NOB00	€ 14,215
■ Grey	ML00AS02NOG00	€ 14,215
□ White	ML00AS02NOW00	€ 14,215



STAFFE DI SUPPORTO VERSIONE ALTA SUPPORT BRACKETS HIGH VERSION

10 pieces per pack (1,94 Kg)

■ Black	ML00AS03NOB00	€ 17,769
■ Grey	ML00AS03NOG00	€ 17,769
□ White	ML00AS03NOW00	€ 17,769



STAFFE DI SUPPORTO VERSIONE BASSA SUPPORT BRACKETS SMALL VERSION

10 pieces per pack (1,42 Kg)

■ Black	ML00AS05NOB00	€ 17,425
■ Grey	ML00AS05NOG00	€ 17,425
□ White	ML00AS05NOW00	€ 17,425



RILEVATORE DI PIOGGIA RAIN SENSOR

1 piece (0,4 Kg)

MX00AR01NOG00
€ 91,711

MX00AR01N0T00
€ 91,711



RILEVATORE VENTO WIND SENSOR

1 piece (0,3 Kg)

MX00AR02NOG00
€ 91,711

MX00AR02N0T00
€ 91,711



RILEVATORE VENTO/SOLE WIND/SUN SENSOR

1 piece (0,3 Kg)

MX00AR02N0T00
€ 91,711

UNITÀ DI CONTROLLO 1 USCITA MOTORE CON O SENZA RICEVENTE INTEGRATA 1 OUTLET MOTOR CONTROL UNIT WITH OR WITHOUT BUILT-IN RECEIVER

(230 Vac) 1 piece (0,2 Kg)

MX00AU02HOW00 € 91,711
Con ricevente / With receiver

MX00AU03HOW00 € 68,783
Senza ricevente / Without receiver



Aperture | Opening



- IP44**
- SOFT START & STOP
- Rilevamento ostacoli | *Obstacle detection*
- Fine corsa per assorbimento | *Stroke limit - resistance*

- Velocità a vuoto | *Speed at no load* **18 mm/sec**
- Forza di spinta | *Thrust force* **250 N**
- Servizio | *Type of service* **S2 - 4 min**
- Temp min-max **-5°C / +50°C**

LIWIN L25

📄	PRODUCT CODE	DESCRIPTION	📄	🔒	C.C.	€
L25 -110V base	ML25S138I0B00	■ LIWIN 250N SINGOLO 110V NERO RAL9005	1	1,22	8A	€ 88,683
L25 -110V base	ML25S138I0G00	■ LIWIN 250N SINGOLO 110V GRIGIO RAL7035	1	1,22	8A	€ 88,683
L25 -110V base	ML25S138I0W00	□ LIWIN 250N SINGOLO 110V BIANCO RAL9010	1	1,22	8A	€ 88,683
L25 -230V base	ML25S138H0B00	■ LIWIN 250N SINGOLO 230V NERO RAL9005	1	1,22	8A	€ 83,113
L25 -230V base	ML25S138H0G00	■ LIWIN 250N SINGOLO 230V GRIGIO RAL7035	1	1,22	8A	€ 83,113
L25 -230V base	ML25S138H0W00	□ LIWIN 250N SINGOLO 230V BIANCO RAL9010	1	1,22	8A	€ 83,113
L25 -230V base	ML25S138H1W00	■ LIWIN 250N SINGOLO 230V AVORIO RAL1013	1	1,22	8A	€ 91,711



- W**
NET
- Collegamento senza centralina | *Without control unit*
- SOFT START & STOP
- Rilevamento ostacoli | *Obstacle detection*
- Fine corsa per assorbimento | *Stroke limit - resistance*

- IP44**
- Velocità a vuoto | *Speed at no load* **18 mm/sec**
- Forza di spinta | *Thrust force* **350 N**
- Servizio | *Type of service* **S2 - 4 min**
- Temp min-max **-5°C / +50°C**

LIWIN L35

📄	PRODUCT CODE	DESCRIPTION	📄	🔒	C.C.	€
L35 -230V base	ML35S140H0B00	■ LIWIN 350N SINGOLO 230V NERO RAL9005	1	1,23	8A	€ 107,761
L35 -230V base	ML35S140H0G00	■ LIWIN 350N SINGOLO 230V GRIGIO RAL7035	1	1,23	8A	€ 107,761
L35 -230V base	ML35S140H0W00	□ LIWIN 350N SINGOLO 230V BIANCO RAL9010	1	1,23	8A	€ 107,761
L35-230V base	ML35S140H1W00	■ LIWIN 350N SINGOLO 230V AVORIO RAL1013	1	1,23	8A	€ 118,651
L35-24V base	ML35S140L0B00	■ LIWIN 350N SINGOLO 24V NERO RAL9005	1	1,22	8A	€ 89,992
L35-24V base	ML35S140L0G00	■ LIWIN 350N SINGOLO 24V GRIGIO RAL7035	1	1,22	8A	€ 89,992
L35-24V base	ML35S140L0W00	□ LIWIN 350N SINGOLO 24V BIANCO RAL9010	1	1,22	8A	€ 89,992
L35-24V base	ML35S140L1W00	■ LIWIN 350N SINGOLO 24V AVORIO RAL1013	1	1,22	8A	€ 99,163

LIWIN L35 2W-NET

	PRODUCT CODE	DESCRIPTION			C.C.	€
L35-230V 2 W-NET	ML35S240H0B00	■ LIWIN 350N DOPPIO 230V NERO RAL9005	1	2,46	8A	€ 341,624
L35-230V 2 W-NET	ML35S240H0G00	■ LIWIN 350N DOPPIO 230V GRIGIO RAL7035	1	2,46	8A	€ 341,624
L35-230V 2 W-NET	ML35S240H0W00	□ LIWIN 350N DOPPIO 230V BIANCO RAL9010	1	2,46	8A	€ 341,624
L35-24V 2 W-NET	ML35S240L0B00	■ LIWIN 350N DOPPIO 24V NERO RAL9005	1	2,45	8A	€ 286,598
L35-24V 2 W-NET	ML35S240L0G00	■ LIWIN 350N DOPPIO 24V GRIGIO RAL7035	1	2,45	8A	€ 286,598
L35-24V 2 W-NET	ML35S240L0W00	□ LIWIN 350N DOPPIO 24V BIANCO RAL9010	1	2,45	8A	€ 286,598





LIWIN L35 3W-NET

	PRODUCT CODE	DESCRIPTION			C.C.	€
L35-230V 3 W-NET	ML35S340H0B00	■ LIWIN 350N TRIPLO 230V NERO RAL9005	1	3,68	8A	€ 615,611
L35-230V 3 W-NET	ML35S340H0G00	■ LIWIN 350N TRIPLO 230V GRIGIO RAL7035	1	3,68	8A	€ 615,611
L35-230V 3 W-NET	ML35S340H0W00	□ LIWIN 350N TRIPLO 230V BIANCO RAL9010	1	3,68	8A	€ 615,611
L35-24V 3 W-NET	ML35S340L0B00	■ LIWIN 350N TRIPLO 24V NERO RAL9005	1	3,65	8A	€ 521,607
L35-24V 3 W-NET	ML35S340L0G00	■ LIWIN 350N TRIPLO 24V GRIGIO RAL7035	1	3,65	8A	€ 521,607
L35-24V 3 W-NET	ML35S340L0W00	□ LIWIN 350N TRIPLO 24V BIANCO RAL9010	1	3,65	8A	€ 521,607



LIWIN L35 4W-NET

	PRODUCT CODE	DESCRIPTION			C.C.	€
L35-230V 4 W-NET	ML35S440H0B00	■ LIWIN 350N QUADRUPLO 230V NERO RAL9005	1	4,90	8A	€ 819,669
L35-230V 4 W-NET	ML35S440H0G00	■ LIWIN 350N QUADRUPLO 230V GRIGIO RAL7035	1	4,90	8A	€ 819,669
L35-230V 4 W-NET	ML35S440H0W00	□ LIWIN 350N QUADRUPLO 230V BIANCO RAL9010	1	4,90	8A	€ 819,669
L35-24V 4 W-NET	ML35S440L0B00	■ LIWIN 350N QUADRUPLO 24V NERO RAL9005	1	4,87	8A	€ 687,834
L35-24V 4 W-NET	ML35S440L0G00	■ LIWIN 350N QUADRUPLO 24V GRIGIO RAL7035	1	4,87	8A	€ 687,834
L35-24V 4 W-NET	ML35S440L0W00	□ LIWIN 350N QUADRUPLO 24V BIANCO RAL9010	1	4,84	8A	€ 687,834



Aperture | Opening



- W** **NET** ■ Collegamento senza centralina | *Without control unit*
- SOFT START & STOP
- Rilevamento ostacoli | *Obstacle detection*
- IP44** ■ Fine corsa per assorbimento | *Stroke limit - resistance*
- Velocità a vuoto | *Speed at no load* 18 mm/sec
- Forza di spinta | *Thrust force* 350 N
- Servizio | *Type of service* S2 - 4 min
- Temp min-max -5°C / +50°C

LIWIN L35 RADIO

	PRODUCT CODE	DESCRIPTION			C.C.	€
L35 - 230V RADIO	ML35R140H0B00	■ LIWIN 350N SINGOLO 230V RADIO RAL9005	1	1,23	8A	€ 153,616
L35 - 230V RADIO	ML35R140H0G00	■ LIWIN 350N SINGOLO 230V RADIO RAL7035	1	1,23	8A	€ 153,616
L35 - 230V RADIO	ML35R140H0W00	□ LIWIN 350N SINGOLO 230V RADIO RAL9010	1	1,23	8A	€ 153,616

Alimentazione Radiocomando non incluso L < 125 cm Fino a **6** canali
Power supply Remote control not included Base / Length Up to **6** channels

LIWIN L35 RADIO 2W-NET

	PRODUCT CODE	DESCRIPTION			C.C.	€
L35-230V Radio 2 W-NET	ML35R240H0B00	■ LIWIN 350N DOPPIO 230V RADIO RAL9005	1	2,46	8A	€ 382,894
L35-230V Radio 2 W-NET	ML35R240H0G00	■ LIWIN 350N DOPPIO 230V RADIO RAL7035	1	2,46	8A	€ 382,894
L35-230V Radio 2 W-NET	ML35R240H0W00	□ LIWIN 350N DOPPIO 230V RADIO RAL9010	1	2,46	8A	€ 382,894

2W **NET** Alimentazione Radiocomando non incluso L 125 < 250 cm Fino a **6** canali
Power supply Remote control not included Base / Length Up to **6** channels

LIWIN L35 RADIO 3W-NET

	PRODUCT CODE	DESCRIPTION			C.C.	€
L35-230V Radio 3 W-NET	ML35R340H0B00	■ LIWIN 350N TRIPLO 230V RADIO RAL9005	1	3,66	8A	€ 661,467
L35-230V Radio 3 W-NET	ML35R340H0G00	■ LIWIN 350N TRIPLO 230V RADIO RAL7035	1	3,66	8A	€ 661,467
L35-230V Radio 3 W-NET	ML35R340H0W00	□ LIWIN 350N TRIPLO 230V RADIO RAL9010	1	3,66	8A	€ 661,467

3W **NET** Alimentazione Radiocomando non incluso L 250 < 375 cm Fino a **6** canali
Power supply Remote control not included Base / Length Up to **6** channels

LIWIN L35 RADIO 4W-NET

	PRODUCT CODE	DESCRIPTION			C.C.	€
L35-230V Radio 4 W-NET	ML35R440H0B00	■ LIWIN 350N QUADRUPLO 230V RADIO RAL9005	1	4,90	8A	€ 865,524
L35-230V Radio 4 W-NET	ML35R440H0G00	■ LIWIN 350N QUADRUPLO 230V RADIO RAL7035	1	4,90	8A	€ 865,524
L35-230V Radio 4 W-NET	ML35R440H0W00	□ LIWIN 350N QUADRUPLO 230V RADIO RAL9010	1	4,90	8A	€ 865,524

4W **NET** Alimentazione Radiocomando non incluso L 375 < 500 cm Fino a **6** canali
Power supply Remote control not included Base / Length Up to **6** channels

FAST ACCESSORIES

Attuatore elettrico a stelo per apertura e chiusura di finestre a sporgere, a lamelle, pale frangisole e cupole
Spindle actuator for opening and closing top-hung outward windows, skylights, solar shading and domes.



STAFFE DI SUPPORTO / SUPPORT BRACKETS

10 pieces x pack (0,2 Kg)

MFASTS01NOG00 € 21,781
Zincato bianco / White galvanized



ATTACCO PER FINESTRE / FITTING FOR WINDOWS

30 pieces x pack (0,1 Kg)

MR00AA01NOG00 € 7,452
Zincato bianco / White galvanized



RILEVATORE DI PIOGGIA RAIN SENSOR

1 piece (0,4 Kg)

MX00AR01NOG00
€ 91,711

MX00AR01NOT00
€ 91,711



RILEVATORE VENTO WIND SENSOR

1 piece (0,3 Kg)

MX00AR02NOG00
€ 91,711



RILEVATORE VENTO/SOLE WIND/SUN SENSOR

1 piece (0,3 Kg)

MX00AR02NOT00
€ 91,711

UNITÀ DI CONTROLLO 1 USCITA MOTORE CON O SENZA RICEVENTE INTEGRATA 1 OUTLET MOTOR CONTROL UNIT WITH OR WITHOUT BUILT-IN RECEIVER

(230 Vac) 1 piece (0,2 Kg)

MX00AU02HOW00 € 91,711
Con ricevente / With receiver

MX00AU03HOW00 € 68,783
Senza ricevente / Without receiver



- SOFT START & STOP
- Rilevamento ostacoli | *Obstacle detection*
- Fine corsa | *Stroke limit*

IP55

- Velocità a vuoto | *Speed at no load* **19 mm/sec**
- Forza di spinta | *Thrust force* **500 N**
- Servizio | *Type of service* **S2 - 4 min**
- Temp min-max **-5°C / +50°C**

Aperture | Opening

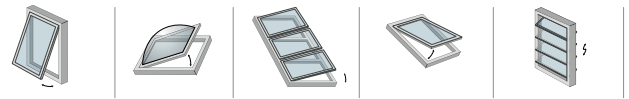

FAST

+	PRODUCT CODE	DESCRIPTION	+	+	C.C.	€
FAST-160	MFAST160H0B00	■ FAST50/160-230V NERO RAL9005	1	1,65	8B	€ 105,468
FAST-200	MFAST200H0B00	■ FAST50/200-230V NERO RAL9005	1	1,68	8B	€ 105,468
FAST-300	MFAST300H0B00	■ FAST50/300-230V NERO RAL9005	1	1,70	8B	€ 109,480
FAST-400	MFAST400H0B00	■ FAST50/400-230V NERO RAL9005	1	1,75	8B	€ 126,103



RAYWIN ACCESSORIES



Attuatore elettrico a stelo per apertura e chiusura di finestre a sporgere, a lamelle, pale frangisole e cupole

Spindle actuator for opening and closing top-hung outward windows, skylights, solar shading and domes

STAFFE DI SUPPORTO / SUPPORT BRACKETS

10 pieces x pack (1,5 Kg)

MR00AS01NOG00 € 21,781
Zincato bianco / White galvanized



ATTACCO PER FINESTRE / FITTING FOR WINDOWS

30 pieces x pack (2,0 Kg)

MR00AA01NOG00 € 7,452
Zincato bianco / White galvanized



RILEVATORE DI PIOGGIA RAIN SENSOR

1 piece (0,4 Kg)

MX00AR01NOG00
€ 91,711

MX00AR01NOT00
€ 91,711



RILEVATORE VENTO WIND SENSOR

1 piece (0,3 Kg)

MX00AR02NOG00
€ 91,711

RILEVATORE VENTO/SOLE WIND/SUN SENSOR

1 piece (0,3 Kg)

MX00AR02NOT00
€ 91,711



UNITÀ DI CONTROLLO 1 USCITA MOTORE CON O SENZA RICEVENTE INTEGRATA 1 OUTLET MOTOR CONTROL UNIT WITH OR WITHOUT BUILT-IN RECEIVER

(230 Vac) 1 piece (0,2 Kg)

MX00AU02H0W00 € 91,711
Con ricevente / With receiver

MX00AU03H0W00 € 68,783
Senza ricevente / Without receiver



Aperture | Opening

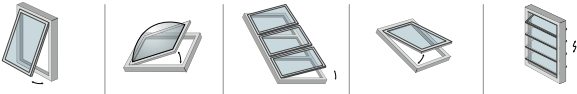

- IP44**
- SOFT START & STOP
 - Rilevamento ostacoli | *Obstacle detection*
 - Fine corsa per assorbimento | *Stroke limit - resistance*
- Velocità a vuoto | *Speed at no load* 12 mm/sec
 - Forza di spinta | *Thrust force* 200 N
 - Servizio | *Type of service* S2 - 4 min
 - Temp min-max -5°C / +50°C

RAYWIN R20

	PRODUCT CODE	DESCRIPTION			C.C.	€
R20/300 - 230V base	MR20S130HOG00	■ RAYWIN 200N C=300 SINGOLO 230V RAL7035	1	1,90	8B	€ 150,177
R20/300 - 24V base	MR20S130LOG00	■ RAYWIN 200N C=300 SINGOLO 24V RAL7035	1	1,90	8B	€ 142,152



- IP44**
- SOFT START & STOP
 - Rilevamento ostacoli | *Obstacle detection*
 - Fine corsa per assorbimento | *Stroke limit - resistance*
- Velocità a vuoto | *Speed at no load* 12 mm/sec
 - Forza di spinta | *Thrust force* 450 N
 - Servizio | *Type of service* S2 - 4 min
 - Temp min-max -5°C / +50°C

RAYWIN R45

	PRODUCT CODE	DESCRIPTION			C.C.	€
R45/200 - 230V base	MR45S120HOG00	■ RAYWIN 450N C=200 SINGOLO 230V RAL7035	1	1,90	8B	€ 152,470
R45/200 - 24V base	MR45S120LOG00	■ RAYWIN 450N C=200 SINGOLO 24V RAL7035	1	1,90	8B	€ 144,445
R45/300 - 230V base	MR45S130HOG00	■ RAYWIN 450N C=300 SINGOLO 230V RAL7035	1	1,90	8B	€ 152,470
R45/300 - 24V base	MR45S130LOG00	■ RAYWIN 450N C=300 SINGOLO 24V RAL7035	1	1,90	8B	€ 144,445
R45/400 - 230V base	MR45S140HOG00	■ RAYWIN 450N C=400 SINGOLO 230V RAL7035	1	2,30	8B	€ 155,909
R45/400 - 24V base	MR45S140LOG00	■ RAYWIN 450N C=400 SINGOLO 24V RAL7035	1	2,30	8B	€ 147,884



- Collegamento senza centralina | *Without control unit*
- SOFT START & STOP



- Rilevamento ostacoli | *Obstacle detection*
- Fine corsa per assorbimento | *Stroke limit - resistance*

- Velocità a vuoto | *Speed at no load* 12 mm/sec
- Forza di spinta | *Thrust force* 600 N
- Servizio | *Type of service* S2 - 4 min
- Temp min-max -5°C / +50°C

RAYWIN R60

	PRODUCT CODE	DESCRIPTION			C.C.	€
R60/300 - 230V base	MR60S130H0G00	■ RAYWIN 600N C=300 SINGOLO 230V RAL7035	1	1,90	8B	€ 182,276
R60/300 - 24V base	MR60S130L0G00	■ RAYWIN 600N C=300 SINGOLO 24V RAL7035	1	1,90	8B	€ 154,763
R60/500 - 230V base	MR60S150H0G00	■ RAYWIN 600N C=500 SINGOLO 230V RAL7035	1	2,30	8B	€ 186,862
R60/500 - 24V base	MR60S150L0G00	■ RAYWIN 600N C=500 SINGOLO 24V RAL7035	1	2,30	8B	€ 158,202

RAYWIN R60 2W-NET

	PRODUCT CODE	DESCRIPTION			C.C.	€
R60/300 - 230V 2 W-NET	MR60S230H0G00	■ RAYWIN 600N C=300 DOPPIO 230V RAL7035	1	3,80	8B	€ 513,583
R60/300 - 24V 2 W-NET	MR60S230L0G00	■ RAYWIN 600N C=300 DOPPIO 24V RAL7035	1	3,80	8B	€ 453,970
R60/500 - 230V 2 W-NET	MR60S250H0G00	■ RAYWIN 600N C=500 DOPPIO 230V RAL7035	1	4,60	8B	€ 522,754
R60/500 - 24V 2 W-NET	MR60S250L0G00	■ RAYWIN 600N C=500 DOPPIO 24V RAL7035	1	4,60	8B	€ 470,020



RAYWIN R60 3W-NET

	PRODUCT CODE	DESCRIPTION			C.C.	€
R60/300 - 230V 3 W-NET	MR60S330H0G00	■ RAYWIN 600N C=300 TRIPLO 230V RAL7035	1	5,70	8B	€ 873,549
R60/300 - 24V 3 W-NET	MR60S330L0G00	■ RAYWIN 600N C=300 TRIPLO 24V RAL7035	1	5,70	8B	€ 770,374
R60/500 - 230V 3 W-NET	MR60S350H0G00	■ RAYWIN 600N C=500 TRIPLO 230V RAL7035	1	6,90	8B	€ 888,452
R60/500 - 24V 3 W-NET	MR60S350L0G00	■ RAYWIN 600N C=500 TRIPLO 24V RAL7035	1	6,90	8B	€ 785,277



RAYWIN R60 4W-NET

	PRODUCT CODE	DESCRIPTION			C.C.	€
R60/300 - 230V 4 W-NET	MR60S430H0G00	■ RAYWIN 600N C=300 QUADRUPLO 230V RAL7035	1	7,60	8B	€ 1.163,586
R60/300 - 24V 4 W-NET	MR60S430L0G00	■ RAYWIN 600N C=300 QUADRUPLO 24V RAL7035	1	7,60	8B	€ 1.027,165
R60/500 - 230V 4 W-NET	MR60S450H0G00	■ RAYWIN 600N C=500 QUADRUPLO 230V RAL7035	1	9,20	8B	€ 1.186,514
R60/500 - 24V 4 W-NET	MR60S450L0G00	■ RAYWIN 600N C=500 QUADRUPLO 24V RAL7035	1	9,20	8B	€ 1.054,679





IP44

- Collegamento senza centralina | *Without control unit*
- SOFT START & STOP
- Rilevamento ostacoli | *Obstacle detection*
- Fine corsa per assorbimento | *Stroke limit - resistance*

- Velocità a vuoto | *Speed at no load* 12 mm/sec
- Forza di spinta | *Thrust force* 600 N
- Servizio | *Type of service* S2 - 4 min
- Temp min-max -5°C / +50°C

RAYWIN R60 REGULATOR

	PRODUCT CODE	DESCRIPTION			C.C.	€
R60/O-300R 230V base	MR60S103H0G00	■ RAYWIN 600N C=300 REGULATOR 230V RAL 7035	1	1,90	8B	€ 218,960
R60/O-300R 24V base	MR60S103L0G00	■ RAYWIN 600N C=300 REGULATOR 24V RAL 7035	1	1,90	8B	€ 185,715
R60/O-500R 230V base	MR60S105H0G00	■ RAYWIN 600N C=500 REGULATOR 230V RAL 7035	1	2,30	8B	€ 224,692
R60/O-500R 24V base	MR60S105L0G00	■ RAYWIN 600N C=500 REGULATOR 24V RAL 7035	1	2,30	8B	€ 190,301



AIRWIN ACCESSORIES

Attuatore elettrico a cremagliera per apertura e chiusura di Shed, lucernai, pale frangisole e cupole

Rack actuator for opening/closing SHED top-hung windows, skylights, brise soleil blades and domes



01 STAFFE DI SUPPORTO / SUPPORT BRACKETS

10 pieces x pack (2,0 Kg)

MR00AS01NOG00 € 21,781

Zincato bianco / White galvanized

02 ATTACCO PER FINESTRE / FITTING FOR WINDOWS

30 pieces x pack (2,1 Kg)

MR00AA01NOG00 € 7,452

Zincato bianco / White galvanized

04 BOCCOLE / COLLARS

10 coppie x pack (1,5 Kg)

MA00XX02NOG00 € 7,222

Zincato bianco / White galvanized

03 BARRA DI COLLEGAMENTO / CONNECTION BAR

MA00AB01NOG00 L= 895 mm per interasse 1000 mm. Zincato bianco
10 pcs x pack (6,0 Kg)
€ 18,342
for 1000 mm centre distance. White galvanized

MA00AB02NOG00 L= 1395 mm per interasse 1500 mm. Zincato bianco
10 pcs x pack (10,0 Kg)
€ 24,074
for 1500 mm centre distance. White galvanized

MA00AB03NOG00 L= 1895 mm per interasse 2000 mm. Zincato bianco
10 pcs x pack (13,0 Kg)
€ 28,660
for 2000 mm centre distance. White galvanized

MA00AB04NOG00 L= 2395 mm per interasse 2500 mm. Zincato bianco
10 pcs x pack (17,0 Kg)
€ 34,392
for 2500 mm centre distance. White galvanized

MA00AB05NOG00 L= 2985 mm per interasse 3000 mm. Zincato bianco
10 pcs x pack (20,0 Kg)
€ 38,977
for 3000 mm centre distance. White galvanized

RILEVATORE DI PIOGGIA RAIN SENSOR

1 piece (0,4 Kg)

MX00AR01NOG00 € 91,711

MX00AR01N0T00 € 91,711

RILEVATORE VENTO WIND SENSOR

1 piece (0,3 Kg)

MX00AR02NOG00 € 91,711

RILEVATORE VENTO/SOLE WIND/SUN SENSOR

1 piece (0,3 Kg)

MX00AR02N0T00 € 91,711

UNITÀ DI CONTROLLO 1 USCITA MOTORE CON O SENZA RICEVENTE INTEGRATA 1 OUTLET MOTOR CONTROL UNIT WITH OR WITHOUT BUILT-IN RECEIVER

(230 Vac) 1 piece (0,2 Kg)

MX00AU02HOW00 € 91,711

Con ricevente / With receiver

MX00AU03HOW00 € 68,783

Senza ricevente / Without receiver



Aperture | Opening

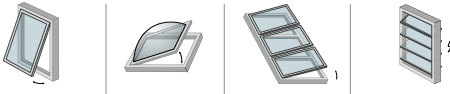

IP44

- SOFT START & STOP
- Rilevamento ostacoli | *Obstacle detection*
- Fine corsa per assorbimento | *Stroke limit - resistance*
- Velocità a vuoto | *Speed at no load* 10 mm/sec
- Forza di spinta | *Thrust force* 450 N
- Servizio | *Type of service* S2 - 4 min
- Temp min-max -5°C / +50°C

AIRWIN A45

📏	PRODUCT CODE	DESCRIPTION	📦	📏	C.C.	€
A45/180-230V base	MA45S118HOG00	■ AIRWIN 450N C=180 SINGOLO 230V RAL7035	1	1,70	8C	€ 118,078
A45/180-24V base	MA45S118LOG00	■ AIRWIN 450N C=180 SINGOLO 24V RAL7035	1	1,70	8C	€ 108,907
A45/230-230V base	MA45S123HOG00	■ AIRWIN 450N C=230 SINGOLO 230V RAL7035	1	1,75	8C	€ 120,371
A45/230-24V base	MA45S123LOG00	■ AIRWIN 450N C=230 SINGOLO 24V RAL7035	1	1,75	8C	€ 111,200
A45/350-230V base	MA45S135HOG00	■ AIRWIN 450N C=350 SINGOLO 230V RAL7035	1	1,90	8C	€ 122,664
A45/350-24V base	MA45S135LOG00	■ AIRWIN 450N C=350 SINGOLO 24V RAL7035	1	1,90	8C	€ 113,493
A45/550-230V base	MA45S155HOG00	■ AIRWIN 450N C=550 SINGOLO 230V RAL7035	1	2,25	8C	€ 131,835
A45/550-24V base	MA45S155LOG00	■ AIRWIN 450N C=550 SINGOLO 24V RAL7035	1	2,25	8C	€ 122,664
A45/750-230V base	MA45S175HOG00	■ AIRWIN 450N C=750 SINGOLO 230V RAL7035	1	2,75	8C	€ 145,592
A45/750-24V base	MA45S175LOG00	■ AIRWIN 450N C=750 SINGOLO 24V RAL7035	1	2,75	8C	€ 132,981
A45/1000-230V base	MA45S10AHOG00	■ AIRWIN 450N C=1000 SINGOLO 230V RAL7035	1	3,00	8C	€ 162,787
A45/1000-24V base	MA45S10ALOG00	■ AIRWIN 450N C=1000 SINGOLO 24V RAL7035	1	3,00	8C	€ 145,592

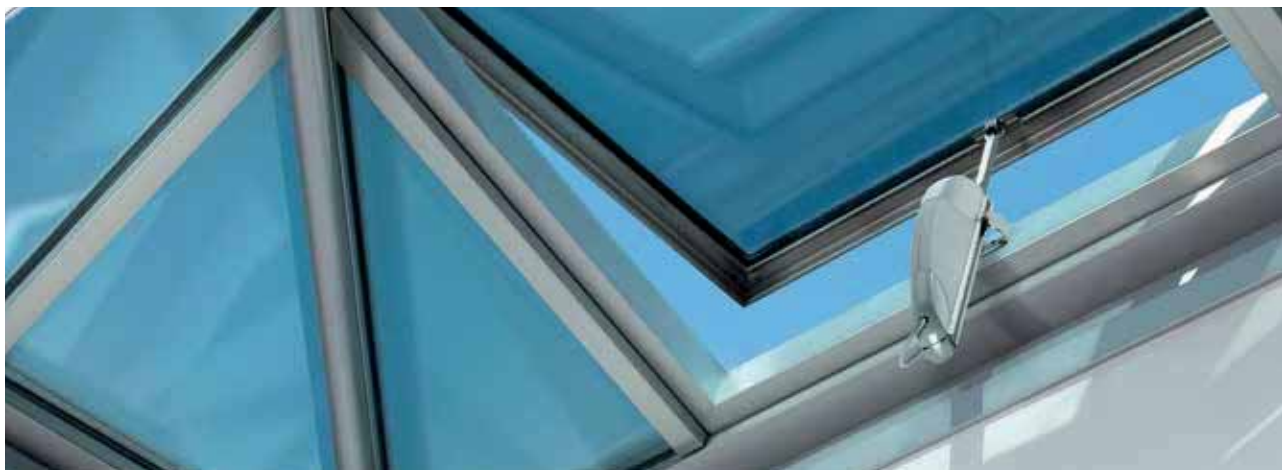

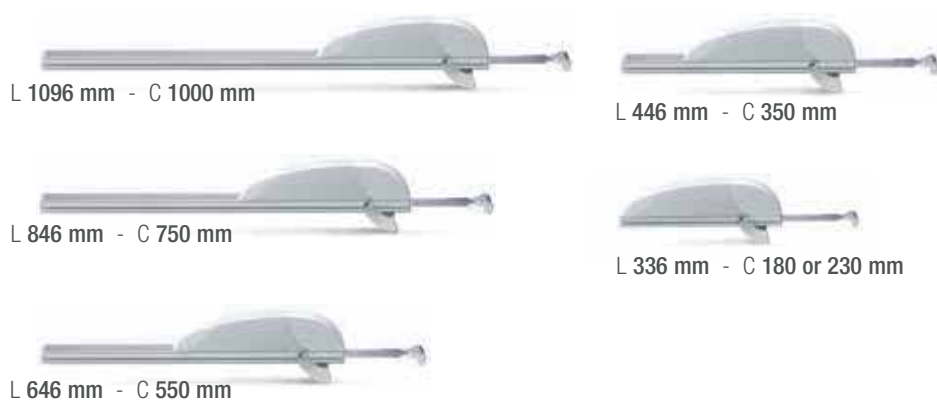

- Collegamento senza centralina | *Without control unit*
 - SOFT START & STOP
 - Rilevamento ostacoli | *Obstacle detection*
 - Fine corsa per assorbimento | *Stroke limit - resistance*
-
- Velocità a vuoto | *Speed at no load* 10 mm/sec
 - Forza di spinta | *Thrust force* 650 N
 - Servizio | *Type of service* S2 - 4 min
 - Temp min-max -5°C / +50°C

AIRWIN A65

	PRODUCT CODE	DESCRIPTION			C.C.	€
A65/180-230V base	MA65S118HOG00	■ AIRWIN 650N C=180 SINGOLO 230V RAL7035	1	1,70	8C	€ 159,348
A65/180-24V base	MA65S118LOG00	■ AIRWIN 650N C=180 SINGOLO 24V RAL7035	1	1,70	8C	€ 131,835
A65/230-230V base	MA65S123HOG00	■ AIRWIN 650N C=230 SINGOLO 230V RAL7035	1	1,75	8C	€ 160,495
A65/230-24V base	MA65S123LOG00	■ AIRWIN 650N C=230 SINGOLO 24V RAL7035	1	1,75	8C	€ 132,981
A65/350-230V base	MA65S135HOG00	■ AIRWIN 650N C=350 SINGOLO 230V RAL7035	1	1,90	8C	€ 163,934
A65/350-24V base	MA65S135LOG00	■ AIRWIN 650N C=350 SINGOLO 24V RAL7035	1	1,90	8C	€ 136,420
A65/550-230V base	MA65S155HOG00	■ AIRWIN 650N C=550 SINGOLO 230V RAL7035	1	2,25	8C	€ 171,959
A65/550-24V base	MA65S155LOG00	■ AIRWIN 650N C=550 SINGOLO 24V RAL7035	1	2,25	8C	€ 145,592
A65/750-230V base	MA65S175HOG00	■ AIRWIN 650N C=750 SINGOLO 230V RAL7035	1	2,75	8C	€ 182,276
A65/750-24V base	MA65S175LOG00	■ AIRWIN 650N C=750 SINGOLO 24V RAL7035	1	2,75	8C	€ 155,909
A65/1000-230V base	MA65S10AHOG00	■ AIRWIN 650N C=1000 SINGOLO 230V RAL7035	1	3,00	8C	€ 207,497
A65/1000-24V base	MA65S10ALOG00	■ AIRWIN 650N C=1000 SINGOLO 24V RAL7035	1	3,00	8C	€ 179,983

AIRWIN A65 2W-NET

	PRODUCT CODE	DESCRIPTION			C.C.	€
A65/180 - 230V 2 W-NET	MA65S218HOG00	■ AIRWIN 650N C=180 DOPPIO 230V RAL7035	1	3,40	8C	€ 450,531
A65/180 - 24V 2 W-NET	MA65S218LOG00	■ AIRWIN 650N C=180 DOPPIO 24V RAL7035	1	3,40	8C	€ 392,065
A65/230 - 230V 2 W-NET	MA65S223HOG00	■ AIRWIN 650N C=230 DOPPIO 230V RAL7035	1	3,50	8C	€ 452,824
A65/230 - 24V 2 W-NET	MA65S223LOG00	■ AIRWIN 650N C=230 DOPPIO 24V RAL7035	1	3,50	8C	€ 394,358
A65/350 - 230V 2 W-NET	MA65S235HOG00	■ AIRWIN 650N C=350 DOPPIO 230V RAL7035	1	3,80	8C	€ 458,556
A65/350 - 24V 2 W-NET	MA65S235LOG00	■ AIRWIN 650N C=350 DOPPIO 24V RAL7035	1	3,80	8C	€ 400,090
A65/550 - 230V 2 W-NET	MA65S255HOG00	■ AIRWIN 650N C=550 DOPPIO 230V RAL7035	1	4,50	8C	€ 478,045
A65/550 - 24V 2 W-NET	MA65S255LOG00	■ AIRWIN 650N C=550 DOPPIO 24V RAL7035	1	4,50	8C	€ 419,579
A65/750 - 230V 2 W-NET	MA65S275HOG00	■ AIRWIN 650N C=750 DOPPIO 230V RAL7035	1	5,50	8C	€ 498,680
A65/750 - 24V 2 W-NET	MA65S275LOG00	■ AIRWIN 650N C=750 DOPPIO 24V RAL7035	1	5,50	8C	€ 440,214
A65/1000 - 230V 2 W-NET	MA65S20AHOG00	■ AIRWIN 650N C=1000 DOPPIO 230V RAL7035	1	6,00	8C	€ 546,828
A65/1000 - 24V 2 W-NET	MA65S20ALOG00	■ AIRWIN 650N C=1000 DOPPIO 24V RAL7035	1	6,00	8C	€ 487,216



AIRWIN A65 3W-NET

	PRODUCT CODE	DESCRIPTION			C.C.	€
A65/180 - 230V 3 W-NET	MA65S318H0G00	AIRWIN 650N C=180 TRIPLO 230V RAL7035	1	5,10	8C	€ 765,789
A65/180 - 24V 3 W-NET	MA65S318L0G00	AIRWIN 650N C=180 TRIPLO 24V RAL7035	1	5,10	8C	€ 666,053
A65/230 - 230V 3 W-NET	MA65S323H0G00	AIRWIN 650N C=230 TRIPLO 230V RAL7035	1	5,25	8C	€ 769,228
A65/230 - 24V 3 W-NET	MA65S323L0G00	AIRWIN 650N C=230 TRIPLO 24V RAL7035	1	5,25	8C	€ 669,492
A65/350 - 230V 3 W-NET	MA65S335H0G00	AIRWIN 650N C=350 TRIPLO 230V RAL7035	1	5,70	8C	€ 779,545
A65/350 - 24V 3 W-NET	MA65S335L0G00	AIRWIN 650N C=350 TRIPLO 24V RAL7035	1	5,70	8C	€ 679,809
A65/550 - 230V 3 W-NET	MA65S355H0G00	AIRWIN 650N C=550 TRIPLO 230V RAL7035	1	6,75	8C	€ 813,937
A65/550 - 24V 3 W-NET	MA65S355L0G00	AIRWIN 650N C=550 TRIPLO 24V RAL7035	1	6,75	8C	€ 713,055
A65/750 - 230V 3 W-NET	MA65S375H0G00	AIRWIN 650N C=750 TRIPLO 230V RAL7035	1	8,25	8C	€ 844,889
A65/750 - 24V 3 W-NET	MA65S375L0G00	AIRWIN 650N C=750 TRIPLO 24V RAL7035	1	8,25	8C	€ 749,739
A65/1000 - 230V 3 W-NET	MA65S30AH0G00	AIRWIN 650N C=1000 TRIPLO 230V RAL7035	1	9,00	8C	€ 928,576
A65/1000 - 24V 3 W-NET	MA65S30AL0G00	AIRWIN 650N C=1000 TRIPLO 24V RAL7035	1	9,00	8C	€ 828,840



AIRWIN A65 4W-NET

	PRODUCT CODE	DESCRIPTION			C.C.	€
A65/180 - 230V 4 W-NET	MA65S418H0G00	AIRWIN 650N C=180 QUADRUPLIO 230V RAL7035	1	6,80	8C	€ 1.020,287
A65/180 - 24V 4 W-NET	MA65S418L0G00	AIRWIN 650N C=180 QUADRUPLIO 24V RAL7035	1	6,80	8C	€ 887,306
A65/230 - 230V 4 W-NET	MA65S423H0G00	AIRWIN 650N C=230 QUADRUPLIO 230V RAL7035	1	7,00	8C	€ 1.026,019
A65/230 - 24V 4 W-NET	MA65S423L0G00	AIRWIN 650N C=230 QUADRUPLIO 24V RAL7035	1	7,00	8C	€ 891,891
A65/350 - 230V 4 W-NET	MA65S435H0G00	AIRWIN 650N C=350 QUADRUPLIO 230V RAL7035	1	7,60	8C	€ 1.039,776
A65/350 - 24V 4 W-NET	MA65S435L0G00	AIRWIN 650N C=350 QUADRUPLIO 24V RAL7035	1	7,60	8C	€ 906,794
A65/550 - 230V 4 W-NET	MA65S455H0G00	AIRWIN 650N C=550 QUADRUPLIO 230V RAL7035	1	9,00	8C	€ 1.083,339
A65/550 - 24V 4 W-NET	MA65S455L0G00	AIRWIN 650N C=550 QUADRUPLIO 24V RAL7035	1	9,00	8C	€ 949,211
A65/750 - 230V 4 W-NET	MA65S475H0G00	AIRWIN 650N C=750 QUADRUPLIO 230V RAL7035	1	11,00	8C	€ 1.129,194
A65/750 - 24V 4 W-NET	MA65S475L0G00	AIRWIN 650N C=750 QUADRUPLIO 24V RAL7035	1	11,00	8C	€ 996,213
A65/1000 - 230V 4 W-NET	MA65S40AH0G00	AIRWIN 650N C=1000 QUADRUPLIO 230V RAL7035	1	12,00	8C	€ 1.238,101
A65/1000 - 24V 4 W-NET	MA65S40AL0G00	AIRWIN 650N C=1000 QUADRUPLIO 24V RAL7035	1	12,00	8C	€ 1.106,266



L 1096 mm - C 1000 mm



L 446 mm - C 350 mm



L 846 mm - C 750 mm



L 336 mm - C 180 or 230 mm



L 646 mm - C 550 mm

IP44

■ Temp min-max

-5°C / +50°C

AIRWIN A MECH

	PRODUCT CODE	DESCRIPTION			C.C.	€
A180 MECH	MA00MC18NOG00	AIRWIN SOLO MECC. C=180 GRIGIO RAL7035	2	1,80	8C	€ 48,148
A230 MECH	MA00MC23NOG00	AIRWIN SOLO MECC. C=230 GRIGIO RAL7035	2	2,00	8C	€ 48,722
A350 MECH	MA00MC35NOG00	AIRWIN SOLO MECC. C=350 GRIGIO RAL7035	2	2,40	8C	€ 52,161
A550 MECH	MA00MC55NOG00	AIRWIN SOLO MECC. C=550 GRIGIO RAL7035	2	3,10	8C	€ 60,759
A750 MECH	MA00MC75NOG00	AIRWIN SOLO MECC. C=750 GRIGIO RAL7035	2	3,80	8C	€ 71,076
A1000 MECH	MA00MCOANO000	AIRWIN SOLO MECC. C=1000 GRIGIO RAL7035	2	4,60	8C	€ 92,858

NEW

SPIN



Motoriduttore per serrande avvolgibili ad uso commerciale e condominiale.
Central gear motor for rolling shutters for commercial and condominium use.

- IP20
 - Albero | Shaft
 - Corona | Pulley
 - Servizio | Type of service
 - Temp min-max
- Ø 48 / 60 mm
 200 / 220 mm
 S2 - 4 min
 -20°C / +85°C

Aperture | Opening



SPIN 140 / 180



📄	PRODUCT CODE	DESCRIPTION	📦	⚖️	C.C.	€
SPIN140	MSPIN140H0B00	MOTORIDUTTORE PER SERRANDE 230V 140NM	1 pcs	7,5 kg	8X	138,000
SPIN180	MSPIN180H0B00	MOTORIDUTTORE PER SERRANDE 230V 180NM	1 pcs	8,5 kg	8X	147,000

SPIN 140 / 180 con elettrofreno | with electrobrake



📄	PRODUCT CODE	DESCRIPTION	📦	⚖️	C.C.	€
SPIN140E	MSPIN14EH0B00	MOTORIDUTTORE PER SERRANDE 230V 140NM EF	1 pcs	8,5 kg	8X	159,000
SPIN180E	MSPIN18EH0B00	MOTORIDUTTORE PER SERRANDE 230V 180NM EF	1 pcs	9,5 kg	8X	170,000

Elettronica di comando | Control accessories



Centrale elettronica 230V con ricevente radio incorporata.

230V electronic control unit with built-in radio receiver.

AF 940 HP

AF 940 BASIC

📄	PRODUCT CODE	DESCRIPTION	📦	⚖️	C.C.	€
AF 940 HP	MP00X001H0000	SCHEDA ELETTRONICA HP	1 pcs	0,52 kg	8X	103,000
AF 940 BASIC	MP00X002H0000	SCHEDA ELETTRONICA BASIC	1 pcs	0,2 kg	8X	85,000

SPIN
ACCESSORIES



AF 900

1 pieces per pack (1,02 Kg)
C.C. 8X
MP00E001H0000 € 21,500
Elettrofreno universale per spin
Electrobrake



AF990

1 pieces per pack (0,4 Kg)
C.C. 8X
MP00E002H0000 € 13,000
Cavo elettrico 4x1 mm2 l=4m
Electric cable 4x1 mm2 l = 4m



AF 540

1 pcs 0,067 kg
C.C. 8X
MP00M00100B00 € 2,800
Manicotto adattatore ø=48 mm
Adaptor for shaft ø=48 mm



AF 545

1 pieces per pack (0,067 kg)
C.C. 8X
MP00M00200B00 € 2,800
Adattatore per corona 220 mm
Adaptor per pulley 220 mm



AF 550

1 pieces per pack (0,58 Kg)
C.C. 8X
MP00M003H0000 € 50,000
Blindino con pulsanti di comando
External release brake armour with pushbutton



DART-SLIM-SYNC

1 pieces per pack (0,12 Kg)
C.C. 8Z
GDARTSLMN0B00 € 78,000
Fotocellula Rx+Tx Sync Nera
Photocell Rx+Tx Sync, black



INDEX-EU

1 pieces per pack (0,45 kg)
C.C. 8Z
GINDEXEUN0B00 € 70,000
Selettore a chiave eu
Euro key-operated switch



TACT

1 pieces per pack (0,39 kg)
C.C. 8Z
GTACTSTDN0B00 € 80,000
Selettore digitale
Digital switch with keypad



TACT-DEC

1 pieces per pack (0,08 Kg)
C.C. 8Z
GTACTDECN0B00 € 60,000
Decoder per tastierino
Decoder



AC-30

1 pieces per pack (0,12 Kg)
C.C. 8Z
GANTENNANOG00 € 29,000
Antenna esterna nera
Outdoor antenna



RECEIVER

1 pieces per pack (0,2 kg)
C.C. 8Z
GRESIVERNOG00 € 80,000
Ricevitore radio
Radio receiver



VICTOR-2RC

1 pieces per pack (0,02 kg)
C.C. 8U
GVCTR2STNOV00 Verde
GVCTR2STNOL00 Blu
GVCTR2STNOY00 Giallo
GVCTR2STNOR00 Rosso
GVCTR2STNOG00 Ardesia
Radiocomando 2 canali rolling code
2 channel radio command Rolling Code



€ 34,000

VICTOR-4RC

1 pieces per pack (0,02 kg)
C.C. 8U
GVCTR4STNOV00 Verde
GVCTR4STNOL00 Blu
GVCTR4STNOY00 Giallo
GVCTR4STNOR00 Rosso
GVCTR4STNOG00 Ardesia
Radiocomando 4 canali rolling code
4 channel radio command Rolling Code



€ 39,000

SHOWIN ACCESSORIES

Attuatore elettrico tubolare per
l'apertura e la chiusura di
tapparelle,
tende esterne, tende oscuranti,
tende filtranti e zanzariere

*Tubular motor for opening/closing roller
shutters, sun awnings, blinds,
sunscreens and mosquito screens*



Accessori disponibili per
tutti i modelli Showin

*Accessories available for
all Showin models*

OCCHIOLO ESAGONO / EYELET

10 pieces per pack (0,6 Kg)

MS00XX01N0G00 € 6,305

Occhiolo esagono 7 x 80 mm con manovra di soccorso
Eyelet with 7 x 80 mm hexagon with manual override



OCCHIOLO SNODO 45° / 45° JOINT EYELET

10 pieces per pack (3,4 Kg)

MS00XX02N0G00 € 35,538

Occhiolo snodo 45° con manovra di soccorso
45° joint eyelet with manual override



OCCHIOLO SNODO 90° / 90° JOINT EYELET

10 pieces per pack (3,6 Kg)

MS00XX03N0G00 € 58,466

Occhiolo snodo 90° con manovra di soccorso
90° joint eyelet with manual override



ASTA MANUALE FISSA CON GANCIO / FIXED MANUAL CRANK WITH HOOK

MS00XX04N0G00 L= 1500mm con manovra di soccorso / with manual override
1 pieces per pack (0,7 Kg) € 25,221

MS00XX05N0G00 L= 1800mm con manovra di soccorso / with manual override
1 pieces per pack (0,8 Kg) € 25,794



ASTA MANUALE ARTICOLATA CON GANCIO / FOLDABLE MANUAL CRANK WITH HOOK

MS00XX06N0G00 L= 1800mm con manovra di soccorso / with manual override
1 pieces per pack (0,7 Kg) € 26,940



RILEVATORE DI PIOGGIA RAIN SENSOR

1 piece (0,4 Kg)

MX00AR01N0G00
€ 91,711

MX00AR01N0T00
€ 91,711



RILEVATORE VENTO WIND SENSOR

1 piece (0,3 Kg)

MX00AR02N0G00
€ 91,711



RILEVATORE VENTO/SOLE WIND/SUN SENSOR

1 piece (0,3 Kg)

MX00AR02N0T00
€ 91,711



UNITÀ DI CONTROLLO 1 USCITA MOTORE CON O SENZA RICEVENTE INTEGRATA 1 OUTLET MOTOR CONTROL UNIT WITH OR WITHOUT BUILT-IN RECEIVER

(230 Vac) 1 piece (0,2 Kg)

MX00AU02H0W00 € 91,711
Con ricevente / With receiver

MX00AU03H0W00 € 68,783
Senza ricevente / Without receiver



Aperture | Opening



- Rilevamento ostacoli | *Obstacle detection*
- Servizio | *Type of service* S2 - 4 min
- Temp min-max -5°C / +50°C

IP44

SHOWIN S35 Ø35mm

	PRODUCT CODE	DESCRIPTION			C.C.	€
S35 6N	MS35SM06H0B00	SHOWIN MOTORIDUTTORE Ø35 6NM	1	1,40	8D	€ 112,919
S35 10N	MS35SM10H0B00	SHOWIN MOTORIDUTTORE Ø35 10NM	1	1,40	8D	€ 120,371

SHOWIN S35 Accessories

PULEGGIA / ADAPTER

1 pieces per pack (0,3 Kg)

MS35AP01N0B00 € 4,586
Puleggia/corona per tubo ottagonale Ø40
Male/female adapter for Ø40 mm octagonal tube



10 pieces per pack (0,3 Kg)

MS35AP02N0B00 € 3,439
Puleggia/corona per tubo tondo Ø40
Male/female adapter for Ø40 mm round tube

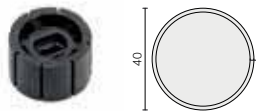

STAFFA CON PERNO QUADRO / BRACKET WITH ROUND PIN

10 pieces per pack (0,76 Kg)

MS45AS01N0G00 € 3,210
Staffa con perno quadro - Zincato Bianco
Bracket with round pin - White Galvanized

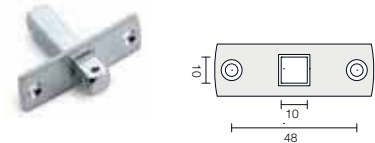

STAFFE DI SUPPORTO. ZINCATO BIANCO / SUPPORT BRACKETS. WHITE GALVANIZED

10 pieces per pack (0,65 Kg)

MS45AS02N0G00 € 3,439
Staffa di supporto max 50Nm interasse 48 mm
Support bracket, max 50Nm centre distance 48 mm

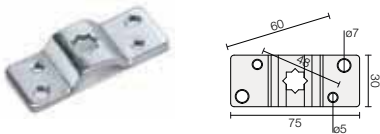

10 pieces per pack (2,50 Kg)

MS45AS04N0G00 € 4,012
Staffa di supporto regolabile a vite
Screw-adjustable support bracket

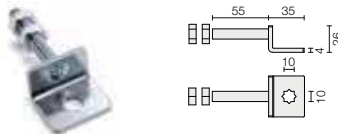

10 pieces per pack (2,62 Kg)

MS45AS05N0G00 € 10,891
Staffa di supporto quadra
Square section support bracket



10 pieces per pack (1,00 Kg)

MS45AS06N0G00 € 5,503
Staffa di supporto regolabile asola zincata
Adjustable support bracket

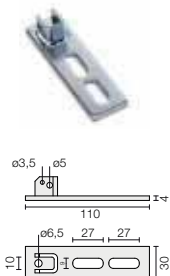

10 pieces per pack (1,00 Kg)

MS45AS07N0G00 € 10,776
Staffa di supporto regolare c/copiglia zincata
Support bracket

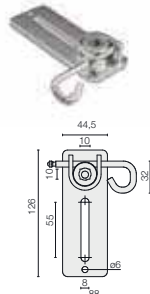

10 pieces per pack (1,00 Kg)

MS45AS08N0G00 € 14,158
Staffa di supporto quadra c/copiglia zincata
Support bracket

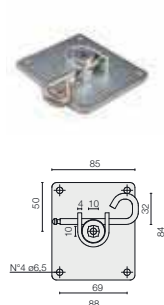

10 pieces per pack (1,00 Kg)

MS45AS09N0G00 € 14,330
Staffa di supporto regolare c/copiglia zincata
Support bracket

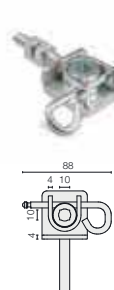

10 pieces per pack (1,00 Kg)

MS45AS10N0G00 € 5,503
Staffa di supporto a bandiera c/copiglia zincata
Support bracket

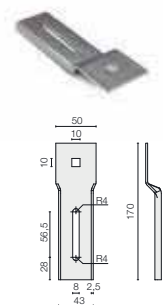



- Rilevamento ostacoli | *Obstacle detection*
- Servizio | *Type of service* S2 - 4 min
- Temp min-max -5°C / +50°C

IP44

SHOWIN S45 Ø45mm

📄	PRODUCT CODE	DESCRIPTION	📄	📄	C.C.	€
S45 10N	MS45SM10H0B00	SHOWIN MOTORIDUTTORE Ø45 10NM	1	2,20	8D	€ 68,783
S45 20N	MS45SM20H0B00	SHOWIN MOTORIDUTTORE Ø45 20NM	1	2,28	8D	€ 68,783
S45 M/S 20N	MS45MM20H0B00	SHOWIN MOTORIDUTTORE M/SOC Ø45 20NM	1	3,00	8D	€ 108,907
S45 C/RIC 20N	MS45RM20H0B00	SHOWIN MOTORIDUTTORE C/RIC Ø45 20NM	1	2,50	8D	€ 176,544
S45 30N	MS45SM30H0B00	SHOWIN MOTORIDUTTORE Ø45 30NM	1	2,68	8D	€ 79,101
S45 M/S 30N	MS45MM30H0B00	SHOWIN MOTORIDUTTORE M/SOC Ø45 30NM	1	3,00	8D	€ 112,346
S45 C/RIC 30N	MS45RM30H0B00	SHOWIN MOTORIDUTTORE C/RIC Ø45 30NM	1	2,50	8D	€ 182,276
S45 40N	MS45SM40H0B00	SHOWIN MOTORIDUTTORE Ø45 40NM	1	2,78	8D	€ 82,540
S45 M/S 40N	MS45MM40H0B00	SHOWIN MOTORIDUTTORE M/SOC Ø45 40NM	1	3,00	8D	€ 116,932
S45 C/RIC 40N	MS45RM40H0B00	SHOWIN MOTORIDUTTORE C/RIC Ø45 40NM	1	2,50	8D	€ 189,154
S45 50N	MS45SM50H0B00	SHOWIN MOTORIDUTTORE Ø45 50NM	1	2,92	8D	€ 90,565
S45 M/S 50N	MS45MM50H0B00	SHOWIN MOTORIDUTTORE M/SOC Ø45 50NM	1	3,00	8D	€ 123,810
S45 C/RIC 50N	MS45RM50H0B00	SHOWIN MOTORIDUTTORE C/RIC Ø45 50NM	1	2,50	8D	€ 201,765

SHOWIN S45 Accessories

PULEGGIA / ADAPTER



10 pieces per pack (0,8 Kg)
MS45AP01N0B00 € 4,815
 Puleggia/corona per tubo ottagonale Ø60 mm
 Male/female adapter for Ø60 mm octagonal tube



10 pieces per pack (1,9 Kg)
MS45AP02N0B00 € 4,815
 Puleggia/corona per tubo ottagonale Ø60 mm
 Male/female adapter for Ø60 mm octagonal tube



10 pieces per pack (2,0 Kg)
MS45AP03N0B00 € 4,815
 Puleggia/corona per tubo ottagonale Ø70 mm
 Male/female adapter for Ø70 mm octagonal tube



10 pieces per pack (0,9 Kg)
MS45AP04N0B00 € 4,815
 Puleggia/corona per tubo a stella Ø60 mm
 Male/female adapter for Ø60 mm star-section tube



10 pieces per pack (1,1 Kg)
MS45AP05N0B00 € 6,305
 Puleggia per ogiva Ø70 mm
 Male/female adapter for Ø70 mm tube with groove



10 pieces per pack (1,5 Kg)
MS45AP06N0B00 € 7,452
 Puleggia per ogiva Ø78 mm
 Male/female adapter for Ø78 mm tube with groove

NEW



IP44

- Terzo fine-corsa intermedio programmabile
Third programmable intermediate limit switch
- Rilevamento ostacoli programmabile mediante radiocomando.
Obstacle detection programmable by radio control.
- Servizio | *Type of service* S2 - 4 min
- Temp min-max -5°C / +50°C

SHOWIN S45 3FC Ø45mm

	PRODUCT CODE	DESCRIPTION			C.C.	€
S45-30N-3FC	MS45RR30H0B00	SHOWIN MOTORIDUTTORE Ø45 30NM 3° FINECORSA	1	2,60	8D	165,00
S45-50N-3FC	MS45RR50H0B00	SHOWIN MOTORIDUTTORE Ø45 50NM 3° FINECORSA	1	2,85	8D	169,77



Radiocomando incluso nella confezione.
Radio remote control included in the package.



STAFFE DI SUPPORTO. ZINCATO BIANCO / SUPPORT BRACKETS. WHITE GALVANIZED

10 pieces per pack (0,7 Kg)
MS45AS01N0G00 € 3,210
Staffa con perno quadro
Bracket with round pin

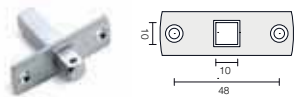

10 pieces per pack (0,6 Kg)
MS45AS02N0G00 € 3,439
Staffa di supporto max 50Nm interasse 48 mm
Support bracket, max 50Nm centre distance 48 mm

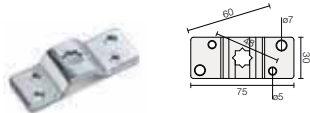

10 pieces per pack (1,1 Kg)
MS45AS04N0G00 € 4,012
Staffa di supporto regolabile a vite
Screw-adjustable support bracket

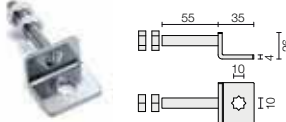

10 pieces per pack (2,5 Kg)
MS45AS09N0G00 € 14,330
Staffa di supporto
Support bracket

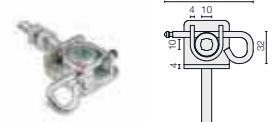

10 pieces per pack (2,4 Kg)
MS45AS05N0G00 € 10,891
Staffa di supporto quadra
Square section support bracket

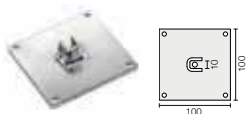

10 pieces per pack (3,00 Kg)
MS45AS08N0G00 € 14,158
Staffa di supporto
Support bracket

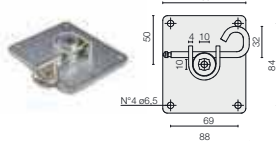

10 pieces per pack (1,0 Kg)
MS45AS06N0G00 € 5,503
Staffa di supporto regolabile
Adjustable support bracket

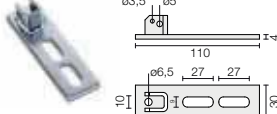

10 pieces per pack (2,2 Kg)
MS45AS07N0G00 € 10,776
Staffa di supporto
Support bracket

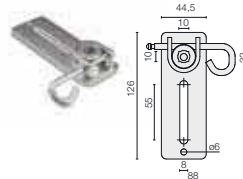

10 pieces per pack (0,6 Kg)
MS45AS10N0G00 € 5,503
Staffa di supporto
Support bracket

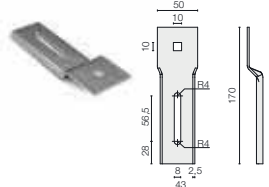



- IP44**
- Rilevamento ostacoli | *Obstacle detection*
- Servizio | *Type of service* **S2 - 4 min**
- Temp min-max **-5°C / +50°C**

SHOWIN S59 Ø59mm

📄	PRODUCT CODE	DESCRIPTION	📄	🔔	C.C.	€
S59 80N	MS59SM80H0B00	SHOWIN MOTORIDUTTORE Ø59 80NM	1	5,70	8D	€ 275,134
S59 M/S 80N	MS59MM80H0B00	SHOWIN MOTORIDUTTORE M/SOC Ø59 80NM	1	5,95	8D	€ 349,649
S59 100N	MS59SM0AH0B00	SHOWIN MOTORIDUTTORE Ø59 100NM	1	5,70	8D	€ 280,866
S59 M/S 100N	MS59MM0AH0B00	SHOWIN MOTORIDUTTORE M/SOC Ø59 100NM	1	5,95	8D	€ 357,674

SHOWIN S59 Accessories

STAFFA DI SUPPORTO / SUPPORT BRACKET

10 pieces per pack (0,6 Kg)

MS59AS03NOG00 € 3,439

Staffa di supporto max 100Nm interasse 48 mm - Zincato Bianco
Support bracket, max 100Nm centre distance 48 mm - White Galvanized

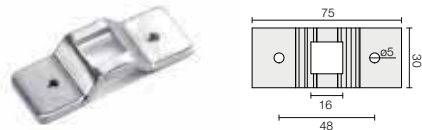

STAFFA DI SUPPORTO / SUPPORT BRACKET

10 pieces per pack (3,5 Kg)

MS59AS04NOG00 € 10,891

Staffa di supporto quadra - Zincato Bianco
Square section support bracket - White Galvanized



STAFFA DI SUPPORTO / SUPPORT BRACKET

10 pieces per pack (2,0 Kg)

MS59AP01NOB00 € 6,305

Puleggia/corona per tubo ottagonale Ø70
Male/female adapter for Ø70 mm octagonal tube



STAFFA DI SUPPORTO / SUPPORT BRACKET

10 pieces per pack (2,0 Kg)

MS59AP02NOB00 € 7,452

Puleggia/corona per ogiva Ø78
Male/female adapter for Ø78 mm tube with groove



REMOTE CONTROL



Mowin® R-Control è il trasmettitore a radio frequenza (434,15 Mhz) capace di attivare tutte le automazioni su sei canali e garantire la gestione di gruppi multipli.

The Mowin® R-Control radio transmitter (434.15 Mhz) runs all automated systems over 6 channels so as to guarantee efficient management of multiple groups.



White



Yellow



Green





Blue



Grey



Orange

	PRODUCT CODE	DESCRIPTION			C.C.	€
R1 CONTROL	MX00AT01NOW00	RADIOCOMANDO A 1CANALE BIANCO	1	0,09	8V	€ 63,051
R6 CONTROL	MX00AT06NOW00	RADIOCOMANDO A 6CANALI BIANCO	1	0,09	8V	€ 74,515
R1 CONTROL	MX00AT01NYW00	RADIOCOMANDO A 1CANALE GIALLO	1	0,09	8V	€ 63,051
R6 CONTROL	MX00AT06NYW00	RADIOCOMANDO A 6CANALI GIALLO	1	0,09	8V	€ 74,515
R1 CONTROL	MX00AT01NWW00	RADIOCOMANDO A 1CANALE VERDE	1	0,09	8V	€ 63,051
R6 CONTROL	MX00AT06NWW00	RADIOCOMANDO A 6CANALI VERDE	1	0,09	8V	€ 74,515
R1 CONTROL	MX00AT01NBW00	RADIOCOMANDO A 1CANALE BLU	1	0,09	8V	€ 63,051
R6 CONTROL	MX00AT06NBW00	RADIOCOMANDO A 6CANALI BLU	1	0,09	8V	€ 74,515
R1 CONTROL	MX00AT01NGW00	RADIOCOMANDO A 1CANALE GRIGIO	1	0,09	8V	€ 63,051
R6 CONTROL	MX00AT06NGW00	RADIOCOMANDO A 6CANALI GRIGIO	1	0,09	8V	€ 74,515
R1 CONTROL	MX00AT01NAW00	RADIOCOMANDO A 1CANALE ARANCIONE	1	0,09	8V	€ 63,051
R6 CONTROL	MX00AT06NAW00	RADIOCOMANDO A 6CANALI ARANCIONE	1	0,09	8V	€ 74,515

WBUS



WBUS GATE è un dispositivo di telecontrollo wireless con web server integrato, basato su rete cellulare dati GSM / GPRS / HSPA e LAN, WLAN che consente il monitoraggio continuo non presidiato di grandezze elettriche di processo ed il comando remoto degli attuatori elettrici WBUS ed altri sistemi elettronici.

WBUS GATE is a wireless remote monitoring device with an integrated web server capable of working over GSM / GPRS / HSPA cellular and LAN / WLAN data networks. The unit provides fully-automated constant monitoring over electrical process parameters as well as the remote control of WBUS electronic actuators and other electronic systems.



MOWIN^K
OPENAPP

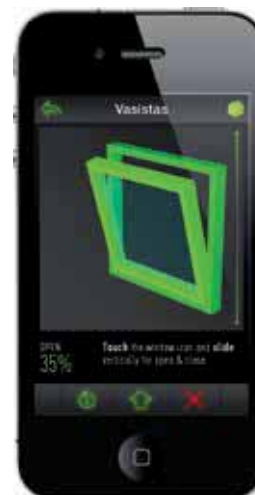

L'OpenAPP consente all'utente di comunicare con la centrale di controllo WBUS GATE collegata nel proprio impianto WBUS.
Users can communicate with the WBUS GATE control unit connected to their WBUS system via the OpenAPP application.

WBUS

	PRODUCT CODE	DESCRIPTION			C.C.	€
	WBUS LAN+2G	MX00WB03H0B00 CENTRALE WBUS 2G	1	0,80	8V	€ 3.335,768
	WBUS LAN+2G+WIFI	MX00WB04H0B00 CENTRALE WBUS 2G+WIFI	1	0,80	8V	€ 3.743,407
	WBUS LAN+3G	MX00WB05H0B00 CENTRALE WBUS 3G	1	0,80	8V	€ 3.712,054
	WBUS LAN+3G+WIFI	MX00WB06H0B00 CENTRALE WBUS 3G+WIFI	1	0,80	8V	€ 4.119,704
	WBUS LAN+DUAL/2G	MX00WB07H0B00 CENTRALE WBUS DUAL 2G	1	0,80	8V	€ 3.868,839
	WBUS LAN+DUAL/2G+WIFI	MX00WB08H0B00 CENTRALE WBUS DUAL 2G+WIFI	1	0,80	8V	€ 4.276,489
	SCHEDA WBUS R-230	MX00WB09H0B00 SCHEDA WBUS R230	1	0,14	8V	€ 108,150



LIWIN 350N WBUS 230V

	PRODUCT CODE	DESCRIPTION			C.C.	€
L35-230V WBUS	ML35WB40H0B00	■ LIWIN L35 WBUS 230V- BLACK	1	1,23	8A	€ 202,241
L35-230V WBUS	ML35WB40H0G00	■ LIWIN L35 WBUS 230V-GREY	1	1,23	8A	€ 202,241
L35-230V WBUS	ML35WB40H0W00	□ LIWIN L35 WBUS 230V-WHITE	1	1,23	8A	€ 202,241

LIWIN 350N WBUS RADIO

	PRODUCT CODE	DESCRIPTION			C.C.	€
L35-230V WBUS+R	ML35RB40H0B00	■ LIWIN L35 WBUS RADIO 230V- BLACK	1	1,23	8A	€ 247,664
L35-230V WBUS+R	ML35RB40H0G00	■ LIWIN L35 WBUS RADIO 230V-GREY	1	1,23	8A	€ 247,664
L35-230V WBUS+R	ML35RB40H0W00	□ LIWIN L35 WBUS RADIO 230V-WHITE	1	1,23	8A	€ 247,664

LIWIN 350N WBUS 24V

	PRODUCT CODE	DESCRIPTION			C.C.	€
L35-24V WBUS	ML35WB40L0B00	■ LIWIN L35 WBUS 24V- BLACK	1	1,23	8A	€ 190,344
L35-24V WBUS	ML35WB40L0G00	■ LIWIN L35 WBUS 24V-GREY	1	1,23	8A	€ 190,344
L35-24V WBUS	ML35WB40L0W00	□ LIWIN L35 WBUS 24V-WHITE	1	1,23	8A	€ 190,344

LIWIN 350N WBUS 24V RADIO

	PRODUCT CODE	DESCRIPTION			C.C.	€
L35-24V WBUS+R	ML35RB40L0B00	■ LIWIN L35 WBUS RADIO 24V- BLACK	1	1,23	8A	€ 234,686
L35-24V WBUS+R	ML35RB40L0G00	■ LIWIN L35 WBUS RADIO 24V-GREY	1	1,23	8A	€ 234,686
L35-24V WBUS+R	ML35RB40L0W00	□ LIWIN L35 WBUS RADIO 24V-WHITE	1	1,23	8A	€ 234,686





AIRWIN 650N WBUS 230V

	PRODUCT CODE	DESCRIPTION			C.C.	€
A65/180-230V WBUS	MA65WB18H0G00	AIRWIN A65-180/230V WBUS	1	1,70	8C	€ 325,532
A65/230-230V WBUS	MA65WB23H0G00	AIRWIN A65-230/230V WBUS	1	1,75	8C	€ 333,837
A65/350-230V WBUS	MA65WB35H0G00	AIRWIN A65-350/230V WBUS	1	1,90	8C	€ 339,353
A65/550-230V WBUS	MA65WB55H0G00	AIRWIN A65-550/230V WBUS	1	2,25	8C	€ 342,954
A65/750-230V WBUS	MA65WB75H0G00	AIRWIN A65-750/230V WBUS	1	2,75	8C	€ 346,253
A65/1000-230V WBUS	MA65WB0AH0G00	AIRWIN A65-1000/230V WBUS	1	3,00	8C	€ 359,664



AIRWIN 650N WBUS 230V RADIO

	PRODUCT CODE	DESCRIPTION			C.C.	€
A65/180-230V WBUS+R	MA65RB18H0G00	AIRWIN A65-180/230V WBUS RADIO	1	1,70	8C	€ 368,835
A65/230-230V WBUS+R	MA65RB23H0G00	AIRWIN A65-230/230V WBUS RADIO	1	1,75	8C	€ 378,146
A65/350-230V WBUS+R	MA65RB35H0G00	AIRWIN A65-350/230V WBUS RADIO	1	1,90	8C	€ 383,662
A65/550-230V WBUS+R	MA65RB55H0G00	AIRWIN A65-550/230V WBUS RADIO	1	2,25	8C	€ 387,253
A65/750-230V WBUS+R	MA65RB75H0G00	AIRWIN A65-750/230V WBUS RADIO	1	2,75	8C	€ 389,956
A65/1000-230V WBUS+R	MA65RB0AH0G00	AIRWIN A65-1000/230V WBUS RADIO	1	3,00	8C	€ 403,962

AIRWIN 650N WBUS 24V



	PRODUCT CODE	DESCRIPTION			C.C.	€
A65/180-24V WBUS	MA65WB18LOG00	AIRWIN A65-180/24V WBUS	1	1,70	8C	€ 320,135
A65/230-24V WBUS	MA65WB23LOG00	AIRWIN A65-230/24V WBUS	1	1,75	8C	€ 329,447
A65/350-24V WBUS	MA65WB35LOG00	AIRWIN A65-350/24V WBUS	1	1,90	8C	€ 334,962
A65/550-24V WBUS	MA65WB55LOG00	AIRWIN A65-550/24V WBUS	1	2,25	8C	€ 338,564
A65/750-24V WBUS	MA65WB75LOG00	AIRWIN A65-750/24V WBUS	1	2,75	8C	€ 341,267
A65/1000-24V WBUS	MA65WB0ALOG00	AIRWIN A65-1000/24V WBUS	1	3,00	8C	€ 355,273

AIRWIN 650N WBUS 24V RADIO



	PRODUCT CODE	DESCRIPTION			C.C.	€
A65/180-24V WBUS+R	MA65RB18LOG00	AIRWIN A65-180/24V WBUS RADIO	1	1,70	8C	€ 364,444
A65/230-24V WBUS+R	MA65RB23LOG00	AIRWIN A65-230/24V WBUS RADIO	1	1,75	8C	€ 373,756
A65/350-24V WBUS+R	MA65RB35LOG00	AIRWIN A65-350/24V WBUS RADIO	1	1,90	8C	€ 379,271
A65/550-24V WBUS+R	MA65RB55LOG00	AIRWIN A65-550/24V WBUS RADIO	1	2,25	8C	€ 382,862
A65/750-24V WBUS+R	MA65RB75LOG00	AIRWIN A65-750/24V WBUS RADIO	1	2,75	8C	€ 385,566
A65/1000-24V WBUS+R	MA65RB0ALOG00	AIRWIN A65-1000/24V WBUS RADIO	1	3,00	8C	€ 399,571





RAYWIN 600N WBUS 230V

	PRODUCT CODE	DESCRIPTION			C.C.	€
R60/300-230V WBUS	MR60WB30HOG00	RAYWIN R60/300-230V WBUS	1	1,90	8B	€ 285,754
R60/500-230V WBUS	MR60WB50HOG00	RAYWIN R60/500-230V WBUS	1	2,30	8B	€ 297,413

RAYWIN 600N WBUS 230V RADIO

	PRODUCT CODE	DESCRIPTION			C.C.	€
R60/300-230V WBUS+R	MR60RB30HOG00	RAYWIN R60/300-230V WBUS RADIO	1	1,90	8B	€ 330,063
R60/500-230V WBUS+R	MR60RB50HOG00	RAYWIN R60/500-230V WBUS RADIO	1	2,30	8B	€ 341,516

RAYWIN 600N WBUS 24V

	PRODUCT CODE	DESCRIPTION			C.C.	€
R60/300-24V WBUS	MR60WB30LOG00	RAYWIN R60/300-24V WBUS	1	1,90	8B	€ 275,534
R60/500-24V WBUS	MR60WB50LOG00	RAYWIN R60/500-24V WBUS	1	2,30	8B	€ 286,598

RAYWIN 600N WBUS 24V RADIO

	PRODUCT CODE	DESCRIPTION			C.C.	€
R60/300-24V WBUS+R	MR60RB30LOG00	RAYWIN R60/300-24V WBUS RADIO	1	1,90	8B	€ 319,832
R60/500-24V WBUS+R	MR60RB50LOG00	RAYWIN R60/500-24V WBUS RADIO	1	2,30	8B	€ 329,858

NEW



Centrale per il controllo di due motori per finestre 230V in parallelo (senza sincronismo dello sfasamento). Blocco dei motori per amperometrica.
Control unit for 230V windows actuators (in parallel connection, without synchronization of the phase shift). Actuators block through amperometric threshold.

- Alimentazione / Power supply 230V 50Hz (max 2x22W)
- Temp min-max -10°C / +50°C

TWIN 230V

	PRODUCT CODE	DESCRIPTION			C.C.	€
TWIN	MP00E003H0000	CENTRALINA DI ACCOPIAMENTO TWIN	1	0,2	8C	66,67

NEW



Modulo a relè di comando locale e centralizzato singolo motore 230V (per collegamento serie di più motori).
Relay module for local and main command, single motor 230V output (useful for connection series of several motors).

- Alimentazione / Power supply 230V 50Hz (max 10 A cosφ=1; 4 A cosφ=0.4)
- Temp min-max -10°C / +50°C

SCHEDA DECOUPLER

	PRODUCT CODE	DESCRIPTION			C.C.	€
AF950	MP00X003H0000	SCHEDA DECOUPLER 230V 5A RELAIS	1	0,4	8C	71,566

GATE

CODE	ART.	CAT.	PAG.	CODE	ART.	CAT.	PAG.	CODE	ART.	CAT.	PAG.
10100505 001	2	1C	34	11210030	73-30	1N	39	10802215 001	88PST-60	1A	42
10100610 001	2C	1C	34	11210005	73-40	1N	39	10802005	89-40	1A	43
10100615 001	2C	1C	34	11210010	73-50	1N	39	10802010	89-50	1A	43
10101005 001	4	1C	34	11210015	73-60	1N	39	10802015	89-60	1A	43
10101110 001	4C	1C	34	11210020 503	73-10	1N	39	10802505	90P	1A	43
10101115 001	4C	1C	34	11210025 503	73-20	1N	39	10802510	90G	1A	43
10102005 001	8	1C	34	11210030 503	73-30	1N	39	10803005	92G	1A	43
10102110 001	8C	1C	34	11210005 503	73-40	1N	39	10803505 001	94P	1A	43
10102115 001	8C	1C	34	11210010 503	73-50	1N	39	10803510 001	94G	1A	43
10102505 001	10	1C	35	11210015 503	73-60	1N	39	10804005 001	96G	1A	43
10102610 001	10C	1C	35	11210520	74-10	1N	39	10804505	100P	1A	43
10102615 001	10C	1C	35	11210525	74-20	1N	39	10804510	100G	1A	43
10103610 001	16C	1C	35	11210530	74-30	1N	39	10804605 001	100PST-P	1A	44
10103615 001	16C	1C	35	11210505	74-40	1N	39	10804610 001	100PST-G	1A	44
10104610 001	20C	1C	35	11210510	74-50	1N	39	10805005	105-20	1A	44
10104615 001	20C	1C	35	11210515	74-60	1N	39	10805105 001	105PST-20	1A	44
10605005 001	22	1L	35	11210520 503	74-10	1N	39	10805205 001	106-20	1A	44
10605000 001	22	1L	35	11210525 503	74-20	1N	39	10805210 001	106-27	1A	44
10605010 001	22	1L	35	11210530 503	74-30	1N	39	10805305 001	106PST-20	1A	44
10605505 001	23	1I	35	11210505 503	74-40	1N	39	10805310 001	106PST-27	1A	44
10605500 001	23	1I	35	11210510 503	74-50	1N	39	10805505	110-20	1A	45
10605510 001	23	1I	35	11210515 503	74-60	1N	39	10805510	110-24	1A	45
10200505 001	24	1I	36	11213505	78	1N	39	10805515	110-27	1A	45
10200510 001	24	1I	36	11213505 502	78	1N	39	10806005	115-20,5	1A	45
10200515 001	24	1I	36	10800407 001	85M	1A	40	10806010	115-24,5	1A	45
10704810 001	25	1I	36	10800410 001	85G	1A	40	10806015	115-28	1A	45
10704805 001	25	1I	36	10801607 001	85L-M	1A	40	10806405 001	115PST-20,5	1A	45
10300505 001	26	1L	36	10801610 001	85L-G	1A	40	10806410 001	115PST-24,5	1A	45
10300510 001	26	1L	36	10801407 001	85PST-M	1A	40	10806415 001	115PST-28	1A	45
10301005 001	28	1L	36	10801410 001	85PST-G	1A	40	10807305 001	117-20,5	1A	45
10301010 001	28	1L	36	10800505 001	86P	1A	40	10807310 001	117-24,5	1A	45
10301505 001	30-25	1L	36	10800411 001	85XL	1A	40	10807315 001	117-28	1A	45
10400505 001	32-34	1L	36	10800510 001	86G	1A	41	10807405 001	117PST-20,5	1A	45
10500505 001	34-M12	1L	36	10801805 001	86L-P	1A	41	10807410 001	117PST-24,5	1A	45
10500510 001	34-M20	1L	36	10801810 001	86L-G	1A	41	10807415 001	117PST-28	1A	45
10302005 001	36-25	1L	37	10801710 001	86PST-G	1A	41	10806501 001	120-M16	1A	45
10302010 001	36-30	1L	37	10801005 001	87P	1A	41	10806500 001	120-M18	1A	45
10105505 001	38-24	1C	37	10801007 001	87M	1A	41	10806505 001	120-M20	1A	45
10106005 001	39-24	1C	37	10801010 001	87G	1A	41	10806509 001	120-M22	1A	45
10106505 001	40-24	1C	37	10801305 001	87L-P	1A	41	10806510 001	120-M24	1A	45
10107005 001	41-24	1C	37	10801307 001	87L-M	1A	41	10806505 020	120-M20 Hs700	1A	45
10501005 001	42 P	1L	37	10801310 001	87L-G	1A	41	10806510 020	120-M24 Hs700	1A	45
10501010 001	42 G	1L	37	10801205 001	87PST-P	1A	42	10807004 001	125-M18	1A	46
10107505 001	43-24	1C	38	10801207 001	87PST-M	1A	42	10807005 001	125-M20	1A	46
10108005 001	43-24	1C	38	10801210 001	87PST-G	1A	42	10807009 001	125-M22	1A	46
10108505 001	46-24	1C	38	10801505 001	88-40	1A	42	10807010 001	125-M24	1A	46
10109005 001	48-24	1C	38	10801510 001	88-50	1A	42	10807504 001	130-M18	1A	46
10109505 001	50-24	1C	38	10801515 001	88-60	1A	42	10807505 001	130-M20	1A	46
10110005 001	52-24	1C	38	10801011 001	87XL	1A	42	10807509 001	130-M22	1A	46
10110505 001	54-24	1C	39	10802105 001	88L-40	1A	42	10807510 001	130-M24	1A	46
10111005 001	56-24	1C	39	10802110 001	88L-50	1A	42	10808001 001	135-M16	1A	46
10111505 001	60-24	1C	39	10802115 001	88L-60	1A	42	10808005 001	135-M18	1A	46
11210020	73-10	1N	39	10802205 001	88PST-40	1A	42	10808009 001	135-M20	1A	46
11210025	73-20	1N	39	10802210 001	88PST-50	1A	42	10808010 001	135-M22	1A	46



CODE	ART.	CAT.	PAG.
10808014 001	135-M24	1A	46
10808015 001	135-M27	1A	46
10808505 001	140-M18	1A	46
10808509 001	140-M20	1A	46
10808510 001	140-M22	1A	46
10808512 001	140-M24	1A	46
10808515 001	140-M27	1A	46
10809005 001	150-M18	1A	46
10809009 001	150-M20	1A	46
10809010 001	150-M22	1A	46
10809012 001	150-M24	1A	46
10824705 001	154-M18	1A	46
10824710 001	154-M20	1A	46
10824715 001	154-M22	1A	46
10824720 001	154-M24	1A	46
10824725 001	154-M27	1A	46
10824305 001	154R-CV-M18	1A	47
10824310 001	154R-CV-M20	1A	47
10824315 001	154R-CV-M22	1A	47
10824320 001	154R-CV-M24	1A	47
10809501 001	155-M16	1A	47
10809601 001	155-M18	1A	47
10809505 001	155-M20	1A	47
10809512 001	155-M22	1A	47
10809510 001	155-M24	1A	47
10809502 001	155B-M16	1A	47
10809503 001	155B-M18	1A	47
10809508 001	155B-M20	1A	47
10809509 001	155B-M22	1A	47
10809511 001	155B-M24	1A	47
10824605 001	157CV-M18	1A	47
10824610 001	157CV-M20	1A	47
10824615 001	157CV-M22	1A	47
10824620 001	157CV-M24	1A	47
10824505 001	157-M18	1A	47
10824510 001	157-M20	1A	47
10824515 001	157-M22	1A	47
10824520 001	157-M24	1A	47
10824905 001	157-AL-M18	1A	48
10824910 001	157-AL-M20	1A	48
10824915 001	157-AL-M22	1A	48
10824920 001	157-AL-M24	1A	48
10823501 001	159-M16	1A	48
10823505 001	159-M18	1A	48
10823510 001	159-M20	1A	48
10823515 001	159-M22	1A	48
10823520 001	159-M24	1A	48
10823525 001	159-M27	1A	48
10823405 001	159R-CV-M18	1A	48
10823410 001	159R-CV-M20	1A	48
10823415 001	159R-CV-M22	1A	48
10823420 001	159R-CV-M24	1A	48
10810004 001	160-M16	1A	48
10810005 001	160-M18	1A	48

CODE	ART.	CAT.	PAG.
10810009 001	160-M20	1A	48
10810010 001	160-M22	1A	48
10810012 001	160-M24	1A	48
10810015 001	160-M27	1A	48
10810007 001	160B-M16	1A	48
10810008 001	160B-M18	1A	48
10810011 001	160B-M20	1A	48
10810013 001	160B-M22	1A	48
10810014 001	160B-M24	1A	48
10810016 001	160B-M27	1A	48
10801912 001	160XL	1A	49
10810301 001	161-M16	1A	49
10810300 001	161-M18	1A	49
10810305 001	161-M20	1A	49
10810309 001	161-M22	1A	49
10810310 001	161-M24	1A	49
10810505 001	162-M20	1A	49
10810510 001	162-M24	1A	49
10810801 001	163-M16	1A	49
10810805 001	163-M18	1A	49
10810809 001	163-M20	1A	49
10810810 001	163-M22	1A	49
10810814 001	163-M24	1A	49
10810815 001	163-M27	1A	49
10811005 001	164-M18	1A	49
10811010 001	164-M22	1A	49
10811015 001	164-M27	1A	49
12100505	165-30	1G	50
12100510	165-40	1G	50
12100515	165-50	1G	50
12100520	165-60	1G	50
12100525	165-80	1G	50
12100530	165-100	1G	50
12100535	165-120	1G	50
12100540	165-150	1G	50
12100550	165-200	1G	50
12100505 001	165Z-30	1G	50
12100510 001	165Z-40	1G	50
12100515 001	165Z-50	1G	50
12100520 001	165Z-60	1G	50
12100525 001	165Z-80	1G	50
12100530 001	165Z-100	1G	50
12100535 001	165Z-120	1G	50
12100540 001	165Z-150	1G	50
12100550 001	165Z-200	1G	50
12100560	165R-20x30	1G	50
12100561	165R-20x40	1G	50
12100562	165R-30x50	1G	50
12100563	165R-30x60	1G	50
12100564	165R-40x60	1G	50
12100565	165R-40x80	1G	50
12100560 001	165RZ-20x30	1G	50
12100561 001	165RZ-20x40	1G	50
12100562 001	165RZ-30x50	1G	50

CODE	ART.	CAT.	PAG.
12100563 001	165RZ-30x60	1G	50
12100564 001	165RZ-40x60	1G	50
12100565 001	165RZ-40x80	1G	50
12100805	165T-30	1G	50
12100810	165T-33	1G	50
12100815	165T-42	1G	50
12100820	165T-48	1G	50
12100830	165T-76	1G	50
12100835	165T-89	1G	50
12100845	165T-114	1G	50
12100420	165S-100	1G	50
12100425	165S-120	1G	50
12100430	165S-150	1G	50
12100405	165S-50	1G	50
12100410	165S-60	1G	50
12100415	165S-80	1G	50
12100205	165N-12	1G	51
12100206	165N-15	1G	51
12100210	165N-20	1G	51
12100215	165N-25	1G	51
12100216	165N-30	1G	51
12100217	165N-35	1G	51
12100220	165N-40	1G	51
12100221	165N-45	1G	51
12100225	165N-50	1G	51
12100226	165N-60	1G	51
12100227	165N-70	1G	51
12100228	165N-80	1G	51
12100229	165N-100	1G	51
12100304	165RN-20X100	1G	51
12100303	165RN-15X30	1G	51
12100305	165RN-20X30	1G	51
12100310	165RN-20X40	1G	51
12100311	165RN-20X50	1G	51
12100312	165RN-20X60	1G	51
12100320	165RN-25X40	1G	51
12100315	165RN-25X50	1G	51
12100313	165RN-30X120	1G	51
12100314	165RN-30X40	1G	51
12100316	165RN-30X50	1G	51
12100317	165RN-30X60	1G	51
12100318	165RN-30X80	1G	51
12100319	165RN-40X100	1G	51
12100321	165RN-40X120	1G	51
12100322	165RN-40X50	1G	51
12100323	165RN-40X60	1G	51
12100324	165RN-40X80	1G	51
12100325	165RN-50X100	1G	51
12100326	165RN-50X120	1G	51
12100327	165RN-50X150	1G	51
12100328	165RN-50X80	1G	51
12100100	165TN-15	1G	51
12100105	165TN-20	1G	51
12100110	165TN-25	1G	51

GATE

CODE	ART.	CAT.	PAG.
12100111	165TN-30	1G	51
12100112	165TN-35	1G	51
12100115	165TN-40	1G	51
12100116	165TN-45	1G	51
12100120	165TN-50	1G	51
12100121	165TN-60	1G	51
12100122	165TN-70	1G	51
12100123	165TN-80	1G	51
12100124	165TN-100	1G	51
10704601 001	166P	1G	51
10704602 001	166G	1G	51
10700705 001	167	1G	52
10700905 001	169	1G	52
10701005 001	170	1G	52
10701205 001	171	1G	52
10821005 001	172-M18	1A	52
10821010 001	172-M20	1A	52
10821015 001	172-M24	1A	52
10820005 001	174-M16	1A	52
19926003	175P	1A	53
19926004	175G	1A	53
10820505 001	176-M16	1A	53
10819505 001	178-M12	1A	53
10819510 001	178-M16	1A	53
10819515 001	178-M20	1A	53
10819520 001	178-M24	1A	53
10814005 001	180-M18	1A	54
10814010 001	180-M22	1A	54
10814015 001	180-M27	1A	54
10814505 001	182-M18	1A	54
10814510 001	182-M22	1A	54
10814515 001	182-M27	1A	54
10814506 001	182B-M18	1A	54
10814507 001	182B-M22	1A	54
10824516 001	182B-M27	1A	54
10814605 001	183-M18 30x30	1A	54
10814610 001	183-M20 35x35	1A	54
10814615 001	183-M24 40x40	1A	54
10814625 001	183-M24 50x50	1A	54
10815005 001	184-M18	1A	54
10815010 001	184-M22	1A	54
10815015 001	184-M27	1A	54
10817505 001	185-M18	1A	55
10817510 001	185-M22	1A	55
10817515 001	185-M27	1A	55
10815505 001	186-M18	1A	55
10815510 001	186-M22	1A	55
10815515 001	186-M27	1A	55
10815605 001	187-M18 30x30	1A	55
10815610 001	187-M20 35x35	1A	55
10815615 001	187-M24 40x40	1A	55
10815625 001	187-M24 50x50	1A	55
10816005 001	188-M18	1A	55
10816010 001	188-M22	1A	55

CODE	ART.	CAT.	PAG.
10816015 001	188-M27	1A	55
10822018 001	189-M18	1A	55
10822020 001	189-M20	1A	55
10822022 001	189-M22	1A	55
10822024 001	189-M24	1A	55
10822027 001	189-M27	1A	55
10816505	190-30	1A	55
10816510	190-35	1A	55
10816515	190-40	1A	55
10817005	192-30	1A	56
10817010	192-35	1A	56
10817015	192-40	1A	56
10818005	194-30	1A	56
10818010	194-35	1A	56
10818015	194-40	1A	56
10818020	194-50	1A	56
10818101 001	194PST	1A	56
10818505	196-30	1A	56
10818510	196-35	1A	56
10818515	196-40	1A	56
10701520 001	195-400	1A	56
10701530 001	195-500	1A	56
10701540 001	195-600	1A	56
10701550 001	195-700	1A	56
10200108 001	197	1A	56
10819005	198-30	1A	57
10819010	198-35	1A	57
10819015	198-40	1A	57
10704701	199-40	1G	57
10704705	199-50	1G	57
10704710	199-60	1G	57
10701505 001	200P	1G	57
10701510 001	200G	1G	57
10701810 001	202	1G	57
10701450 001	201	1G	57
10704301 001	202F-B	1G	58
10704201 001	202F-A	1G	58
10704301 001	202F-C	1G	58
10900505	205	1H	58
10906601 503	209	1H	58
10906601 604	209	1H	58
10704501 001	203	1G	59
10704550 001	204	1G	59
10901005 503	210-25-35	1H	59
10901005 516	210-25-35	1H	59
10901010 503	210-40-50	1H	59
10901010 516	210-40-50	1H	59
10901015 503	210-50-60	1H	59
10901015 516	210-50-60	1H	59
10901020 503	210-60-70	1H	59
10901020 516	210-60-70	1H	59
10901305 503	211	1H	59
10901305 516	211	1H	59
10970005 503	212	1H	60

CODE	ART.	CAT.	PAG.
10905501 503	213	1H	60
11200501 001	215-50	1N	60
11200505 001	215-60	1N	60
11200601 001	215S-50	1N	60
11200605 001	215S-60	1N	60
11201005 001	216	1N	60
11201701	217-40	1N	60
11201705	217-50	1G	60
11201710	217-60	1G	60
11202005	220-40	1G	61
11202010	220-50	1G	61
11215530 001	222-30	1N	61
11215535 001	222-35	1N	61
11215540 001	222-40	1N	61
11215545 001	222-45	1N	61
11215550 001	222-50	1N	61
11215560 001	222-60	1N	61
11215531 001	223-30	1N	61
11215536 001	223-35	1N	61
11215541 001	223-40	1N	61
11215546 001	223-45	1N	61
11215551 001	223-50	1N	61
11215556 001	223-60	1N	61
11300505 001	227-30	1L	61
11300510 001	227-42	1L	61
11301021 001	228-30	1L	61
11301031 001	228-40	1L	61
11301041 001	228-50	1L	61
11301005 001	230-25	1L	61
11301010 001	230-30	1L	61
11301015 001	230-40	1L	61
11301017 001	230-41	1L	61
11301020 001	230-42	1L	61
11301505 001	231-52	1L	62
11302210 001	232-30	1L	62
11302215 001	232-40	1L	62
11302005 001	235-35	1L	62
11302010 001	240-37,5	1L	62
11302505 001	242-37,5	1L	62
11303005 001	243-25	1L	62
11303010 001	243-30	1L	62
11303015 001	243-40	1L	62
11303505 001	243-25	1L	62
11303510 001	243-30	1L	62
11303515 001	243-40	1L	62
11303505 001	244-25	1L	63
11303510 001	244-30	1L	63
11303515 001	244-40	1L	63
11304005 001	245-32	1L	63
11304010 001	245-35	1L	63
11304015 001	245-42	1L	63
11305005 001	247	1L	63
11305008 001	247F	1L	63
11305505 001	250-220	1L	63



CODE	ART.	CAT.	PAG.
11305805 001	251-220	1L	63
11305810 001	251-300	1L	63
11306205 001	252-200	1L	64
11305701 001	253-40	1L	64
11306005 001	255-220	1L	64
11306010 001	255-350	1L	64
11305905 001	256-220	1L	64
11305910 001	256-300	1L	64
11306510 001	257-300	1L	65
11306515 001	257-400	1L	65
11306520 001	257-500	1L	65
11306525 001	257-600	1L	65
11306530 001	257-700	1L	65
11306535 001	257-800	1L	65
11400505 001	260-22x22	1F	65
11400510 001	260-22x22	1F	65
11400515 001	260-30x30	1F	65
11400518 001	260-30x30	1F	65
11306405 001	258-30	1L	65
11400101	261-26x20	1F	65
11401205 001	262-30x8	1F	65
11401005 001	262-30x12	1F	65
11401010 001	262-30x12	1F	65
11401710 001	263	1F	66
11401505 001	264	1F	66
11402001	265	1F	66
11402005	265	1F	66
11402505 001	266	1F	66
10902005 001	270P	1H	66
10902010 001	270G	1H	66
10903005 001	272	1H	66
10702005 001	275	1G	67
10702010 001	275F-30	1G	67
10702015 001	275F-40	1G	67
10702020 001	275F-50	1G	67
10702025 001	275F-60	1G	67
10701401 001	276	1G	67
10701301 001	275PST	1G	67
10812005 001	282-30x30	1A	67
10813005 001	285-30x30	1A	68
10204001 001	287P-Ø15-Sp3	1I	68
10204011 001	287P-Ø15-Sp3	1I	68
10204002 001	287P-Ø15-Sp3	1I	68
10204012 001	287P-Ø15-Sp3	1I	68
10204018 001	287-Ø17-Sp3	1I	68
10204020 001	287-Ø17-Sp3	1I	68
10204013 001	287G-Ø19-Sp3	1I	68
10204007 001	287G-Ø19-Sp3	1I	68
10204014 001	287G-Ø19-Sp3	1I	68
10204008 001	287G-Ø19-Sp3	1I	68
10204015 001	287G-Ø19-Sp4	1I	68
10204009 001	287G-Ø19-Sp4	1I	68
10204016 001	287G-Ø19-Sp4	1I	68
10204010 001	287G-Ø19-Sp4	1I	68

CODE	ART.	CAT.	PAG.
10204201 001	287FP-G	1I	68
10204202 001	287FP-G	1I	68
10201501 001	289P-Ø15-Sp3	1I	68
10201502 001	289P-Ø15-Sp3	1I	68
10201505 001	289G-Ø19-Sp3	1I	68
10201510 001	289G-Ø19-Sp3	1I	68
10201517 001	289LG-19-sp3	1I	68
10601501 001	290	1I	68
10602005 001	291	1I	69
10201905 001	292	1I	69
10201910 001	292	1I	69
10201705 001	293	1I	69
10201710 001	293	1I	69
10602205 001	294	1I	69
10602405 001	295	1I	69
10601605 001	297	1I	69
10601610 001	297G	1I	69
11501001 001	300V-40	1M	69
11501005 001	300V-50	1M	69
11501010 001	300V-60	1M	69
11501015 001	300V-70	1M	69
11501020 001	300V-80	1M	69
11501030 001	300V-90	1M	69
11501040 001	300V-100	1M	69
11501050 001	300V-120	1M	69
11501060 001	300V-140	1M	69
11501070 001	300V-160	1M	69
11501080 001	300V-200	1M	69
11500501 001	300U-40	1M	68
11500505 001	300U-50	1M	68
11500510 001	300U-60	1M	70
11500515 001	300U-70	1M	70
11500520 001	300U-80	1M	70
11500530 001	300U-90	1M	70
11500540 001	300U-100	1M	70
11500550 001	300U-120	1M	70
11500560 001	300U-140	1M	70
11500570 001	300U-160	1M	70
11500580 001	300U-200	1M	70
11502040 001	305V-100	1M	70
11502050 001	305V-120	1M	70
11502060 001	305V-140	1M	70
11502070 001	305V-160	1M	70
11502080 001	305V-200	1M	70
11501540 001	305U-100	1M	70
11501550 001	305U-120	1M	70
11501560 001	305U-140	1M	70
11501570 001	305U-160	1M	70
11501580 001	305U-200	1M	70
11502510 001	306Y-60	1M	70
11502520 001	306Y-80	1M	70
11502530 001	306Y-90	1M	70
11502540 001	306Y-100	1M	70
11502550 001	306Y-120	1M	70

CODE	ART.	CAT.	PAG.
11502560 001	306Y-140	1M	70
11502570 001	306Y-160	1M	70
11502580 001	306Y-200	1M	70
11503040 001	307Y-100	1M	70
11503050 001	307Y-120	1M	70
11503060 001	307Y-140	1M	70
11503070 001	307Y-160	1M	70
11503080 001	307Y-200	1M	70
11503505 001	308-50	1M	70
11503510 001	308-60	1M	70
11503520 001	308-80	1M	70
11504501 001	310-40	1M	71
11504505 001	310-50	1M	71
11504510 001	310-60	1M	71
11504515 001	310-70	1M	71
11504520 001	310-80	1M	71
11504525 001	310-80S	1M	71
11504530 001	310-90	1M	71
11504535 001	310-90S	1M	71
11504540 001	310-100	1M	71
11504545 001	310-100S	1M	71
11504550 001	310-120	1M	71
11504560 001	310-140	1M	71
11504570 001	310-160	1M	71
11504580 001	310-200	1M	71
11504020 001	309-80	1M	71
11504040 001	309-100	1M	71
11504050 001	309-120	1M	71
11504060 001	309-140	1M	71
11505040 001	315-100	1M	71
11505050 001	315-120	1M	71
11505060 001	315-140	1M	71
11505070 001	315-160	1M	71
11505080 001	315-200	1M	71
11506040 001	320V-100	1M	71
11506050 001	320V-120	1M	71
11506070 001	320V-160	1M	71
11506080 001	320V-200	1M	71
11506090 001	320V-250	1M	71
11505540 001	320U-100	1M	71
11505550 001	320U-120	1M	71
11505570 001	320U-160	1M	71
11505580 001	320U-200	1M	71
11505590 001	320U-250	1M	71
11506240 001	320Y-100	1M	72
11506250 001	320Y-120	1M	72
11506270 001	320Y-160	1M	72
11506280 001	320Y-200	1M	72
11506290 001	320Y-250	1M	72
11507040 001	322V-100	1M	72
11507041 001	322V-100	1M	72
11507050 001	322V-120	1M	72
11507051 001	322V-120	1M	72
11507070 001	322V-160	1M	72

GATE

CODE	ART.	CAT.	PAG.	CODE	ART.	CAT.	PAG.	CODE	ART.	CAT.	PAG.
11507071 001	322V-160	1M	72	11509525 001	327-80S	1M	73	11513060 001	335U-140	1M	75
11507072 001	322V-160	1M	72	11509740 001	328-100	1M	73	11513720 001	335Y-80	1M	75
11507080 001	322V-200	1M	72	11510510 001	330V-60	1M	74	11513730 001	335Y-90	1M	75
11507081 001	322V-200	1M	72	11510515 001	330V-70	1M	74	11513740 001	335Y-100	1M	75
11507082 001	322V-200	1M	72	11510520 001	330V-80	1M	74	11513750 001	335Y-120	1M	75
11507090 001	322V-250	1M	72	11510530 001	330V-90	1M	74	11513760 001	335Y-140	1M	75
11506540 001	322U-100	1M	72	11510540 001	330V-100	1M	74	11514530 001	336V-90	1M	75
11506541 001	322U-100	1M	72	11510550 001	330V-120	1M	74	11514540 001	336V-100	1M	75
11506550 001	322U-120	1M	72	11510560 001	330V-140	1M	74	11514550 001	336V-120	1M	75
11506551 001	322U-120	1M	72	11510010 001	330U-60	1M	74	11514560 001	336V-140	1M	75
11506570 001	322U-160	1M	72	11510015 001	330U-70	1M	74	11514570 001	336V-160	1M	75
11506571 001	322U-160	1M	72	11510020 001	330U-80	1M	74	11514580 001	336V-200	1M	75
11506572 001	322U-160	1M	72	11510030 001	330U-90	1M	74	11514030 001	336U-90	1M	76
11506580 001	322U-200	1M	72	11510040 001	330U-100	1M	74	11514040 001	336U-100	1M	76
11506581 001	322U-200	1M	72	11510050 001	330U-120	1M	74	11514050 001	336U-120	1M	76
11506582 001	322U-200	1M	72	11510060 001	330U-140	1M	74	11514060 001	336U-140	1M	76
11506590 001	322U-250	1M	72	11510710 001	330Y-60	1M	74	11514070 001	336U-160	1M	76
11507240 001	322Y-100	1M	72	11510715 001	330Y-70	1M	74	11514080 001	336U-200	1M	76
11507241 001	322Y-100	1M	72	11510720 001	330Y-80	1M	74	11514730 001	336Y-90	1M	76
11507250 001	322Y-120	1M	72	11510730 001	330Y-90	1M	74	11514740 001	336Y-100	1M	76
11507251 001	322Y-120	1M	72	11510740 001	330Y-100	1M	74	11514750 001	336Y-120	1M	76
11507270 001	322Y-160	1M	72	11510750 001	330Y-120	1M	74	11514760 001	336Y-140	1M	76
11507271 001	322Y-160	1M	72	11510760 001	330Y-140	1M	74	11514770 001	336Y-160	1M	76
11507272 001	322Y-160	1M	72	11511010 001	332-60	1M	74	11514780 001	336Y-200	1M	76
11507280 001	322Y-200	1M	72	11511015 001	332-70	1M	74	11515020 001	337-80	1M	76
11507281 001	322Y-200	1M	72	11511020 001	332-80	1M	74	11515025 001	337-80S	1M	76
11507282 001	322Y-200	1M	72	11511025 001	332-80S	1M	74	11515030 001	337-90	1M	76
11507290 001	322Y-250	1M	72	11511030 001	332-90	1M	74	11515035 001	337-90S	1M	76
11507540 001	323-100	1M	72	11511035 001	332-90S	1M	74	11515040 001	337-100	1M	76
11507550 001	323-120	1M	72	11511040 001	332-100	1M	74	11515045 001	337-100S	1M	76
11507570 001	323-160	1M	72	11511045 001	332-100S	1M	74	11515050 001	337-120	1M	76
11507580 001	323-200	1M	72	11511050 001	332-120	1M	74	11515060 001	337-140	1M	76
11507590 001	323-250	1M	72	11511060 001	332-140	1M	74	11515530 001	338-90	1M	76
11508040 001	324-100	1M	72	11512040 001	333V-100	1M	74	11515540 001	338-100	1M	76
11508041 001	324-100	1M	72	11512050 001	333V-120	1M	74	11515550 001	338-120	1M	76
11508050 001	324-120	1M	72	11512060 001	333V-140	1M	74	11515560 001	338-140	1M	76
11508051 001	324-120	1M	72	11511540 001	333U-100	1M	74	11515570 001	338-160	1M	76
11508070 001	324-160	1M	72	11511550 001	333U-120	1M	74	11515580 001	338-200	1M	76
11508071 001	324-160	1M	72	11511560 001	333U-140	1M	74	11515621 001	339V-120	1M	76
11508072 001	324-160	1M	72	11512240 001	333Y-100	1M	75	11515622 001	339V-160	1M	76
11508080 001	324-200	1M	72	11512250 001	333Y-120	1M	75	11515611 001	339U-120	1M	76
11508081 001	324-200	1M	72	11512260 001	333Y-140	1M	75	11515612 001	339U-160	1M	76
11508082 001	324-200	1M	72	11512540 001	334-100	1M	75	11515641 001	339-120	1M	77
11508090 001	324-250	1M	72	11512550 001	334-120	1M	75	11515642 001	339-160	1M	77
11509010 001	325V-60	1M	73	11512560 001	334-140	1M	75	19907301 001	339-250	1M	77
11509020 001	325V-80	1M	73	11513520 001	335V-80	1M	75	11516010 001	340-60	1M	77
11909030 001	325V-90	1M	73	11513530 001	335V-90	1M	75	11516020 001	340-80	1M	77
11909040 001	325V-100	1M	73	11513540 001	335V-100	1M	75	11516040 001	340-100	1M	77
11508510 001	325U-60	1M	73	11513550 001	335V-120	1M	75	11516050 001	340-120	1M	77
11508520 001	325U-80	1M	73	11513560 001	335V-140	1M	75	11517020	342-80	1M	77
11509240 001	326V-100	1M	73	11513020 001	335U-80	1M	75	11517030	342-90	1M	77
11508740 001	326U-100	1M	73	11513030 001	335U-90	1M	75	11517040	342-100	1M	77
11509510 001	327-60	1M	73	11513040 001	335U-100	1M	75	12400503 001	400-9	1E	77
11509520 001	327-80	1M	73	11513050 001	335U-120	1M	75	12400504 001	400-10	1E	77



CODE	ART.	CAT.	PAG.
12400505 001	400-11	1E	77
12400510 001	400-12	1E	77
12400515 001	400-14	1E	77
12400520 001	400-16,5	1E	77
12400525 001	400-20	1E	77
15400712 001	401S-12	1E	77
15400714 001	401S-14	1E	77
15400720 001	401S-20	1E	77
15400506 001	401Z-6	1E	77
15400508 001	401Z-8	1E	77
15400509 001	401Z-9	1E	77
15400510 001	401Z-10	1E	77
15400511 001	401Z-11	1E	77
15400512 001	401Z-12	1E	77
15400514 001	401Z-14	1E	77
11604006	402-60	1E	78
11604008	402-80	1E	78
11604010	402-100	1E	78
11604012	402-120	1E	78
11604014	402-140	1E	78
11604006 001	402Z-60	1E	78
11604008 001	402Z-80	1E	78
11604010 001	402Z-100	1E	78
11604012 001	402Z-120	1E	78
11604014 001	402Z-140	1E	78
11604514	405-140	1E	78
11604517	405-170	1E	78
11604520	405-200	1E	78
11604514 001	405Z-140	1E	78
11604517 001	405Z-170	1E	78
11604520 001	405Z-200	1E	78
11605008	410-80	1E	78
11605010	410-100	1E	78
11605012	410-120	1E	78
11605014	410-140	1E	78
11605008 001	410Z-80	1E	78
11605010 001	410Z-100	1E	78
11605012 001	410Z-120	1E	78
11605014 001	410Z-140	1E	78
11607514	411-170	1E	79
11605514	415-140	1E	79
11605517	415-170	1E	79
11605520	415-200	1E	79
11605514 001	415Z-140	1E	79
11605517 001	415Z-170	1E	79
11605520 001	415Z-200	1E	79
11606006	420-60	1E	79
11606008	420-80	1E	79
11606010	420-100	1E	79
11606012	420-120	1E	79
11606014	420-140	1E	79
11606514	425-140	1E	79
11606517	425-170	1E	79
11606520	425-200	1E	79

CODE	ART.	CAT.	PAG.
11606614	425PS-140	1E	80
11606617	425PS-170	1E	80
11607006	430DX-60	1E	80
11607008	430DX-80	1E	80
11607010	430DX-100	1E	80
11607012	430DX-120	1E	80
11607014	430DX-140	1E	80
11607017	430DX-170	1E	80
11607020	430DX-200	1E	80
11607106	430SX-60	1E	80
11607108	430SX-80	1E	80
11607110	430SX-100	1E	80
11607112	430SX-120	1E	80
11607114	430SX-140	1E	80
11607117	430SX-170	1E	80
11607120	430SX-200	1E	80
11607308	431-80	1E	80
11607338	431-80-SP3	1E	80
11607310	431-100	1E	80
11607311	431-110	1E	80
11607312	431-120	1E	80
11607509	440-90	1E	80
11698010	435 - 30x30	1E	81
11697010	435 - 40x30	1E	81
11698020	436 - 30x30	1E	81
11697020	436 - 40x30	1E	81
11698030	437 - 30x30	1E	81
11697030	437 - 40x30	1E	81
11608009	445-90	1E	82
11608509	450-90	1E	82
11609009	455-90	1E	82
11609518	456-180	1E	82
11610018	457-180	1E	82
11610518	458-180	1E	82
11611018	459-180	1E	83
11611518	460-180	1E	83
11612018	465-180	1E	83
11612518	470-180	1E	83
11613018	475-180	1E	83
11613518	480-180	1E	83
11614018	482-180	1E	84
11614518	485-180	1E	84
11615018	487-180	1E	84
11647010	490-100	1E	84
11647012	490-120	1E	84
11647014	490-140	1E	84
11647110	492-100	1E	84
11647112	492-120	1E	84
11647114	492-140	1E	84
11647210	494-100	1E	84
11647215	494-150	1E	84
11647310	495-100	1E	85
11647315	495-150	1E	85
19912001	495PS-100	1E	85

CODE	ART.	CAT.	PAG.
19912005	495PS-150	1E	85
11615910	495T-100	1E	85
11615915	495T-150	1E	85
11647410	496-100	1E	85
11647415	496-150	1E	85
11617610	496T-100	1E	85
11617615	496T-150	1E	85
11648010	497-100	1E	85
11648015	497-150	1E	85
19912240	497PS-100	1E	85
19912245	497PS-150	1E	85
11615810	497T-100	1E	85
11615810 001	497T-100	1E	85
11615815	497T-150	1E	85
11648010 001	497Z-100	1E	85
11648015 001	497Z-150	1E	85
11648110	498-100	1E	85
11648115	498-150	1E	85
11616710	498T-100	1E	85
11616715 001	498T-150	1E	85
11648110 001	498Z-100	1E	85
11648115 001	498Z-150	1E	85
11618515	500-150	1E	85
11619015	505-150	1E	86
11619515	510-150	1E	86
11620015	515-150	1E	86
11620515	520-150	1E	86
11621015	525-150	1E	86
11621515	530-150	1E	86
11621615	540DX	1E	87
11621605	540SX	1E	87
11621620	541DX	1E	87
11621610	541SX	1E	87
11621705	542-70	1E	87
11621710	543-70	1E	87
11621805	544	1E	87
11601010	545-C	1E	87
11601015	545-CS	1E	87
11601005	545-O	1E	87
12100910	546-C	1E	88
12100915	546-CS	1E	88
12100905	546-O	1E	88
12100955	547-DX-B	1E	88
12100950	547-DX-M	1E	88
12100965	547-SX-B	1E	88
12100960	547-SX-M	1E	88
12100985	548-25,5-B	1E	88
12100980	548-25,5-M	1E	88
12100975	548-27,5-B	1E	88
12100970	548-27,5-M	1E	88
11622030	550-300	1E	88
11622530	551-300	1E	88
11623030	552-300	1E	88

GATE

CODE	ART.	CAT.	PAG.	CODE	ART.	CAT.	PAG.	CODE	ART.	CAT.	PAG.
11647610	560-100	1E	89	11805005 001	607-35	1G	91	11901120 005	703-250	1D	96
11647612	560-120	1E	89	11805020 001	608-30	1G	91	11901115 005	703-300	1D	96
11647614	560-140	1E	89	11805015 001	608-35	1G	91	11901105 017	703-150	1D	96
11628516	560-160	1E	89	11805030 001	609-30	1G	91	11901110 017	703-200	1D	96
11628518	560-180	1E	89	11805025 001	609-35	1G	91	11901120 017	703-250	1D	96
11647608	560-80	1E	89	12207505 001	615-10	1G	91	11901115 017	703-300	1D	96
11628510	560T-100	1E	89	12207510 001	615-12	1G	91	11901206 001	704-16	1D	97
11628512	560T-120	1E	89	11700505 001	620	1G	91	11901211 001	704-20	1D	97
11628514	560T-140	1E	89	11701005 001	625	1G	91	11901216 001	704-24	1D	97
11628506	560T-60	1E	89	11701010 001	625	1G	91	11901215 001	704-24	1D	97
11628506 001	560T-60	1E	89	11701105 001	627P	1G	92	11901605 001	705-16	1D	97
11647608 001	560Z-80	1E	89	11701110 001	627G	1G	92	11901610 001	705-20	1D	97
11647710	564-100	1E	89	11701205	628	1G	92	11901615 001	705-24	1D	97
11647712	564-120	1E	89	11701505 001	630	1G	92	11901805 001	706	1D	97
11647714	564-140	1E	89	11702005	635	1G	92	11901905 001	707	1D	97
11615916	564-160	1E	89	11702505	640	1G	92	11901705 001	708	1D	97
11615918	564-180	1E	89	11703005	645	1G	92	11902005 001	710-130	1D	97
11615911	564T-100	1E	89	11703505	650	1G	93	11902010 001	710-300	1D	97
11615912	564T-120	1E	89	11704005	655	1G	93	11902015 001	710-500	1D	97
11615914	564T-140	1E	89	10904005 001	660DX	1H	93	11902505 001	712-130	1D	98
11615604	570-40	1E	89	10904010 001	660SX	1H	93	11902510 001	712-300	1D	98
11615606	570-60	1E	89	10904505 001	662	1H	93	11902515 001	712-500	1D	98
11615608	570-80	1E	89	11801005 001	670	1H	93	11903005 001	714-330	1D	98
11615610	570-100	1E	89	11000400 001	671P	1H	94	11903010 001	714-660	1D	98
11615612	570-120	1E	89	11000401 503	671G	1H	94	11903505 001	716-330	1D	98
11615614	570-140	1E	89	11000300 503	672P	1H	94	11903510 001	716-660	1D	98
11616104	572-40	1E	89	11000301 503	672G	1H	94	11903905 001	719	1D	98
11616106	572-60	1E	89	11900505 001	673	1H	94	11904005 001	720-350	1D	98
11616108	572-80	1E	89	10905006 503	674	1H	94	11904010 001	720-450	1D	98
11616110	572-100	1E	89	11000505 503	675P	1H	94	11904015 001	720-600	1D	98
11616112	572-120	1E	89	11000510 503	675G	1H	94	11904020 001	720-800	1D	98
11616114	572-140	1E	89	11001005 503	677P	1H	94	11904505 001	725-450	1D	98
11617110	574-100	1E	89	11001010 503	677G	1H	94	11904510 001	725-600	1D	98
11617115	574-150	1E	89	11001505 503	678P	1H	94	11904515 001	725-800	1D	98
11617210	575-100	1E	89	11001510 503	678G	1H	94	11904705 001	732Z	1D	99
11617215	575-150	1E	89	11002505 503	679P	1H	95	11905005 001	735-150	1D	99
11617310	576-100	1E	90	11002510 503	679G	1H	95	11905010 001	735-200	1D	99
11617314	576-140	1E	90	11203005 001	680	1B	95	11905015 001	735-250	1D	99
11617315	576-150	1E	90	11203505 001	682	1B	95	11905020 001	735-300	1D	99
11648310	577-100	1E	90	10205505 001	683	1B	95	11905025 001	735-400	1D	99
11648314	577-140	1E	90	10205510 001	683	1B	95	11905030 001	735-500	1D	99
11648315	577-150	1E	90	11204005 700	684	1B	95	11905035 001	735-600	1D	99
11648410	578-100	1E	90	11204805 503	685	1B	95	11905040 001	735-800	1D	99
11648414	578-140	1E	90	11204705 503	686	1B	96	11905205 001	737-150	1D	99
11648415	578-150	1E	90	10206005 001	687	1B	96	11905210 001	737-200	1D	99
10703005 001	590	1G	90	10206010 001	687	1B	96	11905215 001	737-250	1D	99
10703015 001	591-16	1G	90	10206510 001	688	1D	96	11905220 001	737-300	1D	99
10703020 001	591-18	1G	90	10206515 001	689-8	1D	96	11905225 001	737-400	1D	99
10703025 001	591-20	1G	90	10206520 001	689-10	1D	96	11905230 001	737-500	1D	99
11623505	600-65	1G	90	10206525 001	689-12	1D	96	11905235 001	737-600	1D	99
11623510	600-85	1G	90	10206530 001	689-14	1D	96	11905240 001	737-800	1D	99
11624005	606-65	1G	90	11901005 001	700Z	1D	96	11905505 001	740-150	1D	99
11624010	606-85	1G	90	11901105 005	703-150	1D	96	11905510 001	740-200	1D	99
11805010 001	607-30	1G	91	11901110 005	703-200	1D	96	11905515 001	740-250	1D	99

GATE



CODE	ART.	CAT.	PAG.
11905520 001	740-300	1D	99
11905525 001	740-400	1D	99
11905530 001	740-500	1D	99
11905535 001	740-600	1D	99
11905540 001	740-800	1D	99
11906005 001	745-200	1D	99
11906010 001	745-250	1D	99
11906015 001	745-300	1D	99
11906020 001	745-400	1D	99
11906025 001	745-500	1D	99
11906030 001	745-600	1D	99
11906035 001	745-800	1D	99
11906500 001	750-100	1D	99
11906505 002	750-150	1D	99
11906510 002	750-200	1D	99
11906705 005	752-130	1D	100
11906710 005	752-145	1D	100
11906715 005	752-170	1D	100
11906720 005	752-195	1D	100
11907005 002	755-200	1D	100
11907010 002	755-300	1D	100
11907015 002	755-400	1D	100
11907020 002	755-500	1D	100
11907505 002	760-180	1D	100
11907510 002	760-215	1D	100
11907515 002	760-270	1D	100
11908005 002	800-200	1D	100
11908010 002	800-250	1D	100
11908015 002	800-300	1D	100
11908020 002	800-400	1D	100
11908025 002	800-500	1D	100
11908030 002	800-600	1D	100
11908035 002	800-800	1D	100
11908505 005	805-80	1D	100
11908510 005	805-120	1D	100
11908515 005	805-160	1D	100
11908520 005	805-200	1D	100
11909005 005	810-150	1D	100
11909010 005	810-200	1D	100
11909015 005	810-250	1D	100
11909020 005	810-300	1D	100
11909025 005	810-400	1D	100
11909505 005	820-200	1D	101
11909510 005	820-300	1D	101
11909515 005	820-400	1D	101
11909520 005	820-500	1D	101
11910005 005	825-150	1D	101
11910010 005	825-200	1D	101
11910015 005	825-250	1D	101
11910020 005	825-300	1D	101
11910025 005	825-400	1D	101
11910030 005	825-500	1D	101
11910035 005	825-600	1D	101
11910040 005	825-800	1D	101

CODE	ART.	CAT.	PAG.
12002005 005	827	1D	101
11910505 005	835-200	1D	101
11910510 005	835-300	1D	101
11910515 005	835-400	1D	101
11910520 005	835-500	1D	101
11910525 005	835-600	1D	101
11910530 005	835-800	1D	101
12002505 005	837	1D	101
11911005 002	840-200	1D	101
11911010 002	840-300	1D	101
11911015 002	840-400	1D	101
11911020 002	840-500	1D	101
11911025 002	840-600	1D	101
11911035 002	840-800	1D	101
11911045 002	840-1000	1D	101
11911505 002	840D-200	1D	102
11911510 002	840D-300	1D	102
11911515 002	840D-400	1D	102
11911520 002	840D-500	1D	102
11911525 002	840D-600	1D	102
11911535 002	840D-800	1D	102
11911545 002	840D-1000	1D	102
12003005 002	852	1D	102
12003505 001	855	1D	102
12004005 001	857	1D	102
11913001 001	860	1D	102
11914001 001	862-240	1D	102
11914005 001	862-560	1D	102
11914010 001	862-560-e20	1D	102
15700005 503	865-05	1D	103
15700010 503	866-10	1D	103
15700015 503	867-05	1D	103
15700020 503	868-05	1D	103
15700025 503	868-15	1D	103
15700030 503	869-05	1D	103
15700035 503	869-15	1D	103
15700040 503	871-05	1D	103
15700045 503	871-10	1D	103
15700050 503	873-05	1D	104
15700055 503	873-10	1D	104
15700060 503	874-05	1D	104
15700065 503	875-05	1D	104
15700070 503	875-10	1D	104
15700075 503	876-05	1D	104
15700080 503	876-10	1D	104
15700085 503	877	1D	104
15700090 503	877S	1D	104
15800005	878-06	1G	105
15800010	878-08	1G	105
15800015	878-10	1G	105
15800020	878-12	1G	105
15800025	878-14	1G	105
15800030	878-16	1G	105
15800035	878-18	1G	105
15800040	878-20	1G	105

CODE	ART.	CAT.	PAG.
15800045	878-22	1G	105
15800505	879-06	1G	105
15800510	879-08	1G	105
15800515	879-10	1G	105
15800520	879-12	1G	105
15800525	879-14	1G	105
15800530	879-16	1G	105
15800535	879-18	1G	105
15800540	879-20	1G	105
15800545	879-22	1G	105

CANTILEVER COMPONENTS

CODE	ART.	CAT.	PAG.
10130030 001	CGS-250.5M	1Q	108
10130031 001	CGS-250.5P	1Q	108
10130032 001	CGS-250.5G	1Q	108
10207004	CGS-245M	1R	109
10207024	CGS-245M	1R	109
10207006	CGS-245P	1R	109
10207025	CGS-245P	1R	109
10207015	CGS245-P	1R	109
10207014	CGS-245G	1R	109
10207026	CGS-245G	1R	109
10207004 001	CGS-245M	1R	109
10207024 001	CGS-245M	1R	109
10207006 001	CGS-245P	1R	109
10207025 001	CGS-245P	1R	109
10207015 001	CGS245-P	1R	109
10207014 001	CGS-245G	1R	109
10207026 001	CGS-245G	1R	109
10130001 001	CGS-350.5M	1Q	110
10130005 001	CGS-350.5P	1Q	110
10130010 001	CGS-350.5G	1Q	110
10207001	CGS-345M	1R	111
10207002	CGS-345M	1R	111
10207005	CGS-345P	1R	111
10207007	CGS-345P	1R	111
10207010	CGS345-P	1R	111
10207020	CGS-345G	1R	111
10207022	CGS-345G	1R	111
10207001 001	CGS-345M	1R	111
10207002 001	CGS-345M	1R	111
10207005 001	CGS-345P	1R	111
10207007 001	CGS-345P	1R	111
10207010 001	CGS345-P	1R	111
10207020 001	CGS-345G	1R	111
10207022 001	CGS-345G	1R	111
10130043 001	CGS350.5XL	1Q	112
10207032	CGS345-XL	1Q	113
10130600 001	CGA-350.5M	1Q	114
10130605 001	CGA-350.5P	1Q	114
10208001	CGA-345M	1R	115
10208003	CGA-345M	1R	115
10208005 001	CGA-345P	1R	115
10208007 001	CGA-345P	1R	115
10130003 001	CGS-250.8M	1Q	116
10130007 001	CGS-250.8P	1Q	116
10130012 001	CGS-250.8G	1Q	116
10130002 001	CGS-350.8M	1Q	117
10130006 001	CGS-350.8P	1Q	117
10130011 001	CGS-350.8G	1Q	117
10131005 001	CG-05P	1T	120
10131010 001	CG-05G	1T	120
10131100 001	CG-10	1T	120
10708001 001	CG-15M	1T	120
10708005 001	CG-15P	1T	120
10708010 001	CG-15G	1T	120

CODE	ART.	CAT.	PAG.
10707101 001	CG-20M	1T	120
10707105 001	CG-20P	1T	120
10707110 001	CG-20G	1T	120
10707135 001	CG-20XL	1T	120
10707001 001	CGA-20M	1T	120
10707005 001	CGA-20P	1T	120
10707125 001	CG-21 G	1T	120
10707115 001	CG-21 M	1T	120
10707120 001	CG-21 P	1T	120
10707005 001	CG-25M	1T	121
10707501 001	CG-25P	1T	121
10707505 001	CG-25G	1T	121
10707510 001	CG-30M	1S	121
10707605 001	CG-30P	1S	121
10707610 001	CG-30G	1S	121
10707705 001	CG-35P	1T	121
10707710 001	CG-35G	1T	121
10131400 001	CG-40	1T	121
11310005 001	CG-251	1S	121
11310100 001	CG-252	1S	121
10210150 001	CG-254	1S	122
11310300 001	CG-256-40	1S	122
11310301 001	CG-256-50	1S	122
10130505 001	CG-348	1T	122
10130510 001	CG-348	1T	122
10705200 001	CGA-347M	1T	122
10705205 001	CGA-347P	1T	122
10705501 001	CGS-346M	1T	122
10705505 001	CGS-346P	1T	122
10705510 001	CGS-346G	1T	122
10705515 001	CGS-346 XL	1T	122
10705001 001	CGS-347M	1T	122
10705005 001	CGS-347P	1T	122
10705010 001	CGS-347G	1T	122
10705015 001	CGS-347 XL	1T	122
19912326	KIT150-300B3M	1U	124
19912333	KIT150-300B6M	1U	124
19912330	KIT150-300T3M	1U	124
19912331	KIT150-300T6M	1U	124
19912324	KIT150-600B3M	1U	124
19912334	KIT150-600B6M	1U	124
19912325	KIT150-600 T3M	1U	124
19912332	KIT150-600T6M	1U	124
19912494	KITCGA150-300	1U	125
19912495	KITCGA150-600	1U	125

INOX COMPONENTS



CODE	ART.	CAT.	PAG.
10800305	84i	2A	130
10800605	86i-P	2A	130
10800610	86i-G	2A	130
10801105	87i-P	2A	130
10801110	87i-G	2A	130
10806205	116i-20	2A	130
10806210	116i-24	2A	130
10806605	120i-M20	2A	130
10806610	120i-M24	2A	130
12100705	165i-30	2G	130
12100710	165i-40	2G	130
12100715	165i-50	2G	130
12100720	165i-60	2G	130
12100725	165i-80	2G	130
12100730	165i-100	2G	130
12100735	165i-120	2G	130
12100740	165i-150	2G	130
10701520	195i-400	2G	131
10701530	195i-500	2G	131
10701540	195i-600	2L	131
10701550	195i-700	2L	131
10200108	197i	2L	131
10701105	170i	2G	131
10701610	200i-G	2G	131
11301310	230i-30	2L	131
11301315	230i-40	2L	131
11305605	250i-220	2L	131
11306105	255i-220	2L	132
11401105	262i-30x12	2F	132
11401905	264i	2F	132
10902505	270i-P	2H	132
10902510	270i-G	2H	132
10204113	287i-Go19-SP2	2I	132
10204114	287i-Go19-SP2	2I	132
10201605	289i-Go19-SP2	2I	132
10201610	289i-Go19-SP2	2I	132
10602105	291i	2I	133
10201805	293i	2I	133
10201810	293i	2I	133
10602305	295i	2I	133
10601705	297i	2I	133
11501410	300i-V60	2M	133
11501420	300i-V80	2M	133
11501430	300i-V90	2M	133
11501440	300i-V100	2M	133
11501450	300i-V120	2M	133
11501460	300i-V140	2M	133
11501470	300i-V160	2M	133
11501480	300i-V200	2M	133
11502140	305i-V100	2M	133
11502150	305i-V120	2M	133
11502160	305i-V140	2M	133
11502170	305i-V160	2M	133
11502180	305i-V200	2M	133

CODE	ART.	CAT.	PAG.
11504810	310i-60	2M	134
11504825	310i-80S	2M	134
11504835	310i-90S	2M	134
11504845	310i-100S	2M	134
11504850	310i-120	2M	134
11504860	310i-140	2M	134
11504870	310i-160	2M	134
11504880	310i-200	2M	134
11505140	315i-100	2M	134
11505150	315i-120	2M	134
11505160	315i-140	2M	134
11505170	315i-160	2M	134
11505180	315i-200	2M	134
11513630	335i-V90	2M	134
11513640	335i-V100	2M	134
11513650	335i-V120	2M	134
11514630	336i-90V	2M	134
11514640	336i-100V	2M	134
11514650	336i-120V	2M	134
11515130	337i-90S	2M	134
11515140	337i-100S	2M	134
11515150	337i-120	2M	134
11515630	338i-90	2M	134
11515640	338i-100	2M	134
11515650	338i-120	2M	134
15400606	401i-6	2E	135
15400608	401i-8	2E	135
15400609	401i-9	2E	135
15400610	401i-10	2E	135
15400611	401i-11	2E	135
15400612	401i-12	2E	135
15400614	401i-14	2E	135
11604206	402i-60	2E	135
11604208	402i-80	2E	135
11604210	402i-100	2E	135
11604212	402i-120	2E	135
11604214	402i-140	2E	135
11604614	405i-140	2E	135
11604617	405i-170	2E	135
11604620	405i-200	2E	135
11605208	410i-80	2E	135
11605210	410i-100	2E	135
11605212	410i-120	2E	135
11605214	410i-140	2E	135
11605614	415i-140	2E	135
11605617	415i-170	2E	135
11605620	415i-200	2E	135
11606106	420-60i	2E	135
11606108	420-80i	2E	135
11606110	420-100i	2E	135
11606112	420-120i	2E	135
11606114	420-140i	2E	135
11606417	425-170i	2E	136
11606420	425-200i	2E	136

CODE	ART.	CAT.	PAG.
11607709	440i-90	2E	136
11608609	450i-90	2E	136
11609618	456i-180	2E	136
11610618	458i-180	2E	136
11611618	460i-180	2E	136
11612618	470i-180	2E	137
11613618	480i-180	2E	137
11614618	485i-180	2E	137
11618615	500i-150	2E	137
11700595	620i	2G	137
11002610	679i	2H	137
11912001	730i	2D	138
11904705	732i	2D	138
10131305	CGI-05P	1T	138
11310305	CGI-251	1S	138
10706005	CGI-346P	1T	138
10705305	CGI-347P	1T	138
10130705	CGI-348	1T	138
10130305	CGI-350.5P	1Q	139
10207505	CGI-345P	1R	139
10207507	CGI-345P	1R	139

**INDUSTRIAL DOORS**

CODE	ART.	CAT.	PAG.	CODE	ART.	CAT.	PAG.	CODE	ART.	CAT.	PAG.
10700405	239	3E	142	11000400 503	671 P	3A	148	11003500	699	3F	150
10701705 001	246	3G	142	11000401 503	671 G	3A	148	11630405 503	A370P	3D	150
11307500 001	248-60	3H	142	11205006 503	690 MC DX	3A	148	11630905 503	A371P	3D	150
11307501 001	248-70	3H	142	11205006 001	690 MC DX	3A	148	11630505 503	A380P	3D	150
11307505 001	248-80	3H	142	11205011 503	690 MC SX	3A	148	11630511 503	A380G	3D	150
10401505 001	249-30	3E	142	11205011 001	690 MC SX	3A	148	11634005 503	A380R	3D	151
10902005 001	270P	1H	142	12001105 503	691P	3A	148	11631005 503	A381P	3D	151
10902010 001	270G	1H	142	12001105 001	691P	3A	148	11631011 503	A381G	3D	151
10903005 001	272	1H	142	12001505 503	691G	3E	148	11632405 503	A384P	3D	151
10603006 001	354-185	3G	143	12001505 001	691G	3E	148	11632505 503	A385P	3D	151
10603011 001	354-330	3G	143	10203503 003	692 P-1200	3A	148	11644015 503	P365	3D	152
10603007 001	355P	3G	143	10203503 001	692 P-1200	3A	148	11645515 503	P365 R	3D	152
10603012 001	355G	3G	143	10203515 003	692 P-3000	3A	148	11644500 503	P368 I	3D	152
10603013 001	355S	3G	143	10203515 001	692 P-3000	3A	148	11644550 503	P368 S	3D	152
10604005 001	356P	3G	143	10203504 003	692 P-4800	3A	148	11644560 503	P368 M	3D	152
10202010 001	358	3G	143	10203504 001	692 P-4800	3A	148	11640710 503	P370	3D	152
10702505	361P	3E	144	10203518 003	692 G-1200	3A	148	11641210 503	P371	3D	153
10702510	361G	3E	144	10203518 001	692 G-1200	3A	148	11640510 503	P380	3D	153
10702611	362	3E	144	10203530 003	692 G-3000	3A	148	11641010 503	P381	3D	153
10702405	363	1G	144	10203530 001	692 G-3000	3A	148	11642510 503	P385	3D	153
10702905	364	3E	144	10203540 003	692 G-4800	3A	148	10310701	R383-33	3E	153
10702905 001	365	3E	144	10203540 001	692 G-4800	3A	148	10310702	R383-13.5	3E	153
10702105	365 AL	3E	144	11207006 503	693 MC DX	3A	148	10310601 001	R378	3E	154
10702220	366-42	3E	144	11207011 503	693 MC SX	3A	148	12400526 003	400	1E	154
10702305	367	3E	145	11205506 503	694 MC DX	3A	149				
10113007 001	375 P16	3B	145	11205506 001	694 MC DX	3A	149				
10113006 001	375 P20	3B	145	11205511 503	694 MC SX	3A	149				
10113010 001	375 G	3B	145	11205511 001	694 MC SX	3A	149				
10113402 001	376 P16	3B	145	10203703 003	695 P-1200	3A	149				
10113401 001	376 P20	3B	145	10203703 001	695 P-1200	3A	149				
10118550 001	377P	3E	145	10203715 003	695 P-3000	3A	149				
10118535 001	377 G/290	3E	145	10203715 001	695 P-3000	3A	149				
10118535 003	377 G/290	3E	145	10203704 003	695 P-4800	3A	149				
10118540 001	377 G/330	3E	145	10203704 001	695 P-4800	3A	149				
10118540 003	377 G/330	3E	145	10203718 003	695 G-1200	3A	149				
10118530 001	377R-330	3E	146	10203718 001	695 G-1200	3A	149				
10118530 002	377R-330	3E	146	10203730 003	695 G-3000	3A	149				
10118530 003	377R-330	3E	146	10203730 001	695 G-3000	3A	149				
10118701 001	377G-SC	3E	146	10203740 003	695 G-4800	3A	149				
10310505 001	378P	3E	146	10203740 001	695 G-4800	3A	149				
10310510 001	378G	3E	146	10203702 003	695 PM-1200	3A	149				
10311005 001	379P	3E	146	10203702 001	695 PM-1200	3A	149				
10311008 001	379G-135	3E	146	10203701 003	695 GM-1200	3A	149				
10311008 003	379G-135	3E	146	10203701 001	695 GM-1200	3A	149				
10311010 001	379G-200	3E	146	11206006 503	696 MC DX	3A	149				
10311010 003	379G-200	3E	146	11206006 001	696 MC DX	3A	149				
10210101 503	387	3G	146	11206011 503	696 MC SX	3A	149				
10210010 503	388	3G	146	11206011 001	696 MC SX	3A	149				
10118350 503	395DX	3B	147	11206506 503	698 MC DX-50	3A	150				
10118360 503	395SX	3B	147	11206506 001	698 MC DX-50	3A	150				
10118305 503	396	3B	147	11206526 503	698 MC DX-80	3A	150				
10203011 001	398	3G	147	11206526 001	698 MC DX-80	3A	150				
10203012 001	398	3G	147	11206511 503	698 MC SX-50	3A	150				
10203006 001	399	3G	147	11206511 001	698 MC SX-50	3A	150				
10203008 001	399	3G	147	11206531 503	698 MC SX-80	3A	150				
10203007 001	399	3G	147	11206531 001	698 MC SX-80	3A	150				

FRAME

CODE	ART.	CAT.	PAG.
12200505 001	900-28	5C	158
12200510 001	900-36	5C	158
12201005 001	960-36	5C	158
12201510 001	1000-40	5C	158
12201515 001	1000-45	5C	158
12202005 001	1001-36	5C	158
12202105 001	1020	5C	159
12203305 001	1051 STYING	5C	159
12203405 001	1052 STYING	5C	159
12203605 001	1053 STYING	5C	159
12235505	1073F-7,5	5G	159
12208505	1102-10,5	5G	159
12231505	1103F	5G	160
12231510	1103F - 7,5	5G	160
12210040	1105-40X18	5G	160
12210020	1105-45X20	5G	160
12210025	1105-45X30	5G	160
12210030	1105-50X20	5G	160
12210035	1105-50X25	5G	160
12210015	1105-GR9 40x20	5G	160
12210010	1105F 40x18	5G	160
12210031	1105F 50x20	5G	160
12210505	1106	5G	160
12211005	1107	5G	160
12211505	1108	5G	160
12211605	1108F	5G	161
12211705	1109F-8,5	5G	161
12212005	1110	5G	161
12212505	1111	5G	161
12213005	1112	5G	161
12214005	1114F-8,5	5G	161
12214505	1115F-8,5	5G	162
12215005	1116F	5G	162
12215505	1117	5G	162
12216005	1118F	5G	162
12216505	1119F	5G	162
12217005	1120	5G	162
12234005	1120F	5G	163
12217505	1121	5G	163
12218005	1122F	5G	163
12236005	1123F-7,5	5G	163
12239505	1124	5G	163
12218505	1125	5G	163
12218705	1125F	5G	164
12241505	1126F-8,5	5G	164
12219005	1127	5G	164
12219505	1128	5G	164
12241005	1129F	5G	164
12220005	1130	5G	164
12220010	1130 - 7,5	5G	164
12220505	1130V	5G	165
12211105	1131F	5G	165
12237005	1132	5G	165
12234505	1133F-7,5	5G	165

CODE	ART.	CAT.	PAG.
12237505	1134F	5G	165
12220805	1135F	5G	165
12221005	1136F	5G	166
12221010	1136F - 7,5	5G	166
12221205	1137	5G	166
12221405	1138F	5G	166
12221605	1139-7,5	5G	166
12221505	1140	5G	166
12221705	1141	5G	166
12238005	1142F	5G	167
12221805	1143F	5G	167
12221905	1144	5G	167
12222005	1145F	5G	167
12222105	1146	5G	167
12222305	1147	5G	167
12254005	1148F PESANTE	5G	168
12254010	1148F LEGGERA	5G	168
12222505	1148 PESANTE	5G	168
12223505	1155	5G	168
12223605	1155F	5G	168
12241605	1156-7,5	5G	168
12232505	1157	5G	168
12233005	1159	5G	169
12224005	1160F TA	5G	169
12224505	1161F	5G	169
12225005	1163F	5G	169
12225505	1164F	5G	169
12225515	1164F - 7,5	5G	169
12226005	1165F	5G	169
12240005	1166	5G	170
12226505	1167	5G	170
12226505	1167	5G	170
12226510	1167F - 7,5	5G	170
12226507	1167F - 7,5 - 9,5	5G	170
12227005	1168F	5G	170
12227505	1169	5G	170
12228005	1170F	5G	170
12240505	1172	5G	171
12241205	1173F-7,5	5G	171
12241205	1173F-9,5	5G	171
12242005	1175	5G	171
12242505	1176	5G	171
12242605	1177F DX-SX	5G	171
12242805	1178F	5G	171
12243505	1179F	5G	172
12233605	1180	5G	172
12233505	1180F	5G	172
12243005	1181F	5G	172
12244005	1182	5G	172
12246001	1182 - 7,5 - 9,5	5G	172
12244505	1183	5G	172
12245005	1184	5G	173
12245505	1186	5G	173
12245602	1187F-7,5	5G	173

CODE	ART.	CAT.	PAG.
12232005	1190F	5G	173
12239005	1191	5G	173
12238505	1192-7,5	5G	173
12238705	1193F	5G	174
12222405	1194F	5G	174
12209005	1196	5G	174
12265505	1197	5G	174
12275505	1198F	5G	174
12236505	1199F	5G	174
12239006	1301 DX	5G	175
12239007	1301 SX	5G	175
12239004	1302	5G	175
12239001	1303	5G	175
12239002	1303-7,5	5G	175
12239003	1304-7,5	5G	175
12229005	1305F (A536F)	5G	175
12229505	1306 (A537)	5G	175
12230005	1307 (A538)	5G	176
12239008	1308	5G	176
12239009	1309	5G	176
12270900	1580	5G	177
12270911	1581	5G	177
12270902	1582	5G	177
12270903	1583	5G	178
12270904	1584	5G	178
12270905	1585	5G	178
12270906	1586	5G	179
12270907	1587	5G	179
12270908	1588	5G	179
12270912	1589	5G	180
12270910	1590	5G	180
12270919	1592	5G	180
12270913	1593	5G	181
12270914	1594	5G	181
12270915	1595	5G	181
12270916	1596	5G	182
12270917	1597	5G	182
12270918	1598	5G	182
12201307	1807	5G	183
12201308	1808	5G	183
12201309	1809	5G	183
12201311	1811	5G	183
12201312	1812	5G	183
12201313	1813	5G	183
12201314	1814	5G	183
12201315	1815	5G	183
12201316	1816	5G	183
12201317	1817	5G	183
12201318	1818	5G	183
12201319	1819	5G	183
12201320	1820	5G	183
12201321	1821	5G	183
12201322	1822	5G	183
12201323	1823	5G	183

FRAME

CODE	ART.	CAT.	PAG.
12201324	1824	5G	183
12201325	1825	5G	183
12201326	1826	5G	183
12201327	1827	5G	183
12201328	1828	5G	183
12201329	1829	5G	183
12201330	1830	5G	183
12201331	1831	5G	183
12201332	1832	5G	183
12201333	1833	5G	183
12201334	1834	5G	183
12201335	1835	5G	183
12201336	1836	5G	183
12201337	1837	5G	183
12201338	1838	5G	183
12201339	1839	5G	183
12202345 008	1711	5G	183
12202350 008	1712	5G	183
1228005	1620	5G	183
1228010	1621	5G	183
1228015	1622	5G	183
1228020	1623	5G	183
1228025	1624	5G	183
1228030	1625	5G	183
1228035	1626	5G	183
1228040	1627	5G	183
1228045	1628	5G	183
1228050	1629	5G	183
1228055	1630	5G	183
1228060	1631	5G	183
1228065	1632	5G	183
1228070	1633	5G	183
1228075	1634	5G	183
1228080	1635	5G	183
1228085	1636	5G	183
1228090	1637	5G	183
1228095	1638	5G	183
12280100	1639	5G	183
12280105	1640	5G	183
12280110	1641	5G	183
12280115	1642	5G	183
12280120	1643	5G	183
12280125	1644	5G	183
12280130	1645	5G	183
12280135	1646	5G	183
12280140	1647	5G	183
12280145	1648	5G	183
12280150	1649	5G	183
12202305 001	1703	5G	184
12201102	1902	5G	184
12201103	1903	5G	184
12201104	1904	5G	184
12201105	1905	5G	184
12201106	1906	5G	184

CODE	ART.	CAT.	PAG.
12201107	1907	5G	184
12201108	1908	5G	184
12201109	1909	5G	184
12201110	1910	5G	184
12201111	1911	5G	184
12201112	1912	5G	184
12201113	1913	5G	184
12201114	1914	5G	184
12201115	1915	5G	184
12202310 001	1704	5G	184
12202315 001	1705	5G	184
12256505	1550	5E	184
12257005	1551	5E	184
12257505	1552	5E	185
12258005	1553	5E	185
12258505	1554	5E	185
12259005	1555	5E	185
12259505	1556	5E	185
12260005	1557	5E	185
12260505	1558	5E	186
12261005	1559	5E	186
12261505	1560	5E	186
12262005	1561	5E	186
12262505	1562	5E	186
12262510	1563	5E	186
12260101	1564	5E	187
12260201	1565	5E	187
12260301	1566	5E	187
12260401	1567	5E	187
12260402	1568	5E	187
12247505	1500-R40	5E	187
12248005	1501-R50	5E	188
12248505	1502-R50 T.T.	5E	188
12249005	1503-R50 T.T.	5E	188
12254505	1201-R40	5E	188
12255005	1202-R50 T.T.	5E	188
19400000	1204	5E	188
12250005	1215 40x18	5E	189
12250010	1215 40x20 (GR9)	5E	189
12250505	1215 45x20	5E	189
12250510	1215 50x20	5E	189
12250515	1215 50x25	5E	189
12251005	1220	5E	189
12251010	1220 - 7,5	5E	189
12251505	1221	5E	189
12252005	1225	5E	189
12252505	1227	5E	189
12205505 001	1231-36	5C	189
12206005 001	1232	5C	190
12206505 001	1233	5C	190
12253505	1235	5G	190
12253005	1264	5G	190
11802010 001	1245	5A	190
11704505	1255 mm3	5H	190

CODE	ART.	CAT.	PAG.
11704510	1255 mm4	5H	190
11704515	1255 mm5	5H	190
11803005	1270i	5A	191
11803505 001	1275	5A	191
11803505	1275i	5A	191
11804005	1276i	5A	191
13500302	1457	5B	192
13500303	1461	5B	192
13501003	1468-A	5B	192

PULL HANDLES



CODE	ART.	CAT.	PAG.
M200B001XA604	2-0722-604	4E	196
M200C003XA604	2-0744-604	4E	196
M200D010XA604	2-0762-604	4E	196
M200D001XA604	2-0764-604	4E	196
M200D006XA503	2-0765-503	4E	196
M200D002XA604	2-0766-604	4E	196
M200E001XA503	2-0782-503	4E	196
M200E002XA604	2-0786-604	4E	196
M200E002XA503	2-0786-503	4E	196
M210D001XA604	2-1763-604	4E	196
M210D003XA604	2-1767-604	4E	196
M220D005XA503	2-2762-503	4E	197
M220D005XA604	2-2762-604	4E	197
M220D001XA604	2-2764-604	4E	197
M220D001XA503	2-2764-503	4E	197
M220D002XA604	2-2766-604	4E	197
M220D002XA503	2-2766-503	4E	197
M220E001XA604	2-2782-604	4E	197
M220E001XA503	2-2782-503	4E	197
M260D001XA604	2-6765-604	4E	197
M260D002XA503	2-6767-503	4E	197
M260E001XA604	2-6783-604	4E	197
M260E001XA503	2-6783-503	4E	197
M260E002XA604	2-6785-604	4E	197
M260E002XA503	2-6785-503	4E	197
M270D001XA604	2-7763-604	4E	197
M270D001XA503	2-7763-503	4E	197
M270D002XA604	2-7765-604	4E	197
M270D002XA503	2-7765-503	4E	197
M270E003XA604	2-7788-604	4E	197
M270E003XA503	2-7788-503	4E	197
M280E002DA604	2-8786-604 DX	4E	198
M280E002SA604	2-8786-604 SX	4E	198
M280E002DA503	2-8786-503 DX	4E	198
M280E002SA503	2-8786-503 SX	4E	198
M290D001XA604	2-9765-604	4E	198
M290D002XA604	2-9768-604	4E	198
M290E002XA604	2-9788-604	4E	198
M292D002XA604	2-9862-604	4E	198
M292E001XA604	2-9883-604	4E	198
M292E001XA503	2-9883-9005	4E	198
M200B001XB010	2-0122-010	4D	199
M200B002XB010	2-0125-010	4D	199
N200C003XB009	2-0144-009	4D	199
N200D001XB009	2-0164-009	4D	199
N200D001XB010	2-0164-010	4D	199
N200D002XB010	2-0166-010	4D	199
N200E001XB010	2-0182-010	4D	199
N200E001XB015	2-0182-015	4D	199
N200E002XB010	2-0186-010	4D	199
N210C002XB010	2-1147-010	4D	199
N210D001XB010	2-1163-010	4D	199
N210D001XB015	2-1163-015	4D	199
N210D002XB010	2-1165-010	4D	199

CODE	ART.	CAT.	PAG.
N210D002XB015	2-1165-015	4D	199
N210D003XB009	2-1167-009	4D	199
N210D003XB010	2-1167-010	4D	199
N220C002XB015	2-2141-015	4D	200
N220C001XB010	2-2146-010	4D	200
N220D001XB009	2-2164-009	4D	200
N220D001XB010	2-2164-010	4D	200
N220D002XB010	2-2166-010	4D	200
N220E001XB010	2-2182-010	4D	200
N220E001XB015	2-2182-015	4D	200
N220E002XB010	2-2186-010	4D	200
N260D001XB010	2-6165-010	4D	200
N260D001XB015	2-6165-015	4D	200
N260D002XB010	2-6167-010	4D	200
N260E001XB010	2-6183-010	4D	200
N260E002XB010	2-6185-010	4D	200
N260E002XB015	2-6185-015	4D	200
N270D001XB010	2-7163-010	4D	201
N270D002XB010	2-7165-010	4D	201
N270E002XB010	2-7185-010	4D	201
N270E003XB010	2-7188-010	4D	201
N280D002DB010	2-8166-010	4D	201
N280D002SB010	2-8166-010	4D	201
N280E002SB010	2-8186-010	4D	201
N290D001XB010	2-9165-010	4D	202
N290E001XB010	2-9185-010	4D	202
N292D002XB010	2-9262-010	4D	202
N292D001XB010	2-9265-010	4D	202
N292E001XB009	2-9283-009	4D	202
N292E001XB010	2-9283-010	4D	202
N292E001XB015	2-9283-015	4D	202
N300D001DB010	3-0166-010 DX	4D	203
N400C002XB009	4-0042-009	4D	203
N400C002XB010	4-0042-010	4D	203
N400D002XB010	4-0064-010	4D	203
N400D003XB010	4-0066-010	4D	203
N400D004XB010	4-0068-010	4D	203
N400D002XB010	4-293-010	4D	203
N400D004XB010	4-0068-010	4D	203
N401D001XB010	4-0164-010	4D	204
N401D003XB010	4-0168-010	4D	204
N401E002XB010	4-0185-010	4D	204
N430D001XB010	4-3064-010	4D	204
N430E001XB010	4-3085-010	4D	204
N440D001XB009	4-4062-009	4D	205
N440D001XB010	4-4062-010	4D	205
N440D002XB010	4-4064-010	4D	205
N440E001XB010	4-4082-010	4D	205
N440E002XB010	4-4084-010	4D	205
N440E003XB010	4-4088-010	4D	205
N482C001XB010	4-8244-010	4D	205
M500B003XB010	5-0025-010	4D	206
N500C002XB010	5-0045-010	4D	206

CODE	ART.	CAT.	PAG.
N500E002XB010	5-0085-010	4D	206
N540D901XB010	5-201-010	4D	206
N520C001XB010	5-2046-010	4D	206
N520D003XB010	5-2066-010	4D	206
N520E003XB010	5-2086-010	4D	206
N530E001XB010	5-3085-010	4D	207
N540C001XB010	5-4043-010	4D	207
N540D003XB010	5-4062-010	4D	207
N540D003XB015	5-4062-015	4D	207
N540D001XB009	5-4065-009	4D	207
N540D001XB010	5-4065-010	4D	207
N540D002XB010	5-4068-010	4D	207
N540E001XB010	5-4082-010	4D	207
N540E001XB015	5-4082-015	4D	207
N540E002XB010	5-4085-010	4D	207
N540E003XB010	5-4088-010	4D	207
N550D001XB010	5-5063-010	4D	207
N700D002XB010	7-0064-010	4D	208
N700D009XB010	7-0086-010	4D	208
N710D006XB010	7-1066-010	4D	208
N800B003XB010	8-0048-010	4D	209
N800B009XB010	8-0086-010	4D	209
N810B003XB010	8-1048-010	4D	209
N810B009XB010	8-1086-010	4D	209
N815B003XB010	8-1548-010	4D	209
N815B009XB010	8-1586-010	4D	209
N820B003XB010	8-2048-010	4D	210
N820B007XB010	8-2087-010	4D	210
N830B002XB010	8-3048-010	4D	210
N830B003XB010	8-3088-010	4D	210
N900D003XB010	9-0048-010	4D	211
N900D007XB010	9-0087-010	4D	211
N910D003XB010	9-1048-010	4D	211
N910D007XB010	9-1087-010	4D	211
N915D003XB010	9-1548-010	4D	212
N920D003XB010	9-2048-010	4D	212
N920D007XB010	9-2087-010	4D	212
N930D006XB010	9-3066-010	4D	212
N930D010XB010	9-3089-010	4D	212
N940D003XB010	9-4048-010	4D	213
N940D007XB010	9-4087-010	4D	213
N950D003XB010	9-5048-010	4D	213
N950D007XB010	9-5087-010	4D	213
N960D003XB010	9-6048-010	4D	213
N960D007XB010	9-6087-010	4D	213
13063000 503	6-3085-9005	4H	214
13064000 503	6-4065-9005	4H	214
13064001 503	6-4085-9005	4H	214
13065001 503	6-5085-9005	4H	215
13065001 512	6-5085-9010	4H	215
13067000 503	6-7085-9005	4H	215
11111530	F0016	4B	218
11103435	F0018	4B	218
11112030	F0036	4B	218

PULL HANDLES



CODE	ART.	CAT.	PAG.	CODE	ART.	CAT.	PAG.	CODE	ART.	CAT.	PAG.
11116135	F0038	4B	218								
11113030	F0046	4B	218								
11108135	F0048	4B	219								
11112530	F0056B	4B	219								
11112531	F0056N	4B	219								
11110135	F0058B	4B	219								
11110136	F0058N	4B	219								
11129035	F0068	4B	219								
11100001	F1000	4B	220								
11101620	F1012	4B	220								
11107220	F1042	4B	220								
11100011	F1100	4B	220								
11128025	F1114	4B	221								
11128030	F1116	4B	221								
11108638	F1119	4B	221								
11108637	F1120	4B	221								
11100021	F1200	4B	221								
11100032	F1325L	4B	221								
11100033	F1325PVD	4B	221								
11100031	F1325S	4B	221								
11100042	F1330L	4B	221								
11100043	F1330PVD	4B	221								
11100041	F1330S	4B	221								
11100052	F1335L	4B	221								
11100053	F1335PVD	4B	221								
11100051	F1335S	4B	221								
11100061	F1400	4B	222								
11100071	F2000	4B	222								
11100072	F2001	4B	222								
11100082	F3025L	4B	222								
11100083	F3025PVD	4B	222								
11100081	F3025S	4B	222								
11100092	F3030L	4B	222								
11100093	F3030PVD	4B	222								
11100091	F3030S	4B	222								
11100102	F3035L	4B	222								
11100103	F3035PVD	4B	222								
11100101	F3035S	4B	222								
11100625	F7014	4B	223								
11100630	F7016	4B	223								
11104625	F7034	4B	223								
11104630	F7036	4B	223								
11106625	F7044	4B	223								
11106630	F7046	4B	223								



FRAME AUTOMATION

CODE	ART.	CAT.	PAG.
ML00AA01NOB00	ACCESSORI SMART	8V	228
ML00AA01NOG00	ACCESSORI SMART	8V	228
ML00AA01NOW00	ACCESSORI SMART	8V	228
ML00AA01N1W00	ACCESSORI SMART	8V	228
ML00AA03NOB00	ACCESSORI SMART	8V	228
ML00AA03NOG00	ACCESSORI SMART	8V	228
ML00AA03NOW00	ACCESSORI SMART	8V	228
ML00AA03N1W00	ACCESSORI SMART	8V	228
ML00AS01NOB00	ACCESSORI SMART	8V	228
ML00AS01NOG00	ACCESSORI SMART	8V	228
ML00AS01NOW00	ACCESSORI SMART	8V	228
ML00AS01N1W00	ACCESSORI SMART	8V	228
ML00AS02NOW00	ACCESSORI SMART	8V	228
ML00AS02NOB00	ACCESSORI SMART	8V	228
ML00AS02NOG00	ACCESSORI SMART	8V	228
ML00AS03NOW00	ACCESSORI SMART	8V	228
ML00AS03NOB00	ACCESSORI SMART	8V	228
ML00AS03NOG00	ACCESSORI SMART	8V	228
ML00AS05NOW00	ACCESSORI SMART	8V	228
ML00AS05NOB00	ACCESSORI SMART	8V	228
ML00AS05NOG00	ACCESSORI SMART	8V	228
MSMART20LOB00	SMART-24V basic	8V	229
MSMART20LOG00	SMART-24V basic	8V	229
MSMART20LOW00	SMART-24V basic	8V	229
MSMART20IOB00	SMART-110V basic	8V	229
MSMART20IOG00	SMART-110V basic	8V	229
MSMART20IOW00	SMART-110V basic	8V	229
MSMART20HOB00	SMART-230V basic	8V	229
MSMART20HOG00	SMART-230V basic	8V	229
MSMART20HOW00	SMART-230V basic	8V	229
ML00AA01NOB00	ACCESSORI LIWIN	8V	230
ML00AA01NOG00	ACCESSORI LIWIN	8V	230
ML00AA01NOW00	ACCESSORI LIWIN	8V	230
ML00AA01N1W00	ACCESSORI LIWIN	8V	230
ML00AA03NOB00	ACCESSORI LIWIN	8V	230
ML00AA03NOG00	ACCESSORI LIWIN	8V	230
ML00AA03NOW00	ACCESSORI LIWIN	8V	230
ML00AA03N1W00	ACCESSORI LIWIN	8V	230
ML00AS01NOB00	ACCESSORI LIWIN	8V	230
ML00AS01NOG00	ACCESSORI LIWIN	8V	230
ML00AS01NOW00	ACCESSORI LIWIN	8V	230
ML00AS01N1W00	ACCESSORI LIWIN	8V	230
ML00AS02NOW00	ACCESSORI LIWIN	8V	230
ML00AS02NOB00	ACCESSORI LIWIN	8V	230
ML00AS02NOG00	ACCESSORI LIWIN	8V	230
ML00AS03NOW00	ACCESSORI LIWIN	8V	230
ML00AS03NOB00	ACCESSORI LIWIN	8V	230
ML00AS03NOG00	ACCESSORI LIWIN	8V	230
ML00AS05NOW00	ACCESSORI LIWIN	8V	230
ML00AS05NOB00	ACCESSORI LIWIN	8V	230
ML00AS05NOG00	ACCESSORI LIWIN	8V	230
ML25S138IOB00	LIWIN-L25 110V basic	8A	231

CODE	ART.	CAT.	PAG.
ML25S138IOG00	LIWIN-L25 110V basic	8A	231
ML25S138IOW00	LIWIN-L25 110V basic	8A	231
ML25S138HOB00	LIWIN-L25 230V basic	8A	231
ML25S138HOG00	LIWIN-L25 230V basic	8A	231
ML25S138H0W00	LIWIN-L25 230V basic	8A	231
ML25S138H1W00	LIWIN-L25 230V basic	8A	231
ML35S140HOB00	LIWIN-L35 230V basic	8A	231
ML35S140HOG00	LIWIN-L35 230V basic	8A	231
ML35S140H0W00	LIWIN-L35 230V basic	8A	231
ML35S140H1W00	LIWIN-L35 230V basic	8A	231
ML35S140LOB00	LIWIN-L35 24V basic	8A	231
ML35S140LOG00	LIWIN-L35 24V basic	8A	231
ML35S140LOW00	LIWIN-L35 24V basic	8A	231
ML35S140L0W00	LIWIN-L35 24V basic	8A	231
ML35S240HOB00	LIWIN-L35 230V 2W-NET	8A	232
ML35S240HOG00	LIWIN-L35 230V 2W-NET	8A	232
ML35S240H0W00	LIWIN-L35 230V 2W-NET	8A	232
ML35S240LOB00	LIWIN-L35 24V 2W-NET	8A	232
ML35S240LOG00	LIWIN-L35 24V 2W-NET	8A	232
ML35S340LOW00	LIWIN-L35 24V 3W-NET	8A	232
ML35S340HOB00	LIWIN-L35 230V 3W-NET	8A	232
ML35S340HOG00	LIWIN-L35 230V 3W-NET	8A	232
ML35S340H0W00	LIWIN-L35 230V 3W-NET	8A	232
ML35S340LOB00	LIWIN-L35 24V 3W-NET	8A	232
ML35S340LOG00	LIWIN-L35 24V 3W-NET	8A	232
ML35S440HOB00	LIWIN-L35 230V 4W-NET	8A	232
ML35S440HOG00	LIWIN-L35 230V 4W-NET	8A	232
ML35S440H0W00	LIWIN-L35 230V 4W-NET	8A	232
ML35S440LOB00	LIWIN-L35 24V 4W-NET	8A	232
ML35S440LOG00	LIWIN-L35 24V 4W-NET	8A	232
ML35S440LOW00	LIWIN-L35 24V 4W-NET	8A	232
ML35R140HOB00	LIWIN-L35 230V R	8A	233
ML35R140HOG00	LIWIN-L35 230V R	8A	233
ML35R140H0W00	LIWIN-L35 230V R	8A	233
ML35R240HOB00	LIWIN-L35 230V R 2W-NET	8A	233
ML35R240HOG00	LIWIN-L35 230V R 2W-NET	8A	233
ML35R240H0W00	LIWIN-L35 230V R 2W-NET	8A	233
ML35R340HOB00	LIWIN-L35 230V R 3W-NET	8A	233
ML35R340HOG00	LIWIN-L35 230V R 3W-NET	8A	233
ML35R340H0W00	LIWIN-L35 230V R 3W-NET	8A	233
ML35R440HOB00	LIWIN-L35 230V R 4W-NET	8A	233
ML35R440HOG00	LIWIN-L35 230V R 4W-NET	8A	233
ML35R440H0W00	LIWIN-L35 230V R 4W-NET	8A	233
MFASTS01NOG00	ACCESSORI FAST	8V	234
MR00AA01NOG00	ACCESSORI FAST	8V	234
MFAST160HOB00	FAST-160 230V	8B	235
MFAST200HOB00	FAST-200 230V	8B	235
MFAST300HOB00	FAST-300 230V	8B	235
MFAST400HOB00	FAST-400 230V	8B	235
MR00AS01NOG00	ACCESSORI RAYWIN	8V	236
MR00AA01NOG00	ACCESSORI RAYWIN	8V	236

CODE	ART.	CAT.	PAG.
MR20S130HOG00	RAYWIN-R20/300 230V basic	8A	237
MR20S130LOG00	RAYWIN-R20/300 24V basic	8A	237
MR45S120HOG00	RAYWIN-R45/200 230V basic	8A	237
MR45S130HOG00	RAYWIN-R45/300 230V basic	8A	237
MR45S140HOG00	RAYWIN-R45/400 230V basic	8A	237
MR45S120LOG00	RAYWIN-R45/200 24V basic	8A	237
MR45S130LOG00	RAYWIN-R45/300 24V basic	8A	237
MR45S140LOG00	RAYWIN-R45/400 24V basic	8A	237
MR60S130HOG00	RAYWIN-R60/300 230V basic	8A	238
MR60S150HOG00	RAYWIN-R60/500 230V basic	8A	238
MR60S130LOG00	RAYWIN-R60/300 24V basic	8A	238
MR60S150LOG00	RAYWIN-R60/500 24V basic	8A	238
MR60S230HOG00	RAYWIN-R60/300 230V 2W-NET	8A	238
MR60S250HOG00	RAYWIN-R60/500 230V 2W-NET	8A	238
MR60S230LOG00	RAYWIN-R60/300 24V 2W-NET	8A	238
MR60S250LOG00	RAYWIN-R60/500 24V 2W-NET	8A	238
MR60S330HOG00	RAYWIN-R60/300 230V 3W-NET	8A	238
MR60S350HOG00	RAYWIN-R60/500 230V 3W-NET	8A	238
MR60S330LOG00	RAYWIN-R60/300 24V 3W-NET	8A	238
MR60S350LOG00	RAYWIN-R60/500 24V 3W-NET	8A	238
MR60S430HOG00	RAYWIN-R60/300 230V 4W-NET	8A	238
MR60S450HOG00	RAYWIN-R60/500 230V 4W-NET	8A	238
MR60S430LOG00	RAYWIN-R60/300 24V 4W-NET	8A	238
MR60S450LOG00	RAYWIN-R60/500 24V 4W-NET	8A	238
MR60S103HOG00	RAYWIN-R600-300R 230V basic	8A	239
MR60S105HOG00	RAYWIN-R600-500R 230V basic	8A	239
MR60S103LOG00	RAYWIN-R600-300R 24V basic	8A	239
MR60S105LOG00	RAYWIN-R600-500R 24V basic	8A	239
MA00AB01NOG00	ACCESSORI AIRWIN	8V	240
MA00AB02NOG00	ACCESSORI AIRWIN	8V	240
MA00AB03NOG00	ACCESSORI AIRWIN	8V	240
MA00AB04NOG00	ACCESSORI AIRWIN	8V	240
MA00AB05NOG00	ACCESSORI AIRWIN	8V	240
MA00XX02NOG00	ACCESSORI AIRWIN	8V	240
MR00AS01NOG00	ACCESSORI AIRWIN	8V	240
MR00AA01NOG00	ACCESSORI AIRWIN	8V	240
MA45S118HOG00	AIRWIN-A45/180 230V basic	8C	241
MA45S123HOG00	AIRWIN-A45/230 230V basic	8C	241
MA45S135HOG00	AIRWIN-A45/350 230V basic	8C	241
MA45S155HOG00	AIRWIN-A45/550 230V basic	8C	241
MA45S175HOG00	AIRWIN-A45/750 230V basic	8C	241
MA45S10AHOG00	AIRWIN-A45/1000 230V basic	8C	241
MA45S118LOG00	AIRWIN-A45/180 24V basic	8C	241
MA45S123LOG00	AIRWIN-A45/230 24V basic	8C	241
MA45S135LOG00	AIRWIN-A45/350 24V basic	8C	241
MA45S155LOG00	AIRWIN-A45/550 24V basic	8C	241
MA45S175LOG00	AIRWIN-A45/750 24V basic	8C	241
MA45S10ALOG00	AIRWIN-A45/1000 24V basic	8C	241
MA65S118HOG00	AIRWIN-A65/180 230V basic	8C	242
MA65S123HOG00	AIRWIN-A65/230 230V basic	8C	242
MA65S135HOG00	AIRWIN-A65/350 230V basic	8C	242
MA65S155HOG00	AIRWIN-A65/550 230V basic	8C	242



CODE	ART.	CAT.	PAG.	CODE	ART.	CAT.	PAG.	CODE	ART.	CAT.	PAG.
MA65S175HOG00	AIRWIN-A65/750 230V basic	8C	242	MSPIN14EHOB00	SPIN140E	8D	244	MS35SM06HOB00	SHOWIN-S35 6N 230V	8A	247
MA65S10AHO00	AIRWIN-A65/1000 230V basic	8C	242	MSPIN18EHOB00	SPIN180E	8D	244	MS35SM10HOB00	SHOWIN-S35 10N 230V	8A	247
MA65S118LOG00	AIRWIN-A65/180 24V basic	8C	242	MP00X001H0000	AF 940 HP	8D	244	MS45SM10HOB00	SHOWIN-S45 10N 230V	8A	248
MA65S123LOG00	AIRWIN-A65/230 24V basic	8C	242	MP00X002H0000	AF 940 BASIC	8D	244	MS45SM20HOB00	SHOWIN-S45 20N 230V	8A	248
MA65S135LOG00	AIRWIN-A65/350 24V basic	8C	242	MP00E001H0000	AF 900	8D	245	MS45SM30HOB00	SHOWIN-S45 30N 230V	8A	248
MA65S155LOG00	AIRWIN-A65/550 24V basic	8C	242	MP00E002H0000	AF990	8D	245	MS45SM40HOB00	SHOWIN-S45 40N 230V	8A	248
MA65S175LOG00	AIRWIN-A65/750 24V basic	8C	242	MP00M00100B00	AF 540	8D	245	MS45SM50HOB00	SHOWIN-S45 50N 230V	8A	248
MA65S10ALOG00	AIRWIN-A65/1000 24V basic	8C	242	MP00M00100B00	AF 540	8D	245	MS45MM20HOB00	SHOWIN-S45 20N M/S 230V	8A	248
MA65S218HOG00	AIRWIN-A65/180 230V 2W-NET	8C	242	MP00M00100B00	AF 540	8D	245	MS45MM30HOB00	SHOWIN-S45 30N M/S 230V	8A	248
MA65S223HOG00	AIRWIN-A65/230 230V 2W-NET	8C	242	MP00M003H0000	AF 550	8D	245	MS45MM40HOB00	SHOWIN-S45 40N M/S 230V	8A	248
MA65S235HOG00	AIRWIN-A65/350 230V 2W-NET	8C	242	GDARTSLMNOB00	DART-SLIM-SYNC	8D	245	MS45MM50HOB00	SHOWIN-S45 50N M/S 230V	8A	248
MA65S255HOG00	AIRWIN-A65/550 230V 2W-NET	8C	242	GINDEXEUNOB00	INDEX-EU	8D	245	MS45RM20HOB00	SHOWIN-S45 20N C/RIC 230V	8A	248
MA65S275HOG00	AIRWIN-A65/750 230V 2W-NET	8C	242	GTACTSTDNOB00	TACT	8D	245	MS45RM30HOB00	SHOWIN-S45 30N C/RIC 230V	8A	248
MA65S20AHO00	AIRWIN-A65/1000 230V 2W-NET	8C	242	GTACTDECNOB00	TACT-DEC	8D	245	MS45RM40HOB00	SHOWIN-S45 40N C/RIC 230V	8A	248
MA65S218LOG00	AIRWIN-A65/180 24V 2W-NET	8C	242	GANTENNANO000	AC-30	8D	245	MS45RM50HOB00	SHOWIN-S45 50N C/RIC 230V	8A	248
MA65S223LOG00	AIRWIN-A65/230 24V 2W-NET	8C	242	GRESIVERNOG00	RECEIVER	8D	245	MS45RR30HOB00	S45-30N-3FC	8D	249
MA65S235LOG00	AIRWIN-A65/350 24V 2W-NET	8C	242	GVCTR2STNOV00	VICTOR 2RC Verde	8D	245	MS45RR50HOB00	S45-50N-3FC	8D	249
MA65S255LOG00	AIRWIN-A65/550 24V 2W-NET	8C	242	GVCTR2STNOLO0	VICTOR 2RC Blu	8D	245	MS59SM80HOB00	SHOWIN-S59 80N 230V	8A	250
MA65S275LOG00	AIRWIN-A65/750 24V 2W-NET	8C	242	GVCTR2STNOY00	VICTOR 2RC Giallo	8D	245	MS59SM0AHO00	SHOWIN-S59 100N 230V	8A	250
MA65S20ALOG00	AIRWIN-A65/1000 24V 2W-NET	8C	242	GVCTR2STNOR00	VICTOR 2RC Rosso	8D	245	MS59MM80HOB00	SHOWIN-S59 80N M/S 230V	8A	250
MA65S318HOG00	AIRWIN-A65/180 230V 3W-NET	8C	243	GVCTR2STNOR00	VICTOR 2RC Rosso	8D	245	MS59MM0AHO00	SHOWIN-S59 100N M/S 230V	8A	250
MA65S323HOG00	AIRWIN-A65/230 230V 3W-NET	8C	243	GVCTR4STNOV00	VICTOR 4RC Verde	8D	245	MX00AT01NOW00	R1 CONTROL	8A	251
MA65S335HOG00	AIRWIN-A65/350 230V 3W-NET	8C	243	GVCTR4STNOL00	VICTOR 4RC Blu	8D	245	MX00AT06NOW00	R6 CONTROL	8A	251
MA65S355HOG00	AIRWIN-A65/550 230V 3W-NET	8C	243	GVCTR4STNOY00	VICTOR 4RC Giallo	8D	245	MX00AT01NYW00	R1 CONTROL	8A	251
MA65S375HOG00	AIRWIN-A65/750 230V 3W-NET	8C	243	GVCTR4STNOR00	VICTOR 4RC Rosso	8D	245	MX00AT06NYW00	R6 CONTROL	8A	251
MA65S30AHO00	AIRWIN-A65/1000 230V 3W-NET	8C	243	GVCTR4STNOG00	VICTOR 4RC Ardesia	8D	245	MX00AT01NVW00	R1 CONTROL	8A	251
MA65S318LOG00	AIRWIN-A65/180 24V 3W-NET	8C	243	MS00XX01NOG00	ACCESSORI SHOWIN	8V	246	MX00AT06NVW00	R6 CONTROL	8A	251
MA65S323LOG00	AIRWIN-A65/230 24V 3W-NET	8C	243	MS00XX02NOG00	ACCESSORI SHOWIN	8V	246	MX00AT01NBW00	R1 CONTROL	8A	251
MA65S335LOG00	AIRWIN-A65/350 24V 3W-NET	8C	243	MS00XX03NOG00	ACCESSORI SHOWIN	8V	246	MX00AT06NBW00	R6 CONTROL	8A	251
MA65S355LOG00	AIRWIN-A65/550 24V 3W-NET	8C	243	MS00XX04NOG00	ACCESSORI SHOWIN	8V	246	MX00AT01NGW00	R1 CONTROL	8A	251
MA65S375LOG00	AIRWIN-A65/750 24V 3W-NET	8C	243	MS00XX05NOG00	ACCESSORI SHOWIN	8V	246	MX00AT06NGW00	R6 CONTROL	8A	251
MA65S30ALOG00	AIRWIN-A65/1000 24V 3W-NET	8C	243	MS00XX06NOG00	ACCESSORI SHOWIN	8V	246	MX00AT01NAW00	R1 CONTROL	8A	251
MA65S418HOG00	AIRWIN-A65/180 230V 4W-NET	8C	243	MS35AP01NOB00	ACCESSORI SHOWIN	8V	246	MX00AT06NAW00	R6 CONTROL	8A	251
MA65S423HOG00	AIRWIN-A65/230 230V 4W-NET	8C	243	MS35AP02NOB00	ACCESSORI SHOWIN	8V	246	MX00WB03HOB00	ACCESSORI WBUS	8V	252
MA65S435HOG00	AIRWIN-A65/350 230V 4W-NET	8C	243	MS45AP01NOB00	ACCESSORI SHOWIN	8V	246	MX00WB04HOB00	ACCESSORI WBUS	8V	252
MA65S455HOG00	AIRWIN-A65/550 230V 4W-NET	8C	243	MS45AP02NOB00	ACCESSORI SHOWIN	8V	246	MX00WB05HOB00	ACCESSORI WBUS	8V	252
MA65S475HOG00	AIRWIN-A65/750 230V 4W-NET	8C	243	MS45AP03NOB00	ACCESSORI SHOWIN	8V	246	MX00WB06HOB00	ACCESSORI WBUS	8V	252
MA65S40AHO00	AIRWIN-A65/1000 230V 4W-NET	8C	243	MS45AP04NOB00	ACCESSORI SHOWIN	8V	246	MX00WB07HOB00	ACCESSORI WBUS	8V	252
MA65S418LOG00	AIRWIN-A65/180 24V 4W-NET	8C	243	MS45AP05NOB00	ACCESSORI SHOWIN	8V	246	MX00WB08HOB00	ACCESSORI WBUS	8V	252
MA65S423LOG00	AIRWIN-A65/230 24V 4W-NET	8C	243	MS45AP06NOB00	ACCESSORI SHOWIN	8V	246	MX00WB09HOB00	ACCESSORI WBUS	8V	252
MA65S435LOG00	AIRWIN-A65/350 24V 4W-NET	8C	243	MS45AS01NOG00	ACCESSORI SHOWIN	8V	246	ML35WB40HOB00	LIWIN-L35 230V WBUS 230V	8A	238
MA65S455LOG00	AIRWIN-A65/550 24V 4W-NET	8C	243	MS45AS02NOG00	ACCESSORI SHOWIN	8V	246	ML35WB40HOG00	LIWIN-L35 230V WBUS 230V	8A	238
MA65S475LOG00	AIRWIN-A65/750 24V 4W-NET	8C	243	MS45AS04NOG00	ACCESSORI SHOWIN	8V	246	ML35WB40HOW00	LIWIN-L35 230V WBUS 230V	8A	238
MA65S40ALOG00	AIRWIN-A65/1000 24V 4W-NET	8C	243	MS45AS05NOG00	ACCESSORI SHOWIN	8V	246	ML35RB40HOB00	LIWIN-L35 230V WBUS+R	8A	238
MA00MC18NOG00	AIRWIN-A180 MECH	8C	243	MS45AS06NOG00	ACCESSORI SHOWIN	8V	246	ML35RB40HOW00	LIWIN-L35 230V WBUS+R	8A	238
MA00MC23NOG00	AIRWIN-A230 MECH	8C	243	MS45AS07NOG00	ACCESSORI SHOWIN	8V	246	ML35RB40HOG00	LIWIN-L35 230V WBUS+R	8A	238
MA00MC35NOG00	AIRWIN-A350 MECH	8C	243	MS45AS08NOG00	ACCESSORI SHOWIN	8V	246	ML35WB40LOB00	LWIN-L35 24V WBUS	8A	253
MA00MC55NOG00	AIRWIN-A550 MECH	8C	243	MS45AS09NOG00	ACCESSORI SHOWIN	8V	246	ML35WB40LOW00	LWIN-L35 24V WBUS	8A	253
MA00MC75NOG00	AIRWIN-A750 MECH	8C	243	MS45AS10NOG00	ACCESSORI SHOWIN	8V	246	ML35WB40LOG00	LWIN-L35 24V WBUS	8A	253
MA00MCOANOG00	AIRWIN-A1000 MECH	8C	243	MS59AP01NOB00	ACCESSORI SHOWIN	8V	246	ML35RB40LOG00	LWIN-L35 24V WBUS+R	8A	253
MSPIN140HOB00	SPIN140	8D	244	MS59AP02NOB00	ACCESSORI SHOWIN	8V	246	ML35RB40LOB00	LWIN-L35 24V WBUS+R	8A	253
MSPIN180HOB00	SPIN180	8D	244	MS59AS03NOG00	ACCESSORI SHOWIN	8V	246	ML35RB40LOW00	LWIN-L35 24V WBUS+R	8A	253
				MS59AS04NOG00	ACCESSORI SHOWIN	8V	246				



CODE	ART.	CAT.	PAG.
MA65WB18HOG00	AIRWIN-A65/180 230V WBUS	8A	253
MA65WB23HOG00	AIRWIN-A65/230 230V WBUS	8A	253
MA65WB35HOG00	AIRWIN-A65/350 230V WBUS	8A	253
MA65WB55HOG00	AIRWIN-A65/550 230V WBUS	8A	253
MA65WB75HOG00	AIRWIN-A65/750 230V WBUS	8A	253
MA65WB0AHOG00	AIRWIN-A65/1000 230V WBUS	8A	253
MA65RB18HOG00	AIRWIN-A65/180 230V WBUS+R	8A	253
MA65RB23HOG00	AIRWIN-A65/230 230V WBUS+R	8A	253
MA65RB35HOG00	AIRWIN-A65/350 230V WBUS+R	8A	253
MA65RB55HOG00	AIRWIN-A65/550 230V WBUS+R	8A	253
MA65RB75HOG00	AIRWIN-A65/750 230V WBUS+R	8A	253
MA65RB0AHOG00	AIRWIN-A65/1000 230V WBUS+R	8A	253
MA65WB18LOG00	AIRWIN-A65/180 24V WBUS	8A	254
MA65WB23LOG00	AIRWIN-A65/230 24V WBUS	8A	254
MA65WB35LOG00	AIRWIN-A65/350 24V WBUS	8A	254
MA65WB55LOG00	AIRWIN-A65/550 24V WBUS	8A	254
MA65WB75LOG00	AIRWIN-A65/750 24V WBUS	8A	254
MA65WB0ALOG00	AIRWIN-A65/1000 24V WBUS	8A	254
MA65RB18LOG00	AIRWIN-A65/180 24V WBUS+R	8A	254
MA65RB23LOG00	AIRWIN-A65/230 24V WBUS+R	8A	254
MA65RB35LOG00	AIRWIN-A65/350 24V WBUS+R	8A	254
MA65RB55LOG00	AIRWIN-A65/550 24V WBUS+R	8A	254
MA65RB75LOG00	AIRWIN-A65/750 24V WBUS+R	8A	254
MA65RB0ALOG00	AIRWIN-A65/1000 24V WBUS+R	8A	254
MR60WB30HOG00	RAYWIN-R60-300 230V WBUS	8A	254
MR60WB50HOG00	RAYWIN-R60-500 230V WBUS	8A	254
MR60RB30HOG00	RAYWIN-R60-300 230V WBUS+R	8A	254
MR60RB50HOG00	RAYWIN-R60-500 230V WBUS+R	8A	254
MR60WB30LOG00	RAYWIN-R60-300 24V WBUS	8A	254
MR60WB50LOG00	RAYWIN-R60-500 24V WBUS	8A	254
MR60RB30LOG00	RAYWIN-R60-300 24V WBUS+R	8A	254
MR60RB50LOG00	RAYWIN-R60-500 24V WBUS+R	8A	254
MP00E003H0000	TWIN	8C	255
MP00X003H0000	AF950	8C	255



Mechanical
excellence



CONDIZIONI GENERALI DI VENDITA

1. GENERALITÀ

1.1 Il presente documento si rivolge ai clienti (di seguito "Clienti") di FRATELLI COMUNELLO SPA (di seguito solo COMUNELLO) con esso si intendono rendere note le condizioni contrattuali che COMUNELLO applicherà in tutte le vendite dei propri prodotti (di seguito CONDIZIONI GENERALI DI VENDITA), salvo diverse specifiche pattuizioni in deroga a quanto qui riportato, trattasi, in ogni caso, di condizioni che risultano vincolanti ed efficaci tra le parti ai sensi dell'art. 1341 Codice Civile.

1.2. COMUNELLO applica in tutti i rapporti contrattuali di vendita dei propri prodotti la legge italiana, salvo apposite deroghe che dovranno essere concordate e provate per iscritto

1.3 Le Condizioni Generali di Vendita qui riportate si riferiscono esclusivamente ai prodotti portanti il marchio COMUNELLO (di seguito "Prodotti").

2. OFFERTE – PREVENTIVI

2.1 Le offerte formulate da COMUNELLO ai propri Clienti conservano efficacia per un periodo massimo di 20 (venti) giorni dalla data di invio delle stesse, in ogni caso dovranno essere formalizzate per iscritto, anche a mezzo mail.

2.2. Decorso tale termine l'offerta formulata da COMUNELLO dovrà ritenersi decaduta e non accettabile da parte del CLIENTE, salvo diverso specifico accordo scritto tra le parti contrattuali

3. ORDINI

3.1 Gli ordini d'acquisto sottoscritti dai Clienti ed indirizzati a COMUNELLO dovranno essere confermati mediante apposito modulo predisposto da COMUNELLO (conferma d'ordine), che ciascun Cliente dovrà ritrasmettere a quest'ultima società, indicando, con precisione, il quantitativo della merce compravenduta e le ulteriori caratteristiche dei prodotti richiesti, previa apposizione della firma.

3.2 Il contratto d'acquisto si intende perfezionato e vincolante tra le parti mediante:

a) conferma dell'ordine d'acquisto da parte di FRATELLI COMUNELLO SPA;

b) con l'esecuzione materiale dell'ordine d'acquisto da parte di FRATELLI COMUNELLO, purché rispettoso del contenuto della vendita conclusa tra le parti.

3.3 Qualsiasi modifica o integrazione di singole disposizioni delle Condizioni Generali di Vendita o dell'ordine d'acquisto sono prive di efficacia se non sono state approvate per iscritto da COMUNELLO SPA. In caso di modifiche all'ordine d'acquisto, intervenute successivamente all'inoltro del modulo indicato al punto 3.1., le stesse non potranno considerarsi efficaci se nel frattempo COMUNELLO ha accettato l'ordine o vi ha dato esecuzione anche parziale, COMUNELLO si riserva comunque il diritto di annullare l'ordine d'acquisto originario e di sospendere l'esecuzione di quello in corso, chiedendo il risarcimento dei danni.

3.4 La data di consegna dei Prodotti indicata negli ordini d'acquisto ha sempre e comunque valore indicativo e l'eventuale ritardo rispetto a tale termine, per un periodo non superiore a giorni 30, non potrà mai costituire ragione per il CLIENTE affinché questi possa avanzare pretese risarcitorie nei confronti di COMUNELLO o per risolvere il rapporto contrattuale.

In particolare COMUNELLO si riserva la facoltà di prorogare i termini di consegna per caso fortuito o forza maggiore o comunque per eventi non prevedibili al momento della conclusione della vendita (ad esempio, per difficoltà di approvvigionamenti di materie prime e componenti); qualora prima della consegna del materiale il CLIENTE versi in una situazione di difficoltà finanziaria o comunque modifichi la propria forma giuridica, COMUNELLO potrà procedere alla sospensione dell'esecuzione del rapporto contrattuale interrompendone immediatamente l'esecuzione, ed eventualmente risolvendo il contratto.-

4. CONSEGNA E SPEDIZIONE

4.1 I Prodotti vengono consegnati al CLIENTE nel luogo di produzione ovvero presso la sede legale di COMUNELLO (di seguito "Consegna").

4.2 Nel caso in cui i Prodotti siano consegnati Ex-works Rosà o Cassola (IV) CONTOTERMS 2010, il passaggio del rischio si realizza dal momento della Consegna dei Prodotti da parte di FRATELLI COMUNELLO S.p.a. al Cliente od al vettore, il CLIENTE assume inoltre i costi del trasporto.

4.3 Salvo diverso accordo, FRATELLI COMUNELLO SPA stabilisce, in nome e per conto del Cliente, il tipo di spedizione, la via di trasporto e il vettore.

4.4 FRATELLI COMUNELLO SPA si riserva la facoltà di effettuare esecuzioni o Consegne parziali degli ordini d'acquisto. Il Cliente non potrà sollevare contestazione alcuna in ordine a consegne frazionate e/o parziali. Tutte le Consegne parziali verranno fatturate autonomamente ed i termini di pagamento decorreranno dalla data di ciascuna fattura. Il pagamento delle Consegne parziali non potrà essere differito all'ultimazione delle Consegne relative all'ordine d'acquisto originario. Anche in caso di consegne parziali, troverà applicazione quanto stabilito dall'articolo 4.1.

5. PREZZI E LISTINI

5.1 Per prezzo si intende quello indicato nell'ultimo listino COMUNELLO per i Prodotti consegnati al Cliente, imballaggio normale compreso, e spese di spedizione escluse (di seguito "Prezzo"). L'ultimo listino emesso da FRATELLI COMUNELLO SPA annulla tutti i listini precedenti ed, in assenza di diverse pattuizioni, sarà quello applicabile alla vendita.

6. PAGAMENTO

6.1 Il pagamento del Prezzo dovrà avvenire entro il termine pattuito tra le parti contraenti. Il mancato pagamento del Prezzo entro il termine convenuto determinerà la decorrenza di interessi per il ritardo di pagamento nelle transazioni commerciali, nella misura prevista dal D.Lgs. n. 231 del 9.10.2002 e successive modifiche ed integrazioni. Tali interessi decorreranno dalla scadenza del termine di pagamento è fatto salvo il maggior danno subito da COMUNELLO.-

6.2 Il Cliente non potrà proporre domande né formulare eccezioni nei confronti di COMUNELLO se non dopo aver provveduto al pagamento del Prezzo.

6.3 In caso di irregolarità nei pagamenti, COMUNELLO si riserva il diritto di sospendere l'esecuzione di tutti gli ordini di acquisto, anche se diversi da quelli per i quali si è verificato il ritardo o l'inadempimento da parte del CLIENTE, senza alcun preavviso né diritto di risarcimento di alcun danno da parte del CLIENTE.

7. RESI E RECLAMI

7.1 Tutti i reclami devono essere formulati per iscritto entro 8 (otto) giorni dalla ricezione dei Prodotti, siano essi relativi alla quantità o alla qualità dei Prodotti consegnati.

7.2 I resi dei Prodotti consegnati verranno accettati da FRATELLI COMUNELLO SPA soltanto previo accordo scritto ed esclusivamente con riguardo a Prodotti nuovi e completi di imballaggio originale.

7.3 I resi dovranno essere accompagnati dall'apposito documento di trasporto di reso, indicante l'autorizzazione scritta di FRATELLI COMUNELLO SPA nonché la quantità e la qualità dei Prodotti.

7.4 I resi non potranno considerarsi accettati da FRATELLI COMUNELLO SPA se non effettuati con le modalità di cui sopra ed in particolare non potrà intendersi quale accettazione di resi la presa in consegna di Prodotti presso la sede o i depositi di FRATELLI COMUNELLO SPA.

7.5 Sulla somma accreditata riferita a resi non dovuti a cause imputabili a FRATELLI COMUNELLO SPA, verrà operata una riduzione del 30% da considerarsi alla stregua di una liquidazione forfetaria del danno (clausola penale), addebitata al Cliente in ragione dei costi generali, di spedizione, deperimento della merce, vetustà etc sopportati da COMUNELLO.

8. GARANZIA

8.1 La presente garanzia nei rapporti commerciali o in caso di vendita di beni per uso professionale è limitata alla riparazione o sostituzione del pezzo del Prodotto riconosciuto da FRATELLI COMUNELLO SPA quale difettoso mediante Prodotti rigenerati equivalenti (di seguito "Garanzia Convenzionale"), non risulta compresa nella garanzia il costo necessario per le attività di riparazione e sostituzione del materiale (a titolo esemplificativo costi di manodopera, noleggio materiali, etc).-

8.2 E' esclusa l'applicazione della disciplina dettata dagli articoli 1490-1495 del Codice Civile,

8.3 FRATELLI COMUNELLO SPA garantisce il funzionamento dei Prodotti nei limiti indicati al superiore punto sub 8.1.. Salvo diverso accordo, la validità della Garanzia Convenzionale è di 24 (ventiquattro) mesi dalla data di produzione, rilevabile sui Prodotti. Per gli attuatori della linea Showin la garanzia è di 60 (sessanta) mesi dalla data di produzione, mentre per i restanti prodotti della linea Automation Frame la garanzia è di 36 (trentasei) mesi dalla data di produzione. La Garanzia risulterà efficace e vincolante per COMUNELLO solo se il prodotto verrà correttamente montato e mantenuto in conformità alle regole di installazione e di sicurezza indicate nella documentazione fornita da COMUNELLO o comunque rinvenibile sul sito www.comunello.com

8.4 La garanzia non comprende: avarie o danni causati dal trasporto; avarie o danni causati da vizi dell'impianto elettrico presente presso l'acquirente il prodotto e/o da trascuratezza, negligenza, inadeguatezza, uso anomalo di tale impianto; avarie o danni dovuti a manomissioni poste in essere da parte di personale non autorizzato o conseguenti allo scorretto uso/installazione (a questo proposito, si consiglia una manutenzione del sistema almeno ogni sei mesi) o all'impiego di pezzi di ricambio non originali; difetti causati da agenti chimici e/o fenomeni atmosferici. La garanzia non comprende il costo per materiale di consumo, in ogni caso COMUNELLO matura il credito per l'intervento eseguito presso il cliente, laddove quest'ultimo si riveli inutile poiché non risultava operante la garanzia o perché il cliente aveva utilizzato il prodotto COMUNELLO in modo negligente, imprudente od imperito, tale per cui il corretto utilizzo del prodotto avrebbe potuto evitare l'installazione.-

8.5 Termini attuativi: salvo diverso accordo, il diritto alla Garanzia Convenzionale si esercita esibendo copia del documento di acquisto (fattura fiscale) a COMUNELLO. Il Cliente deve denunciare il difetto a COMUNELLO entro il termine di decadenza di 30 (trenta) giorni dalla scoperta.

L'azione deve essere esercitata entro il termine di prescrizione di 6 (sei) mesi dalla scoperta. I pezzi dei Prodotti per i quali viene richiesta l'attivazione della Garanzia Convenzionale devono essere spediti dal Cliente presso FRATELLI COMUNELLO S.p.a., Via Cassola 64, 36027 Rosà (VI) Italia.

8.6 Il Cliente non potrà richiedere il risarcimento di danni indiretti, mancati profitti, perdita di produzione ed in ogni caso non potrà pretendere a titolo di risarcimento somme superiori al valore dei componenti o dei Prodotti forniti. Tutte le spese per il trasporto dei Prodotti da riparare o riparati, anche se coperti dalla Garanzia Convenzionale, sono a carico del Cliente.

8.7 Nessun intervento esterno effettuato dal personale tecnico di COMUNELLO è coperto dalla Garanzia Convenzionale.

8.8 Modifiche specifiche delle condizioni della Garanzia Convenzionale qui descritte possono essere definite dalle parti nei propri contratti commerciali.

9. RIPARAZIONI OLTRE IL TERMINE DI GARANZIA

9.1 Le riparazioni dei Prodotti richieste dal Cliente verranno effettuate da FRATELLI COMUNELLO SPA, previo accordo sul costo dell'intervento. In ogni caso le spese per la manodopera e quelle di spedizione (andata e ritorno) rimarranno a carico del Cliente.

10. RISERVA DI PROPRIETÀ

10.1 I Prodotti forniti al CLIENTE, rimangono di proprietà di FRATELLI COMUNELLO SPA fino al saldo integrale del Prezzo da parte del Cliente, indipendentemente da chi abbia la detenzione dei Prodotti. Le spese di trasporto e le altre necessarie al recupero dei Prodotti così come le spese straordinarie e quelle ripetibili, saranno a carico del Cliente.

11. BREVETTI, MARCHI E SEGNI DISTINTIVI

11.1 Il Cliente è a conoscenza del fatto che i Prodotti sono coperti da brevetti e sono oggetto di Know-How e design costituenti proprietà esclusiva di FRATELLI COMUNELLO SPA, a norma del Codice della Proprietà Industriale.

11.2 E' fatto espresso divieto al Cliente di violare tali diritti di FRATELLI COMUNELLO SPA ed in ogni caso il Cliente non potrà in alcun modo rimuovere, sopprimere o comunque alterare marchi ed altri segni distintivi o sigle di qualsiasi genere apposti ai Prodotti, così come è fatto divieto di apporne di nuovi di qualsiasi natura. E' vietata inoltre qualsiasi forma di riproduzione od utilizzo del marchio FRATELLI COMUNELLO SPA e di ogni altro segno distintivo presente sui Prodotti, salvo autorizzazione scritta di FRATELLI COMUNELLO SPA.

12. CLAUSOLA RISOLUTIVA ESPRESSA

12.1 Ai sensi e per gli effetti dell'articolo 1456 del Codice Civile, il ritardato pagamento superiore ai dieci giorni, o il mancato pagamento, anche solo parziale, del Prezzo da parte del Cliente, secondo le modalità di cui all'articolo 6 delle presenti Condizioni Generali di Vendita, comporterà la risoluzione del contratto di acquisto, con diritto per FRATELLI COMUNELLO SPA di chiedere al Cliente il risarcimento dei danni patiti, oltre alla restituzione dei Prodotti rispetto ai quali il Cliente non abbia pagato il Prezzo.

12.2 La comunicazione di cui al punto precedente sarà trasmessa tramite raccomandata A.R. o tramite Pec.

13. ACCORDI TRA LE PARTI

13.1 In caso di accordi, preesistenti o sopravvenuti, tra FRATELLI COMUNELLO SPA ed il Cliente, in relazione a resi e modalità di pagamento, tali accordi prevarranno su quanto a riguardo stabilito dalle Condizioni Generali di Vendita.

14. LEGGE APPLICABILE E FORO COMPETENTE

14.1 I contratti di acquisto conclusi secondo le Condizioni Generali di Vendita sono soggetti esclusivamente alla legge italiana, con esclusione di qualsiasi altra legislazione.

14.2 Tutte le controversie che dovessero sorgere in merito ai suddetti contratti d'acquisto saranno assoggettate alla giurisdizione italiana e rimesse alla competenza esclusiva del Tribunale di Vicenza, anche se il pagamento sia convenuto a mezzo ricevuta bancaria o tratta domiciliata presso il Cliente. (Italia). Il contenuto di questo catalogo è da ritenersi suscettibile di modifica in qualsiasi momento e senza obbligo di preavviso da parte di Fratelli Comunello SPA.

GENERAL TERMS OF SALE

1. GENERAL INFORMATION

1.1 This document is intended for customers (hereinafter "Customers") of FRATELLI COMUNELLO SPA (hereinafter simply COMUNELLO); its purpose is to inform customers about the contractual conditions that COMUNELLO shall apply in all the sales of its products (hereinafter GENERAL TERMS AND CONDITIONS OF SALE), unless otherwise agreed in writing, and which, in any case, are binding on and effective between the parties pursuant to art. 1341 of the Italian Civil Code.

1.2. COMUNELLO applies the Italian law in all contractual relationships involving the sale of its products, save for any specific derogations to be agreed and proved in writing.

1.3 The General Terms and Conditions of Sale listed here exclusively refer to products bearing the COMUNELLO trademark (hereinafter the "Products").

2. OFFERS – QUOTES

2.1 The offers made by COMUNELLO to its Customers are effective for a maximum period of 20 (twenty) days from their submission; in any case they will have to be formalized in writing, including by email.

2.2. Upon expiry of the aforementioned deadline, the offer made by COMUNELLO shall be deemed cancelled and not acceptable by the CUSTOMER, unless otherwise specifically agreed in writing between the contracting parties

3. ORDERS

3.1 Purchase orders signed by the Customers and addressed to Comunello must be confirmed using the specific form prepared by Comunello (order confirmation), which each Customer has to sign and return to Comunello, precisely specifying the quantity of the goods bought and any additional features of the requested products.

3.2 The purchase contract shall be considered finalized and binding on the parties by means of:

- a) confirmation of the purchase order by FRATELLI COMUNELLO SPA;
- b) physical execution of the purchase order by FRATELLI COMUNELLO SPA, provided it is in compliance with the contents of the sale entered into between the parties.

3.3 Any amendment or addition to the individual provisions of the General Terms and Conditions of Sale or to the purchase order shall be ineffective unless approved in writing by COMUNELLO SPA. In the event changes are made to the purchase order after sending the form specified in paragraph 3.1., they shall have no effect if in the meantime Comunello has accepted the order or has implemented it in part; in any event, Comunello reserves the right to cancel the original purchase order and to suspend performance of the current one, requesting damages.

3.4 The Product delivery date specified in the purchase orders is always indicative and any delay of up to 30 days with respect to such deadline shall never constitute grounds for the CUSTOMER to claim damages against Comunello or to terminate the contractual relationship.

More specifically, Comunello reserves the right to extend the delivery date due to unforeseeable circumstances or force majeure or in any case for circumstances that could not be foreseen at the time of the sale (for example, difficulty in procurement of raw materials and components); if prior to delivery, the CUSTOMER is in a difficult financial situation or changes its legal form, Comunello shall be entitled to suspend performance of, and possibly terminate the contract.

4. DELIVERY AND SHIPPING

4.1 The Products are delivered to the Customer at the production site or at the registered office of Comunello (hereinafter "Delivery").

4.2 If the Products are delivered Ex-works Rosà or Cassola (VI) Incoterms 2010, the risk is transferred upon delivery of the Products by FRATELLI COMUNELLO SPA to the Customer or to the carrier, the CUSTOMER being in charge of the transportation costs.

4.3 Unless otherwise agreed, FRATELLI COMUNELLO SPA shall establish, in the name and on behalf of the Customer, the type of shipment, the transport route and the carrier.

4.4 FRATELLI COMUNELLO SPA reserves the right to partially fulfil the purchase order or to partially deliver the products ordered. The Customer cannot raise any objection with regard to partial deliveries and/or deliveries made by instalments. All Partial deliveries shall be invoiced individually and the payment time limits shall run from the date of each invoice. The payment of partial Deliveries may not be deferred until completion of all the Deliveries related to the original purchase order. The provisions of Article 4.1 shall also apply to partial deliveries.

5. PRICES AND PRICE LISTS

5.1 The price is as specified in the last Comunello price list for the products delivered to the Customer, including normal packaging and excluding shipping costs (hereinafter the "Price"). The last price list issued by FRATELLI COMUNELLO SPA cancels all previous price lists and, unless otherwise agreed, it shall be applicable to the sale.

6. PAYMENT

6.1 Payment of the Price has to be made within the time limit agreed between the contracting parties. Failure to pay the price within the agreed time limit shall result in the application of interest for late payment in commercial transactions, to the extent provided by Legislative Decree No. 231 of 9.10.2002 as amended and supplemented. Default interest shall run from the expiry of the payment due date, subject to COMUNELLO's right to seek compensation for any further damage.

6.2 The Customer may not make claims or raise objections against Comunello until the Price has been paid.

6.3 In the event of irregular payments, Comunello reserves the right to suspend the performance of all purchase orders, including those not affected by the delay or default by the CUSTOMER, without notice and with no right to compensation for the CUSTOMER.

7. RETURNS AND COMPLAINTS

7.1 Any complaints referring to either the quantity or the quality of the delivered Products must be made in writing within 8 (eight) days from receipt of the Products.

7.2 The Products returned shall be accepted by FRATELLI COMUNELLO SPA only after written agreement and exclusively with regard to new Products with their original packaging.

7.3 The Products must be returned using the appropriate transport document specifying the written permission of FRATELLI COMUNELLO SPA as well as the quantity and quality of the Products.

7.4 Returns shall not be considered accepted by FRATELLI COMUNELLO SPA unless they are returned in the manner specified above and, specifically, taking delivery of the Products at the headquarters or at the warehouses of FRATELLI COMUNELLO SPA may not be construed as acceptance of the returns.

7.5 The amount credited for returns not due to causes attributable to FRATELLI COMUNELLO SPA, shall be subject to a 30% deduction, to be regarded as a flat-rate assessment of the damage (penalty clause), charged to the Customer on account of the general, shipping, goods deterioration, age etc. costs incurred

by COMUNELLO.

8. WARRANTY

8.1 In business relationships or in case of products sold for professional use, this warranty is limited to the repair or replacement of product parts that FRATELLI COMUNELLO SPA acknowledges as defective, through equivalent re-manufactured Products (the "Conventional Warranty"); the warranty does not include the costs necessary for repairing or replacing the material (e.g. labour costs, rental of equipment etc) .-

8.2 The provisions contained in articles 1490 to 1495 of the Italian Civil Code shall not apply.

8.3 FRATELLI COMUNELLO SPA warrants the proper operation of the products within the limits indicated in 8.1 above. Unless otherwise agreed, the validity of the Conventional Warranty is 24 (twenty four) months from the production date, which can be found on the products. For actuators of the Showin line the warranty is 60 (sixty) months from the production date, while for the remaining products of the Automation Frame Line the warranty is 36 (thirty six) months from the production date. The Warranty shall be effective and binding on COMUNELLO only if the product has been correctly installed and maintained in accordance with the installation and safety rules set out in the documentation provided by COMUNELLO or otherwise available on the website www.comunello.com

8.4 The warranty does not cover: failures or damage caused by transport; failures or damage caused by defects in the electrical system of the buyer and/or by carelessness, negligence, inadequate or abnormal use of such system; failure or damage due to tampering carried out by unauthorized personnel or due to incorrect use / installation (in this regard, system maintenance at least every six months is recommended) or the use of non-original spare parts; defects caused by chemical agents and/or atmospheric phenomena. The warranty does not cover the cost

of consumables; in any event, COMUNELLO shall be entitled to a consideration for the work performed at the Customer, where such work proves useless as the warranty did not apply or because the customer had used the Comunello product in a negligent, reckless or incompetent manner, such that the proper use of the product could have avoided the work.

8.5 Implementation terms: unless otherwise agreed, the right to the Conventional Warranty is exercised by showing a copy of the purchase document (invoice) to COMUNELLO. Any defect must be notified to COMUNELLO within the time limit of thirty (30) days from detection of the defect.

The action must be exercised within the limitation period of 6 (six) months from detection of the defect. The Product parts for which the Customer requests application of the Conventional Warranty must be returned by the Customer to FRATELLI COMUNELLO SPA, Via Cassola 64, 36027 Rosà (VI) Italy.

8.6 The Customer cannot claim compensation for indirect damage, loss of profits, loss of production and in any case it cannot claim compensation for an amount that exceeds the value of the supplied components or products. All transport costs for Products that have been repaired or to be repaired, although covered by the Conventional Warranty, shall be charged to the Customer.

8.7 No external work carried out by Comunello technical staff is covered by the Conventional Warranty.

8.8 Specific amendments to the Conventional Warranty conditions described herein can be defined by the parties in their commercial contracts.

9. REPAIRS AFTER EXPIRATION OF THE WARRANTY

9.1 The Product repairs requested by the Customer shall be carried out by FRATELLI COMUNELLO SPA, subject to prior agreement on the cost of the work. In any case, labour and transport costs (return) shall be charged to the customer.

10. RESERVATION OF TITLE

10.1 The Products delivered to the CUSTOMER shall continue to be the property of FRATELLI COMUNELLO SPA until full payment of the Price by the Customer, regardless of who has possession of the Products. Transport costs and other costs necessary to recover the Products as well as extraordinary expenses and those that can be recovered, shall be charged to the Customer.

11. PATENTS, TRADEMARKS AND DISTINCTIVE MARKS

11.1 The Customer is aware that the Products are covered by patents and incorporate know-how and design that are the exclusive property of FRATELLI COMUNELLO SPA, pursuant to the Italian Industrial Property Code.

11.2 The Customer is expressly forbidden from infringing such FRATELLI COMUNELLO SPA's rights; in any case, the Customer may not in any way remove, delete or otherwise alter the trademarks or other signs or distinctive marks of any kind affixed to Products; the Customer is likewise forbidden from affixing new ones of any kind. Any form of reproduction or use of the FRATELLI COMUNELLO SPA trademark and of any other distinctive mark on the Products is forbidden, without written authorization by FRATELLI COMUNELLO SPA.

12. EXPRESS TERMINATION CLAUSE

12.1 Pursuant to article 1456 of the Italian Civil Code, any delay of more than ten days in the payment, or any non-payment of the Price, including partial, by the Client, as provided for in Article 6 of these General Terms and Conditions of Sale, shall result in termination of the purchase contract and FRATELLI COMUNELLO SPA shall be entitled to seek compensation from the Customer for the damage suffered, in addition to restitution of the Products not paid by the Customer.

12.2 The notice referred to in the previous paragraph shall be sent by registered mail with return receipt or via certified email address (Pec).

13. AGREEMENT BETWEEN THE PARTIES

13.1 Any agreements, existing or that will take place between FRATELLI COMUNELLO SPA and the Customer, in relation to returns and payment methods, shall prevail over the provisions of these General Terms and Conditions of Sale.

14. APPLICABLE LAW AND JURISDICTION

14.1 The purchase contracts entered into in accordance with the General Terms and Conditions of Sale are subject to Italian law only, with the exclusion of any other legislation.

14.2 All disputes that may arise on the mentioned purchase contracts shall be subject to Italian jurisdiction and referred to the exclusive competence of the Court of Vicenza, including if the agreed payment method is by bank collection order or draft payable at the customer's. (Italy). The content of this catalogue is subject to change at any time and without notice by FRATELLI COMUNELLO SPA.

Le immagini, i disegni tecnici e le relative specifiche appartengono a Fratelli Comunello SpA e sono protetti dalle leggi sul copyright. Ogni utilizzo non espressamente autorizzato sarà perseguito legalmente. Le specifiche dei prodotti sono soggette a cambiamenti senza preavviso. Possono essere richiesti su specifiche del cliente articoli con altre misure oppure a disegno. Foto immagini e disegni sono puramente indicativi. Fratelli Comunello SpA si riserva il diritto di apportare qualsiasi tipo di variazione, anche senza preavviso, al fine di aggiornare e migliorare il catalogo in qualsiasi momento. Fratelli Comunello SpA non risponde per eventuali errori tipografici o descrizioni errate di prodotti e caratteristiche tecniche.

All images, technical drawings and specifications are the exclusive property of Fratelli Comunello SpA and are protected by International Copyright laws. Any unauthorised use will result in legal proceedings. Fratelli Comunello SpA reserves the right to alter technical specifications at any time without notice. Clients may request bespoke products of different sizes and/or based on customised designs. All photographs and other images shown are for informational purposes only. Fratelli Comunello SpA reserves the right to make any kind of alteration, at any time and without prior notice so as to update and improve the catalogue. Fratelli Comunello SpA is not liable for any errors or other mistakes in the technical descriptions and technical characteristics of the products shown.

HELP DESK **+39 0424 585 111**

CONSULENZA TECNICA IN CANTIERE
PROFESSIONAL ON-SITE TECHNICAL SERVICE

TECHNICAL INFORMATION
www.comunello.com

FRATELLI COMUNELLO S.P.A.

Via Cassola, 64 - C.P. 79

36027 Rosà, Vicenza, Italy

Tel. +39 0424 585111 Fax +39 0424 533417

info@comunello.it www.comunello.com





MADE IN ITALY



COMUNELLO



