

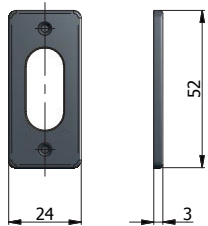

BORCHIE	
ROSES	PAG.284
ACCESSORI PER ELETTROSERRATURE	
ACCESSORIES FOR ELECTRIC LOCKS	PAG.285
ACCESSORI VARI	
SUNDRY ACCESSORIES	PAG.286

BORCHIA
ROSE



Per cilindri ovali
For oval cylinders

COD.	Materiale - Material	kg		
0140 N	Nylon nero -Black nylon	0,002	100	-

COPPIA BORCHIE GUIDA CHIAVE (CON VITI)
PAIR OF KEY GUIDE ESCUTCHEON (WITH SCREWS)

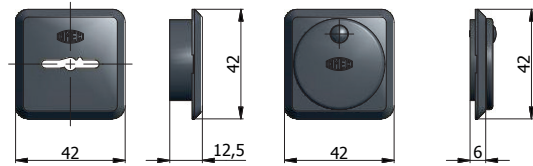

Per serrature a doppia mappa
For double-bit key locks

COD.	Materiale - Material	kg		
0590 N	Nylon nero -Black nylon	0,040	10	-

BORCHIA
ROSE

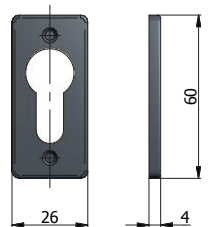

Per cilindri sagomati
For profile cylinders

COD.	Materiale - Material	kg		
0120 N	Nylon nero -Black nylon	0,004	100	-

BORCHIA GUIDA CHIAVE
KEY GUIDE ESCUTCHEON

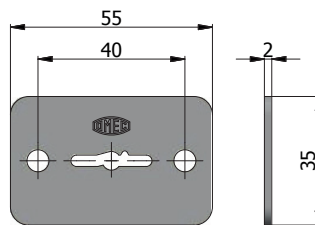

Per serrature a doppia mappa
For double-bit key locks

COD.	Materiale - Material	kg		
0590 A	Acciaio zincato - Zinc-plated steel	0,040	50	-

BORCHIA GUIDA CHIAVE (CON VITI)
KEY GUIDE ESCUTCHEON (WITH SCREWS)

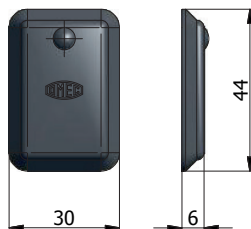

Per serrature con cilindro a spillo
For cross key locks

COD.	Materiale - Material	kg		
0440 N	Nylon nero -Black nylon	0,010	50	-

BORCHIA GUIDA CHIAVE
KEY GUIDE ROSE

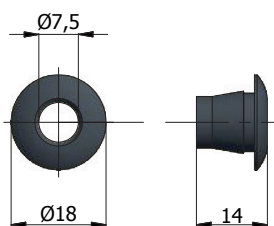

Per serrature con cilindro a spillo
For cross key locks

COD.	Materiale - Material	kg		
0441 N	Nylon nero -Black nylon	0,001	100	-

COPPIA CONTATTI (CON SPESSORI)
PAIR OF CONTACTS (WITH SPACERS)

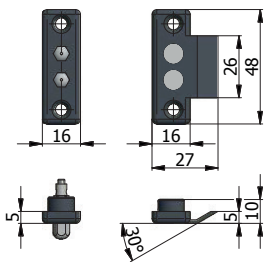

Per elettroserrature
For electric locks

COD.	Caratteristiche elettriche Electrical features	kg		
050	12V - 1,5A	0,030	10	-

PULSANTE MECCANICO DI APERTURA (CON VITI)
MECHANICAL PUSH-BUTTON (WITH SCREWS)

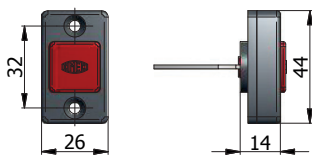

Per elettroserrature
predisposte
For predisposed electric
locks

COD.	Materiale - Material	kg		
058	Nylon	0,030	10	-

PULSANTE MECCANICO DI APERTURA (CON VITI)
MECHANICAL PUSH-BUTTON (WITH SCREWS)

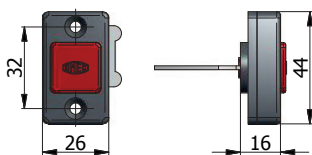

CON FERMO A GIORNO
HOLD-OPEN
Per elettroserrature
predisposte
For predisposed electric
locks

COD.	Materiale - Material	kg		
059	Nylon	0,030	10	-

GRUPPO BOBINE
COIL SET

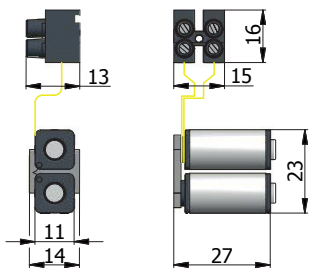

Per elettroserrature serie
For electric locks series
1777-377-378-777-778-
877-878

COD.	Caratteristiche elettriche Electrical features	kg		
033	12V - 15W a.c.	0,031	10	-

GRUPPO BOBINE CON BLOCCHETTO ANTISTRAPPO
TEAR RESISTANT COIL SET

NEW

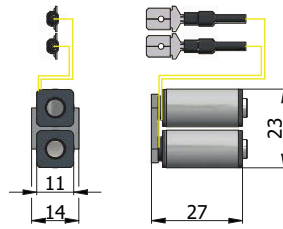

Per elettroserrature serie
For electric locks series
388-399-788-799-888-
899-999

Sostituisce cod. 034 - Replaces cod. 034

COD.	Caratteristiche elettriche Electrical features	kg		
035	12V - 15W a.c.	0,030	10	-

BOBINA CON BLOCCHETTO ANTISTRAPPO
TEAR RESISTANT COIL SET

NEW

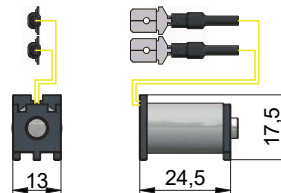

Per elettroserrature serie
For electric locks series
1408Q-1409Q-1418Q
1508Q
4408Q-4409Q-4418Q

Sostituisce cod. 037 - Replaces cod. 037

COD.	Caratteristiche elettriche Electrical features	kg		
039Q	12V - 10W a.c. / d.c.	0,021	10	-

BOBINA CON BLOCCHETTO ANTISTRAPPO
TEAR RESISTANT COIL SET

NEW

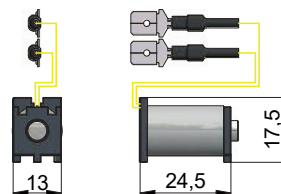

Per elettroserrature serie
For electric locks series
1408-1409-1418
1508
4408-4409-4418

Sostituisce cod. 038 - Replaces cod. 038

COD.	Caratteristiche elettriche Electrical features	kg		
039	12V - 10W a.c. / d.c.	0,021	10	-



BOBINA
COIL SET

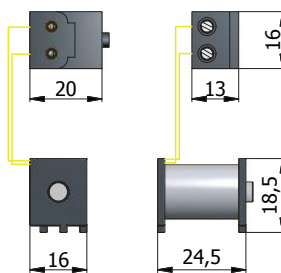

Per elettroserrature serie
For electric locks series
5938-5948-5968-5978

COD.	Caratteristiche elettriche Electrical features	kg		
048	12V - 10W a.c.	0,030	10	-

ACCESSORI VARI SUNDRY ACCESSORIES

ASTA INTERNA INTERNAL ROD

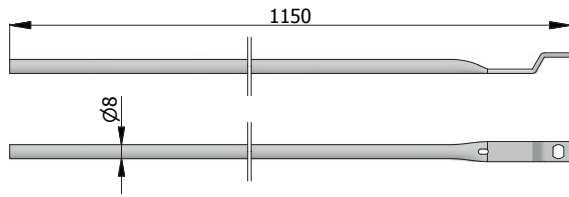

Per kit serie - For kit series

0670-0670E

COD.	Materiale - Material	kg		
AST001	Acciaio zincato Zinc-plated steel	0,196	10	-

PIASTRINA DI COLLEGAMENTO CONNECTING PLATE

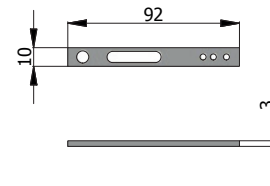

Per kit serie - For kit series

0671-0671E-0682-0682S-0691-0692-0772S-0782S

COD.	Materiale - Material	kg		
PSR028	Acciaio zincato Zinc-plated steel	0,160	50	-

ASTA INTERNA INTERNAL ROD

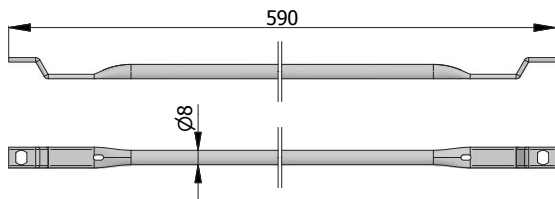

Per kit serie - For kit series

0680-0680S-0690-0770S-0780S

COD.	Materiale - Material	kg		
AST002	Acciaio zincato Zinc-plated steel	0,100	10	-

PROLUNGA PIN JOINT

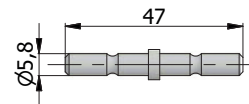

Per kit serie - For kit series

0670-0670E-0690

COD.	Materiale - Material	kg		
PR5070	Acciaio zincato Zinc-plated steel	0,010	50	-

ASTA ESTERNA EXTERNAL ROD

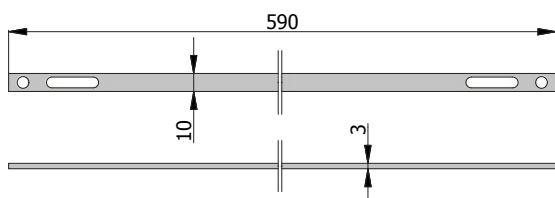

Per kit serie - For kit series

0681-0681S-0691-0771S-0781S

COD.	Materiale - Material	kg		
AST003	Acciaio zincato Zinc-plated steel	0,126	10	-

PUNTALE ANTISEGA STEEL SAW-RESISTANT TIP

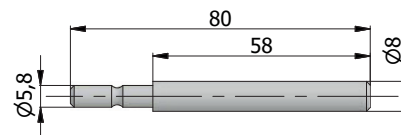

Per kit serie - For kit series

0670-0670E-0690

COD.	Materiale - Material	kg		
067D08	Acciaio cementato e zincato Hardened and zinc-plated steel	0,027	50	-

PINZA GUIDA ASTA
ROD GUIDE

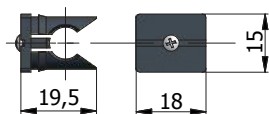

Per kit serie - For kit series

0670-0670E-0680-0680S-0690-0770S-0780S

COD.	Materiale - Material	kg		
ANY031	Nylon nero Black nylon	0,003	50	-

BOCCOLA ANTIPOLVERE A PAVIMENTO
SPRUNG DUST FLOOR STRIKER

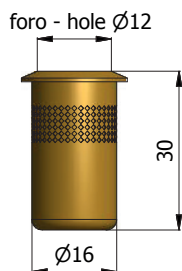

Per kit serie - For kit series

0670-0671-0674-0690-0691-0692-0699

COD.	Materiale - Material	kg		
0630 T	Ottone - Brass	0,020	10	-

BOCCOLA
BUSHING

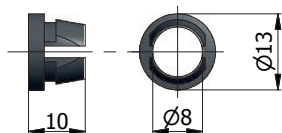

Per kit serie - For kit series

0670-0670E-0690

COD.	Materiale - Material	kg		
ANY032	Nylon nero Black nylon	0,001	100	-

BOCCOLA
BUSHING

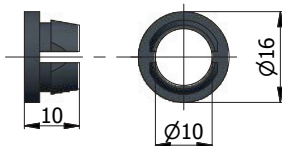

Per kit serie - For kit series

0670-0670E-0690

COD.	Materiale - Material	kg		
ANY033	Nylon nero - Black nylon	0,001	100	-

VITE CILINDRO
CYLINDER SCREW

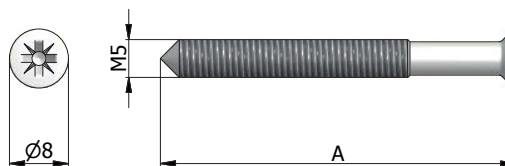

Per cilindri

For cylinders

COD.	A	Materiale - Material	kg		
VTC001	22	Acciaio nichelato - Nickel-plated steel	0,002	100	-
VTC002	27	Acciaio nichelato - Nickel-plated steel	0,003	100	-
VTC003	37	Acciaio nichelato - Nickel-plated steel	0,004	100	-
VTC004	47	Acciaio nichelato - Nickel-plated steel	0,006	100	-
VTC006	67	Acciaio nichelato - Nickel-plated steel	0,008	100	-
VTC007	77	Acciaio nichelato - Nickel-plated steel	0,009	100	-
VTC008	87	Acciaio nichelato - Nickel-plated steel	0,010	100	-
VTC009	97	Acciaio nichelato - Nickel-plated steel	0,011	100	-
VTC011	117	Acciaio nichelato - Nickel-plated steel	0,014	100	-

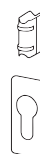

DEVIATORE BASCULANTE PER 3 PUNTI DI CHIUSURA
3 LOCKING POINTS TIPPING DEVIATOR

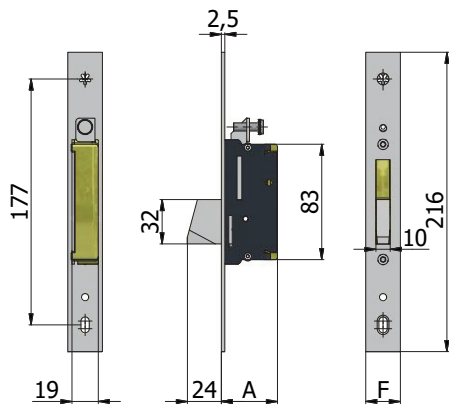

Per kit serie - For kits series 0680-0681-0682-0689

COD.	F	A			
0661	25	40,5	0,340	2	-

DEVIATORE BASCULANTE PER 5 PUNTI DI CHIUSURA
5 LOCKING POINTS TIPPING DEVIATOR

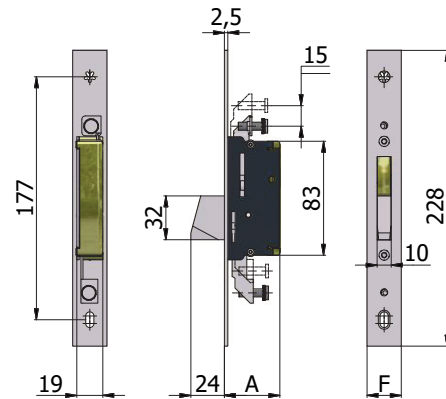

Per kit serie - For kits series 0690-0691-0692-0699

COD.	F	A			
0662	25	40,5	0,400	2	-

DEVIATORE BASCULANTE PER 3 PUNTI DI CHIUSURA
3 LOCKING POINTS TIPPING DEVIATOR

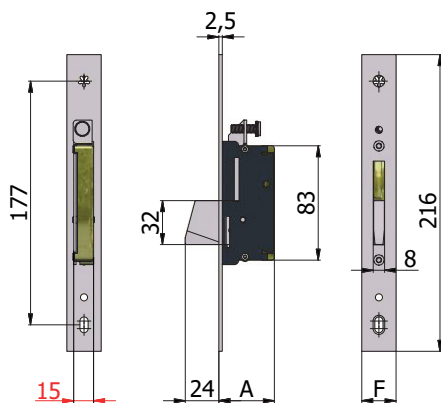

Per kit serie - For kits series 0680S-0681S-0682S-0689S

COD.	F	A			
0661S	25	40,5	0,304	2	-
0661S/F16	16	40,5	0,259	2	-
0661S/F22	22	40,5	0,289	2	-

DEVIATORE AVANZANTE PER 3/5 PUNTI DI CHIUSURA
3/5 LOCKING POINTS ADVANCING DEVIATOR

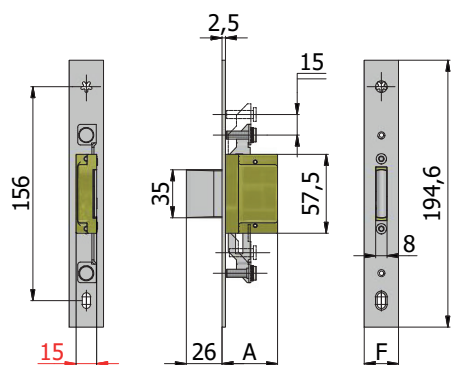

Per kit serie - For kits series 0780S-0781S-0782S-0789S

COD.	F	A			
0761S	25	41	0,277	2	-
0761S/F16	16	41	0,241	2	-
0761S/F22	22	41	0,265	2	-

DEVIATORE GANCIO E PISTONE PER 3/5 PUNTI DI CHIUSURA
3/5 LOCKING POINTS HOOK AND PISTON DEVIATOR

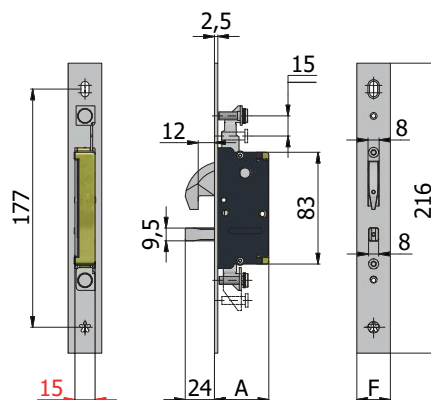

Per kit serie - For kits series 0770S-0771S-0772S-0779S

COD.	F	A			
0766S	25	40,5	0,345	2	-
0766S/F16	16	40,5	0,305	2	-
0766S/F22	22	40,5	0,332	2	-

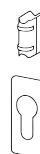

SCROCCO INTERCAMBIABILE ANTI-RUMORE
INTERCHANGEABLE ANTI-NOISE LATCH BOLT

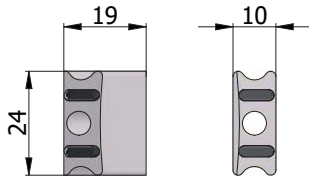

Per serrature serie
For locks series
1770
338-358
370
4338-4530
530-540
770-782-870-882

COD.	Materiale - Material			
0370	Lega speciale nichelata Nickel-plated special alloy	0,018	10	-

SCROCCO INTERCAMBIABILE ANTI-RUMORE
INTERCHANGEABLE ANTI-NOISE LATCH BOLT

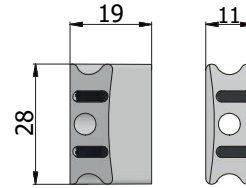

Per serrature serie:
For locks series:
1300
1400-1400S-1408Q-1409Q
1410-1410S-1418Q-1490
1500-1500S-1508Q
1600S-1610S-1620S-1630S
1700S-1720S-1740S-1760S
3400-3410-3500
4400-4408Q-4409Q
4410-4418Q-4490

COD.	Materiale - Material			
014305	Lega speciale nichelata Nickel-plated special alloy	0,024	10	-

SCROCCO INTERCAMBIABILE ANTI-RUMORE
INTERCHANGEABLE ANTI-NOISE LATCH BOLT

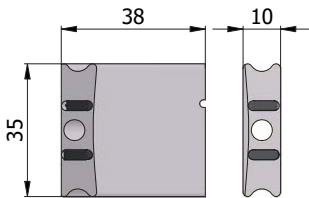

Per serrature serie
For locks series
1780-380-780-880

COD.	Materiale - Material			
0380	Lega speciale nichelata Nickel-plated special alloy	0,058	10	-

RULLO INTERCAMBIABILE
INTERCHANGEABLE ROLLER BOLT

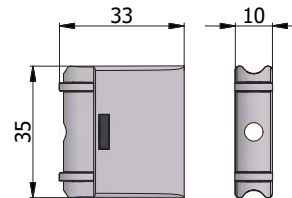

Per serrature serie
For locks series
1780-380-780-880

COD.	Materiale - Material			
0385	Ottone nichelato Nickel-plated brass	0,050	10	-

SCROCCO INTERCAMBIABILE ANTI-RUMORE
INTERCHANGEABLE ANTI-NOISE LATCH BOLT

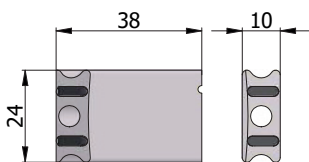

Per serrature serie
For locks series
390-790-890-990

COD.	Materiale - Material			
0390	Lega speciale nichelata Nickel-plated special alloy	0,037	10	-

RULLO INTERCAMBIABILE
INTERCHANGEABLE ROLLER BOLT

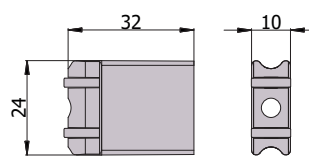

Per serrature serie
For locks series
390-790-890-990

COD.	Materiale - Material			
0395	Ottone nichelato Nickel-plated brass	0,032	10	-

SCROCCO INTERCAMBIABILE
INTERCHANGEABLE LATCH BOLT

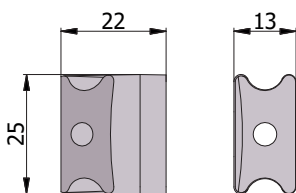

Per serrature serie
For locks series
11140-11170
1940-1970
41140-41170-4940-4970
5930-5940-5960-5970

COD.	Materiale - Material			
05930	Lega speciale nichelata Nickel-plated special alloy	0,026	10	-

RULLO INTERCAMBIABILE
INTERCHANGEABLE ROLLER BOLT

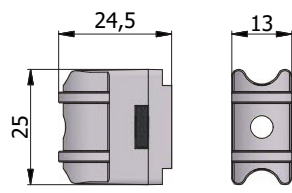

Per serrature serie
For locks series
11140-11170
1940-1970
41140-41170-4940-4970
5930-5940-5960-5970

COD.	Materiale - Material			
05935	Ottone nichelato Nickel-plated brass	0,032	10	-

RULLO INTERCambiabile
INTERCHANGEABLE ROLLER BOLT

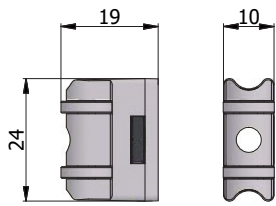

Per serrature serie
For locks series
1770
338-358
370
4338-4530
530-540
770-782-870-882

COD.	Materiale - Material	kg	10	-
0535	Ottone nichelato Nickel-plated brass	0,018	10	-

TAPPO
PLUG

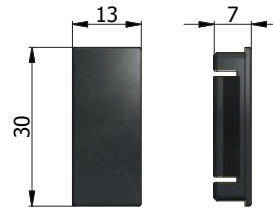

Per serrature serie:
For locks series:
1300
1400-1400S-1410-1410S-1490
1500-1500S
1600S-1610S-1620S-1630S
1700S-1720S-1740S-1760S
3400-3410-3500
4400-4410-4490

COD.	Materiale - Material	kg	10	-
01431	Nylon nero - Black nylon	0,002	10	-

RULLO INTERCambiabile (CON MOLLE)
INTERCHANGEABLE ROLLER BOLT (WITH SPRINGS)

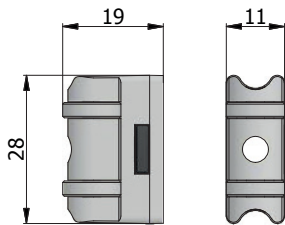

Per serrature serie:
For locks series:
1300
1400-1400S-1410-1410S-1490
1500-1500S
1600S-1610S-1620S-1630S
1700S-1720S-1740S-1760S
3400-3410-3500
4400-4410-4490

COD.	Materiale - Material	kg	10	-
01435	Ottone nichelato Nickel-plated brass	0,026	10	-

SOTTOFRONTALE
FOREND SPACER

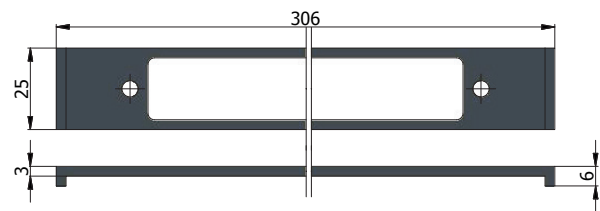

Per serrature di sicurezza per montanti con frontale 25 mm
For vertical security locks with 25 mm forend

COD.	Materiale - Material	kg	50	-
0623 N	Nylon nero - Black nylon	0,007	50	-

TAPPO
PLUG

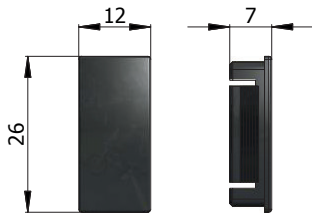

Per serrature serie
For locks series
1770-370-770-870

COD.	Materiale - Material	kg	10	-
0371	Nylon nero - Black nylon	0,002	10	-

SOTTOFRONTALE
FOREND SPACER

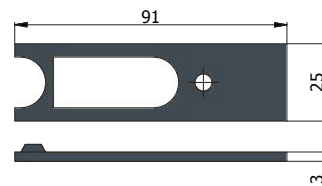

Per serrature di sicurezza e a doppia mappa per fasce con frontale 25 mm
For horizontal security and double-bit key locks with 25 mm forend

COD.	Materiale - Material	kg	50	-
0624 N	Nylon nero - Black nylon	0,004	50	-

TAPPO
PLUG

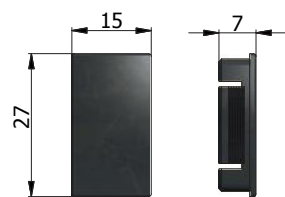

Per serrature serie
For locks series
11140-11170
1940-1970
41140-41170-4940-4970
5930-5940-5960-5970

COD.	Materiale - Material	kg	10	-
05931	Nylon nero - Black nylon	0,002	10	-

SOTTOFRONTALE
FOREND SPACER

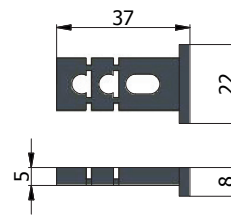

Per serrature con frontale 22 mm
For locks with 22 mm forend

COD.	Materiale - Material	kg	50	-
0625 N	Nylon nero - Black nylon	0,002	50	-



SOTTOFRONTALE
FOREND SPACER

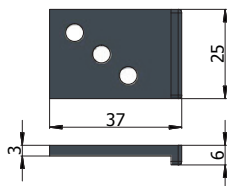

Per serrature cod.
For locks cod.
1408Q-1409Q-1418Q
4408Q-4409Q-4418Q

COD.	Materiale - Material			
0626 N	Nylon nero - Black nylon	0,003	50	-

SOTTOFRONTALE
FOREND SPACER

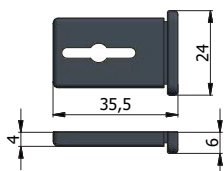

Per serrature multipunto con frontale a U
For multi-point locks with U forend

COD.	Materiale - Material			
0633 N	Nylon nero - Black nylon	0,003	50	-

SOTTOFRONTALE
FOREND SPACER

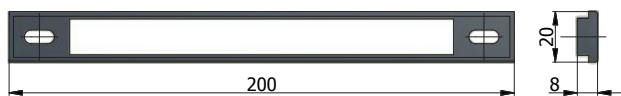

Per serrature con frontale 16 mm cod.
For locks with 16 mm forend cod.
320-322-328-330-332-338-340-342-348-350-352-358-4320-4328-4330
4338-4340-4350-4530-4535-530-535-540-545

COD.	Materiale - Material			
0720 N	Nylon nero - Black nylon	0,012	50	-

SOTTOFRONTALE
FOREND SPACER



Per serrature per fasce con frontale 16 mm e per montanti cod.
For horizontal locks with 16 mm forend and vertical locks cod.
327-334-335-337-339-345-351-354-355-356-357-359-4335-4339-4355
4356-4531-531-541

COD.	Materiale - Material			
0730 N	Nylon nero - Black nylon	0,010	50	-



