

CONTROPIASTRE PIANE	
FLAT STRIKING PLATES	PAG.310
CONTROPIASTRE IN NYLON	
NYLON STRIKING PLATES	PAG.316
CONTROPIASTRE IN METALLO	
METAL STRIKING PLATES	PAG.328
CONTROPIASTRE REGOLABILI IN ACCIAIO INOX	
STAINLESS STEEL ADJUSTABLE STRIKING PLATES	PAG.344

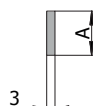

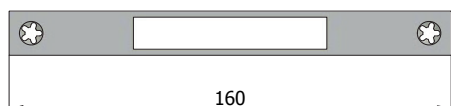

Per serrature serie - For locks series
1770 - 1775
370 - 375 - 378
770 - 775 - 778 - 782
870 - 875 - 878 - 882

COD.	A	Materiale - Material	kg		
01611 A	16	Acciaio cromato - Chrome-plated steel	0,033	50	-
02211 A	22	Acciaio cromato - Chrome-plated steel	0,054	50	-

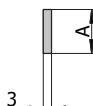
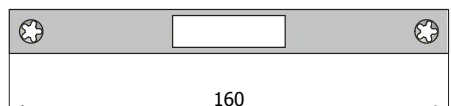

Per serrature serie - For locks series
1771 - 1777 - 1780 - 1781 - 1785
371 - 377 - 380 - 381 - 385 - 388 - 390 - 391 - 395
771 - 777 - 780 - 781 - 785 - 788 - 790 - 791 - 795
871 - 877 - 880 - 881 - 885 - 888 - 890 - 891 - 895
990 - 991 - 995

COD.	A	Materiale - Material	kg		
01613 A	16	Acciaio cromato - Chrome-plated steel	0,046	50	-
02213 A	22	Acciaio cromato - Chrome-plated steel	0,067	50	-

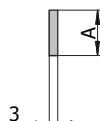
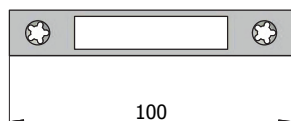

Per serrature serie - For locks series
1301
334 - 335 - 339 - 354 - 355 - 359
4335 - 4339 - 4355 - 4531
531 - 541

COD.	A	Materiale - Material	kg		
01614 A	16	Acciaio cromato - Chrome-plated steel	0,021	50	-
02214 A	22	Acciaio cromato - Chrome-plated steel	0,034	50	-

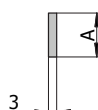
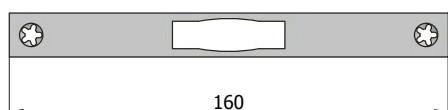

Per serrature serie - For locks series
345

COD.	A	Materiale - Material	kg		
01615 A	16	Acciaio cromato - Chrome-plated steel	0,046	50	-
02215 A	22	Acciaio cromato - Chrome-plated steel	0,048	50	-

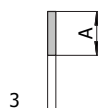
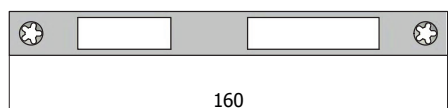

Per serrature serie - For locks series
1300 - 1305
328 - 330 - 332 - 338 - 348 - 350 - 352 - 358
4328 - 4330 - 4338 - 4350 - 4530 - 4535
530 - 535 - 540 - 545

COD.	A	Materiale - Material	kg		
01616 A	16	Acciaio cromato - Chrome-plated steel	0,036	50	-
02216 A	22	Acciaio cromato - Chrome-plated steel	0,048	50	-

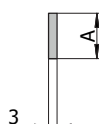
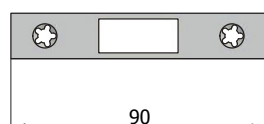

Per serrature serie - For locks series
1776
327 - 337 - 351 - 356 - 357
376 - 386 - 396 - 399
4356
776 - 786 - 796 - 799
899
999

COD.	A	Materiale - Material	kg		
01619 A	16	Acciaio cromato - Chrome-plated steel	0,024	50	-
02219 A	22	Acciaio cromato - Chrome-plated steel	0,038	50	-



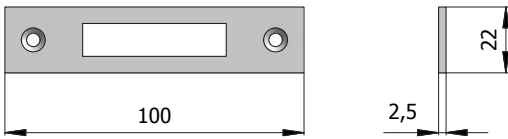

Per serrature serie - For locks series
4621/F20

COD.	Materiale - Material	kg		
02014 A	Acciaio nichelato - Nickel - plated steel	0,029	50	-

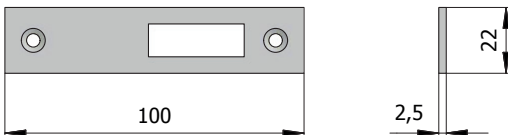

Per serrature serie - For locks series
4626/F20

COD.	Materiale - Material	kg		
02019 A	Acciaio nichelato - Nickel - plated steel	0,032	50	-

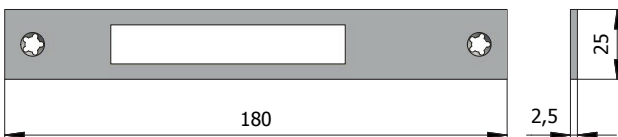

Per serrature serie - For locks series
11140 - 11141 - 11145 - 11170 - 11171 - 11175
1940 - 1941 - 1945 - 1970 - 1971 - 1975
41140 - 41141 - 41145 - 41170 - 41171 - 41175
4940 - 4941 - 4945 - 4970 - 4971 - 4975
5930 - 5931 - 5935 - 5938 - 5940 - 5941 - 5945 - 5948
5950 - 5951 - 5960 - 5961 - 5965 - 5968 - 5970 - 5971
5975 - 5978 - 5980 - 5981

COD.	Materiale - Material	kg		
02521 X	Acciaio inox - Stainless steel	0,062	50	-

CONTROPIASTRE PIANE
FLAT STRIKING PLATES

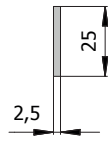
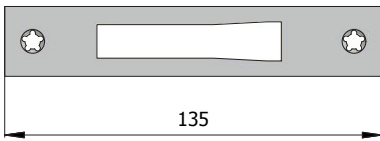

Per serrature serie - For locks series
1401 - 1406 - 1411 - 1416 - 1473 - 1491 - 1496
1501 - 1506 - 1531 - 1541
4401 - 4406 - 4411 - 4416 - 4473 - 4491 - 4496

Per deviatori serie - For deviators series
0661 - 0662

Per deviatori multipunto catenaccio basculante
For deviators of multi-point locks with tipping dead bolt

COD.	Materiale - Material	kg		
02524 X	Acciaio inox - Stainless steel	0,046	50	-

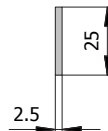
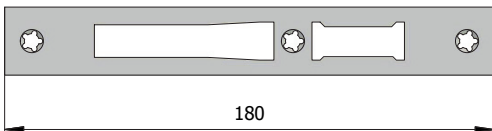

Per serrature serie - For locks series
1300 - 1305
1400 - 1405 - 1408Q - 1409Q - 1410 - 1415 - 1418Q
1490 - 1495
1500 - 1505 - 1508Q
4400 - 4405 - 4408Q - 4409Q - 4410 - 4415 - 4418Q
4490 - 4495

COD.	Materiale - Material	kg		
02526 X	Acciaio inox - Stainless steel	0,060	50	-

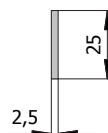
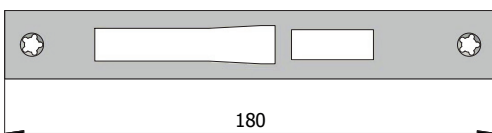

Per serrature serie - For locks series
1408 - 1409 - 1418
1508
4408 - 4409 - 4418

COD.	Materiale - Material	kg		
02528 X	Acciaio inox - Stainless steel	0,064	50	-



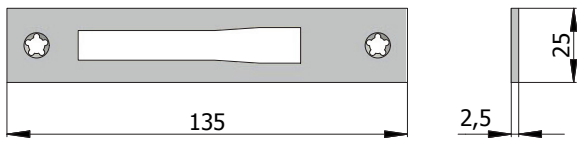

Per serrature serie - For locks series
1401S - 1411S
1501S
1601S - 1611S - 1621S - 1631S
1701S - 1721S - 1741S - 1761S

Per deviatori serie - For deviators series
0661S - 0761S

Per deviatori serrature multipunto ad ingranaggi
(tranne serie 1740S - 1760S)
For deviators of vertical multi-point locks with gear mechanism
movements (but series 1740S - 1760S)

COD.	Materiale - Material	kg		
02544 X	Acciaio inox - Stainless steel	0,051	50	-

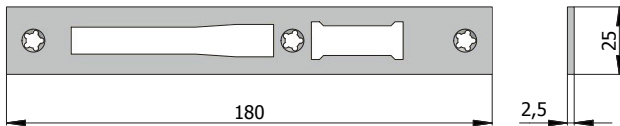

Per serrature serie - For locks series
1400S - 1405S - 1410S - 1415S
1500S - 1505S
1600S - 1605S - 1610S - 1615S
1620S - 1625S - 1630S - 1635S
1700S - 1705S - 1720S - 1725S
1740S - 1745S - 1760S - 1765S

COD.	Materiale - Material	kg		
02546 X	Acciaio inox - Stainless steel	0,065	50	-

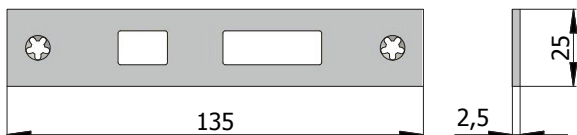

Per deviatori serie - For deviators series
0766S

NEW

Per deviatori multipunto serie - For multi-point deviators series
1740S - 1741S - 1745S - 1760S - 1761S - 1765S

COD.	Materiale - Material	kg		
02549 X	Acciaio inox - Stainless steel	0,051	50	-



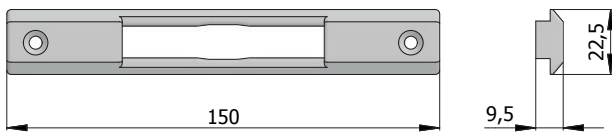

Per serrature serie - For locks series

- 1301
- 1770 - 1771 - 1777 - 1780 - 1781 - 1785
- 327 - 334 - 335 - 337 - 339 - 351 - 354 - 355 - 357 - 359
- 370 - 371 - 377 - 378 - 380 - 381 - 385 - 388
- 390 - 391 - 395 - 399
- 4335 - 4339 - 4355 - 4531
- 531 - 541
- 770 - 771 - 777 - 778 - 780 - 781 - 782 - 785 - 788
- 790 - 791 - 795 - 799
- 870 - 871 - 877 - 878 - 880 - 881 - 882 - 885 - 888
- 890 - 891 - 895 - 899
- 990 - 991 - 995 - 999

Per profili tipo - For profiles type
 Domal stopper PG Finestra
 NC 45 Int. Finestra

COD.	Materiale - Material			
02381 N	Nylon nero - Black nylon	0,011	20	-

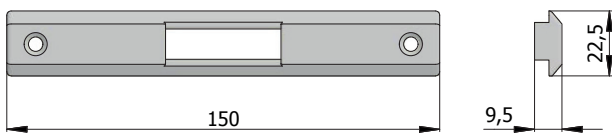

Per serrature serie - For locks series

- 1301
- 1771 - 1777
- 327 - 337 - 351 - 357
- 371 - 377 - 380 - 381 - 385 - 388 - 390 - 391 - 395 - 399
- 771 - 777 - 780 - 781 - 785 - 788 - 790 - 791 - 795 - 799
- 871 - 877 - 880 - 881 - 885 - 888 - 890 - 891 - 895 - 899
- 990 - 991 - 995 - 999

Per profili tipo - For profiles type
 Domal stopper PG Finestra
 NC 45 Int. Finestra

COD.	Materiale - Material			
02383 N	Nylon nero - Black nylon	0,014	20	-



Per serrature serie - For locks series

- 330 - 332 - 338 - 350 - 352 - 358
- 4330 - 4338 - 4350 - 4530
- 530 - 540

Per profili tipo - For profiles type
 Domal stopper PG Finestra
 NC 45 Int. Finestra

COD.	Materiale - Material			
02386 N	Nylon nero - Black nylon	0,011	20	-

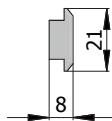
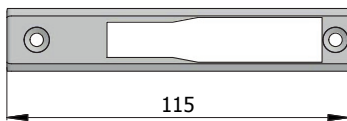

Per serrature serie - For locks series

- 11141 - 11171
- 1401 - 1401S - 1411 - 1411S
- 1501 - 1501S
- 1941 - 1971
- 41141 - 41171
- 4401 - 4411
- 4941 - 4971
- 5931 - 5941 - 5948 - 5951 - 5961 - 5971 - 5978 - 5981

Per deviatori serie - For deviators series

- 0661 - 0661S - 0662

Per deviatori multipunto catenaccio basculante

For deviators of multi-point locks with tipping dead bolt

Per profili tipo - For profiles type
 Domal stopper PG Finestra
 NC 45 Int. Finestra

COD.	Materiale - Material	kg		
02394 N	Nylon nero - Black nylon	0,008	20	-

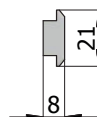
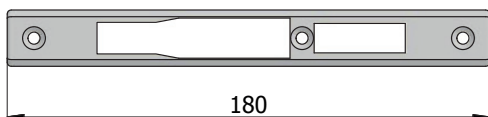

Per serrature serie - For locks series

- 1300 - 1305
- 1400 - 1400S - 1405 - 1405S - 1408Q - 1409Q - 1410 - 1410S - 1415 - 1415S - 1418Q
- 1500 - 1500S - 1505 - 1505S - 1508Q
- 4400 - 4405 - 4408Q - 4409Q - 4410 - 4415 - 4418Q
- 5930 - 5935 - 5960 - 5965

Per profili tipo - For profiles type
 Domal stopper PG Finestra
 NC 45 Int. Finestra

COD.	Materiale - Material	kg		
02396 N	Nylon nero - Black nylon	0,008	20	-

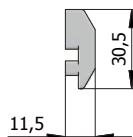
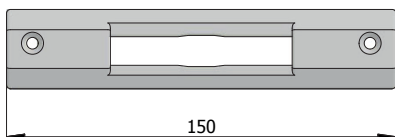

Per serrature serie - For locks series

- 1301
- 1770 - 1771 - 1777 - 1780 - 1781 - 1785
- 327 - 334 - 335 - 337 - 339 - 351 - 354 - 355 - 357 - 359
- 370 - 371 - 377 - 378 - 380 - 381 - 385 - 388
- 390 - 391 - 395 - 399
- 4335 - 4339 - 4355 - 4531
- 531 - 541
- 770 - 771 - 777 - 778 - 780 - 781 - 782 - 785 - 788
- 790 - 791 - 795 - 799
- 870 - 871 - 877 - 878 - 880 - 881 - 882 - 885 - 888
- 890 - 891 - 895 - 899
- 990 - 991 - 995 - 999

Per profili tipo - For profiles type
 R 40, R 50

COD.	Materiale - Material	kg		
02881 N	Nylon nero - Black nylon	0,024	20	-



CONTROPIASTRE IN NYLON
NYLON STRIKING PLATES

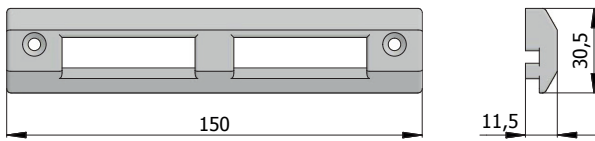

Per serrature serie - For locks series
 330 - 332 - 338 - 350 - 352 - 358
 4330 - 4338 - 4350 - 4530
 530 - 540

Per profili tipo - For profiles type
 R 40, R50

COD.	Materiale - Material			
02886 N	Nylon nero - Black nylon	0,024	20	-

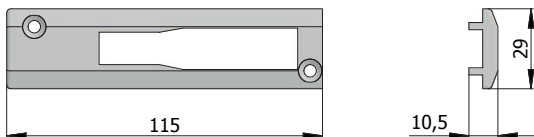

Per serrature serie - For locks series
 11141 - 11171
 1401 - 1401S - 1411 - 1411S
 1501 - 1501S
 1941 - 1971
 41141 - 41171
 4401 - 4411
 4941 - 4971
 5931 - 5941 - 5948 - 5951 - 5961 - 5971 - 5978 - 5981

Per deviatori serie - For deviators series
 0661 - 0661S - 0662

Per deviatori multipunto catenaccio basculante
 For deviators of multi-point locks with tipping dead bolt

Per profili tipo - For profiles type
 R40, R 50

COD.	Materiale - Material			
02894 N	Nylon nero - Black nylon	0,013	20	-

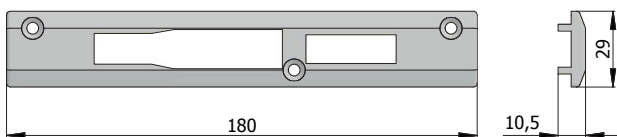

Per serrature serie - For locks series
 1300 - 1305
 1400 - 1400S - 1405 - 1405S - 1408Q - 1409Q - 1410 - 1410S -
 1415 - 1415S - 1418Q
 1500 - 1500S - 1505 - 1505S - 1508Q
 4400 - 4405 - 4408Q - 4409Q - 4410 - 4415 - 4418Q
 5930 - 5935 - 5960 - 5965

Per profili tipo - For profiles type
 R40, R 50

COD.	Materiale - Material			
02896 N	Nylon nero - Black nylon	0,019	20	-

CONTROPIASTRE IN NYLON
NYLON STRIKING PLATES

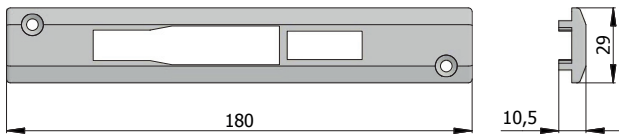

Per serrature serie - For locks series
 11140 - 11145 - 11170 - 11175
 1408 - 1409 - 1418
 1508
 1940 - 1945 - 1970 - 1975
 41140 - 41145 - 41170 - 41175
 4408 - 4409 - 4418
 4940 - 4945 - 4970 - 4975
 5938 - 5940 - 5945 - 5950 - 5968 - 5970 - 5975 - 5980

Per profili tipo - For profiles type
 R 40, R 50

COD.	Materiale - Material	kg		
02898 N	Nylon nero - Black nylon	0,021	20	-

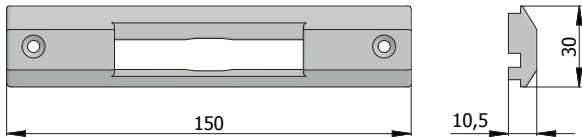

Per serrature serie - For locks series
 1301
 1770 - 1771 - 1777 - 1780 - 1781 - 1785
 327 - 334 - 335 - 337 - 339 - 351 - 354 - 355 - 357 - 359
 370 - 371 - 377 - 378 - 380 - 381 - 385 - 388
 390 - 391 - 395 - 399
 4335 - 4339 - 4355 - 4531
 531 - 541
 770 - 771 - 777 - 778 - 780 - 781 - 782 - 785 - 788
 790 - 791 - 795 - 799
 870 - 871 - 877 - 878 - 880 - 881 - 882 - 885 - 888
 890 - 891 - 895 - 899
 990 - 991 - 995 - 999

Per profili tipo - For profiles type
 Nuovo NC 40 Sormonto 1 anta

COD.	Materiale - Material	kg		
02981 N	Nylon nero - Black nylon	0,019	20	-

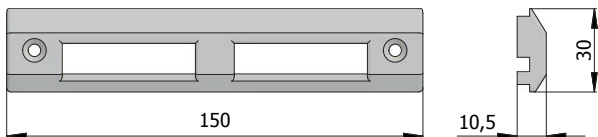

Per serrature serie - For locks series
 330 - 332 - 338 - 350 - 352 - 358
 4330 - 4338 - 4350 - 4530
 530 - 540

Per profili tipo - For profiles type
 Nuovo NC 40 Sormonto 1 anta

COD.	Materiale - Material	kg		
02986 N	Nylon nero - Black nylon	0,018	20	-



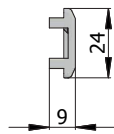
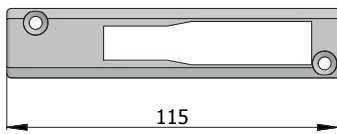

Per serrature serie - For locks series

- 11141 - 11171
- 1401 - 1401S - 1411 - 1411S
- 1501 - 1501S
- 1941 - 1971
- 41141 - 41171
- 4401 - 4411
- 4941 - 4971
- 5931 - 5941 - 5948 - 5951 - 5961 - 5971 - 5978 - 5981

Per deviatori serie - For deviators series

- 0661 - 0661S - 0662

Per deviatori multipunto catenaccio basculante

For deviators of multi-point locks with tipping dead bolt

Per profili tipo - For profiles type
 Nuovo NC 40 Sormonto 1 anta

COD.	Materiale - Material			
02994 N	Nylon nero - Black nylon	0,009	20	-

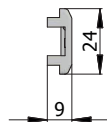
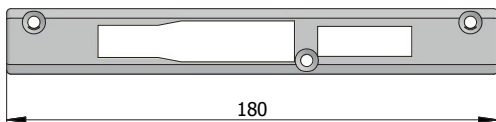

Per serrature serie - For locks series

- 1300 - 1305
- 1400 - 1400S - 1405 - 1405S - 1408Q - 1409Q - 1410 - 1410S - 1415 - 1415S - 1418Q
- 1500 - 1500S - 1505 - 1505S - 1508Q
- 4400 - 4405 - 4408Q - 4409Q - 4410 - 4415 - 4418Q
- 5930 - 5935 - 5960 - 5965

Per profili tipo - For profiles type
 Nuovo NC 40 Sormonto 1 anta

COD.	Materiale - Material			
02996 N	Nylon nero - Black nylon	0,015	20	-

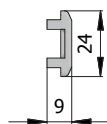
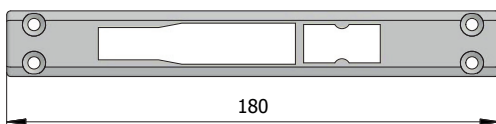

Per serrature serie - For locks series

- 11140 - 11145 - 11170 - 11175
- 1408 - 1409 - 1418
- 1508
- 1940 - 1945 - 1970 - 1975
- 41140 - 41145 - 41170 - 41175
- 4408 - 4409 - 4418
- 4940 - 4945 - 4970 - 4975
- 5938 - 5940 - 5945 - 5950 - 5968 - 5970 - 5975 - 5980

Per profili tipo - For profiles type
 Nuovo NC 40 Sormonto 1 anta

COD.	Materiale - Material			
02998 N	Nylon nero - Black nylon	0,015	20	-

CONTROPIASTRE IN NYLON
NYLON STRIKING PLATES

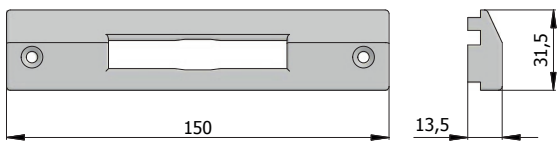

Per serrature serie - For locks series

1301
1770 - 1771 - 1777 - 1780 - 1781 - 1785
327 - 334 - 335 - 337 - 339 - 351 - 354 - 355 - 357 - 359
370 - 371 - 377 - 378 - 380 - 381 - 385 - 388
390 - 391 - 395 - 399
4335 - 4339 - 4355 - 4531
531 - 541
770 - 771 - 777 - 778 - 780 - 781 - 782 - 785 - 788
790 - 791 - 795 - 799
870 - 871 - 877 - 878 - 880 - 881 - 882 - 885 - 888
890 - 891 - 895 - 899
990 - 991 - 995 - 999

Per profili tipo - For profiles type
All.co 5 Sormonto

COD.	Materiale - Material			
03281 N	Nylon nero - Black nylon	0,031	20	-

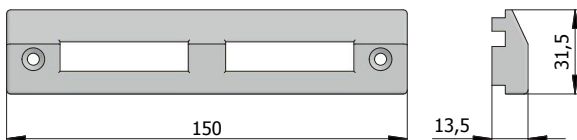

Per serrature serie - For locks series

330 - 332 - 338 - 350 - 352 - 358
4330 - 4338 - 4350 - 4530
530 - 540

Per profili tipo - For profiles type
All.co 5 Sormonto

COD.	Materiale - Material			
03286 N	Nylon nero - Black nylon	0,034	20	-

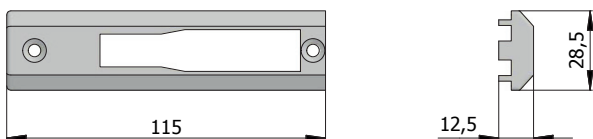

Per serrature serie - For locks series

11141 - 11171
1401 - 1401S - 1411 - 1411S
1501 - 1501S
1941 - 1971
41141 - 41171
4401 - 4411
4941 - 4971
5931 - 5941 - 5948 - 5951 - 5961 - 5971 - 5978 - 5981

Per deviatori serie - For deviators series

0661 - 0661S - 0662

Per deviatori multipunto catenaccio basculante

For deviators of multi-point locks with tipping dead bolt

Per profili tipo - For profiles type
All.co 5 Sormonto

COD.	Materiale - Material			
03294 N	Nylon nero - Black nylon	0,017	20	-



CONTROPIASTRE IN NYLON
NYLON STRIKING PLATES

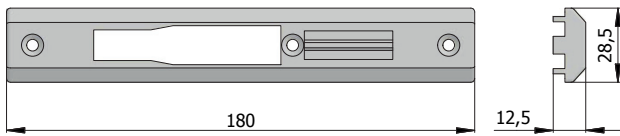

Per serrature serie - For locks series

1300 - 1305
 1400 - 1400S - 1405 - 1405S - 1408Q - 1409Q - 1410 - 1410S -
 1415 - 1415S - 1418Q
 1500 - 1500S - 1505 - 1505S - 1508Q
 4400 - 4405 - 4408Q - 4409Q - 4410 - 4415 - 4418Q
 5930 - 5935 - 5960 - 5965

Per profili tipo - For profiles type
 All.co 5 Sormonto

COD.	Materiale - Material	kg		
03296 N	Nylon nero - Black nylon	0,028	20	-

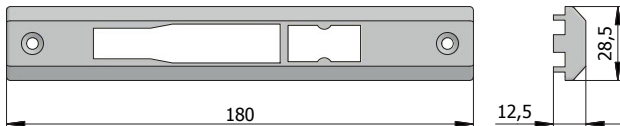

Per serrature serie - For locks series

11140 - 11145 - 11170 - 11175
 1408 - 1409 - 1418
 1508
 1940 - 1945 - 1970 - 1975
 41140 - 41145 - 41170 - 41175
 4408 - 4409 - 4418
 4940 - 4945 - 4970 - 4975
 5938 - 5940 - 5945 - 5950 - 5968 - 5970 - 5975 - 5980

Per profili tipo - For profiles type
 All.co 5 Sormonto

COD.	Materiale - Material	kg		
03298 N	Nylon nero - Black nylon	0,030	20	-

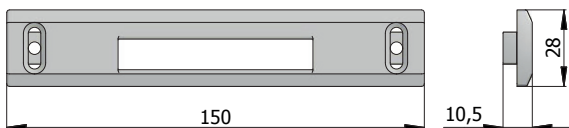

Regolazione orizzontale - Horizontal adjustment

Per serrature serie - For locks series

1301
 1770 - 1771 - 1777 - 1780 - 1781 - 1785
 327 - 334 - 335 - 337 - 339 - 351 - 354 - 355 - 357 - 359
 370 - 371 - 377 - 378 - 380 - 381 - 385 - 388
 390 - 391 - 395 - 399
 4335 - 4339 - 4355 - 4531
 531 - 541
 770 - 771 - 777 - 778 - 780 - 781 - 782 - 785 - 788
 790 - 791 - 795 - 799
 870 - 871 - 877 - 878 - 880 - 881 - 882 - 885 - 888
 890 - 891 - 895 - 899
 990 - 991 - 995 - 999

Per profili tipo - For profiles type
 R 40, R 50, Domal stopper
 PG Finestra, nuovo NC 40
 sormonto 2 ante con riporto

COD.	Materiale - Material	kg		
03781 N	Nylon nero - Black nylon	0,018	10	-

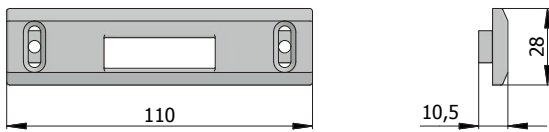

Regolazione orizzontale - Horizontal adjustment

Per serrature serie - For locks series

1301
 1771 - 1777
 327 - 337 - 351 - 357
 371 - 377 - 380 - 381 - 385 - 388 - 390 - 391 - 395 - 399
 771 - 777 - 780 - 781 - 785 - 788 - 790 - 791 - 795 - 799
 871 - 877 - 880 - 881 - 885 - 888 - 890 - 891 - 895 - 899
 990 - 991 - 995 - 999

Per profili tipo - For profiles type
 R 40, R 50, Domal stopper
 PG Finestra, nuovo NC 40
 sormonto 2 ante con riporto

COD.	Materiale - Material	kg		
03783 N	Nylon nero - Black nylon	0,022	10	-

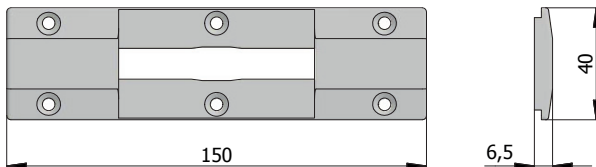

Per serrature serie - For locks series

1301
 1770 - 1771 - 1777 - 1780 - 1781 - 1785
 327 - 334 - 335 - 337 - 339 - 351 - 354 - 355 - 357 - 359
 370 - 371 - 377 - 378 - 380 - 381 - 385 - 388
 390 - 391 - 395 - 399
 4335 - 4339 - 4355 - 4531
 531 - 541
 770 - 771 - 777 - 778 - 780 - 781 - 782 - 785 - 788
 790 - 791 - 795 - 799
 870 - 871 - 877 - 878 - 880 - 881 - 882 - 885 - 888
 890 - 891 - 895 - 899
 990 - 991 - 995 - 999

Per profili tipo - For profiles type
 NC 40

COD.	Materiale - Material	kg		
04061 N	Nylon nero - Black nylon	0,021	20	-

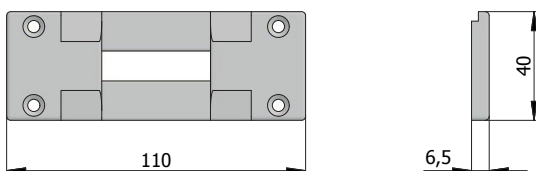

Per serrature serie - For locks series

1301
 1771 - 1777
 327 - 337 - 351 - 357
 371 - 377 - 380 - 381 - 385 - 388 - 390 - 391 - 395 - 399
 771 - 777 - 780 - 781 - 785 - 788 - 790 - 791 - 795 - 799
 871 - 877 - 880 - 881 - 885 - 888 - 890 - 891 - 895 - 899
 990 - 991 - 995 - 999

Per profili tipo - For profiles type
 NC 40

COD.	Materiale - Material	kg		
04063 N	Nylon nero - Black nylon	0,017	20	-



CONTROPIASTRE IN NYLON
NYLON STRIKING PLATES

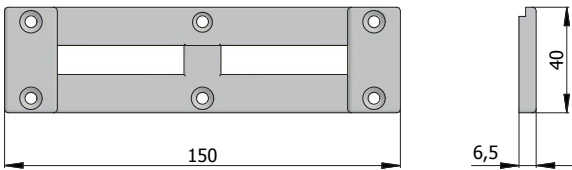

Per serrature serie - For locks series
 330 - 332 - 338 - 350 - 352 - 358
 4330 - 4338 - 4350 - 4530
 530 - 540

Per profili tipo - For profiles type
 NC 40

COD.	Materiale - Material	kg		
04066 N	Nylon nero - Black nylon	0,021	20	-

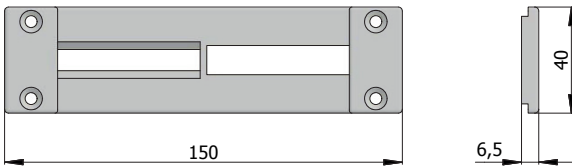

Per serrature serie - For locks series
 1775
 320 - 322 - 328 - 340 - 342 - 345 - 348
 375
 4320 - 4328 - 4340 - 4535
 535 - 545
 775
 875

Per profili tipo - For profiles type
 NC 40

COD.	Materiale - Material	kg		
04067 N	Nylon nero - Black nylon	0,021	20	-

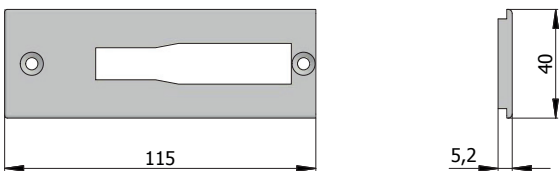

Per serrature serie - For locks series
 11141 - 11171
 1401 - 1401S - 1411 - 1411S
 1501 - 1501S
 1941 - 1971
 41141 - 41171
 4401 - 4411
 4941 - 4971
 5931 - 5941 - 5948 - 5951 - 5961 - 5971 - 5978 - 5981

Per deviatori serie - For deviators series
 0661 - 0661S - 0662

Per deviatori multipunto catenaccio basculante
 For deviators of multi-point locks with tipping dead bolt

Per profili tipo - For profiles type
 NC 40

COD.	Materiale - Material	kg		
04094 N	Nylon nero - Black nylon	0,011	20	-

CONTROPIASTRE IN NYLON
NYLON STRIKING PLATES

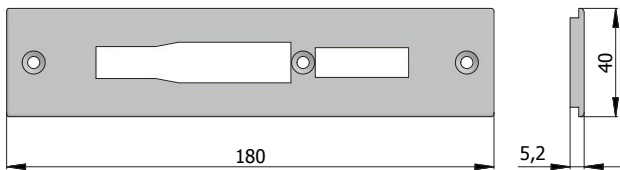

Per serrature serie - For locks series

1300 - 1305
 1400 - 1400S - 1405 - 1405S - 1408Q - 1409Q - 1410 - 1410S -
 1415 - 1415S - 1418Q
 1500 - 1500S - 1505 - 1505S - 1508Q
 4400 - 4405 - 4408Q - 4409Q - 4410 - 4415 - 4418Q
 5930 - 5935 - 5960 - 5965

Per profili tipo - For profiles type
 NC 40

COD.	Materiale - Material	kg		
04096 N	Nylon nero - Black nylon	0,016	20	-

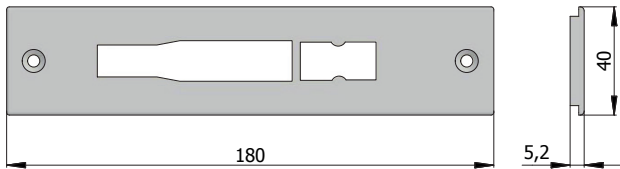

Per serrature serie - For locks series

11140 - 11145 - 11170 - 11175
 1408 - 1409 - 1418
 1508
 1940 - 1945 - 1970 - 1975
 41140 - 41145 - 41170 - 41175
 4408 - 4409 - 4418
 4940 - 4945 - 4970 - 4975
 5938 - 5940 - 5945 - 5950 - 5968 - 5970 - 5975 - 5980

Per profili tipo - For profiles type
 NC 40

COD.	Materiale - Material	kg		
04098 N	Nylon nero - Black nylon	0,020	20	-

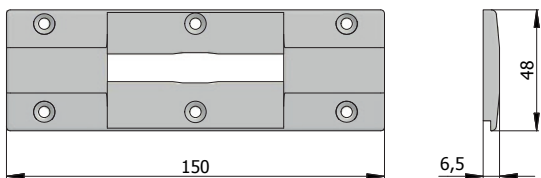

Per serrature serie - For locks series

1301
 1770 - 1771 - 1777 - 1780 - 1781 - 1785
 327 - 334 - 335 - 337 - 339 - 351 - 354 - 355 - 357 - 359
 370 - 371 - 377 - 378 - 380 - 381 - 385 - 388
 390 - 391 - 395 - 399
 4335 - 4339 - 4355 - 4531
 531 - 541
 770 - 771 - 777 - 778 - 780 - 781 - 782 - 785 - 788
 790 - 791 - 795 - 799
 870 - 871 - 877 - 878 - 880 - 881 - 882 - 885 - 888
 890 - 891 - 895 - 899
 990 - 991 - 995 - 999

Per profili tipo - For profiles type
 NC 50 B

COD.	Materiale - Material	kg		
05061 N	Nylon nero - Black nylon	0,023	20	-

CONTROPIASTRE IN NYLON
NYLON STRIKING PLATES

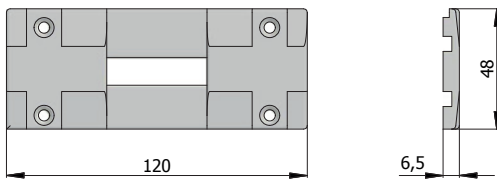

Per serrature serie - For locks series

1301
1771 - 1777
327 - 337 - 351 - 357
371 - 377 - 380 - 381 - 385 - 388 - 390 - 391 - 395 - 399
771 - 777 - 780 - 781 - 785 - 788 - 790 - 791 - 795 - 799
871 - 877 - 880 - 881 - 885 - 888 - 890 - 891 - 895 - 899
990 - 991 - 995 - 999

Per profili tipo - For profiles type
NC 50 B

COD.	Materiale - Material	kg		
05063 N	Nylon nero - Black nylon	0,030	20	-

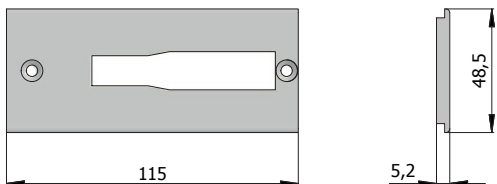

Per serrature serie - For locks series

11141 - 11171
1401 - 1401S - 1411 - 1411S
1501 - 1501S
1941 - 1971
41141 - 41171
4401 - 4411
4941 - 4971
5931 - 5941 - 5948 - 5951 - 5961 - 5971 - 5978 - 5981

Per deviatori serie - For deviators series

0661 - 0661S - 0662

Per deviatori multipunto catenaccio basculante

For deviators of multi-point locks with tipping dead bolt

Per profili tipo - For profiles type
NC 50 B

COD.	Materiale - Material	kg		
05094 N	Nylon nero - Black nylon	0,014	20	-

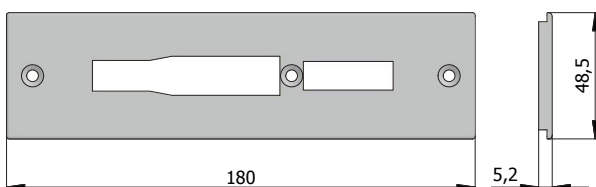

Per serrature serie - For locks series

1300 - 1305
1400 - 1400S - 1405 - 1405S - 1408Q - 1409Q - 1410 - 1410S -
1415 - 1415S - 1418Q
1500 - 1500S - 1505 - 1505S - 1508Q
4400 - 4405 - 4408Q - 4409Q - 4410 - 4415 - 4418Q
5930 - 5935 - 5960 - 5965

Per profili tipo - For profiles type
NC 50 B

COD.	Materiale - Material	kg		
05096 N	Nylon nero - Black nylon	0,022	20	-



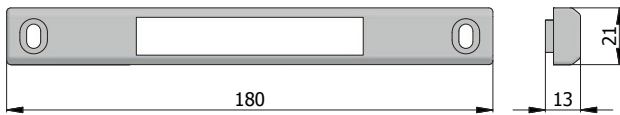

Per serrature serie - For locks series
11140 - 11141 - 11145 - 11170 - 11171 - 11175
1940 - 1941 - 1945 - 1970 - 1971 - 1975
41140 - 41141 - 41145 - 41170 - 41171 - 41175
4940 - 4941 - 4945 - 4970 - 4971 - 4975
5930 - 5931 - 5935 - 5938 - 5940 - 5941 - 5945 - 5948
5950 - 5951 - 5960 - 5961 - 5965 - 5968
5970 - 5971 - 5975 - 5978 - 5980 - 5981

Per profili tipo - For profiles type
All.co 5

COD.	Materiale - Material	kg		
02121 L	Lega speciale verniciata Painted special alloy	0,151	20	-

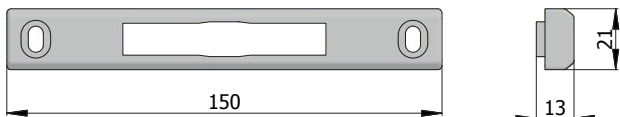

Per serrature serie - For locks series
1301
1770 - 1771 - 1777 - 1780 - 1781 - 1785
327 - 334 - 335 - 337 - 339 - 351 - 354 - 355 - 357 - 359
370 - 371 - 377 - 378 - 380 - 381 - 385 - 388
390 - 391 - 395 - 399
4335 - 4339 - 4355 - 4531
531 - 541
770 - 771 - 777 - 778 - 780 - 781 - 782 - 785 - 788
790 - 791 - 795 - 799
870 - 871 - 877 - 878 - 880 - 881 - 882 - 885 - 888
890 - 891 - 895 - 899
990 - 991 - 995 - 999

Per profili tipo - For profiles type
All.co 5

COD.	Materiale - Material	kg		
02181 L	Lega speciale verniciata Painted special alloy	0,136	20	-



Per serrature serie - For locks series
1401 - 1401S - 1411 - 1411S
1501 - 1501S
4401 - 4411

Per deviatori serie - For deviators series
0661 - 0661S - 0662

Per deviatori multipunto catenaccio basculante
For deviators of multi-point locks with tipping dead bolt

Per profili tipo - For profiles type
All.co 5

COD.	Materiale - Material	kg		
02194 L	Lega speciale verniciata Painted special alloy	0,053	20	-

CONTROPIASTRE IN METALLO
METAL STRIKING PLATES

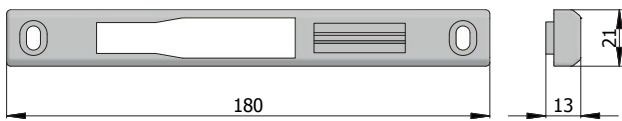

Per serrature serie - For locks series

1300 - 1305
1400 - 1400S - 1405 - 1405S - 1408Q - 1409Q - 1410 - 1410S
1415 - 1415S - 1418Q
1500 - 1500S - 1505 - 1505S - 1508Q
4400 - 4405 - 4408Q - 4409Q - 4410 - 4415 - 4418Q

Per profili tipo - For profiles type
All.co 5

COD.	Materiale - Material	kg		
02196 L	Lega speciale verniciata Painted special alloy	0,143	20	-

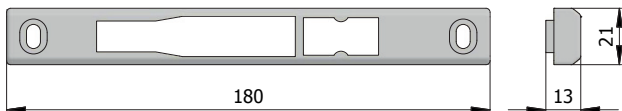

Per serrature serie - For locks series

1408 - 1409 - 1418
1508
4408 - 4409 - 4418

Per profili tipo - For profiles type
All.co 5

COD.	Materiale - Material	kg		
02198 L	Lega speciale verniciata Painted special alloy	0,063	20	-

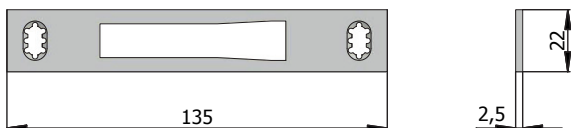

Per serrature serie - For locks series

11141 - 11171
1401 - 1401S - 1411 - 1411S
1501 - 1501S
1941 - 1971
41141 - 41171
4401 - 4411
4941 - 4971
5931 - 5941 - 5948 - 5951 - 5961 - 5971 - 5978 - 5981

Per deviatori serie - For deviators series

0661 - 0661S - 0662

Per deviatori multipunto catenaccio basculante

For deviators of multi-point locks with tipping dead bolt

Per profili tipo - For profiles type
Domal stopper PG Finestra
NC 45 Int. Finestra

COD.	Materiale - Material	kg		
02224 X	Acciaio inox - Stainless steel	0,052	10	-



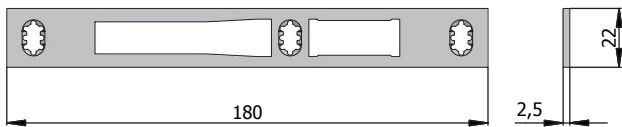

Per serrature serie - For locks series

1300 - 1305
1400 - 1400S - 1405 - 1405S - 1408Q - 1409Q - 1410 - 1410S -
1415 - 1415S - 1418Q
1500 - 1500S - 1505 - 1505S - 1508Q
4400 - 4405 - 4408Q - 4409Q - 4410 - 4415 - 4418Q
5930 - 5935 - 5960 - 5965

Per profili tipo - For profiles type
Domal stopper PG Finestra
NC 45 Int. Finestra

COD.	Materiale - Material	kg		
02226 X	Acciaio inox - Stainless steel	0,068	10	-

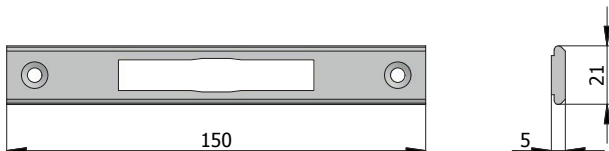

Per serrature serie - For locks series

1301
1770 - 1771 - 1777 - 1780 - 1781 - 1785
327 - 334 - 335 - 337 - 339 - 351 - 354 - 355 - 357 - 359
370 - 371 - 377 - 378 - 380 - 381 - 385 - 388
390 - 391 - 395 - 399
4335 - 4339 - 4355 - 4531
531 - 541
770 - 771 - 777 - 778 - 780 - 781 - 782 - 785 - 788
790 - 791 - 795 - 799
870 - 871 - 877 - 878 - 880 - 881 - 882 - 885 - 888
890 - 891 - 895 - 899
990 - 991 - 995 - 999

Per profili tipo - For profiles type
Domal stopper PG Finestra
NC 45 Int. Finestra

COD.	Materiale - Material	kg		
02381 L	Alluminio - Aluminium	0,076	20	-

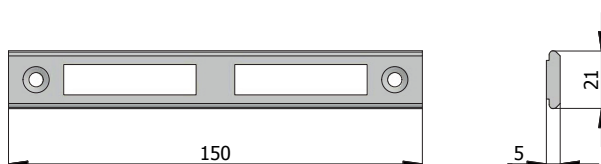

Per serrature serie - For locks series

330 - 332 - 338 - 350 - 352 - 358
4330 - 4338 - 4350 - 4530
530 - 540

Per profili tipo - For profiles type
Domal stopper PG Finestra
NC 45 Int. Finestra

COD.	Materiale - Material	kg		
02386 L	Alluminio - Aluminium	0,035	20	-

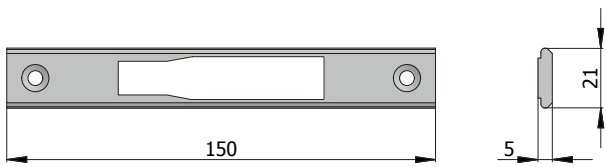

Per serrature serie - For locks series
11141 - 11171
1401 - 1401S - 1411 - 1411S
1501 - 1501S
1941 - 1971
41141 - 41171
4401 - 4411
4941 - 4971
5931 - 5941 - 5948 - 5951 - 5961 - 5971 - 5978 - 5981

Per deviatori serie - For deviators series
0661 - 0661S - 0662

Per deviatori multipunto catenaccio basculante
For deviators of multi-point locks with tipping dead bolt

Per profili tipo - For profiles type
Domal stopper PG Finestra
NC 45 Int. Finestra

COD.	Materiale - Material	kg		
02394 L	Alluminio - Aluminium	0,035	20	-

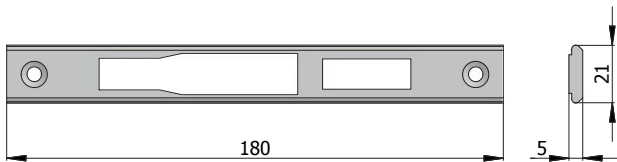

Per serrature serie - For locks series
1300 - 1305
1400 - 1400S - 1405 - 1405S - 1408Q - 1409Q - 1410 - 1410S -
1415 - 1415S - 1418Q
1500 - 1500S - 1505 - 1505S - 1508Q
4400 - 4405 - 4408Q - 4409Q - 4410 - 4415 - 4418Q
5930 - 5935 - 5960 - 5965

Per profili tipo - For profiles type
Domal stopper PG Finestra
NC 45 Int. Finestra

COD.	Materiale - Material	kg		
02396 L	Alluminio - Aluminium	0,038	20	-

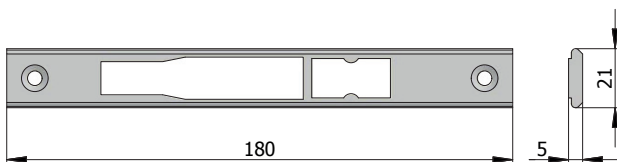

Per serrature serie - For locks series
11140 - 11145 - 11170 - 11175
1408 - 1409 - 1418
1508
1940 - 1945 - 1970 - 1975
41140 - 41145 - 41170 - 41175
4408 - 4409 - 4418
4940 - 4945 - 4970 - 4975
5938 - 5940 - 5945 - 5950 - 5968 - 5970 - 5975 - 5980

Per profili tipo - For profiles type
Domal stopper PG Finestra
NC 45 Int. Finestra

COD.	Materiale - Material	kg		
02398 L	Alluminio - Aluminium	0,038	20	-



CONTROPIASTRE IN METALLO
METAL STRIKING PLATES

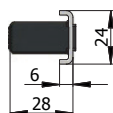

Per serrature serie - For locks series
1401S - 1411S
1501S
1601S - 1611S - 1621S - 1631S
1701S - 1721S - 1741S - 1761S

Per deviatori serie - For deviators series
0661S - 0761S

Per deviatori serrature multipunto ad ingranaggi
(tranne serie 1740S - 1760S)
For deviators of vertical multi-point locks with gear mechanism
movements (but series 1740S - 1760S)

COD.	Materiale - Material	kg		
02444 XU	Acciaio inox - Stainless steel	0,077	10	-

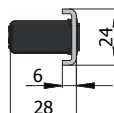

Per serrature serie - For locks series
1400S - 1405S - 1410S - 1415S
1500S - 1505S
1600S - 1605S - 1610S - 1615S
1620S - 1625S - 1630S - 1635S
1700S - 1705S - 1720S - 1725S
1740S - 1745S - 1760S - 1765S

COD.	Materiale - Material	kg		
02446 XU	Acciaio inox - Stainless steel	0,089	10	-

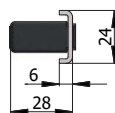
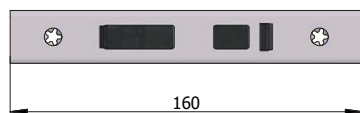

Per deviatori serie - For deviators series
0766S

NEW

Per deviatori multipunto serie - For multi-point deviators series
1740S - 1741S - 1745S - 1760S - 1761S - 1765S

COD.	Materiale - Material	kg		
02449 XU	Acciaio inox - Stainless steel	0,056	10	-

CONTROPIASTRE IN METALLO
METAL STRIKING PLATES

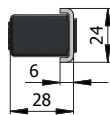
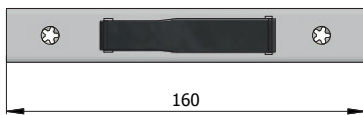

Per serrature serie - For locks series

- 1401 - 1411
- 1491
- 1501 - 1531 - 1541
- 4401 - 4411
- 4491

Per deviatori serie - For deviators series

- 0661 - 0661S - 0662

Per deviatori multipunto catenaccio basculante

For deviators of multi-point locks with tipping dead bolt

COD.	Materiale - Material			
02494 XU	Acciaio inox - Stainless steel	0,072	10	-

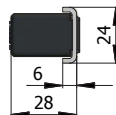
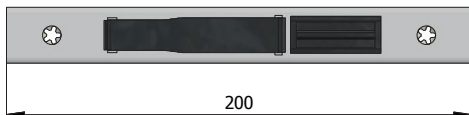

Per serrature serie - For locks series

- 1400 - 1405 - 1410 - 1415
- 1490 - 1495
- 1500 - 1505
- 4400 - 4405 - 4410 - 4415
- 4490 - 4495

COD.	Materiale - Material			
02496 XU	Acciaio inox - Stainless steel	0,084	10	-

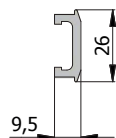
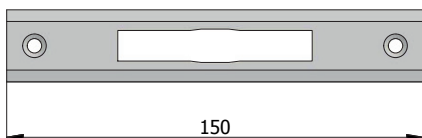

Per serrature serie - For locks series

- 1301
- 1770 - 1771 - 1777 - 1780 - 1781 - 1785
- 327 - 334 - 335 - 337 - 339 - 351 - 354 - 355 - 357 - 359
- 370 - 371 - 377 - 378 - 380 - 381 - 385 - 388
- 390 - 391 - 395 - 399
- 4335 - 4339 - 4355 - 4531
- 531 - 541
- 770 - 771 - 777 - 778 - 780 - 781 - 782 - 785 - 788
- 790 - 791 - 795 - 799
- 870 - 871 - 877 - 878 - 880 - 881 - 882 - 885 - 888
- 890 - 891 - 895 - 899
- 990 - 991 - 995 - 999

Per profili tipo - For profiles type
Domal Break PA 52 Porta
NC 55 Int. Porta

COD.	Materiale - Material			
02681 L	Alluminio - Aluminium	0,056	10	-



CONTROPIASTRE IN METALLO
METAL STRIKING PLATES

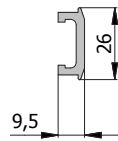
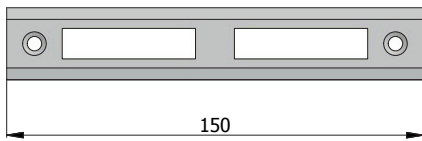

Per serrature serie - For locks series
 330 - 332 - 338 - 350 - 352 - 358
 4330 - 4338 - 4350 - 4530
 530 - 540

Per profili tipo - For profiles type
 Domal Break PA 52 Porta
 NC 55 Int. Porta

COD.	Materiale - Material	kg		
02686 L	Alluminio - Aluminium	0,053	10	-

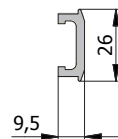
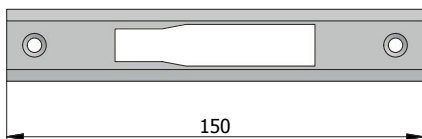

Per serrature serie - For locks series
 11141 - 11171
 1401 - 1401S - 1411 - 1411S
 1501 - 1501S
 1941 - 1971
 41141 - 41171
 4401 - 4411
 4941 - 4971
 5931 - 5941 - 5948 - 5951 - 5961 - 5971 - 5978 - 5981

Per deviatori serie - For deviators series
 0661 - 0661S - 0662

Per deviatori multipunto catenaccio basculante
 For deviators of multi-point locks with tipping dead bolt

Per profili tipo - For profiles type
 Domal Break PA 52 Porta
 NC 55 Int. Porta

COD.	Materiale - Material	kg		
02694 L	Alluminio - Aluminium	0,053	10	-

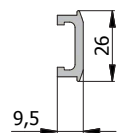
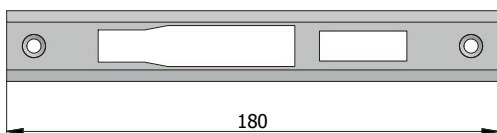

Per serrature serie - For locks series
 1300 - 1305
 1400 - 1400S - 1405 - 1405S - 1408Q - 1409Q - 1410 - 1410S -
 1415 - 1415S - 1418Q
 1500 - 1500S - 1505 - 1505S - 1508Q
 4400 - 4405 - 4408Q - 4409Q - 4410 - 4415 - 4418Q
 5930 - 5935 - 5960 - 5965

Per profili tipo - For profiles type
 Domal Break PA 52 Porta
 NC 55 Int. Porta

COD.	Materiale - Material	kg		
02696 L	Alluminio - Aluminium	0,060	10	-

CONTROPIASTRE IN METALLO
METAL STRIKING PLATES

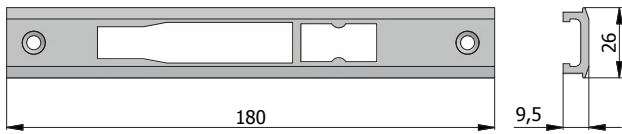

Per serrature serie - For locks series
 11140 - 11145 - 11170 - 11175
 1408 - 1409 - 1418
 1508
 1940 - 1945 - 1970 - 1975
 41140 - 41145 - 41170 - 41175
 4408 - 4409 - 4418
 4940 - 4945 - 4970 - 4975
 5938 - 5940 - 5945 - 5950 - 5968 - 5970 - 5975 - 5980

Per profili tipo - For profiles type
 Domal Break PA 52 Porta
 NC 55 Int. Porta

COD.	Materiale - Material			
02698 L	Alluminio - Aluminium	0,059	10	-

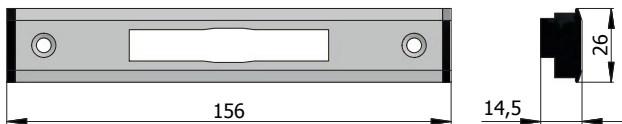

Per serrature serie - For locks series
 1301
 1770 - 1771 - 1777 - 1780 - 1781 - 1785
 327 - 334 - 335 - 337 - 339 - 351 - 354 - 355 - 357 - 359
 370 - 371 - 377 - 378 - 380 - 381 - 385 - 388
 390 - 391 - 395 - 399
 4335 - 4339 - 4355 - 4531
 531 - 541
 770 - 771 - 777 - 778 - 780 - 781 - 782 - 785 - 788
 790 - 791 - 795 - 799
 870 - 871 - 877 - 878 - 880 - 881 - 882 - 885 - 888
 890 - 891 - 895 - 899
 990 - 991 - 995 - 999

Per profili tipo - For profiles type
 EKIP 40, 50 Complanare

COD.	Materiale - Material			
02781 L	Alluminio - Aluminium	0,065	10	-

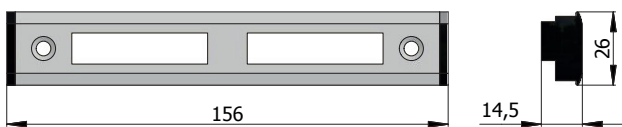

Per serrature serie - For locks series
 330 - 332 - 338 - 350 - 352 - 358
 4330 - 4338 - 4350 - 4530
 530 - 540

Per profili tipo - For profiles type
 EKIP 40, 50 Complanare

COD.	Materiale - Material			
02786 L	Alluminio - Aluminium	0,071	10	-



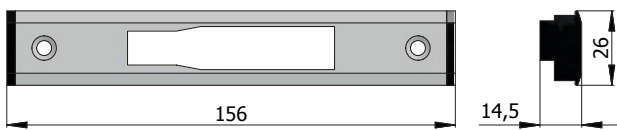

Per serrature serie - For locks series

11141 - 11171
1401 - 1401S - 1411 - 1411S
1501 - 1501S
1941 - 1971
41141 - 41171
4401 - 4411
4941 - 4971
5931 - 5941 - 5948 - 5951 - 5961 - 5971 - 5978 - 5981

Per deviatori serie - For deviators series

0661 - 0661S - 0662

Per deviatori multipunto catenaccio basculante

For deviators of multi-point locks with tipping dead bolt

Per profili tipo - For profiles type
EKIP 40, 50 Complanare

COD.	Materiale - Material			
02794 L	Alluminio - Aluminium	0,071	10	-

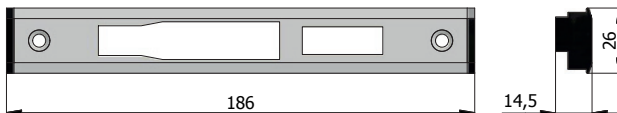

Per serrature serie - For locks series

1300 - 1305
1400 - 1400S - 1405 - 1405S - 1408Q - 1409Q - 1410 - 1410S -
1415 - 1415S - 1418Q
1500 - 1500S - 1505 - 1505S - 1508Q
4400 - 4405 - 4408Q - 4409Q - 4410 - 4415 - 4418Q
5930 - 5935 - 5960 - 5965

Per profili tipo - For profiles type
EKIP 40, 50 Complanare

COD.	Materiale - Material			
02796 L	Alluminio - Aluminium	0,070	10	-

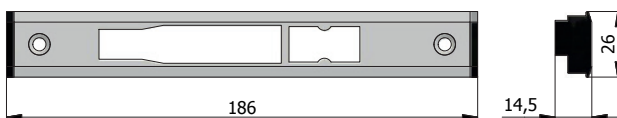

Per serrature serie - For locks series

11140 - 11145 - 11170 - 11175
1408 - 1409 - 1418
1508
1940 - 1945 - 1970 - 1975
41140 - 41145 - 41170 - 41175
4408 - 4409 - 4418
4940 - 4945 - 4970 - 4975
5938 - 5940 - 5945 - 5950 - 5968 - 5970 - 5975 - 5980

Per profili tipo - For profiles type
EKIP 40, 50 Complanare

COD.	Materiale - Material			
02798 L	Alluminio - Aluminium	0,080	10	-

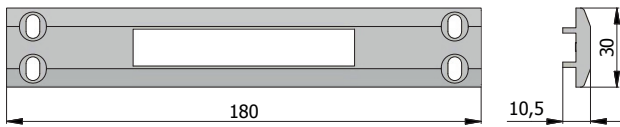

Per serrature serie - For locks series
11140 - 11141 - 11145 - 11170 - 11171 - 11175
1940 - 1941 - 1945 - 1970 - 1971 - 1975
41140 - 41141 - 41145 - 41170 - 41171 - 41175
4940 - 4941 - 4945 - 4970 - 4971 - 4975
5930 - 5931 - 5935 - 5938 - 5940 - 5941 - 5945 - 5948
5950 - 5951 - 5960 - 5961 - 5965 - 5968
5970 - 5971 - 5975 - 5978 - 5980 - 5981

Per profili tipo - For profiles type
R 40, R 50

COD.	Materiale - Material	kg		
02821 L	Lega speciale verniciata Painted special alloy	0,133	20	-

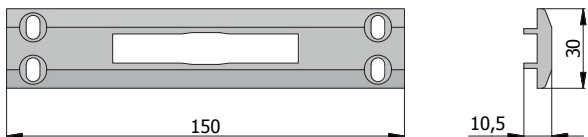

Per serrature serie - For locks series
1301
1770 - 1771 - 1777 - 1780 - 1781 - 1785
327 - 334 - 335 - 337 - 339 - 351 - 354 - 355 - 357 - 359
370 - 371 - 377 - 378 - 380 - 381 - 385 - 388
390 - 391 - 395 - 399
4335 - 4339 - 4355 - 4531
531 - 541
770 - 771 - 777 - 778 - 780 - 781 - 782 - 785 - 788
790 - 791 - 795 - 799
870 - 871 - 877 - 878 - 880 - 881 - 882 - 885 - 888
890 - 891 - 895 - 899
990 - 991 - 995 - 999

Per profili tipo - For profiles type
R 40, R 50

COD.	Materiale - Material	kg		
02881 L	Lega speciale verniciata Painted special alloy	0,118	20	-

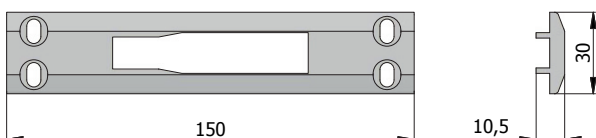

Per serrature serie - For locks series
1401 - 1401S - 1411 - 1411S
1501 - 1501S
4401 - 4411

Per deviatori serie - For deviators series
0661 - 0661S - 0662

Per deviatori multipunto catenaccio basculante
For deviators of multi-point locks with tipping dead bolt

Per profili tipo - For profiles type
R 40, R 50

COD.	Materiale - Material	kg		
02894 L	Lega speciale verniciata Painted special alloy	0,112	20	-

CONTROPIASTRE IN METALLO
METAL STRIKING PLATES

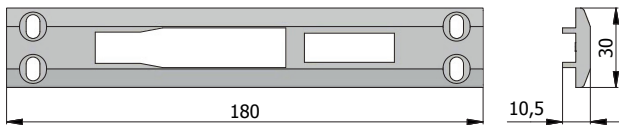

Per serrature serie - For locks series

1300 - 1305
1400 - 1400S - 1405 - 1405S - 1408Q - 1409Q - 1410 - 1410S
1415 - 1415S - 1418Q
1500 - 1500S - 1505 - 1505S - 1508Q
4400 - 4405 - 4408Q - 4409Q - 4410 - 4415 - 4418Q

Per profili tipo - For profiles type
R 40, R 50

COD.	Materiale - Material	kg		
02896 L	Lega speciale verniciata Painted special alloy	0,119	20	-

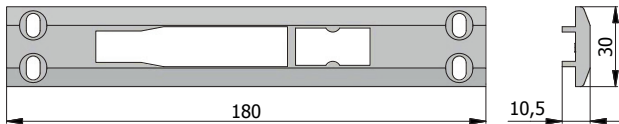

Per serrature serie - For locks series

1408 - 1409 - 1418
1508
4408 - 4409 - 4418

Per profili tipo - For profiles type
R 40, R 50

COD.	Materiale - Material	kg		
02898 L	Lega speciale verniciata Painted special alloy	0,127	20	-

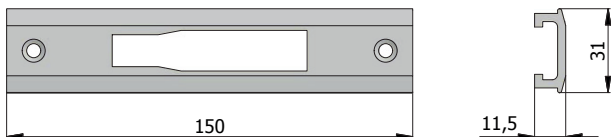

Per serrature serie - For locks series

11141 - 11171
1401 - 1401S - 1411 - 1411S
1501 - 1501S
1941 - 1971
41141 - 41171
4401 - 4411
4941 - 4971
5931 - 5941 - 5948 - 5951 - 5961 - 5971 - 5978 - 5981

Per deviatori serie - For deviators series

0661 - 0661S - 0662

Per deviatori multipunto catenaccio basculante

For deviators of multi-point locks with tipping dead bolt

Per profili tipo - For profiles type
Domal stopper PG Porta
NC 45 Int. Porta

COD.	Materiale - Material	kg		
03194 L	Alluminio - Aluminium	0,075	10	-

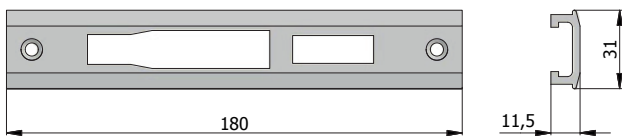

Per serrature serie - For locks series

1300 - 1305
1400 - 1400S - 1405 - 1405S - 1408Q - 1409Q - 1410 - 1410S -
1415 - 1415S - 1418Q
1500 - 1500S - 1505 - 1505S - 1508Q
4400 - 4405 - 4408Q - 4409Q - 4410 - 4415 - 4418Q
5930 - 5935 - 5960 - 5965

Per profili tipo - For profiles type
Domal stopper PG Porta
NC 45 Int. Porta

COD.	Materiale - Material	kg		
03196 L	Alluminio - Aluminium	0,093	10	-

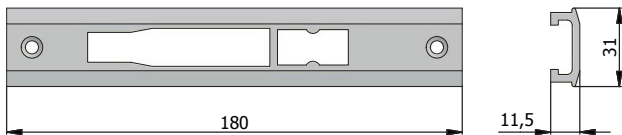

Per serrature serie - For locks series

11140 - 11145 - 11170 - 11175
1408 - 1409 - 1418
1508
1940 - 1945 - 1970 - 1975
41140 - 41145 - 41170 - 41175
4408 - 4409 - 4418
4940 - 4945 - 4970 - 4975
5938 - 5940 - 5945 - 5950 - 5968 - 5970 - 5975 - 5980

Per profili tipo - For profiles type
Domal stopper PG Porta
NC 45 Int. Porta

COD.	Materiale - Material	kg		
03198 L	Alluminio - Aluminium	0,085	10	-

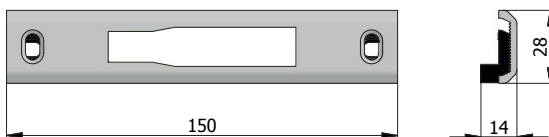

Per serrature serie - For locks series

11141 - 11171
1401 - 1401S - 1411 - 1411S
1501 - 1501S
1941 - 1971
41141 - 41171
4401 - 4411
4941 - 4971
5931 - 5941 - 5948 - 5951 - 5961 - 5971 - 5978 - 5981

Per deviatori serie - For deviators series

0661 - 0661S - 0662

Per deviatori multipunto catenaccio basculante

For deviators of multi-point locks with tipping dead bolt

Per profili tipo - For profiles type
ALLIANCE Sistema A

COD.	Materiale - Material	kg		
03394 L	Alluminio - Aluminium	0,076	10	-

CONTROPIASTRE IN METALLO
METAL STRIKING PLATES

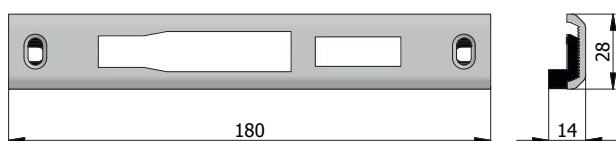

Per serrature serie - For locks series

1300 - 1305
 1400 - 1400S - 1405 - 1405S - 1408Q - 1409Q - 1410 - 1410S -
 1415 - 1415S - 1418Q
 1500 - 1500S - 1505 - 1505S - 1508Q
 4400 - 4405 - 4408Q - 4409Q - 4410 - 4415 - 4418Q
 5930 - 5935 - 5960 - 5965

Per profili tipo - For profiles type
 ALLIANCE Sistema A

COD.	Materiale - Material			
03396 L	Alluminio - Aluminium	0,085	10	-

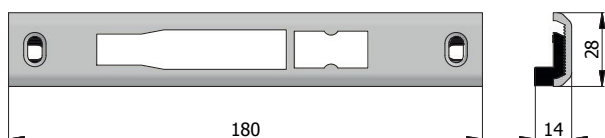

Per serrature serie - For locks series

11140 - 11145 - 11170 - 11175
 1408 - 1409 - 1418
 1508
 1940 - 1945 - 1970 - 1975
 41140 - 41145 - 41170 - 41175
 4408 - 4409 - 4418
 4940 - 4945 - 4970 - 4975
 5938 - 5940 - 5945 - 5950 - 5968 - 5970 - 5975 - 5980

Per profili tipo - For profiles type
 ALLIANCE Sistema A

COD.	Materiale - Material			
03398 L	Alluminio - Aluminium	0,082	10	-



Per serrature serie - For locks series

1301
 1770 - 1771 - 1777 - 1780 - 1781 - 1785
 327 - 334 - 335 - 337 - 339 - 351 - 354 - 355 - 357 - 359
 370 - 371 - 377 - 378 - 380 - 381 - 385 - 388
 390 - 391 - 395 - 399
 4335 - 4339 - 4355 - 4531
 531 - 541
 770 - 771 - 777 - 778 - 780 - 781 - 782 - 785 - 788
 790 - 791 - 795 - 799
 870 - 871 - 877 - 878 - 880 - 881 - 882 - 885 - 888
 890 - 891 - 895 - 899
 990 - 991 - 995 - 999

Per profili tipo - For profiles type
 NC 40

COD.	Materiale - Material			
04061 A	Acciaio plastificato Plastic plated steel	0,060	50	-

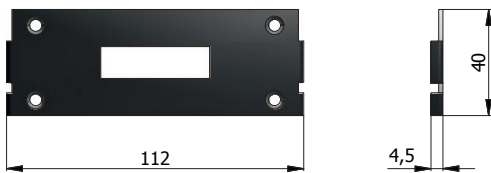

Per serrature serie - For locks series

1301
1771 - 1777
327 - 337 - 351 - 357
371 - 377 - 380 - 381 - 385 - 388 - 390 - 391 - 395 - 399
771 - 777 - 780 - 781 - 785 - 788 - 790 - 791 - 795 - 799
871 - 877 - 880 - 881 - 885 - 888 - 890 - 891 - 895 - 899
990 - 991 - 995 - 999

Per profili tipo - For profiles type
NC 40

COD.	Materiale - Material			
04063 A	Acciaio plastificato Plastic plated steel	0,046	50	-

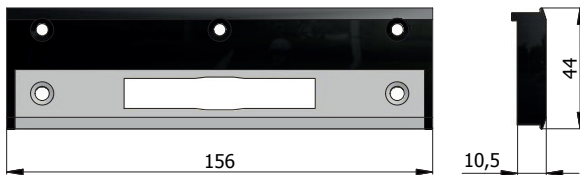

Per serrature serie - For locks series

1301
1770 - 1771 - 1777 - 1780 - 1781 - 1785
327 - 334 - 335 - 337 - 339 - 351 - 354 - 355 - 357 - 359
370 - 371 - 377 - 378 - 380 - 381 - 385 - 388
390 - 391 - 395 - 399
4335 - 4339 - 4355 - 4531
531 - 541
770 - 771 - 777 - 778 - 780 - 781 - 782 - 785 - 788
790 - 791 - 795 - 799
870 - 871 - 877 - 878 - 880 - 881 - 882 - 885 - 888
890 - 891 - 895 - 899
990 - 991 - 995 - 999

Per profili tipo - For profiles type
Export 50 T.T.
Porta apertura esterna

Ad esaurimento - sostituito da 02681 X + 0743 N
End of line - replaced by 02681 X + 0743 N

COD.	Materiale - Material			
04481 L	Alluminio - Aluminium	0,074	10	-

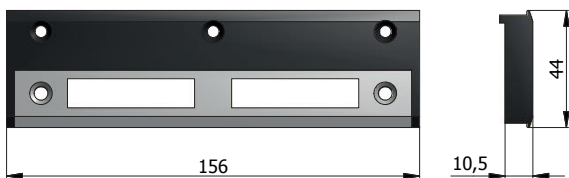

Per serrature serie - For locks series

330 - 332 - 338 - 350 - 352 - 358
4330 - 4338 - 4350 - 4530
530 - 540

Per profili tipo - For profiles type
Export 50 T.T.
Porta apertura esterna

Ad esaurimento - sostituito da 02646 X + 0742 N
End of line - replaced by 02646 X + 0742 N

COD.	Materiale - Material			
04486 L	Alluminio - Aluminium	0,071	10	-



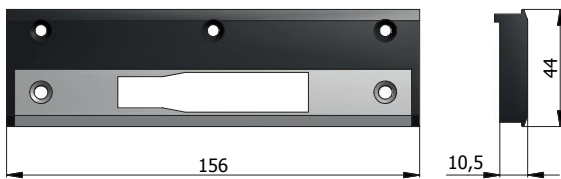

Per serrature serie - For locks series
11141 - 11171
1401 - 1401S - 1411 - 1411S
1501 - 1501S
1941 - 1971
41141 - 41171
4401 - 4411
4941 - 4971
5931 - 5941 - 5948 - 5951 - 5961 - 5971 - 5978 - 5981

Per deviatori serie - For deviators series
0661 - 0661S - 0662

Per deviatori multipunto catenaccio basculante
For deviators of multi-point locks with tipping dead bolt

Ad esaurimento - sostituito da 02694 X + 0743 N
End of line - replaced by 02694 X + 0743 N

Per profili tipo - For profiles type
Export 50 T.T.
Porta apertura esterna

COD.	Materiale - Material	kg		
04494 L	Alluminio - Aluminium	0,071	10	-

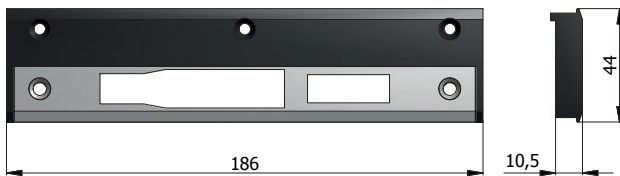

Per serrature serie - For locks series
1300 - 1305
1400 - 1400S - 1405 - 1405S - 1408Q - 1409Q - 1410 - 1410S -
1415 - 1415S - 1418Q
1500 - 1500S - 1505 - 1505S - 1508Q
4400 - 4405 - 4408Q - 4409Q - 4410 - 4415 - 4418Q
5930 - 5935 - 5960 - 5965

Ad esaurimento - sostituito da 02696 X + 0742 N
End of line - replaced by 02696 X + 0742 N

Per profili tipo - For profiles type
Export 50 T.T.
Porta apertura esterna

COD.	Materiale - Material	kg		
04496 L	Alluminio - Aluminium	0,079	10	-

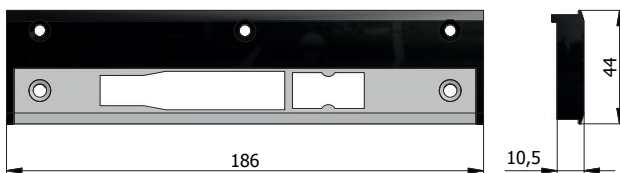

Per serrature serie - For locks series
11140 - 11145 - 11170 - 11175
1408 - 1409 - 1418
1508
1940 - 1945 - 1970 - 1975
41140 - 41145 - 41170 - 41175
4408 - 4409 - 4418
4940 - 4945 - 4970 - 4975
5938 - 5940 - 5945 - 5950 - 5968 - 5970 - 5975 - 5980

Ad esaurimento - sostituito da 02696 X + 0742 N
End of line - replaced by 02696 X + 0742 N

Per profili tipo - For profiles type
Export 50 T.T.
Porta apertura esterna

COD.	Materiale - Material	kg		
04498 L	Alluminio - Aluminium	0,079	10	-



SERIE 023 X

PER PROFILI TIPO
FOR PROFILES TYPE

CAMERA EUROPEA SERIE FINESTRA
DOMAL STOPPER PG FINESTRA
NC 45 INT. FINESTRA
EXPORT 45 FINESTRA
NUOVO NC 40 SORMONTO 1 ANTA

VITI E CAMME INOX
STAINLESS STEEL
SCREWS AND CAMS

VASCHETTA GUIDA
SCROCCO E RULLO
LATCH BOLT AND
ROLLER BOLT GUIDE

INSERTO PER ELETTRORISERRE
ELECTRIC LOCKS DEVICE

PIASTRA INOX SATINATA
BRUSH-POLISHED STAINLESS
STEEL PLATE

VASCHETTA COPRI-SPACCO
HOUSING COVER

REGOLAZIONE VERTICALE
VERTICAL ADJUSTMENT

REGOLAZIONE ORIZZONTALE
HORIZONTAL ADJUSTMENT

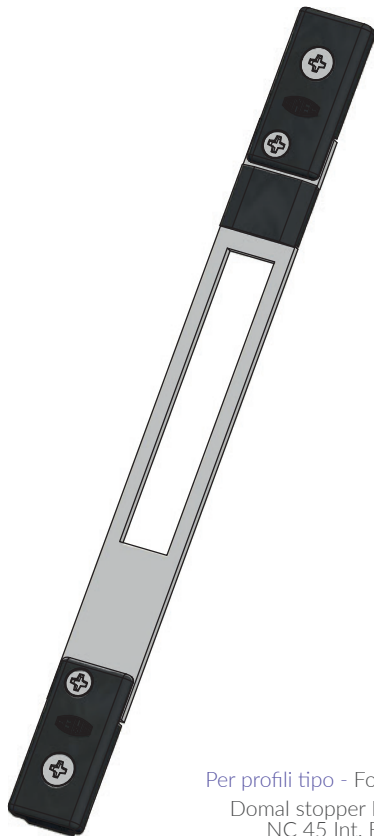

Per profili tipo - For profiles type
Domal stopper PG Finestra
NC 45 Int. Finestra

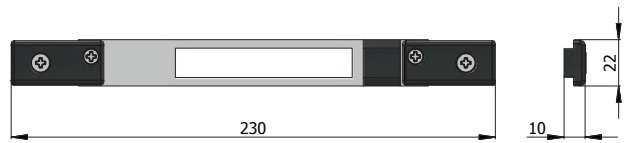

Per serrature serie - For locks series
11140 - 11141 - 11145 - 11170 - 11171 - 11175
1940 - 1941 - 1945 - 1970 - 1971 - 1975
41140 - 41141 - 41145 - 41170 - 41171 - 41175
4940 - 4941 - 4945 - 4970 - 4971 - 4975
5930 - 5931 - 5935 - 5938 - 5940 - 5941 - 5945 - 5948
5950 - 5951 - 5960 - 5961 - 5965 - 5968
5970 - 5971 - 5975 - 5978 - 5980 - 5981

COD.	Materiale - Material	kg		
02321 X	Acciaio inox - Stainless steel	0,126	10	-



Per profili tipo - For profiles type
Domal stopper PG Finestra
NC 45 Int. Finestra

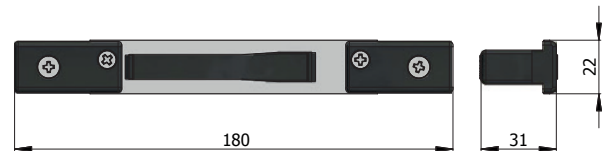

Per serrature serie - For locks series
1401S - 1411S
1501S
1601S - 1611S - 1621S - 1631S
1701S - 1721S - 1741S - 1761S

Per deviatori serie - For deviators series
0661S - 0761S

Per deviatori serrature multipunto ad ingranaggi
(tranne serie 1740S - 1760S)
For deviators of vertical multi-point locks with gear mechanism
movements (but series 1740S - 1760S)

COD.	Materiale - Material	kg		
02344 X	Acciaio inox - Stainless steel	0,123	10	-



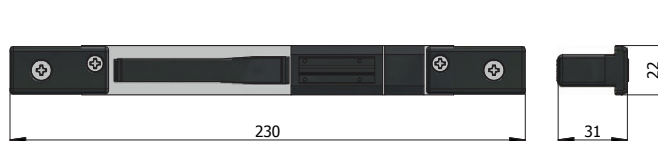

Per serrature serie - For locks series
1400S - 1405S - 1410S - 1415S
1500S - 1505S
1600S - 1605S - 1610S - 1615S
1620S - 1625S - 1630S - 1635S
1700S - 1705S - 1720S - 1725S
1740S - 1745S - 1760S - 1765S

Per profili tipo - For profiles type
Domal stopper PG Finestra
NC 45 Int. Finestra

COD.	Materiale - Material	kg		
02346 X	Acciaio inox - Stainless steel	0,138	10	-



Per deviatori serie - For deviators series
0766S

Per deviatori multipunto serie - For multi-point deviators series
1740S - 1741S - 1745S - 1760S - 1761S - 1765S

Per profili tipo - For profiles type
Domal stopper PG Finestra
NC 45 Int. Finestra

COD.	Materiale - Material	kg		
02349 X	Acciaio inox - Stainless steel	0,138	10	-

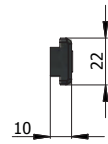
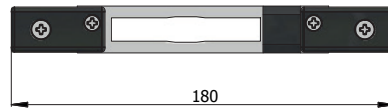

Per profili tipo - For profiles type
Domal stopper PG Finestra
NC 45 Int. Finestra

Per serrature serie - For locks series

- 1301
- 1770 - 1771 - 1775 - 1777 - 1780 - 1781 - 1785
- 327 - 334 - 335 - 337 - 339 - 351 - 354 - 355 - 357 - 359
- 370 - 371 - 375 - 377 - 378 - 380 - 381 - 385 - 388
- 390 - 391 - 395 - 399
- 4335 - 4339 - 4355 - 4531
- 531 - 541
- 770 - 771 - 775 - 777 - 778 - 780 - 781 - 782 - 785 - 788
- 790 - 791 - 795 - 799
- 870 - 871 - 875 - 877 - 878 - 880 - 881 - 882 - 885 - 888
- 890 - 891 - 895 - 899
- 990 - 991 - 995 - 999

COD.	Materiale - Material	kg		
02381 X	Acciaio inox - Stainless steel	0,112	10	-

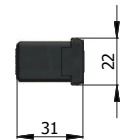

Per profili tipo - For profiles type
Domal stopper PG Finestra
NC 45 Int. Finestra

Per serrature serie - For locks series

- 1401 - 1411
- 1501
- 4401 - 4411

Per deviatori serie - For deviators series

- 0661 - 0662

Per deviatori multipunto catenaccio basculante
For deviators of multi-point locks with tipping dead bolt

COD.	Materiale - Material	kg		
02394 X	Acciaio inox - Stainless steel	0,118	10	-





Per serrature serie - For locks series

- 1300-1305
- 1400-1405-1408-1408Q-1409-1409Q-1410-1415-1418-1418Q
- 1500-1505-1508-1508Q
- 320-322-328-330-332-338-340-342-345-348-350-352-358
- 4320-4328-4330-4338-4340-4350
- 4400-4405-4408-4408Q-4409-4409Q-4410-4415-4418-4418Q
- 4530-4535
- 530-535-540-545

Per profili tipo - For profiles type
 Domal stopper PG Finestra
 NC 45 Int. Finestra

COD.	Materiale - Material	kg		
02396 X	Acciaio inox - Stainless steel	0,133	10	-

CONTROPIASTRE REGOLABILI IN ACCIAIO INOX
STAINLESS STEEL ADJUSTABLE STRIKING PLATES



SERIE 026 X

PER PROFILI TIPO
FOR PROFILES TYPE

- DOMAL BREAK PORTE 52
- NC65 STH PORTE
- EXPORT 50TT PORTE
- ALU - K 62TT PORTE

VITI INOX
STAINLESS STEEL
SCREWS

VASCHETTA GUIDA RULLO
ROLLER BOLT GUIDE

VASCHETTA COPRI-SPACCO
HOUSING COVER

PIASTRA INOX SATINATA
BRUSH-POLISHED
STAINLESS STEEL PLATE

REGOLAZIONE PROFONDITÀ
DEPHT ADJUSTMENT

REGOLAZIONE ORIZZONTALE
HORIZONTAL ADJUSTMENT

SPESSORI PER REGOLAZIONE PROFONDITÀ
DEPHT ADJUSTING SPACER

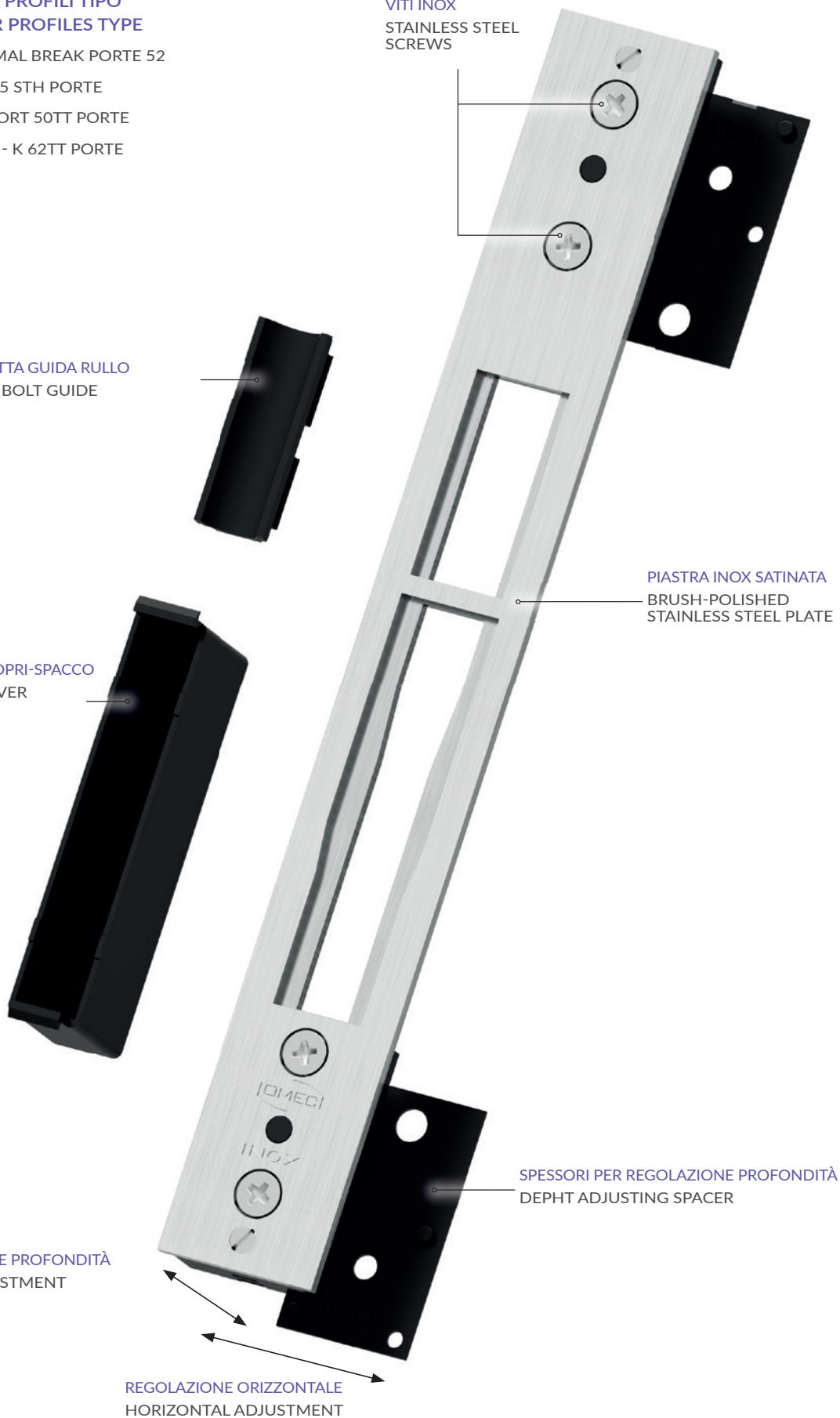

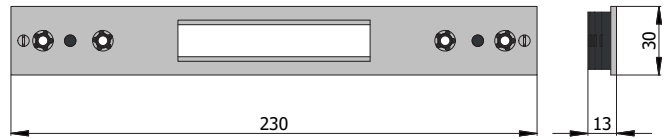
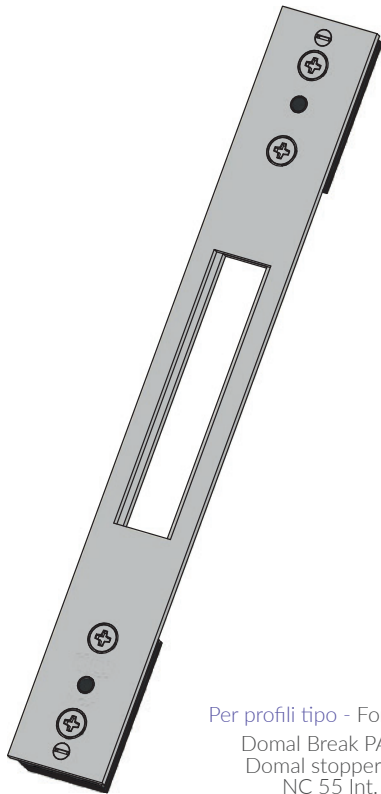

Per serrature serie - For locks series
11140 - 11141 - 11145 - 11170 - 11171 - 11175
1940 - 1941 - 1945 - 1970 - 1971 - 1975
41140 - 41141 - 41145 - 41170 - 41171 - 41175
4940 - 4941 - 4945 - 4970 - 4971 - 4975
5930 - 5931 - 5935 - 5938 - 5940 - 5941 - 5945 - 5948
5950 - 5951 - 5960 - 5961 - 5965 - 5968
5970 - 5971 - 5975 - 5978 - 5980 - 5981

Per profili tipo - For profiles type
Domal Break PA 52 Porta
Domal stopper PG Porta
NC 55 Int. Porta
NC 45 Int. Porta

COD.	Materiale - Material	kg		
02621 X	Acciaio inox - Stainless steel	0,193	10	-

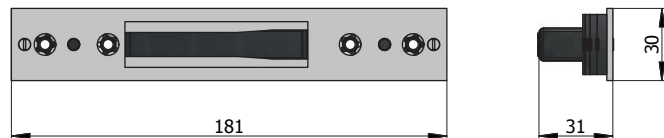

Per serrature serie - For locks series
1401S - 1411S
1501S
1601S - 1611S - 1621S - 1631S
1701S - 1721S - 1741S - 1761S

Per deviatori serie - For deviators series
0661S - 0761S

Per deviatori serrature multipunto ad ingranaggi
(tranne serie 1740S - 1760S)
For deviators of vertical multi-point locks with gear mechanism
movements (but series 1740S - 1760S)

Per profili tipo - For profiles type
Domal Break PA 52 Porta
Domal stopper PG Porta
NC 55 Int. Porta
NC 45 Int. Porta

COD.	Materiale - Material	kg		
02644 X	Acciaio inox - Stainless steel	0,160	10	-

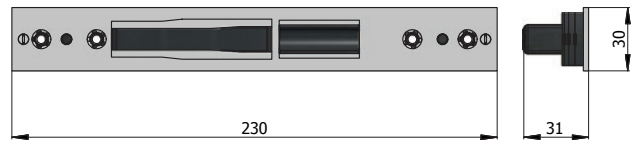

Per serrature serie - For locks series
1400S - 1405S - 1410S - 1415S
1500S - 1505S
1600S - 1605S - 1610S - 1615S
1620S - 1625S - 1630S - 1635S
1700S - 1705S - 1720S - 1725S
1740S - 1745S - 1760S - 1765S

Per profili tipo - For profiles type
Domal Break PA 52 Porta
Domal stopper PG Porta
NC 55 Int. Porta
NC 45 Int. Porta

COD.	Materiale - Material	kg		
02646 X	Acciaio inox - Stainless steel	0,188	10	-

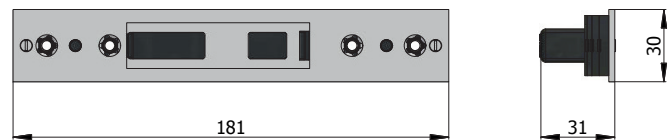

Per deviatori serie - For deviators series
0766S

Per deviatori multipunto serie - For multi-point deviators series
1740S - 1741S - 1745S - 1760S - 1761S - 1765S

Per profili tipo - For profiles type
Domal Break PA 52 Porta
Domal stopper PG Porta
NC 55 Int. Porta
NC 45 Int. Porta

COD.	Materiale - Material	kg		
02649 X	Acciaio inox - Stainless steel	0,188	10	-



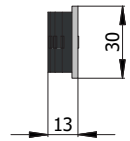
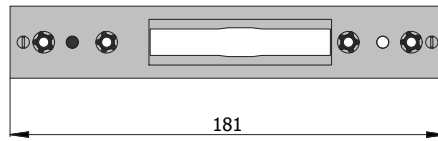
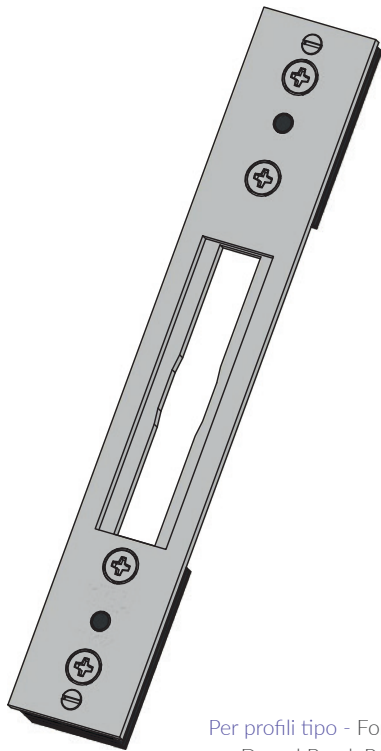

Per serrature serie - For locks series

- 1301
- 1770 - 1771 - 1775 - 1777 - 1780 - 1781 - 1785
- 327 - 334 - 335 - 337 - 339 - 351 - 354 - 355 - 357 - 359
- 370 - 371 - 375 - 377 - 378 - 380 - 381 - 385 - 388
- 390 - 391 - 395 - 399
- 4335 - 4339 - 4355 - 4531
- 531 - 541
- 770 - 771 - 775 - 777 - 778 - 780 - 781 - 782 - 785 - 788
- 790 - 791 - 795 - 799
- 870 - 871 - 875 - 877 - 878 - 880 - 881 - 882 - 885 - 888
- 890 - 891 - 895 - 899
- 990 - 991 - 995 - 999

Per profili tipo - For profiles type

- Domal Break PA 52 Porta
- Domal stopper PG Porta
- NC 55 Int. Porta
- NC 45 Int. Porta

COD.	Materiale - Material	kg		
02681 X	Acciaio inox - Stainless steel	0,150	10	-

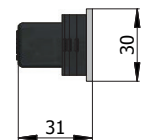
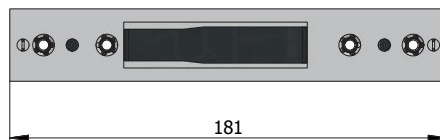

Per serrature serie - For locks series

- 1401 - 1411
- 1501
- 4401 - 4411

Per deviatori serie - For deviators series

- 0661 - 0662

Per deviatori multipunto catenaccio basculante

For deviators of multi-point locks with tipping dead bolt

Per profili tipo - For profiles type

- Domal Break PA 52 Porta
- Domal stopper PG Porta
- NC 55 Int. Porta
- NC 45 Int. Porta

COD.	Materiale - Material	kg		
02694 X	Acciaio inox - Stainless steel	0,155	10	-

CONTROPIASTRE REGOLABILI IN ACCIAIO INOX
STAINLESS STEEL ADJUSTABLE STRIKING PLATES

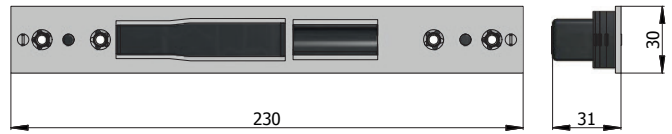

Per serrature serie - For locks series

- 1300-1305
- 1400-1405-1408-1408Q-1409-1409Q-1410-1415-1418-1418Q
- 1500-1505-1508-1508Q
- 320-322-328-330-332-338-340-342-345-348-350-352-358
- 4320-4328-4330-4338-4340-4350
- 4400-4405-4408-4408Q-4409-4409Q-4410-4415-4418-4418Q
- 4530-4535
- 530-535-540-545

Per profili tipo - For profiles type

- Domal Break PA 52 Porta
- Domal stopper PG Porta
- NC 55 Int. Porta
- NC 45 Int. Porta

COD.	Materiale - Material	kg		
02696 X	Acciaio inox - Stainless steel	0,183	10	-



CONTROPIASTRE REGOLABILI IN ACCIAIO INOX
STAINLESS STEEL ADJUSTABLE STRIKING PLATES



Spessore laterale per contropiastre cod.
 Lateral spacer for striking plates cod.
 02621 X - 02646 X - 02696 X

Per profili PORTE APERTURA ESTERNA tipo
 For external opening door profiles type

NC 65 STH
 ALUK 62 TT
 EURO LINE 60

COD.	Materiale - Material	kg		
0740 N	Nylon nero - Black nylon	0,026	10	-



Spessore laterale per contropiastre cod.
 Lateral spacer for striking plates cod.
 02644 X - 02649 X- 02681 X - 02694 X

Per profili PORTE APERTURA ESTERNA tipo
 For external opening door profiles type

NC 65 STH
 ALUK 62 TT
 EURO LINE 60

COD.	Materiale - Material	kg		
0741 N	Nylon nero - Black nylon	0,022	10	-

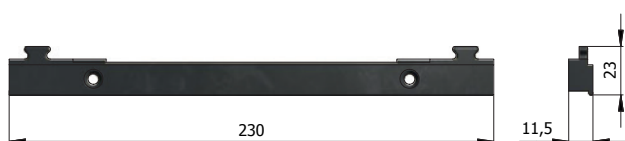

Spessore laterale per contropiastre cod.
 Lateral spacer for striking plates cod.
 02621 X - 02646 X - 02696 X

Per profili PORTE APERTURA ESTERNA tipo
 For external opening door profiles type

DOMAL BREAK 52
 NC 55 TH
 EXPORT 50 TT

COD.	Materiale - Material	kg		
0742 N	Nylon nero - Black nylon	0,038	10	-

CONTROPIASTRE REGOLABILI IN ACCIAIO INOX
STAINLESS STEEL ADJUSTABLE STRIKING PLATES

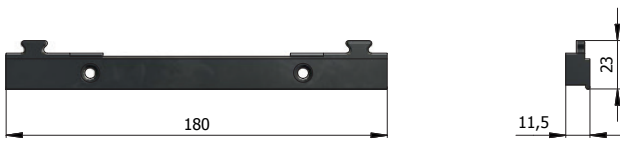

Spessore laterale per contropiastre cod.
 Lateral spacer for striking plates cod.
 02644 X - 02649 X - 02681 X - 02694 X

Per profili PORTE APERTURA ESTERNA tipo
 For external opening door profiles type
 DOMAL BREAK 52
 NC 55 TH
 EXPORT 50 TT

COD.	Materiale - Material	kg		
0743 N	Nylon nero - Black nylon	0,032	10	-



Spessore laterale per contropiastre cod.
 Lateral spacer for striking plates cod.
 02621 X - 02646 X - 02696 X

Per profili PORTE APERTURA ESTERNA tipo
 For external opening door profiles type
 ALUK 67IW

COD.	Materiale - Material	kg		
0744 N	Nylon nero - Black nylon	0,034	10	-



Spessore laterale per contropiastre cod.
 Lateral spacer for striking plates cod.
 02644 X - 02649 X - 02681 X - 02694 X

Per profili PORTE APERTURA ESTERNA tipo
 For external opening door profiles type
 ALUK 67IW

COD.	Materiale - Material	kg		
0745 N	Nylon nero - Black nylon	0,028	10	-



SERIE 028 X

PER PROFILI TIPO
FOR PROFILES TYPE

R 40
R 50
NEW - TEC

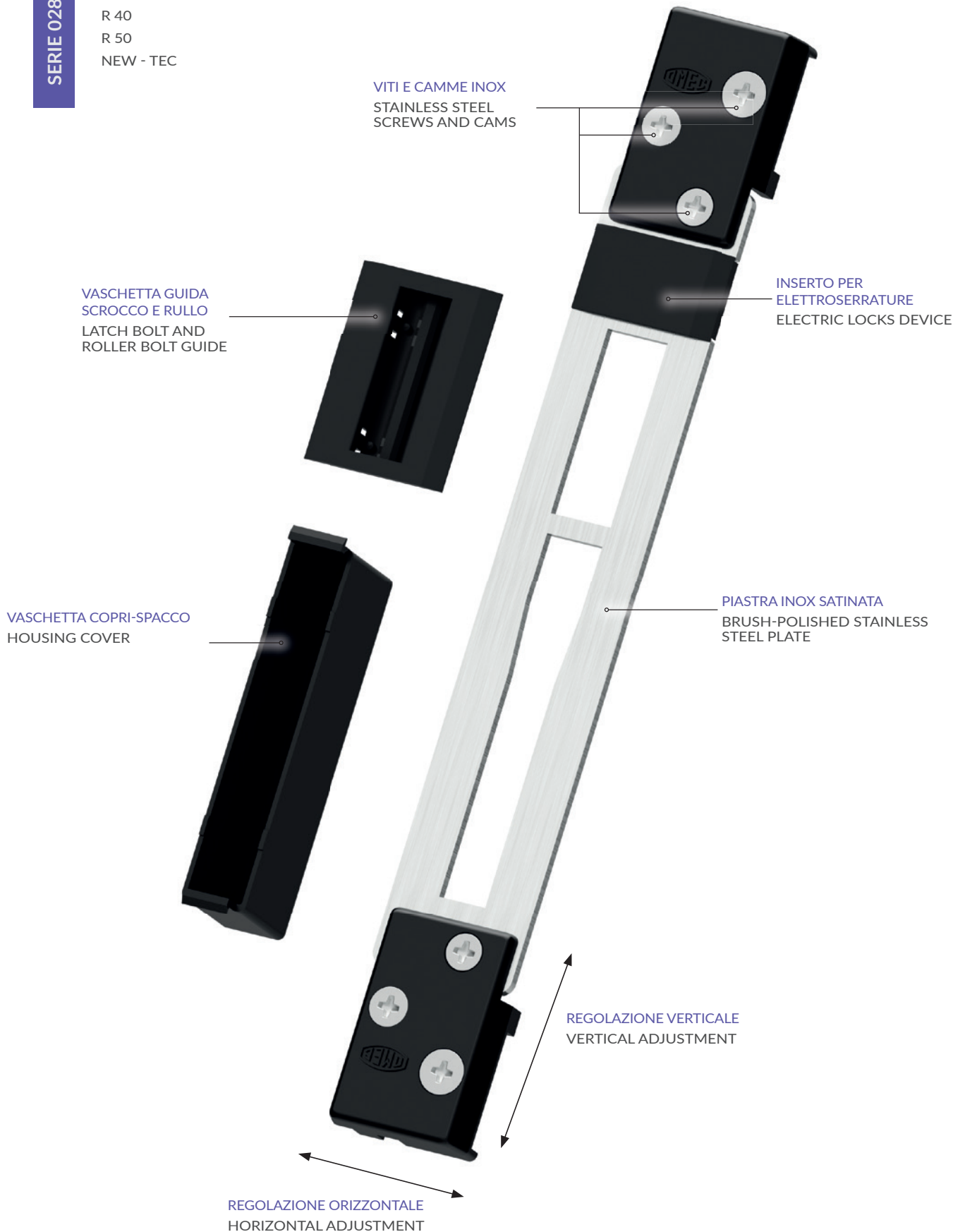

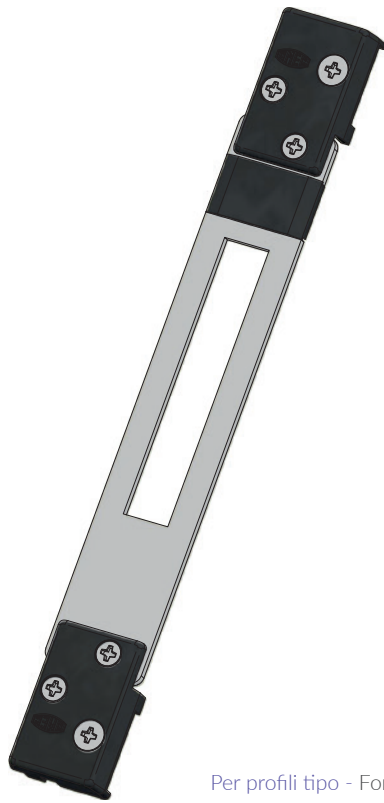

Per profili tipo - For profiles type
R 40, R 50

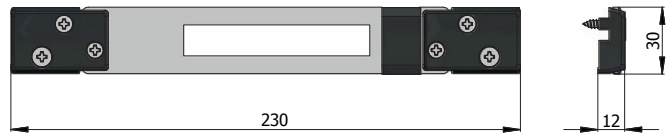

Per serrature serie - For locks series
11140 - 11141 - 11145 - 11170 - 11171 - 11175
1940 - 1941 - 1945 - 1970 - 1971 - 1975
41140 - 41141 - 41145 - 41170 - 41171 - 41175
4940 - 4941 - 4945 - 4970 - 4971 - 4975
5930 - 5931 - 5935 - 5938 - 5940 - 5941 - 5945 - 5948
5950 - 5951 - 5960 - 5961 - 5965 - 5968
5970 - 5971 - 5975 - 5978 - 5980 - 5981

COD.	Materiale - Material	kg		
02821 X	Acciaio inox - Stainless steel	0,180	10	-



Per profili tipo - For profiles type
R 40, R 50



Per serrature serie - For locks series
1401S - 1411S
1501S
1601S - 1611S - 1621S - 1631S
1701S - 1721S - 1741S - 1761S

Per deviatori serie - For deviators series
0661S - 0761S

Per deviatori serrature multipunto ad ingranaggi
(tranne serie 1740S - 1760S)
For deviators of vertical multi-point locks with gear mechanism
movements (but series 1740S - 1760S)

COD.	Materiale - Material	kg		
02844 X	Acciaio inox - Stainless steel	0,165	10	-





Per profili tipo - For profiles type
R 40, R 50



Per serrature serie - For locks series
1400S - 1405S - 1410S - 1415S
1500S - 1505S
1600S - 1605S - 1610S - 1615S
1620S - 1625S - 1630S - 1635S
1700S - 1705S - 1720S - 1725S
1740S - 1745S - 1760S - 1765S

COD.	Materiale - Material	kg		
02846 X	Acciaio inox - Stainless steel	0,190	10	-



Per profili tipo - For profiles type
R 40, R 50



Per deviatori serie - For deviators series
0766S
Per deviatori multipunto serie - For multi-point deviators series
1740S - 1741S - 1745S - 1760S - 1761S - 1765S

COD.	Materiale - Material	kg		
02849 X	Acciaio inox - Stainless steel	0,190	10	-



Per profili tipo - For profiles type
R 40, R 50

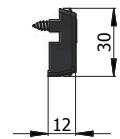
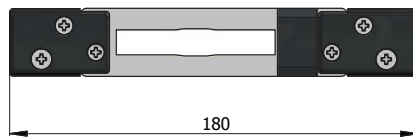

Per serrature serie - For locks series

- 1301
- 1770 - 1771 - 1775 - 1777 - 1780 - 1781 - 1785
- 327 - 334 - 335 - 337 - 339 - 351 - 354 - 355 - 357 - 359
- 370 - 371 - 375 - 377 - 378 - 380 - 381 - 385 - 388
- 390 - 391 - 395 - 399
- 4335 - 4339 - 4355 - 4531
- 531 - 541
- 770 - 771 - 775 - 777 - 778 - 780 - 781 - 782 - 785 - 788
- 790 - 791 - 795 - 799
- 870 - 871 - 875 - 877 - 878 - 880 - 881 - 882 - 885 - 888
- 890 - 891 - 895 - 899
- 990 - 991 - 995 - 999

COD.	Materiale - Material	kg		
02881 X	Acciaio inox - Stainless steel	0,154	10	-



Per profili tipo - For profiles type
R 40, R 50

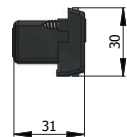
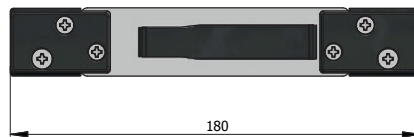

Per serrature serie - For locks series

- 1401 - 1411
- 1501
- 4401 - 4411

Per deviatori serie - For deviators series

- 0661 - 0662

Per deviatori multipunto catenaccio basculante
For deviators of multi-point locks with tipping dead bolt

COD.	Materiale - Material	kg		
02894 X	Acciaio inox - Stainless steel	0,160	10	-





Per profili tipo - For profiles type
R 40, R 50



Per serrature serie - For locks series

1300-1305
1400-1405-1408-1408Q-1409-1409Q-1410-1415-1418-1418Q
1500-1505-1508-1508Q
320-322-328-330-332-338-340-342-345-348-350-352-358
4320-4328-4330-4338-4340-4350
4400-4405-4408-4408Q-4409-4409Q-4410-4415-4418-4418Q
4530-4535
530-535-540-545

COD.	Materiale - Material	kg		
02896 X	Acciaio inox - Stainless steel	0,185	10	-

SERIE 030 X

PER PROFILI TIPO
FOR PROFILES TYPE

ALL.CO 5 SORMONTO

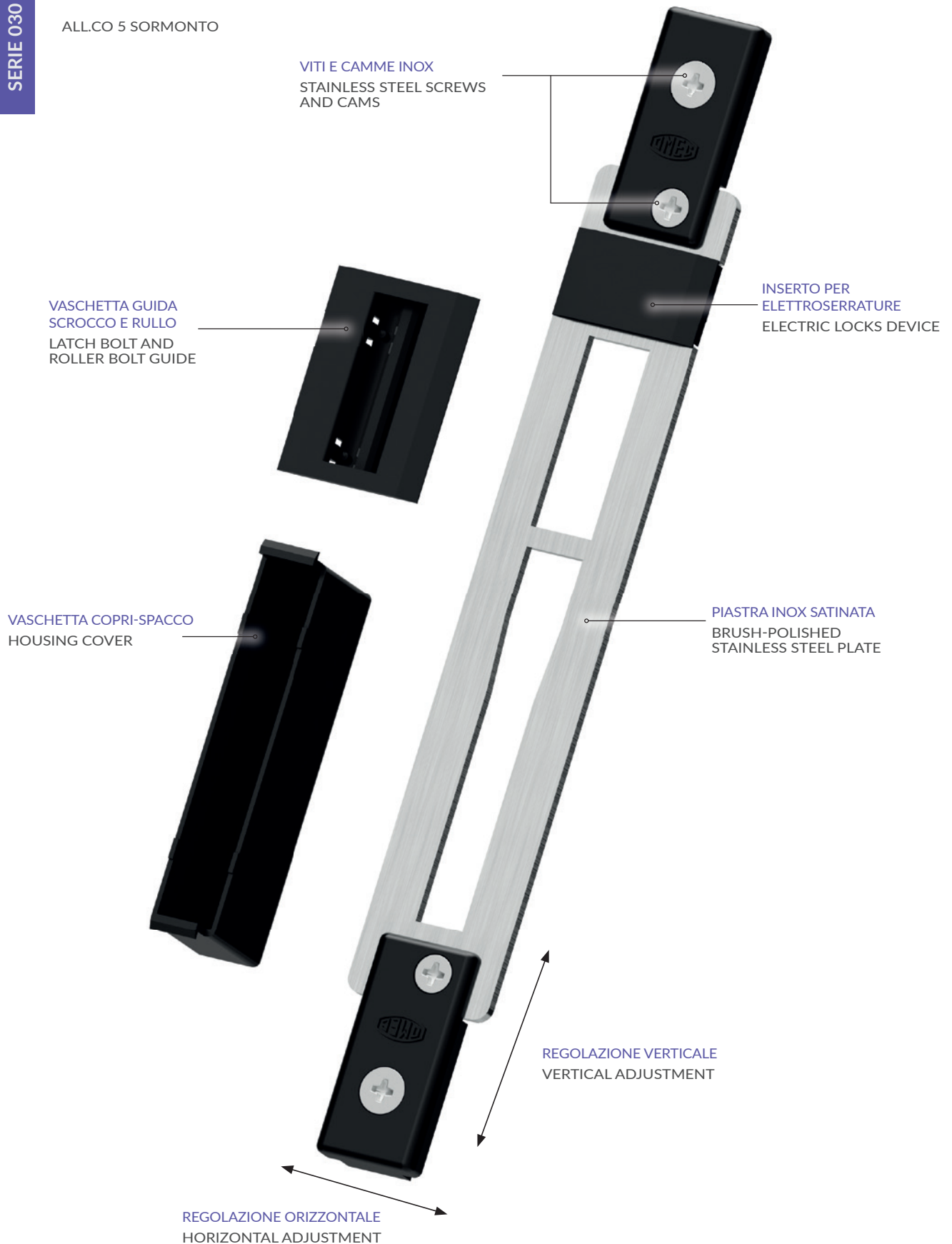

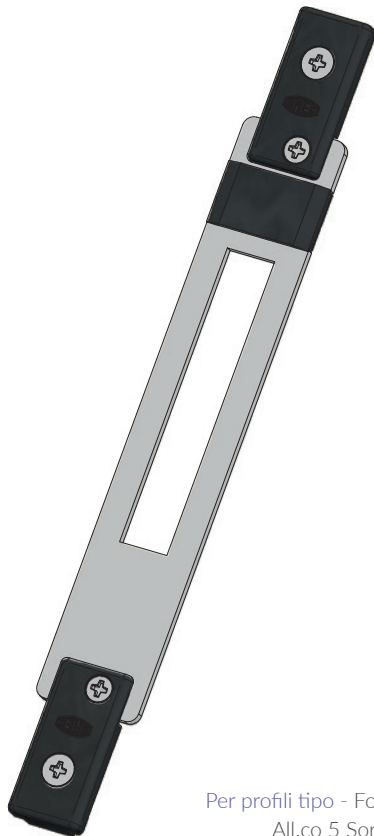

Per profili tipo - For profiles type
All.co 5 Sormonto

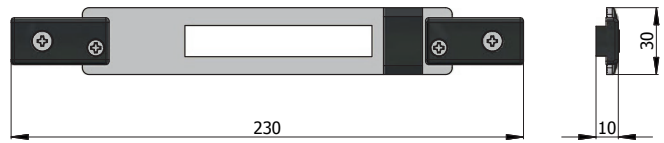

Per serrature serie - For locks series
11140 - 11141 - 11145 - 11170 - 11171 - 11175
1940 - 1941 - 1945 - 1970 - 1971 - 1975
41140 - 41141 - 41145 - 41170 - 41171 - 41175
4940 - 4941 - 4945 - 4970 - 4971 - 4975
5930 - 5931 - 5935 - 5938 - 5940 - 5941 - 5945 - 5948
5950 - 5951 - 5960 - 5961 - 5965 - 5968
5970 - 5971 - 5975 - 5978 - 5980 - 5981

COD.	Materiale - Material	kg		
03021 X	Acciaio inox - Stainless steel	0,148	10	-



Per profili tipo - For profiles type
All.co 5 Sormonto

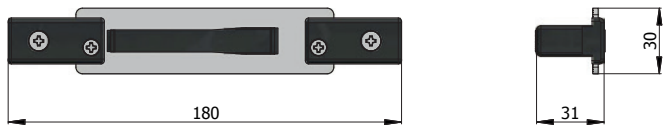

Per serrature serie - For locks series
1401S - 1411S
1501S
1601S - 1611S - 1621S - 1631S
1701S - 1721S - 1741S - 1761S

Per deviatori serie - For deviators series
0661S - 0761S

Per deviatori serrature multipunto ad ingranaggi
(tranne serie 1740S - 1760S)
For deviators of vertical multi-point locks with gear mechanism
movements (but series 1740S - 1760S)

COD.	Materiale - Material	kg		
03044 X	Acciaio inox - Stainless steel	0,137	10	-



Per profili tipo - For profiles type
 All.co 5 Sormonto



Per serrature serie - For locks series
 1400S - 1405S - 1410S - 1415S
 1500S - 1505S
 1600S - 1605S - 1610S - 1615S
 1620S - 1625S - 1630S - 1635S
 1700S - 1705S - 1720S - 1725S
 1740S - 1745S - 1760S - 1765S

COD.	Materiale - Material	kg		
03046 X	Acciaio inox - Stainless steel	0,165	10	-



Per profili tipo - For profiles type
 All.co 5 Sormonto

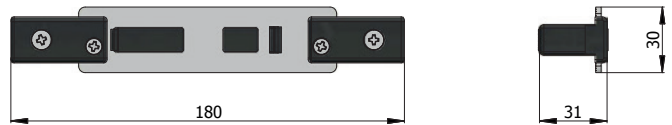

Per deviatori serie - For deviators series
 0766S

Per deviatori multipunto serie - For multi-point deviators series
 1740S - 1741S - 1745S - 1760S - 1761S - 1765S

COD.	Materiale - Material	kg		
03049 X	Acciaio inox - Stainless steel	0,165	10	-





Per profili tipo - For profiles type
All.co 5 Sormonto

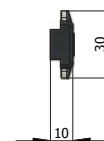
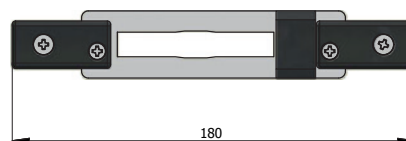

Per serrature serie - For locks series

1301
1770 - 1771 - 1775 - 1777 - 1780 - 1781 - 1785
327 - 334 - 335 - 337 - 339 - 351 - 354 - 355 - 357 - 359
370 - 371 - 375 - 377 - 378 - 380 - 381 - 385 - 388
390 - 391 - 395 - 399
4335 - 4339 - 4355 - 4531
531 - 541
770 - 771 - 775 - 777 - 778 - 780 - 781 - 782 - 785 - 788
790 - 791 - 795 - 799
870 - 871 - 875 - 877 - 878 - 880 - 881 - 882 - 885 - 888
890 - 891 - 895 - 899
990 - 991 - 995 - 999

COD.	Materiale - Material	kg		
03081 X	Acciaio inox - Stainless steel	0,128	10	-



Per profili tipo - For profiles type
All.co 5 Sormonto

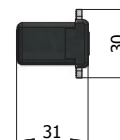
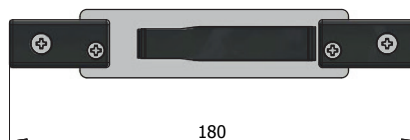

Per serrature serie - For locks series

1401 - 1411
1501
4401 - 4411

Per deviatori serie - For deviators series

0661 - 0662

Per deviatori multipunto catenaccio basculante

For deviators of multi-point locks with tipping dead bolt

COD.	Materiale - Material	kg		
03094 X	Acciaio inox - Stainless steel	0,132	10	-

CONTROPIASTRE REGOLABILI IN ACCIAIO INOX
STAINLESS STEEL ADJUSTABLE STRIKING PLATES



Per profili tipo - For profiles type
All.co 5 Sormonto

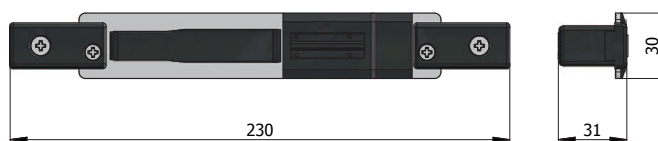

Per serrature serie - For locks series

1300-1305
1400-1405-1408-1408Q-1409-1409Q-1410-1415-1418-1418Q
1500-1505-1508-1508Q
320-322-328-330-332-338-340-342-345-348-350-352-358
4320-4328-4330-4338-4340-4350
4400-4405-4408-4408Q-4409-4409Q-4410-4415-4418-4418Q
4530-4535
530-535-540-545

COD.	Materiale - Material	kg		
03096 X	Acciaio inox - Stainless steel	0,160	10	-



